



HAL
open science

Unique ergodicity for infinite area Translation Surfaces

Alba Málaga Sabogal, Serge Troubetzkoy

► **To cite this version:**

Alba Málaga Sabogal, Serge Troubetzkoy. Unique ergodicity for infinite area Translation Surfaces. 2019. hal-02265283v1

HAL Id: hal-02265283

<https://hal.science/hal-02265283v1>

Preprint submitted on 9 Aug 2019 (v1), last revised 21 Jul 2023 (v2)

HAL is a multi-disciplinary open access archive for the deposit and dissemination of scientific research documents, whether they are published or not. The documents may come from teaching and research institutions in France or abroad, or from public or private research centers.

L'archive ouverte pluridisciplinaire **HAL**, est destinée au dépôt et à la diffusion de documents scientifiques de niveau recherche, publiés ou non, émanant des établissements d'enseignement et de recherche français ou étrangers, des laboratoires publics ou privés.

UNIQUE ERGODICITY FOR INFINITE AREA TRANSLATION SURFACES

ALBA MÁLAGA SABOGAL AND SERGE TROUBETZKOY

ABSTRACT. We consider infinite staircase translation surfaces with varying step sizes. For typical step sizes we show that the translation flow is uniquely ergodic in almost every direction. Our result also hold for typical configurations of the Ehrenfest wind-tree model endowed with the Hausdorff topology. In contrast, we show that the translation flow on a periodic translation surface can not be uniquely ergodic in any direction.

1. INTRODUCTION

One of the most fundamental results in the theory of (compact) translation surfaces is the theorem of Kerchhoff, Masur and Smillie which states that the geodesic flow on any compact translation surface is uniquely ergodic in almost every direction [KeMaSm]. The importance of this result is such that there are several articles explaining the proofs [Ar, GoLa, Mo] as well as [MaTa]). Since the result holds for all translation surfaces, it holds for translation surfaces arising from billiards in rational polygons.

In the past decade there has been intensive study of translation surface and polygonal billiards with infinite area. In particular, research has concentrated on trying to understand if the ergodicity conclusion of the Kerchhoff, Masur, Smillie theorem holds. There are examples of infinite billiard tables/translation surfaces which are not ergodic in almost every direction with respect to the natural invariant area measure [FrUl, FrHu], and others which are ergodic in almost every direction with respect to the natural invariant area measure [HoHuWe, HuWe, MSt2, RaTr] (see also [FrU11] for some partial results in this direction); certain of these examples are shown in Figure 1. There is a special class of (compact) translation surfaces called Veech surfaces, on a (compact) Veech surface each minimal direction is in fact uniquely ergodic [Ve1][Ve2]; and thus one might think that they are natural candidates for unique ergodicity in infinite area as well.

The project leading to this publication has received funding from Excellence Initiative of Aix-Marseille University - A*MIDEX and Excellence Laboratory Archimedes LabEx (ANR-11-LABX-0033), French "Investissements d'Avenir" programmes. Theorem 1 was inspired by a very nice lecture of Omri Sarig.

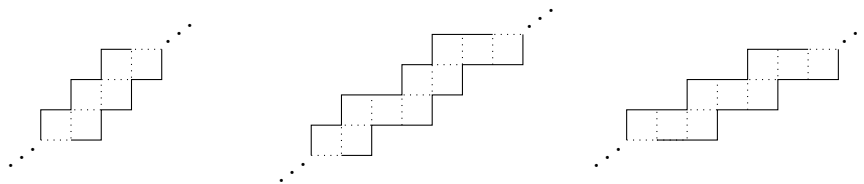

FIGURE 1. Periodic translation surfaces formed by identifying opposite sides. The first two are ergodic in almost every direction [HoHuWe, RaTr], while for the third the ergodic directions are of measure 0 [FrU].

This is not the case, it turns out that for the only known Veech example of an infinite area translation surface, the translation flow has many ergodic invariant Radon measures in almost every direction [HoHuWe]. Hooper has classified the invariant measures of the translation flow in many direction for certain other examples [Ho].

We begin by showing that the translation flow on a periodic translation surfaces can never be uniquely ergodic (Theorem 1). Our main result is that there are infinite area translation surfaces for which the area measure is the unique (up to scaling) invariant ergodic Radon measure for the translation flow in almost every direction. We present our results in two different settings, first for infinite staircases (Theorem 3), and then in the framework of the Ehrenfest wind-tree model (Theorem 4). In both cases we show that the generic surface satisfies this unique ergodicity result. We remark that unique ergodicity has been observed for non-compact translation surfaces of finite area by Hooper [Ho] as well as by Rafi and Randecker [RaRa], however in this case we have classical finite measure unique ergodicity.

2. DEFINITIONS AND MAIN RESULTS

2.1. Ergodic theory. Let T be a measurable map on a measurable space (Ω, \mathcal{B}) , and suppose μ is a σ -finite measure on (Ω, \mathcal{B}) s.t. $\mu(\Omega) = \infty$. We say that μ is *invariant*, if $\mu(T^{-1}(E)) = \mu(E)$ for all $E \in \mathcal{B}$. We say that μ is *ergodic*, if for every set $E \in \mathcal{B}$ such that $T^{-1}(E) = E$ either $\mu(E) = 0$ or $\mu(\Omega \setminus E) = 0$.

Suppose Ω_0 is a locally compact second countable metric space with Borel σ -algebra \mathcal{B}_0 . Let $C_c(\Omega_0) := \{f : \Omega_0 \rightarrow \mathbb{R} : f \text{ continuous with compact support}\}$. A regular Borel measure μ on Ω_0 is called a *Radon measure*, if $\mu(C) < \infty$ for every compact set $C \subset \Omega_0$,

We will need to deal with Borel maps T which are only defined on a subset $\Omega \subset \Omega_0$ with $\Omega \in \mathcal{B}_0$.

Let $\mathcal{B} := \{E \cap \Omega : E \in \mathcal{B}_0\}$. A measure μ on (Ω, \mathcal{B}) is called *locally finite*, if $\mu_0(E) := \mu(E \cap \Omega)$ is a Radon measure on $(\Omega_0, \mathcal{B}_0)$.

We call the map T *uniquely ergodic* if up to scaling, T admits a unique Radon invariant measure.

2.2. Periodic translation surfaces. A translation surface M is given by an at most countable index set Λ and a disjoint collection of convex polygons $\{P_i \subset \mathbb{R}^2\}_{i \in \Lambda}$ with edges glued in pairs by translation. The surface is compact if the set Λ is finite.

Let M be a compact translation surface; $p : \tilde{M} \rightarrow M$ is a \mathbb{Z} -cover of M of translation surfaces, i.e., \tilde{M} a (noncompact) translation surface, there is a finite set $P \subset M$ and a covering map $p : \tilde{M} \setminus p^{-1}(P) \rightarrow M \setminus P$ which is a triangulation in each chart, and there is a translation automorphism $S : \tilde{M} \rightarrow \tilde{M}$ commuting with p , such that M is isomorphic to $\tilde{M}/\langle S \rangle$.

In a similar way, $p : \tilde{M} \rightarrow M$ is a \mathbb{Z}^2 -cover of M if there is a finite set $P \subset M$ as above, and there are two translation automorphisms $S, S' : \tilde{M} \rightarrow \tilde{M}$, non aligned with each other and commuting with p , such that M is isomorphic to $\tilde{M}/\langle S, S' \rangle$.

We call a noncompact translation surface a *periodic translation surface* if it is a \mathbb{Z}^d cover of a compact translation surface ($d = 1$ or 2).

Theorem 1. *For every direction θ , the translation flow on a periodic translation surface in the direction θ is not uniquely ergodic.*

2.3. Staircases. A *staircase translation surface* or simply a staircase is a translation surface obtained by gluing an enumerated, ordered, collection of same size rectangles, say 2 by 1, all of whose sides are parallel to the coordinate axes in the following way. We place a rectangle in the plane with the center of the rectangle at the origin, label it as the 0th rectangle. The bottom of first rectangle will intersect the top of the 0th rectangle with length of intersection $w_0 \in (0, 1)$. Choosing a sequence $w := \{w_i \in (0, 1) : i \in \mathbb{Z}\}$, we continue this procedure inductively to produce a staircase like collection of rectangles. Then we identify opposite sides of the staircase to form a translation surface which we will call S_w (see Figure 2). Note that corners of the rectangles give rise to conical points. Every such corner, considered as a point on the staircase surface, is a conical point with angle 6π .

The set of all staircases is then coded by the set $(0, 1)^{\mathbb{Z}}$. We consider the product topology on this space, its closure is $[0, 1]^{\mathbb{Z}}$, a Baire space. In the proof we will also consider parameters $w \in [0, 1]^{\mathbb{Z}}$. In the case $w_n = 0$ for some n , after removing the singular points S_w is not connected. These non-connected staircases will play a very important role in the proof.

Fix a direction θ and consider the translation flow $\psi_t^\theta = \psi_t^{\omega, \theta}$ on the surface S_w . It will be convenient to use the section of this flow defined by intersecting S_w with the collections of lines $y = n$ where $n \in \mathbb{Z}$, we identify this section with the set $X := \mathbb{Z} \times [0, 2)$. Note that in S_w

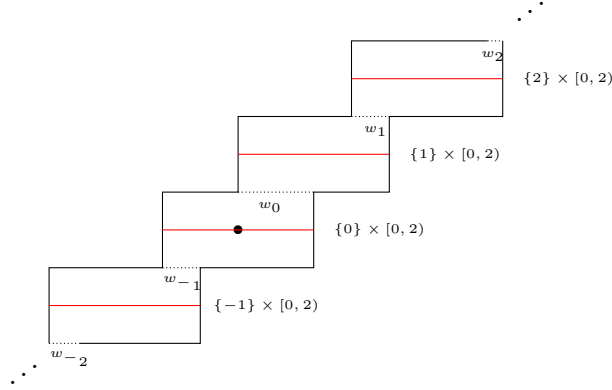

FIGURE 2. The staircase, opposite sides are identified. The section X is marked in red.

the points 0 and 2 are identified, thus each set $\{n\} \times [0, 2) \subset X$ is a circle. After the identification, the set X does not depend on the parameter ω , but sometimes we need to emphasize the nature of this sets as phase spaces for dynamical systems, we will then write X^ω . Let $X^N = X^{\omega, N} \subset X^\omega$ denote the set $X^N := \{-N + 1, \dots, N\} \times [0, 2)$. Likewise, the sets do not depend on the direction θ chosen, when needed for clarity we sometimes write X^θ or $X^{\omega, \theta}$.

Let $T^\theta = T^{\omega, \theta}$ be the first return map of the flow ψ_t^θ to the section X . Note that T^θ preserves the length measure μ , and that this measure is an infinite measure.

Proposition 2. *For any ω such that $\lim_{i \rightarrow \pm\infty} w_i = 0$, $(T^{\omega, \theta}, X, \mu)$ is a conservative system for all θ .*

This proposition is closely related to results in [Tr, MS, MSTR1, MSTR2]. We still provide a proof for completeness (§6.1). We remark that the set of ω satisfying this condition is a G_δ set.

Theorem 3. *There is a dense G_δ subset G of $[0, 1]^\mathbb{Z}$ and a dense G_δ set of full measure of directions \mathcal{H} , such that for each $w \in G$, we have $w \in (0, 1)^\mathbb{Z}$ and, up to scaling, μ is the unique T^θ -invariant ergodic Radon measure, for every $\theta \in \mathcal{H}$.*

It follows that, up to scaling, the area measure is the unique ψ_t^θ -invariant ergodic Radon measure, for every $\theta \in \mathcal{H}$.

2.4. Wind-trees. In the wind-tree model a point particle moves without friction on the plane with at most infinitely many rhombi removed, and collides elastically with the rhombi. This model was introduced by Paul and Tatiana Ehrenfest in 1912 in their a seminal article on the foundations of Statistical Mechanics in order to interpret the work of Boltzmann and Maxwell on gas dynamics [EhEh].

A square whose sides are parallel to lines $y = \pm x$ will be referred to as *rhombus* or *tree*. The \mathcal{L}_1 distance in \mathbb{R}^2 will be denoted by d . Note that balls with respect to this distance are rhombi.

Fix $s > 0$. A *configuration* is an at most countable collection of rhombi with diameter s , whose interiors are pairwise disjoint. Since s is fixed it is enough to note the centers of the rhombi, thus a configuration g is an at most countable subset of \mathbb{R}^2 such that if $z_1, z_2 \in g$ then $d(z_1, z_2) \geq s$.

To define a topology on the set of configurations consider polar coordinates (r, θ) on the plane. Each point (r, θ) in the plane is the stereographic projection of a point in the sphere with spherical coordinates $(2 \arctan(1/r), \theta)$. Apply the inverse of the stereographic projection to a configuration g to obtain a subset of the sphere. Let \hat{g} denote the union of this set with the north pole of the sphere denoted by $\{\infty\}$, it is a closed subset of the sphere. The topology we define on the set of configurations is then induced by the Hausdorff distance d_H on the sphere given by

$$d_H(g_1, g_2) = \max\left(\sup_{z_1 \in \hat{g}_1} \inf_{z_2 \in \hat{g}_2} \rho(z_1, z_2), \sup_{z_2 \in \hat{g}_2} \inf_{z_1 \in \hat{g}_1} \rho(z_1, z_2)\right).$$

Here ρ denotes the geodesic distance on the sphere, i.e., the length of the shortest path from one point to another along the great circle passing through them.

Let $Conf$ be the set of all configurations. In [MSTr3], we show that $(Conf, d_H)$ is a compact metric space, thus a Baire space.

Fix $g \in Conf$. The *wind-tree table* \mathcal{B}^g is the plane \mathbb{R}^2 with the interiors of the union of the trees removed. Fix $\theta \in \mathbb{S}^1$. The *billiard flow* $\phi_t^{g, \theta}$ in the direction θ is the free motion in the interior of \mathcal{B}^g with elastic collision from the boundary of \mathcal{B}^g (the boundary of the union of the trees). If a billiard orbit hits a corner of a tree, the outcome of the collision is not defined, and we agree that the billiard orbit stops there, its future is not defined anymore. Let $T^{g, \theta}$ be the first return map of the flow $\phi_t^{g, \theta}$ to the boundary. We will sometime suppress the g dependance of certain notations if it can be deduced from the formulae, for example we might write T^θ for $T^{g, \theta}$.

Throughout the wind-tree argument we will always suppose that θ is not parallel to the rhombi sides. Once launched in the direction θ , the billiard direction can achieve four directions $[\theta] := \{\theta, \frac{3}{2}\pi - \theta, \pi + \theta, \frac{1}{2}\pi - \theta\}$; thus the *phase space* $X^{g, \theta}$ of the billiard map in the direction θ is the set of pairs (\mathfrak{s}, ϕ) such that at $\mathfrak{s} \in \partial\mathcal{B}^g$ the direction ϕ points to the interior of the table, i.e. away from the trees. Note that in this notation $T^\theta, T^{\frac{3}{2}\pi - \theta}, T^{\pi + \theta}$ and $T^{\frac{1}{2}\pi - \theta}$ are all the same.

For each direction θ , the billiard map T^θ preserves the length measure μ on $\partial\mathcal{B}^g$ times the discrete measure on $[\theta]$, we will also call this measure μ . Note that μ is an infinite measure.

Theorem 4. *For any $s > 0$ there is a dense G_δ subset G of Conf and a dense G_δ set of full measure of directions \mathcal{H} , such that for each $g \in G$, up to scaling, the length measure μ is the unique T^θ -invariant ergodic measure, for every $\theta \in \mathcal{H}$.*

Note that for each $g \in G$, up to scaling, the area measure is thus the unique $\varphi_t^{g,\theta}$ -invariant ergodic measure, for every $\theta \in \mathcal{H}$.

2.5. Generalizations. Our results hold in a much more general setting. In particular they hold in any Baire space X of infinite area translation surfaces such that

- (1) the set $\{S \in X : \text{there is a compact translation surface } S^{comp} \subset S\}$ contains a dense countable set \mathcal{S} ,
- (2) suppose $(S_i) \subset \mathcal{S}$ converges sufficiently quickly to a surface $S \notin \mathcal{S}$, then S_i^{comp} converges to S , and S is connected.

The proof of our results in this more general setting are essentially identical to the proofs of Theorems 3 and 4, we choose not to present an abstract proof for readability issues.

We list some examples of other situations where our theorems hold.

1) Billiards. Theorem 3 also holds if we change the staircase dynamics to billiard dynamics, i.e., we do not identify the opposite sides of the staircase, and the flow collides elastically when reaching the boundary.

More generally fix an arbitrary rational polygon P . We can construct a staircase like billiard table from P , which we call an *infinite polygon*, by choosing two sides of P and a sequence of lengths $\omega_n \in [0, a]$ where $a > 0$ is the shorter of the two lengths of the chosen sides. We then construct the infinite polygon in an analogous way to the construction of staircase. We can also start with a countable collection of rational polygons P_n , each with a pair of marked sides (s_1^n, s_2^n) . Let a_n be the minimum of the lengths of s_2^n, s_1^{n+1} . Then glue them as above with intersection $\omega_n \in [0, a_n]$.

2) Generalized staircases (see Figure 3). Take a countable enumerated collection of compact translation surfaces S_n . Consider a sequence $\omega_n \in [0, 1]$. On S_n we draw two parallel, non-intersecting segments of length ω_n and ω_{n+1} . Then we construct an infinite generalized staircase by gluing the slits of length ω_n in the following sense, i.e., when the flow arrives at a slit in S_n , then it jumps to the glued slit in S_{n+1} and continues in the same direction. To make the notion of same direction precise we consider a polygonal representation of each $S_n \subset \mathbb{R}^2$ with the slits horizontal, then if we hit a slit from the bottom on S_n we exit from the top of the slit on S_{n+1} .

3) Wind-trees. In two previous articles we have considered a subset of configurations which are small perturbations of lattice configurations, and we showed that the generic wind-tree is minimal and ergodic in almost every direction [MSTr1, MSTr2]. The proofs of these two results hold *mutatis mutandis* in the more general settings (staircases

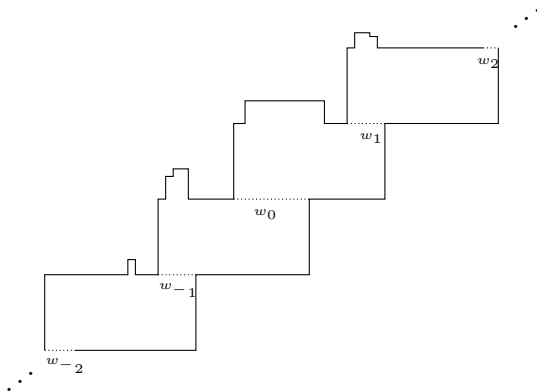

FIGURE 3. A generalized staircase (obvious identifications hold)

and wind-trees) which we consider here. The results from the present paper hold in this setting as well.

2.6. Comparison to other definitions of unique ergodicity. In his survey article [Sa] Sarig defines two notions of unique ergodicity in the infinite measure setting which are stronger than the one we prove.

A point $x \in \Omega$ is called *generic* for μ if for all $f, g \in C_c(\Omega)$ such that $g \geq 0$ and $\int g d\mu > 0$ we have

$$\frac{\sum_{k=0}^{\ell} f(T^k(x))}{\sum_{k=0}^{\ell} g(T^k(x))} \rightarrow \frac{\int_{\Omega} f(y) d\mu(y)}{\int_{\Omega} g(y) d\mu(y)}.$$

Sarig calls a map T *uniquely ergodic* if (1) up to scaling, T admits a unique Radon invariant measure not supported on a single orbit; and (2) every point is generic for this measure.

This strong version of unique ergodicity does not hold in either of our settings. In fact, in [MSTr1] we showed that the existence of non-recurrent points, this result holds in all the settings we consider here, thus (2) can not hold.

Sarig calls a map T *uniquely ergodic in the broad sense* if (1) up to scaling, T admits a unique Radon ergodic invariant measure not supported on a single orbit; and (2) every non-exceptional non-periodic point is generic for this measure (see [Sa]).

Here a point x is called (forward) *exceptional* for a map T if the measure $\sum_{n>0} \delta_{T^n(x)}$ is locally finite, where δ_y denote the point mass at y .

We do not know if the proofs of Theorems 3 and 4 can be strengthened to show unique ergodicity in the broad sense.

3. NON-UNIQUE ERGODICITY

Let $\tau : I \rightarrow I$ be a uniquely ergodic (finite) interval exchange transformation. Let $d = 1$ or 2 and let $\psi : I \rightarrow \mathbb{Z}^d$ be a function which is locally constant, with a finite set of discontinuities. Let $X = I \times \mathbb{Z}^d$ and consider the skew product $T : X \rightarrow X$ defined by $T(x, \vec{n}) = (\tau(x), \vec{n} + \psi(x))$.

The map T is an infinite interval exchange transformation. Note that for any \mathbb{Z} or \mathbb{Z}^2 periodic translation surface, the first return map will be of this form for almost every direction. This is in particular true for the periodic staircases and periodic wind tree models.

Let $h : I \rightarrow \mathbb{R}_+$ be a Borel measurable map. A Borel probability measure μ on I is called an (h, τ) -conformal measure if $\mu \circ \tau$ is absolutely continuous with respect to μ and the Radon-Nikodym derivative satisfies $\frac{d\mu \circ \tau}{d\mu}(x) = h(x)$ for μ -a.e. $x \in I$.

Let $\chi : \mathbb{Z}^d \rightarrow \mathbb{R}$ be a group homomorphism, and μ_χ a $(e^{\chi \circ \psi}, \tau)$ -conformal measure. For each $\vec{n} \in \mathbb{Z}^d$, consider the map $\pi_{\vec{n}} : I \rightarrow I \times \mathbb{Z}^d$ given by $\pi_{\vec{n}}(x) = (x, \vec{n})$. A measure m_χ on $I \times \mathbb{Z}^d$ is called the χ -Maharam measure associated to τ , μ_χ and χ if it satisfies the equation $m_\chi \circ \pi_{\vec{n}} = \frac{1}{e^{\chi(\vec{n})}} \mu_\chi$.

Lemma 5. *In this context Maharam measures always exist, are locally finite, and are invariant under the skew product transformation T .*

Proof. Passing to the Cantor representation (refined so that ψ is continuous), and applying Theorem 4.1 in [Sc] yields that $(e^{\chi \circ \psi}, \tau)$ -conformal measure exists in the Cantor representation. The push down μ_χ of this measure to X is also a conformal measure. The Maharam measure m_χ associated to τ , μ_χ and χ is given by the following,

$$dm_\chi(x, \vec{n}) := e^{-\chi(\vec{n})} d\mu_\chi(x).$$

Maharam measures are locally finite since

$$m_\chi(I \times \{\vec{n}\}) = e^{-\chi(\vec{n})} \times \mu_\chi(I) = e^{-\chi(\vec{n})} < \infty$$

for any $\vec{n} \in \mathbb{Z}^d$.

The measure is T -invariant since the scaling factor of χ from $(e^{\chi \circ \psi}, \tau)$ -conformality cancels with the $\frac{1}{e^\chi}$ factor arising from the change in the \mathbb{Z}^d -coordinate. \square

Proof of Theorem 1. Suppose that the direction is such that τ is not uniquely ergodic. The product of each τ -ergodic measure with the counting measure on \mathbb{Z}^d is a T -invariant locally finite measure, these measures are not rescalings of one another.

Suppose now that τ is uniquely ergodic. For each $a \in \mathbb{R}$ consider the group homomorphism $\chi_a(n) = na$ in the case $d = 1$ and $\chi_a(\vec{n}) = a(n_1 + n_2)$ in the case $d = 2$ with $\vec{n} = (n_1, n_2)$. Consider the associated

$(e^{\chi_a \circ \psi}, \tau)$ -conformal measure μ_a , it satisfies $\frac{d\mu_a \circ \tau}{d\mu_a}(x) = e^{\chi_a \circ \psi(x)}$ for μ_a -a.e. $x \in I$ and the associated Maharam measure m_a satisfies

$$dm_a(x, \vec{n}) := e^{-\chi_a(\vec{n})} d\mu_a(x).$$

The measure m_a is a locally finite measure. Suppose that m_a is ergodic for at least two values of a , then it suffices to notice that if $a \neq b$ then χ_a and χ_b are not rescalings of one another. On the other hand if m_a is not ergodic for some (all but one) $a \in \mathbb{R}$ then, since the ergodic decomposition of a locally finite measure is into locally finite measures we are also done. \square

The general program to study Maharam measures was proposed in a much more general setting in [AaNiSaSo]. The aim of this program is to classify all the ergodic measures of the associated skew products, this is in general difficult and has been achieved only for special base maps. In particular, in the frame work of translation surfaces such a classification has been achieved for certain infinite translation surfaces in [HuWe] and [Ho].

4. PROOF OF THE STAIRCASE RESULT

Proof of Theorem 3. Throughout the proof we will occasionally confound the parameter ω with the staircase S_ω .

The strategy of the proof is as follows: we choose a dense set $\{S_{\omega^i}\}$ of staircases which satisfy the goal dynamical property of unique ergodicity in almost every direction on compact sets which exhaust the staircase. The parameter of these staircases will satisfy $\omega \in [0, 1]^{\mathbb{Z}} \setminus (0, 1)^{\mathbb{Z}}$. Then we will show that staircases which are sufficiently well approximated by this dense set will satisfy the goal dynamical property on the whole phase space.

A staircase S_ω is *N-ringed* if $w_N = w_{-N} = 0$ and $w_j \notin \{0, 1\}$ for all $|j| < N$ (the name ringed comes from the corresponding topologically more complicated definition for wind-tree configurations). We will consider the dynamics on the set X^N , i.e., inside the ring, the set $X \setminus X^N$ plays no role in our proof.

Let $\{\omega^i\}$ be a dense set of parameters such that each S_{ω^i} is an N_i -ringed configuration, with N_i increasing with i .

By [KeMaSm] the translation flow is uniquely ergodic (in the classical finite measure sense) in almost every direction inside the ring, and thus the map $T^{\omega^i, \theta}|_{X^N}$ is also uniquely ergodic in almost every direction. To transfer this finite area unique ergodicity to sufficiently well approximable generic staircases, we suppose that δ_i are strictly positive numbers and consider the dense G_δ set

$$\mathcal{G} := \bigcap_{m=1}^{\infty} \bigcup_{i=m}^{\infty} \mathcal{U}_{\delta_i}(\omega^i).$$

We will show that the δ_i can be chosen in such a way that $\mathcal{G} \subset (0, 1)^{\mathbb{Z}}$ (i.e., the staircases in \mathcal{G} are connected), and all the staircases in \mathcal{G} have a unique (up to scaling) Radon T^θ -invariant ergodic measure for all $\theta \in \mathcal{H}$, where \mathcal{H} is a G_δ set of full measure that will be constructed in the proof.

For each $N \in \mathbb{N}$ let

$$\{h_j^N : X^N \rightarrow \mathbb{R}\}_{j \geq 1}$$

be a countable collection of continuous, strictly positive functions which are dense with respect to the sup norm in the set of all continuous non-negative functions. We can think of h_j^N as a function with compact support defined on X . We choose an enumeration $\{h_j\}_{j \geq 1}$ of the set $\cup_{j,n} \{h_j^N\}$. By construction, this collection is dense with respect to the sup norm in the set of all continuous non-negative functions on X .

Fix a surface S_ω , a direction $\theta \in \mathbb{S}^1$, a point $z \in X$, and $(j, n) \in \mathbb{N}^2$. Consider the Hopf average

$$H_{j,n,\ell}^{\omega,\theta}(z) := \frac{\sum_{k=0}^{\ell} h_j((T^{\omega,\theta})^k(z))}{\sum_{k=0}^{\ell} h_n((T^{\omega,\theta})^k(z))}.$$

Our strategy is to study unique ergodicity via Hopf averages. We start with the ringed configuration ω^i . We consider the Hopf averages of a finite subcollection of the $\{h_j\}$ and the times ℓ_i where these averages almost converge. We will show that for a small perturbation S_ω of S_{ω^i} , for many directions, for each point z either the forward or the backward orbit segment of length ℓ_i stays close enough to a good orbit on S_{ω^i} to control the Hopf averages on S_ω . Since for a dense G_δ this behavior happens on infinitely many scales, we can conclude that the forward or the backward Hopf average converges to the ratio of the integrals with respect to Lebesgue measure. Then we apply the following criterion for unique ergodicity.

Lemma 6. *Fix $\omega \in (0, 1)^{\mathbb{Z}}$, $\theta \in \mathbb{S}^1$. Suppose that there exists an increasing sequence ℓ_k tending to infinity such that for each $z \in X$ either*

$$\begin{aligned} \lim_{k \rightarrow \infty} H_{j,n,\ell_k}^{\omega,\theta}(z) &= \frac{\int_X h_j(y) d\mu(y)}{\int_X h_n(y) d\mu(y)} \quad \forall (j, n) \in \mathbb{N}^2 \text{ or} \\ \lim_{k \rightarrow \infty} H_{j,n,-\ell_k}^{\omega,\theta}(z) &= \frac{\int_X h_j(y) d\mu(y)}{\int_X h_n(y) d\mu(y)} \quad \forall (j, n) \in \mathbb{N}^2, \end{aligned}$$

then, up to scaling, there exists at most one conservative, $T^{\omega,\theta}$ -invariant, ergodic, Radon measure; if it exists it is the measure μ .

Proof. Suppose that m is a conservative, $T^{\omega,\theta}$ -invariant, ergodic Radon measure. Fix n , by assumption we have $\int_X h_n(y) d\mu(y) > 0$ and $\int_X h_n(y) dm(y) > 0$. By the Hopf ergodic theorem, for every $j \in \mathbb{N}$

and m -a.e. $z \in X$ we have

$$\lim_{\ell \rightarrow \infty} H_{j,n,\ell}^{\omega,\theta}(z) = \lim_{\ell \rightarrow \infty} H_{j,n,-\ell}^{\omega^i,\theta}(z) = \frac{\int_X h_j(y) dm(y)}{\int_X h_n(y) dm(y)}.$$

But by the assumptions of this lemma, this number must coincide with $\frac{\int_X h_j(y) d\mu(y)}{\int_X h_n(y) d\mu(y)}$. Fix some $n \in \mathbb{N}$, then for each $j \in \mathbb{N}$ we have

$$(1) \quad \int_X h_j(y) dm(y) = C \int_X h_j(y) d\mu(y)$$

with

$$C = \frac{\int_X h_n(y) dm(y)}{\int_X h_n(y) d\mu(y)}.$$

Consider any interval $Y := \{k\} \times \hat{Y} \subset X$. We apply the triangle inequality.

$$(2) \quad |m(Y) - C\mu(Y)| < \\ |m(Y) - \int_X h_j(y) dm(y)| + \\ \left| \int_X h_j(y) dm(y) - C \int_X h_j(y) d\mu(y) \right| + \\ \left| C \int_X h_j(y) d\mu(y) - C\mu(Y) \right|.$$

By the assumption of the density of the functions $\{h_j\}$ we can find a subsequence $\{h_{j_k}\}$ so that $\lim_{k \rightarrow \infty} h_{j_k}(x) = 1$ if $x \in \text{int}(Y)$ and 0 if x is not in the closure of Y . Thus since m, μ are Radon measures, for each $\varepsilon > 0$ we can choose j_0 such that

$$\max \left(\left| m(Y) - \int_X h_{j_0}(y) dm(y) \right|, \left| C\mu(Y) - \int_X h_{j_0}(y) d\mu(y) \right| \right) < \varepsilon.$$

Combining this with Equations (1) and (2) yields $|m(Y) - C\mu(Y)| < 2\varepsilon$. Since $\varepsilon > 0$ is arbitrary we conclude that $m = C\mu$. \square

Notice that in the above lemma, the only rigidity we proved is with respect to conservative ergodic measures. But, the only $T^{\omega,\theta}$ -invariant ergodic measure on X which are not conservative, are measures supported on a single, bi-infinite non-periodic orbit of $T^{\omega,\theta}$. Such a measure is not a Radon measure if the bi-infinite orbit is dense because every neighborhood is visited an infinite number of times. Thus combining Lemma 6 and Proposition 2 yields

Corollary 7. *If the assumptions of Lemma 6 are verified, then up to scaling, the length measure μ is the unique $T^{\omega,\theta}$ -invariant, ergodic Radon measure.*

Thus for our proof we need to construct the set \mathcal{H} and show that for every $\omega \in \mathcal{G}$ the convergence suppositions of the Lemma hold for $\theta \in \mathcal{H}$, and all $(j, n) \in \mathbb{N}^2$.

Let $J_i \in \mathbb{N}$ be the maximal $J \in \mathbb{N}$ such that for all $1 \leq j \leq J$ the support of h_j is contained in X^{N_i} , i.e., inside the the ring of S_{ω^i} . Let $\mathcal{J}_i := \{1, \dots, J_i\}^2$. Notice that $J_{i+1} \geq J_i$ and that $\lim_{i \rightarrow \infty} J_i = \infty$.

For each i let A_i be the set of directions for which the map $T^{\omega^i, \theta}$ is uniquely ergodic when restricted to X^{N_i} . By [KeMaSm] the set A_i is of full measure. We additionally assume that A_i does not contain a saddle connection direction, this removes an at most countable set from the set of uniquely ergodic directions. Let $\gamma_i > 0$ be a sequence tending to 0 and fix i . We apply the Corollary 12 of the appendix on the uniform convergence of Hopf averages to any ω^i , $\theta \in A_i$, $(j, n) \in \mathcal{J}_i$ to conclude that there is an $\hat{\ell}$ which depends on i, θ, j, n such that

$$(3) \quad \left| H_{j,n,\ell}^{\omega^i, \theta}(z) - \frac{\int_X h_j(y) d\mu(y)}{\int_X h_n(y) d\mu(y)} \right| < \gamma_i$$

for all $\ell \geq \hat{\ell}$ and all $z \in X^{N_i}$ (except those z whose orbit hits a singular point before time ℓ). Choose $\hat{\ell}$ sufficiently large so that (3) holds for all $(j, n) \in \mathcal{J}_i$; note that $\hat{\ell}$ depends only on $\theta \in A_i$ and i .

Next we uniformize this estimate to a large set of directions. We choose $\ell_i \geq N_i$ and sets $B_i \subset A_i \subset \mathbb{S}^1$ so that $\lambda(B_i^c) < \gamma_i$ and $\hat{\ell}(i, \theta) \leq \ell_i$ for all $\theta \in B_i$. Consider the finite set of saddle connections of length at most $2\ell_i$, and a small open neighborhood of this set. By choosing the open set very small and modifying B_i we can additionally assume that it does not intersect this neighborhood

Now we would like to extend these estimates to the neighborhood $\mathcal{U}_{\delta_i}(\omega^i)$ for a sufficiently small strictly positive δ_i . We will impose various conditions on δ_i in an incremental way. The first requirement is

$$\mathbf{A0} \quad \delta_i < \min\{\omega_j^i : -n_i < j < n_i\}.$$

This requirement ensures that for all $\omega \in \mathcal{U}_{\delta_i}(\omega^i)$ we have $\omega_j > 0$ for all $-n_i < j < n_i$ which will ensure that the tables in the dense G_δ set G are connected.

We will explicitly state the next three requirements, **A1** - **A3** for forward orbits, the analogous requirements are also assumed for backward orbits, but will not be stated explicitly. Our goal is now to define a small neighborhood C_i of B_i , and then a large open subset D_i of C_i , and for each $\theta \in D_i$ to define a map $\zeta^+ = \zeta^+(\omega^i, \omega, \theta)$ defined on a large subset of X^{N_i} (for ω) onto X^{N_i} (for ω^i) which is close to the identity, and a map ζ^- satisfying similar conditions. The $+$ maps will control the future behavior of orbits, the $-$ map will control the past. In one of our first articles on the Ehrenfest model where we studied ergodicity [MSTr2] it was sufficient to use the identity map for the maps ζ^\pm . In our article on infinite ergodic index [MSTr3] we we have defined a

related map, but the form of the map considered in that article is not adapted to the study of unique ergodicity.

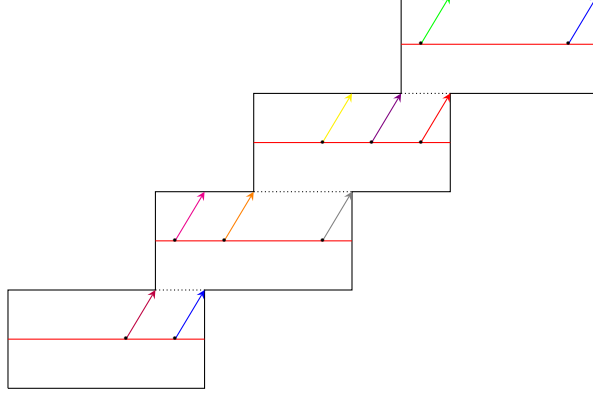

FIGURE 4. The set $\Sigma^{\omega^i, \theta, N_i}$.

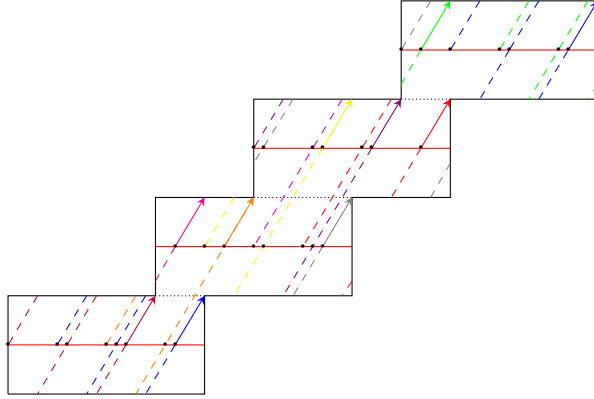

FIGURE 5. Partition of X^{N_i} into sets of continuity of $(T^{\omega^i, \theta})^{\ell_i}$.

To define ζ^+ for a direction $\theta \in B_i$ which has no saddle connection shorter than $2\ell_i$, we develop the argumentation when $\theta \in \mathbb{S}^1$ is in the interior of the first quadrant, and leave to the reader to derive the corresponding formulas for θ in the other quadrants. Consider the finite collection of points

$$\Sigma^{\omega^i, \theta, N_i} := \{(k, j - 1/2 \tan(\theta)) : j \in \{\omega_{k-1}^i, 2 - \omega_k^i, 2\}\} \cap X^{N_i}$$

(see Figure 4). $\Sigma^{\omega^i, \theta, N_i}$ consists of the points inside the ring for which the trajectory hits a singularity before hitting the next cross-section.

All the points in $\Sigma^{\omega^i, \theta, N_i}$ are distinct except for the pair of points $\{N_i\} \times \{2 - 1/2 \tan(\theta)\}$ and $\{N_i\} \times \{2 - \omega_{N_i}^i - 1/2 \tan(\theta)\}$ which are the same point since $\omega_{N_i}^i = 0$, as well as the pair of points $\{-N_i + 1\} \times \{2 - 1/2 \tan(\theta)\}$ and $\{-N_i + 1\} \times \{2 - \omega_{-N_i}^i - 1/2 \tan(\theta)\}$ which are the same point since $\omega_{-N_i}^i = 0$. We call such a point z a *blocking point*. Here, and at the discussion below, it's worth to recall that for

each integer k , $\{k\} \times [0, 2)$ is a circle and we will always consider the coordinates of the circle modulo 2.

Consider the collection of points

$$\hat{\Sigma}^{\omega^i, \theta, N_i} := \{(T^{\omega^i, \theta})^{-j} z : j \in \{0, 1, \dots, \ell_i\} \text{ and } z \in \Sigma^{\omega^i, \theta, N_i}\}.$$

Any point in this set corresponds to a unique $j \in \{0, \dots, \ell_i\}$ and a unique $z \in \Sigma^{\omega^i, \theta, N_i}$. This set partitions X^{N_i} into a finite number of intervals, $\{I_j^{\omega^i, \theta}\}$, such that on each of these intervals the forward map $(T^{\omega^i, \theta})^{\ell_i}$ is continuous (see Figure 5). This partition can be defined more generally than for $\theta \in B_i$, it makes sense as soon as there are no saddle connections of length at most $2\ell_i$. Thus for $\theta \in B_i$ and a small enough neighborhood $U(\theta)$, each interval $I_j^{\omega^i, \theta'}$ varies continuously with respect to $\theta' \in U(\theta)$.

Let $\eta_i(\theta) > 0$ be the minimum of the lengths of the intervals $I_j^{\omega^i, \theta'}$. Let

$$C_i := \bigcup_{\theta \in B_i} U(\theta).$$

We naturally extend the definition of the function $\eta_i(\cdot)$, originally defined on B_i , to the larger set C_i , it is a continuous function of θ . We additionally suppose that $U(\theta)$ is sufficiently small so that $\eta(\theta') > \eta_i(\theta)/2$ for all $\theta' \in U(\theta)$. By construction C_i is an open set containing B_i , thus $\lambda(C_i^c) < \gamma_i$. Furthermore, starting with (3), by continuity in θ we can suppose that for all $\theta \in C_i$ we have

$$(4) \quad \left| H_{j, n, \ell}^{\omega^i, \theta}(z) - \frac{\int_X h_j(y) d\mu(y)}{\int_X h_n(y) d\mu(y)} \right| < 2\gamma_i.$$

for all $\ell \geq \hat{\ell}$ and all $z \in X^{N_i}$ (except those z whose orbit hits a singular point before time ℓ).

We can do the same for backward orbits, we will choose ℓ_i to work for forward and backward orbits. We will denote by C_i the open set of directions satisfying both the forward and backward conditions.

For $\eta_i > 0$ consider the open set

$$D_i := \{\theta \in C_i : \eta_i(\theta) > \eta_i\}.$$

Since the function $\eta_i(\theta)$ is strictly positive for every $\theta \in C_i$, we can choose a small positive number η_i such that the set $\eta_i > 0$ such that the Lebesgue measure of the set D_i is at least $1 - \gamma_i$. So for all $\theta \in D_i$ the lengths of all the intervals $\{I_j^{\omega^i, \theta}\}$ are at least $\eta_i > 0$.

Now we consider a configuration ω , not necessarily ringed, but close to a ringed configuration. Assume now that $\theta \in D_i$ and note that the point $(T^{\omega, \theta})^{-j} z$ varies continuously with respect to ω close to ω^i , for any z which is not a blocking point for ω^i .

If w is very close to w_i such that $\omega_{\pm N_i} \neq 0$, then each of the two blocking points, $\{N_i\} \times \{2 - 1/2 \tan(\theta)\}$ and $\{-N_i + 1\} \times \{2 - 1/2 \tan(\theta)\}$,

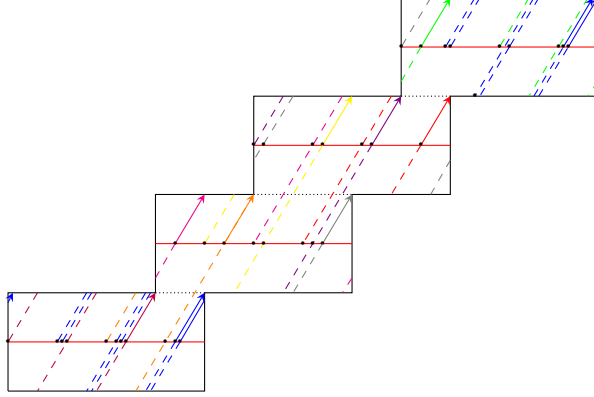

FIGURE 6. The partition changes continuously, the blocking points bifurcate.

bifurcates into a pair of points for S_ω . The bifurcated points create two new intervals $\tilde{I}_+^{\omega,\theta} = \{N_i\} \times (2 - \omega_{N_i} - 1/2 \tan(\theta), 2 - 1/2 \tan(\theta))$ and $\tilde{I}_-^{\omega,\theta} = \{-N_i + 1\} \times (2 - 1/2 \tan(\theta), 2 + \omega_{-N_i} - 1/2 \tan(\theta))$ in the partition induced by the set $\Sigma^{w,\theta}$ (see Figure 6).

Then, if we consider the partition $\{I_j^{w,\theta}\}$ defined in a similar way as the partition $\{I_j^{\omega^i,\theta}\}$, we have at most $2(\ell_i + 1)$ new intervals $\{(T^{w,\theta})^{-j} \tilde{I}_\pm^{\omega,\theta} : j \in \{0, \dots, \ell_i\}\}$. We call this collection of new intervals $\mathcal{I}^{w,\theta,N_i,*}$.

Let $V^{\omega,\theta,N_i} := \cup_{I \in \mathcal{I}^{w,\theta,N_i,*}} I$ be the union of all the intervals in the collection $\{I_j^{w,\theta}\}$. Since $\{I_j^{\omega^i,\theta}\}$ is in bijection with a subset of $\{I_j^{w,\theta}\}$ (except for at most $2(\ell_i + 1)$ new intervals) we can define an injective, piecewise affine transformation $\zeta^+ = \zeta^{+,\omega^i,\omega,n,\theta}$ from V^{ω^i,θ,N_i} to V^{ω,θ,N_i} that sends every $I_j^{\omega^i,\theta}$ affinely to the corresponding $I_j^{w,\theta}$. Note that, for ω sufficiently close to ω^i , this piecewise affine transformation is close to the identity.

It is important to underline that the definition of the map ζ^+ guarantees that the points $z \in X \setminus V^{\omega,\theta,N_i}$ for which the $T^{\omega^i,\theta}$ forward orbit of $\zeta^+(z)$ hits a singular point before time ℓ_i are points for which the $T^{\omega,\theta}$ forward orbit of z hits a singular point before time ℓ_i . Furthermore note that $X^{N_i} \setminus V^{\omega,\theta,N_i}$ is the set of points where ζ^+ is not defined. It consists of those points whose $T^{\omega,\theta}$ forward orbit segment of length ℓ_i exits the ring. In Figure 6 these are the points in between the close blue orbit segments which have bifurcated from a blocking orbit segment. These forward orbit segments have no usable relation to $T^{\omega^i,\theta}$ forward orbit segments of length ℓ_i .

Fix $\theta \in \overline{D_i}$ and suppose that ω is close enough to ω^i so that the above bijection is defined. Then we can define $\eta_i(\omega, \theta)$ to be the infimum length of all the intervals $I_j^{w,\theta}$. For ω sufficiently close to ω^i , for each $\theta \in C_i$, the function $\eta_i(\omega, \theta)$ varies continuously with ω since the set $\overline{C_i}$ does not contain any saddle connection directions of length at most

$2\ell_i$. Let $\eta_i(\omega) := \inf_{\theta \in \overline{D_i}} \eta_i(\omega, \theta) \geq 0$. We have that $\eta_i(\omega^i) = \eta_i(\omega^i, \theta_0)$ for some $\theta_0 \in \overline{D_i}$ and thus $\eta_i(\omega)$ is locally a continuous function of ω .

By the definition of D_i we have $\eta_i(\omega^i) \geq \eta_i$, we require that

A1 δ_i is so small that $\eta_i(\omega)$ varies continuously with $\omega \in \mathcal{U}_{\delta_i}(\omega^i)$ and $\eta_i(\omega) > \eta_i/2$ for each $\omega \in \mathcal{U}_{\delta_i}(\omega^i)$.

We make the analogous assumption for the ordered sets arising from backward orbits.

We require a further closeness condition on those orbits which we can control.

A2 We assume that $\delta_i > 0$ is so small that for all $\omega \in \mathcal{U}_{\delta_i}(\omega^i)$, for all $z \in X^{N_i}$ for which ζ^+ is defined, for all $\theta \in D_i$, we have

$$|H_{j,n,\ell_i}^{\omega,\theta}(z) - H_{j,n,\ell_i}^{\omega^i,\theta}(\zeta^+(z))| < \gamma_i.$$

Again we make the analogous assumption for ζ^- .

In the proof we will only consider directions in $\overline{D_i}$, the complement are directions where we are not able to control the Hopf averages. As already mentioned, we also are not able to control the Hopf averages of the forward orbits of points in $X^{N_i} \setminus V^{\omega,\theta,N_i}$. Our main goal is to control the backwards Hopf averages of such orbits.

A key point of the proof is that if $\theta \in D_i$, then for each $z \in X^{N_i}$ at least one of $\zeta^+(z)$ or $\zeta^-(z)$ is defined. To do this consider any $\theta \in D_i$ and the finite set $\hat{\Sigma}^+ := \hat{\Sigma}^{\omega^i,\theta,N_i}$ and the analogous set $\hat{\Sigma}^-$. These two sets do not intersect, for if they did there would be a saddle connection of length at most $2\ell_i$. Let $\nu_i(\theta) > 0$ be the minimum of the distances between pairs of points in these two collections and $\nu_i := \inf_{\theta \in \overline{D_i}} \nu_i(\theta)$. Since C_i avoids a neighborhood of the directions of the saddle connections of length at most $2\ell_i$ we have $\nu_i > 0$.

We define $\nu_i(\omega)$ in an analogous way.

A3 We assume that $\delta_i > 0$ is so small that for each $\omega \in \mathcal{U}_{\delta_i}(\omega^i)$ $\nu_i(\omega) > \nu_i/2$.

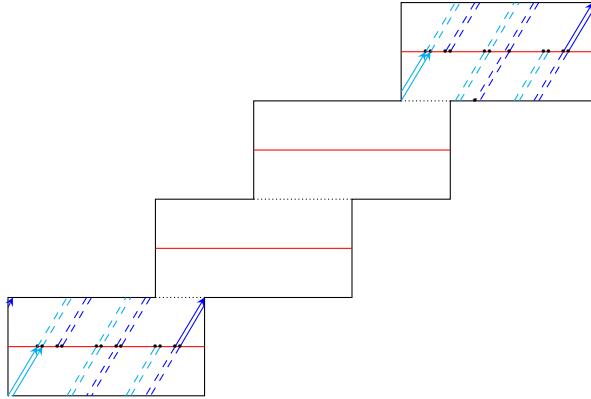

FIGURE 7. Uncontrolled forward orbits do not intersect uncontrolled backward orbits.

Fix i , by the triangle inequality, for any $z \in X^{N_i}$ such that $\theta \in D_i$ and $\zeta^+(z)$ is defined, we have

$$\left| H_{j,n,\ell_i}^{\omega,\theta}(z) - \frac{\int_X h_j(y,\psi') d\mu}{\int_X h_n(y,\psi') d\mu} \right| \leq \left| H_{n,\ell_i}^{\omega,\theta} h_j(z) - H_{n,\ell_i}^{\omega^i,\theta} h_j(\zeta^+(z)) \right| + \left| H_{n,\ell_i}^{\omega^i,\theta} h_j(\zeta^+(z)) - \frac{\int_X h_j(y,\theta) d\mu}{\int_X h_n(y,\theta) d\mu} \right|.$$

By **A2**, the first term is smaller than γ_i . Now we consider the second term.

By assumption $\theta \in D_i$ and thus if the orbit of $\zeta^+(z)$ does not hits a singular point before time ℓ , then (4) implies

$$\left| H_{n,\ell_i}^{\omega^i,\theta} h_j(\zeta^+(z)) - \frac{\int_X h_j(y,\theta) d\mu}{\int_X h_n(y,\theta) d\mu} \right| < 2\gamma_i$$

for all $1 \leq j \leq i$, and $1 \leq n \leq N_i$. Combining with **A2** we conclude

$$\left| H_{n,\ell_i}^{\omega,\theta} h_j(z) - \frac{\int_X h_j(y,\psi') d\mu}{\int_X h_n(y,\psi') d\mu} \right| < 3\gamma_i$$

for all z where ζ^+ is defined, with $\theta \in D_i$, for all $(j,n) \in \mathcal{J}_i$, for all $\omega \in \mathcal{U}_{\delta_i}(\omega^i)$ as long as the $T^{\omega^i,\theta}$ forward orbit of $\zeta^+(z)$ of length ℓ_i does not hit a singular point. As already pointed out we can thus consider points $z \in X^{N_i}$ such that ζ^+ is defined an the the $T^{\omega,\theta}$ forward orbit of z of length ℓ_i does not hit a singular point.

We make the analogous estimate on the past

$$\left| H_{n,-\ell_i}^{\omega,\theta} h_j(z) - \frac{\int_X h_j(y,\theta) d\mu}{\int_X h_n(y,\theta) d\mu} \right| < 3\gamma_i$$

for all z where ζ^- is defined, with $\theta \in D_i$, for all $(j,n) \in \mathcal{J}_i$, for all $g \in \mathcal{U}_{\delta_i}(\omega^i)$ as long as the backwards orbit of $\zeta^-(z)$ of length ℓ_i is defined.

Using **A3**, since $\lambda(D_i) > 1 - 2\gamma_i$, the set $\mathcal{H} = \bigcap_{M=1}^{\infty} \bigcup_{i=M}^{\infty} D_i$ has full measure. Fix $\omega \in \mathcal{G}$ and $\theta \in \mathcal{H}$, then there is an infinite sequence i_k such that $\omega \in \mathcal{U}_{\delta_{i_k}}(\omega^{i_k})$ and $\theta \in \Theta_{i_k}$ for all k . Since $J_{i_k} \rightarrow \infty$ we can conclude that for all $z \in X$ with $\theta \in \mathcal{H}$, for each $j \geq 1$, for each $n \geq 1$ either

$$(5) \quad \lim_{k \rightarrow \infty} H_{j,n,\ell_{i_k}}^{\omega,\theta}(z) = \frac{\int_X h_j(y,\theta) d\mu}{\int_X h_n(y,\theta) d\mu}.$$

or

$$(6) \quad \lim_{k \rightarrow \infty} H_{j,n,-\ell_{i_k}}^{\omega,\theta}(z) = \frac{\int_X h_j(y,\theta) d\mu}{\int_X h_n(y,\theta) d\mu}.$$

Lemma 6 finishes the proof of the theorem. \square

5. WIND-TREE PROOF

The proof of result in the wind-tree setting is essentially the same, there are three differences which we will point out. The first difference is the cross-section to the flow which we use. In the wind-tree setting we will use the first return map to the boundaries of the rhombi, and we will show that the structure of this cross-section is quite similar to the cross-section we used for staircases. The second difference is the description of ringed-configurations. The final difference is the description of the set corresponding to $\Sigma_{\omega^i, \theta, N_i}$ in Figure 4. In particular we have many more blocking points, and they can bifurcate in a slightly more complex way. Thus the domain of definition of the maps ζ^\pm are more complicated.

5.1. The phase space. If a rhombus does not intersect any other rhombus at each corner there are three directions pointing to the interior of the table, while for all other points there are only two such directions (see Figure 8). Intersecting rhombi can have slightly different behavior, but we do not need to describe it since they will only occur in the proof in a very special way.

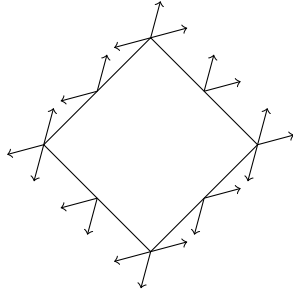

FIGURE 8. The phase space of one rhombus.

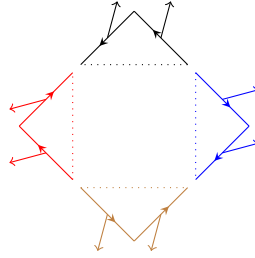

FIGURE 9. The phase space is the disjoint union of four closed oriented “intervals”.

By taking the arc length coordinate \mathfrak{s} along the diagonal of a rhombus, we think of the contribution of the rhombus with center z_n to $X^{g, \theta}$ as the union of four closed intervals I_ϕ^n indexed by $\phi \in [\theta] := \{\theta, \frac{3}{2}\pi - \theta, \pi + \theta, \frac{1}{2}\pi - \theta\}$, each of these intervals corresponds to the cartesian product of the two intersecting sides of the rhombus with a fixed inner pointing direction ϕ (see Figure 9) (as before the word inner means pointing into the table, so away from the rhombus). Since θ is assumed not parallel to a side, the set $[\theta]$ is in bijection with the set $\{1, 2, 3, 4\}$ by choosing the quadrant containing $\phi \in [\theta]$.

Note that for any n and ϕ the interval I_ϕ^n is just translated and rotated copy of the interval $I = [0, s]$. Using this we can drop the index n from the notation. This yields to the following identification.

$$(7) \quad X^\theta = \mathbb{N} \times I \times \{1, 2, 3, 4\}.$$

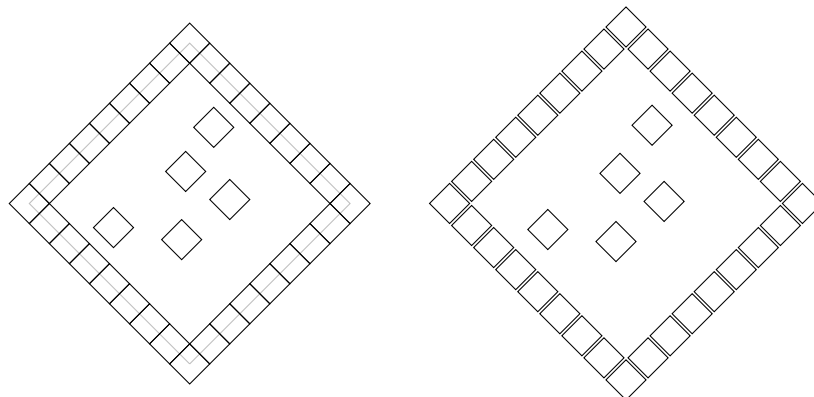

FIGURE 10. An 8-ringed configuration and a configuration close to it.

Let

$$\mathcal{U}_\varepsilon(g) := \{g' \in \text{Conf} : d_H(g', g) < \varepsilon\}.$$

Proposition 8. *There is a dense G_δ subset G of (Conf, d_H) such that for each $g \in G$*

- (1) g is an infinite configuration,
- (2) every pair of points $z_1, z_2 \in g$ satisfy $d(z_1, z_2) > s$.
- (3) there is an enumeration of g such that $d(z_n, 0)$ is a strictly increasing function.

Part (3) of the Proposition allows us to assert that the identification of the phase space with the set X^θ varies continuously with the parameter $g \in G$. The proof uses parameters which are not in G , however we will only use the identification with a compact part of X^θ which will vary continuously with the parameter.

Proof. Points (1) and (2) were proven in [MSTr3]. We start with a dense set of configurations $\{g_i\}$, such that each configuration is finite, and moreover $g_i = \{z_1^{g_i}, \dots, z_i^{g_i}\}$ satisfies condition (3). Let $\delta_i > 0$ be so small that $d(z_n^{g'}, 0)$ is strictly increasing for $n = 1, \dots, i$ for any $g' \in \mathcal{U}_{\delta_i}(g_i)$. Point (3) follows immediately for the dense G_δ set $\bigcap_{j=1}^\infty \bigcup_{i \geq j} \mathcal{U}_{\delta_i}(g_i)$. \square

5.2. Ringed configurations. A configuration h is n -ringed if the following three conditions hold:

- 1) the boundary $R(n) := \{(x, y) \in \mathbb{R}^2 : |x| + |y| = ns\}$ of the corresponding rhombus is completely covered by trees as in Figure 10 left (i.e., the obstacles covering the boundary intersect with each other on a whole side or do not intersect at all, and the boundary $R(n)$ intersection with each tree consists of two points which are in the middle of two sides of the tree),
- 2) the obstacles inside the ring, which we will call *interior obstacles*,

can be enumerated $\{z_1, \dots, z_m\}$ in a way such that their distance to the origin is a strictly increasing function,

3) no interior obstacle touches any other obstacle.

We start with a dense set of parameters $\{f_i\}$ such that each f_i is an N_i -ringed configuration, N_i is increasing with i , and f_i has at least i interior obstacles. We define $X^{\theta, N_i} := \{1, \dots, m\} \times I \times \{1, 2, 3, 4\}$ to be the part of the phase space corresponding to the inner obstacles; it plays the role of the set X^{N_i} in the staircase case.

5.3. The set corresponding to $\Sigma^{\omega^i, \theta, N_i}$ and the maps ζ^\pm . Consider the corners of the rhombi which are inside the convex hull of $R(n)$; this includes all the corners of inner rhombi and some corners of rhombi on the ring. Unlike for the staircase, the corners of inner obstacles are already on our cross-section, while for those points which are not in the set X^{θ, N_i} , we flow them backward until they hit the cross-section X^{θ, N_i} for the first time, these are the *blocking points*. This finite collection of points plays the role of the set $\Sigma^{\omega^i, \theta, N_i}$ for staircases. To define ζ^+ we proceed like for staircases, the backward $(T^{f_i, \theta})^{\ell_i}$ -orbits of these points partition X^{θ, N_i} into a finite number of intervals $\{I_j^{\omega^i, \theta}\}$, on each such interval the forward map $(T^{f_i, \theta})^{\ell_i}$ is continuous. The blocking points bifurcate into two or three points, depending on if two or three rhombi touch at the blocking point.

6. APPENDIX

6.1. Conservativity of $(T^{\omega, \theta}, X, \mu)$. Let $T = T^{\omega, \theta}$. An (*almost invariant*) *box sequence* is an increasing sequence (Y_n) of open subsets of X such that:

- (1) $X = \cup Y_n$
- (2) each Y_n is of finite measure
- (3) $\lim_{n \rightarrow \infty} \mu(T(Y_n) \setminus Y_n) = 0$.

Lemma 9 (Boxes lemma). *If there is an almost invariant box sequence then (T, X, μ) is conservative.*

Proof. Let (Y_n) be a box sequence for T . Let U be a non-empty open set. We want to show that U is *non-wandering*, i.e., that there is an i such that $T^i(U) \cap U \neq \emptyset$.

Let $V_n = U \cap Y_n$. By the definition of a box sequence, we have that $U = \cup V_n$. Thus, for some n_0 , V_{n_0} is non-empty. Let $V = V_{n_0}$ and $n \geq n_0$ large enough so $\mu(T(Y_n) \setminus Y_n) < \mu(V)$. Then we have $V \subset Y_n$.

For each $i \geq 1$, let A_i^n be the set of points in V who escape from Y_n at time i , namely

$$A_i^n = \{x \in V : T^i(x) \notin Y_n \text{ and } \forall 0 \leq k < i, T^k(x) \in Y_n\}.$$

Let us suppose the sets $T^i(A_i^n)$ are pairwise disjoint. Note that $\cup_i T^i(A_i^n) \subset T(Y_n) \setminus Y_n$, then we have

$$\begin{aligned} \mu \left(\bigcup_i A_i^n \right) &\leq \sum_i \mu(A_i^n) = \sum_i \mu(T^i(A_i^n)) \\ &= \mu \left(\bigcup_i T^i(A_i^n) \right) \leq \mu(T(Y_n) \setminus Y_n) < \mu(V). \end{aligned}$$

Thus the set $F = V \setminus \cup_i A_i^n$, which is the set of points in V whose (positive) iterates always stay in Y_n , is of positive measure. Given that Y_n is of finite measure, the Poincaré recurrence Theorem applied to $\cup_{i \geq 0} T^i(F)$ implies that this set F is non-wandering. Thus V and U are also non-wandering.

On the other hand if the sets $T^i(A_i^n)$ are not pairwise disjoint, then there exists $i \neq j$ such that $T^i(A_i^n) \cap T^j(A_j^n) \neq \emptyset$. Note that $A_i^n, A_j^n, T^i(A_i^n)$ and $T^j(A_j^n)$ have all non-empty interiors. Thus it follows that $T^{i-j}(A_i^n) \cap A_j^n \neq \emptyset$. But A_i^n and A_j^n are both subsets of V . Thus V (and also U) is non-wandering. \square

Proof. (Proposition 2) Consider a strictly increasing sequence i_n and a strictly decreasing sequence j_n such that $w_{i_k} \rightarrow 0$ and $w_{j_k} \rightarrow 0$. Then the sequence of sets $X_n := \{j_k + 1, \dots, i_k\} \times [0, 2)$ is a sequence of boxes for all θ . \square

6.2. Cantor representation. Consider the mapping $T : X \times \mathbb{S}^1 \rightarrow X \times \mathbb{S}^1$, induced by the first return map to the cross section X of the translation flow in the direction θ on a compacted connected translation surface. For each θ , the map $T|_{X \times \{\theta\}}$ is an interval exchange transformation (up to the behavior on the endpoints of the intervals). The following construction can be found in [GaKrTr]. Label the sets of continuity of T by a finite enumerated alphabet \mathcal{A} , these are connected regions, with piecewise smooth boundary (one can even choose coordinates so that they are polygonal regions [Ka]). Let X^∞ be the set of (x, θ) whose forward orbit does not hit a singularity (nor an endpoint of the cross section if the cross section does not start and end at a singular point), and for $(x, \theta) \in X^{(\infty)}$ let $i(x, \theta) \in \mathcal{A}^{\mathbb{N}}$ be the coding map defined by $i(x, \theta)_j = k \in \mathcal{A}$ if and only if $T^j(x, \theta)$ is in the k th element of \mathcal{A} . Let $K := \overline{i(X^{(\infty)})} \subset \mathcal{A}^{\mathbb{N}}$. Let \hat{T} denote the shift map on K , then by definition $\hat{T} \circ i = i \circ T$ on $X^{(\infty)}$. Each point $(x, \theta) \in X \times \mathbb{S}^1 \setminus X^\infty$ has exactly two images in K . The main result of [GaKrTr] it that the inverse $i^{-1} : K \rightarrow X \times \mathbb{S}^1$ satisfies that the set $i^{-1}(s)$ is in fact a single point except when s is a periodic point. If s is a periodic point then $i^{-1}(s)$ is a periodic cylinder in X .

Finally let $K^\theta := i^{-1}(X \times \{\theta\})$, this is the Cantor representation of the corresponding IET.

6.3. Uniform convergence of Hopf averages. Both in Sections 4 and 5, the first return maps we consider, $T^{\omega^i, \theta}|_{X^{N_i}}$ and $T^{f_i}|_{X^{\theta, N_i}}$, are IETs, thus they are not continuous. Therefore we need to discuss in detail the notion of unique ergodicity and its relation to uniform convergence of Hopf averages, as well as how the convergence varies as we vary the angle on the translation surface. To do this we will use the Cantor representation of the previous subsection.

Lemma 10. *An IET (T, X) without saddle connection is uniquely ergodic if and only if its Cantor representation (\hat{T}, K) is uniquely ergodic*

Proof. The only if direction is clear.

Consider any pair of \hat{T} invariant measures $\hat{\nu}_1, \hat{\nu}_2$. Using the mapping j we pushforward these two measures to a pair of measure ν_j on Y . Since T is uniquely ergodic the pushforwards satisfy $\nu_1 = \nu_2$. Thus for any measurable set $C \subset I$, setting $\hat{C} := j^{-1}(C)$ we have

$$(8) \quad \hat{\nu}_1(\hat{C}) = \hat{\nu}_2(\hat{C}).$$

If $\hat{\nu}_1 \neq \hat{\nu}_2$ then there is a measurable set $B \subset K$ such that $\hat{\nu}_1(B) \neq \hat{\nu}_2(B)$. Consider the sets $\hat{B} := j^{-1}(j(B)) \supset B$ and $B_1 := \hat{B} \setminus B$. By construction the set B_1 is at most countable since it is contained in the set consisting of the \hat{T} orbits of the finite set of j^{-1} preimages of the singular points of (T, X) . By Equation (8) we have $\nu_1(\hat{B}) = \nu_2(\hat{B})$, thus at least one of the two measures must give positive measure to the countable set B_1 , i.e., it must be atomic. Since we have supposed that there are no saddle connections, there can not be any atomic measures, thus $\hat{\nu}_1 = \hat{\nu}_2$. \square

We need the following result which we did not find in the literature, it is well known if $g \equiv 1$, i.e., for Birkhoff averages.

Proposition 11. *If $\hat{T}: K \rightarrow K$ is uniquely ergodic (in the finite measure sense) then for every $f, g \in C(K)$ (with $\int_K g d\mu \neq 0$)*

$$\frac{\sum_{k=0}^{\ell} f(\hat{T}^k(z))}{\sum_{k=0}^{\ell} g(\hat{T}^k(z))}$$

converges uniformly to a constant.

The proof is essentially identical to the proof in the Birkhoff case. **Proof.** From the Hopf ergodic theorem the constant must be equal to $\int_K f d\mu / \int_K g d\mu$ where μ is the unique invariant probability measure. From the uniform convergence of Birkhoff sums we can find an $L_0 > 0$ such that for all $\ell \geq L_0$ and all $z \in K$ we have $\sum_{k=0}^{\ell} g(\hat{T}^k(z)) > 0$ and thus the Hopf sums are well defined. Suppose that the convergence is

not uniform for some f, g . Then there exists $\varepsilon > 0$ such that for all $L \geq L_0$ there exists $\ell > L$ and there exists $z_\ell \in K$ with

$$\left| \frac{\sum_{k=0}^{\ell} f(\hat{T}^k(z_\ell))}{\sum_{k=0}^{\ell} g(\hat{T}^k(z_\ell))} - \frac{\int_K f d\mu}{\int_K g d\mu} \right| \geq \varepsilon.$$

Set $\mu_\ell := \frac{1}{\ell} \sum_{i=0}^{\ell-1} \delta_{\hat{T}^i z_\ell}$, then

$$\frac{\sum_{k=0}^{\ell} f(\hat{T}^k(z_\ell))}{\sum_{k=0}^{\ell} g(\hat{T}^k(z_\ell))} = \frac{\int_K f d\mu_\ell}{\int_K g d\mu_\ell}$$

and thus

$$\left| \frac{\int_K f d\mu_\ell}{\int_K g d\mu_\ell} - \frac{\int_K f d\mu}{\int_K g d\mu} \right| \geq \varepsilon.$$

Choose a convergent subsequence $\mu_{\ell_k} \rightarrow \mu_\infty$, then μ_∞ is an invariant probability measure and

$$\left| \frac{\int_K f d\mu_\infty}{\int_K g d\mu_\infty} - \frac{\int_K f d\mu}{\int_K g d\mu} \right| \geq \varepsilon.$$

Thus $\mu_\infty \neq \mu$. □

Remark: Given a continuous function $h : X \times \mathbb{S}^1 \rightarrow \mathbb{R}$ we define $\hat{h} : K \rightarrow \mathbb{R}$ by setting $\hat{h}(z) := h(j(z))$. The function \hat{h} is continuous since h and j are continuous, we will call it the *lift* of h .

Corollary 12. *Suppose $T : X \rightarrow X$ is a uniquely ergodic IET. Then for every $f, g \in C(X)$ (with $\int_X g d\mu \neq 0$)*

$$\frac{\sum_{k=0}^{\ell} f(T^k(z))}{\sum_{k=0}^{\ell} g(T^k(z))}$$

converges uniformly to a constant.

Proof. We consider the Cantor representation (\hat{T}, K) of (T, X) . By Lemma 10 it is uniquely ergodic. We lift f, g to \hat{f}, \hat{g} and apply Proposition 11 to \hat{f} and \hat{g} . Projecting back to X yields the uniform convergence of the Hopf averages of f and g . □

REFERENCES

- [AaNiSaSo] J. Aaronson, H. Nakada, O. Sarig, R. Solomyak, *Invariant measures and asymptotics for some skew products* Israel J. Math. 128 (2002) 93–134.
- [Ar] P. Arnoux, *Ergodicité générique des billards polygonaux (d'après Kerckhoff, Masur, Smillie)*. Séminaire Bourbaki, Vol. 1987/88. Astérisque No. 161–162 (1988), Exp. No. 696, 5, 203–221 (1989).
- [EhEh] P. and T. Ehrenfest *Begriffliche Grundlagen der statistischen Auffassung in der Mechanik* Encykl. d. Math. Wissensch. IV 2 II, Heft 6, 90 S (1912) (in German, translated in:) *The conceptual foundations of the statistical approach in mechanics*, (trans. Moravcsik, M. J.), 10-13 Cornell University Press, Itacha NY (1959).

- [FrHu] K. Frączek and P. Hubert *Recurrence and non-ergodicity in generalized wind-tree models* Math. Nachrichten 291 (2018) 1686–711.
- [FrUl] K. Frączek and C. Ulcigrai *Non-ergodic \mathbb{Z} -periodic billiards and infinite translation surfaces* Invent. Math. 197 (2014) 241–298.
- [FrUl1] K. Frączek and C. Ulcigrai *Ergodic directions for billiards in a strip with periodically located obstacles* Communications in Mathematical Physics 327 (2014) 643–663.
- [GaKrTr] G. Galperin, T. Krüger and S. Troubetzkoy *Local instability of orbits in polygonal and polyhedral billiards* Comm. Math. Phys. 169 (1995), no. 3, 463–473.
- [GoLa] S. Gouëzel and E. Laneeau *Un théorème de Kerckhoff, Masur et Smillie: unique ergodicité sur les surfaces plates* (French) École de Théorie Ergodique, 113–145, Sémin. Congr., 20, Soc. Math. France, Paris, 2010.
- [HoHuWe] P. Hooper, P. Hubert and B. Weiss *Dynamics on the infinite staircase* Discrete Cont. Dyn. Sys. 33 (2013) 4341–4347.
- [Ho] P. Hooper, *The invariant measures of some infinite interval exchange maps* Geom. Topol. 19 (2015) 1895–2038.
- [HuLeTr] P. Hubert, Pascal, S. Lelièvre and S. Troubetzkoy *The Ehrenfest wind-tree model: periodic directions, recurrence, diffusion* J. Reine Angew. Math. 656 (2011) 223–244.
- [HuWe] P. Hubert, and B. Weiss *Ergodicity for infinite periodic translation surfaces* Composito Math. 149 (2013) 1364–1380.
- [Ka] A. Katok *The growth rate for the number of singular and periodic orbits for a polygonal billiard* Comm. Math. Phys. 111 (1987), no. 1, 151–160.
- [KeMaSm] S. Kerckhoff, H. Masur, and J. Smillie, *Ergodicity of billiard flows and quadratic differentials*, Annals of Math. (2) 124 (1986), no. 2, 293–311.
- [MS] A. M. Málaga Sabogal *Étude d’une famille de transformations préservant la mesure de $\mathbb{Z} \times T$* PhD dissertation, Paris-Sud 11 University, 2014
- [MSTr1] A. Málaga Sabogal and S. Troubetzkoy *Minimality of the Ehrenfest wind-tree model* Journal Modern Dynamics 10 (2016), 209–228.
- [MSTr2] A. Málaga Sabogal and S. Troubetzkoy *Ergodicity of the Ehrenfest wind-tree model* Comptes Rendus Mathématique 354 (2016) 1032–1036.
- [MSTr3] A. Málaga Sabogal and S. Troubetzkoy *Infinite ergodic index of the Ehrenfest wind-tree model* Comm. Math. Phys. 358 (2018) 995–1006.
- [MaTa] H. Masur and S. Tabachnikov, *Rational billiards and flat structures*, Handbook of dynamical systems, Vol. 1A, 1015–1089, North-Holland, Amsterdam, 2002.
- [Mo] T. Monteil *Introduction to the theorem of Kerckhoff, Masur and Smillie* Workshop Arbeitsgemeinschaft: Mathematical Billiards, Apr 2010, Franckfurt, Germany. pp.955-1015, 2010, Oberwolfach Report
- [RaRa] K. Rafi and A. Randecker www.youtube.com/watch?v=byEo9PpHE8Y
- [RaTr] D. Ralston and S. Troubetzkoy *Ergodic infinite group extensions of geodesic flows on translation surfaces* Journal Modern Dynamics 6 (2012) 477–497.
- [Sa] O. Sarig *Unique ergodicity for infinite measures* Proceedings of the International Congress of Mathematicians Hyderabad, India, 2010 1777-1803;
- [Sc] K. Schmidt *Unique ergodicity and related problems* pp. 188–198 in “Ergodic theory proceedings Oberwolfach” Lecture Notes in Mathematics 729, Springer Verlag, Berlin-New York 1979.
- [Tr] S. Troubetzkoy *Recurrence in generic staircases* Discrete and Continuous Dynamical Systems - Series A 32, 3 (2012) 1047-1053
- [Ve1] W. Veech *Moduli spaces of quadratic differentials* J. D’Analyse Math., 55, (1990) 117–171.

[Ve2] W. Veech *Teichmüller curves in moduli space. Eisenstein series and an application to triangular billiards*. Invent. Math., 97, (1989) 553–583.

INRIA, CRI DE PARIS

E-mail address: `alba.malaga@polytechnique.edu`

AIX MARSEILLE UNIV, CNRS, CENTRALE MARSEILLE, I2M, MARSEILLE,
FRANCE

Address: I2M, Luminy, Case 907, F-13288 Marseille CEDEX 9, France

E-mail address: `serge.tribetzkoy@univ-amu.fr`