



HAL
open science

Absorptive Resilience Phase Assessment Based on Criticality Performance indicators for Water Distribution Networks

David Ayala Cabrera, Olivier Piller, Manuel Herrera, Denis Gilbert, Jochen
Deuerlein

► **To cite this version:**

David Ayala Cabrera, Olivier Piller, Manuel Herrera, Denis Gilbert, Jochen Deuerlein. Absorptive Resilience Phase Assessment Based on Criticality Performance indicators for Water Distribution Networks. *Journal of Water Resources Planning and Management*, 2019, 149 (9), 04019037, 15 p. 10.1061/(ASCE)WR.1943-5452.0001097 . hal-02264092

HAL Id: hal-02264092

<https://hal.science/hal-02264092>

Submitted on 6 Aug 2019

HAL is a multi-disciplinary open access archive for the deposit and dissemination of scientific research documents, whether they are published or not. The documents may come from teaching and research institutions in France or abroad, or from public or private research centers.

L'archive ouverte pluridisciplinaire **HAL**, est destinée au dépôt et à la diffusion de documents scientifiques de niveau recherche, publiés ou non, émanant des établissements d'enseignement et de recherche français ou étrangers, des laboratoires publics ou privés.

Absorptive Resilience Phase Assessment Based on Criticality Performance Indicators for Water Distribution Networks

David Ayala-Cabrera¹, Olivier Piller², Manuel Herrera³, Denis Gilbert⁴, and Jochen Deuerlein⁵

¹Postdoctoral Research Fellow, Dept. of Water, Irstea, F-33612 Cestas, France. Doctor of Engineering, Ingeniousware GmbH, Jollystraße 11, 76137 Karlsruhe, Germany.

Email: david.ayala@irstea.fr

²Senior Research Scientist, Irstea, Dept. of Water, Bordeaux Regional Centre, UR ETBX, 50 Ave. de Verdun, Gazinet, F-33612 Cestas, France. Adjunct Senior Lecturer, School of Civil, Environmental, and Mining Eng., Univ. of Adelaide, Adelaide, SA 5005, Australia.

³Research Associate, Dept. of Engineering, University of Cambridge, 17 Charles Babbage Rd., CB3 0FS Cambridge, United Kingdom.

⁴Research Engineer, Irstea, Dept. of Water, Bordeaux Regional Centre, UR ETBX, 50 Ave. de Verdun, Gazinet, F-33612 Cestas, France.

⁵Senior Researcher, 3S Consult GmbH, D 76137 Karlsruhe, Germany. Adjunct Senior Lecturer, School of Civil, Environmental, and Mining Eng., Univ. of Adelaide, Adelaide, SA 5005, Australia.

ABSTRACT

Water distributions networks (WDNs) are exposed to multiple hazards leading the network to operate under a range of critical conditions. This paper explores the relationship between the impact of anomalous events (AEs) of WDNs and the consequent palliative actions (PAs) to be implemented in the network to minimize such impact. Both AEs and PAs are assessed through a network resilience criticality index adapted to WDNs. The results are compared to those obtained from normal operating conditions with respect to the satisfaction rate of nodal demands. The

24 proposal is evaluated by two case-studies. The first corresponds to a small synthetic network
25 and the second to a medium size utility network. After a pipe burst event analysis there are also
26 scrutinized two different isolation actions in each of the two WDNs. The results quantify system's
27 resilience and support water utility managers on further decision-making processes. This is done
28 through critical resilience indicators that show to provide information and support both for better
29 crisis preparedness (planning) and management (mitigation).

30 INTRODUCTION

31 Water distribution networks (WDNs) are key urban complex infrastructures. They provide an
32 essential resource for life, being considered as critical infrastructures that require protection to
33 adequately accomplish their service (?). In 2014, a pipe burst of one of Los Angeles' (California,
34 USA) main pipes left water losses over 5,600 l/s. In 2018 and by similar reason, roads were closed
35 to motorists and pedestrian in central London (UK) while more than 20,000 homes were affected
36 by water shortage. Also in 2018, big factories such as Jaguar, Land Rover, and Cadbury shut plants
37 so water firm can fix burst pipes originated by cold weather in the West Midlands (UK). These
38 examples show how ensuring WDN resilience and security is a big concern for water utilities.

39 Water network vulnerability to failures depends on several factors such as nature of the affected
40 consumers, assets location, and time of the event occurrence. A continuous water supply service
41 has better security than those having intermittent service (?). In this regard, several authors argue
42 in their research that the best manner to guarantee water quality is by maintaining a pressure head
43 above a target threshold and preserving the continuity of the supply through the network (?; ?;
44 ?). Assessing WDN node importance plays a key role for approaching vulnerability. It depends
45 on a number of factors: sensitive population, node location, and system performance. Regarding
46 pipes, first we should notice is that they might perform a very different role for the water supply
47 ranging from distribute water to other pipes to properly supply consumers (?). Thereby, it is clear
48 that some of the network pipes are more important than others from a hydraulic point of view.
49 Thus, recognizing the diverse and relative importance of its pipes it is an essential factor to evaluate
50 the overall hydraulic performance (?). Pipes importance is related to estimate the risk of network

51 isolation and the risk of deficient pressure head at the demand points. (?) argue that information
52 related to the pipe importance will be helpful for design, planning, control and WDN management.
53 Several studies (??) focus their attention on the evaluation of the network performance under pipe
54 failures. Authors prioritized in this way network links by studying how each link failure would
55 affect the post-anomalous event network performance (??; ??). Multiple failures of the components
56 is another issue with high relevance in resilience studies. Widely considered causes of multiple
57 failures in pipes are the location of the isolating valves (isolation of surrounding area of the affected
58 pipe) (?), natural disasters (?), severe failures due to human-made causes (?), sudden-onset disaster
59 that are followed by multiple related sub-disasters (cascading events) (?), and random multiple
60 failures (?). It is, then, necessary to ensure a satisfactory performance of the system by planing and
61 investment on the study of those components critical for a suitable water supply (?).

62 In a WDN context, the first definition of resilience was given by (?). In their work, some criteria
63 were proposed for describing the performance in terms of reliability, resilience and vulnerability.
64 Resilience refers to the strength of the network and its behavior under different anomalous events
65 (AEs) (??; ?). The ability of the system to resist stress scenarios, mitigate failures, and overcome
66 their consequences through a quick recovery is often referred to as the resilience of the system
67 (?). Thus, network managers require implement actions to support their decision-making process
68 towards more resilient systems (?). WDN resilience assessment focuses on either the mechanical
69 failure of components such as pipe or pump failure. It should also be considered any hydraulic
70 failure of the system due to degraded pipe capacities and/or to uncertain nodal demand flows (?).
71 Resilience criticality indicators (RCIs) seek to quantify the impact on consumers as consequence
72 of an anomaly that occurs within the WDN. The criticality of the pipes (and other WDN assets) is
73 measured through the impact on the disruption to supply (?). In essence, RCIs attempt to evaluate
74 the capability of the system under different abnormal operational conditions such as emergencies,
75 component failures, and hydraulic changes. RCIs quantify how resilient the system is and support
76 the decision on actions in order to reduce the occurrences and to minimize the possible consequences
77 of any AE.

78 This work proposes a tool for exploring the consequences of pipe failures with respect to the
79 hydraulic performance of a WDN. This methodology can be adapted to the kind of critical event
80 that occurs (mechanical or hydraulic failure) and to the type of operative actions taken on response
81 at such event (mitigation, adaptation, restoration). The method splits into five stages: a) Define
82 network model and consumer characteristics, b) run hydraulic computer models, c) assess system
83 performance state, d) quantify resilience through RCIs, and e) resilience visualization. The proposal
84 aims to be a reliable tool to quantify the system resilience, supporting the decision-making process
85 to eventually reduce the occurrence of failures and minimize their potential consequences.

86 The paper also characterizes how the network works under pipe burst scenarios. Several
87 positions for pipe burst occurrences are evaluated. This is approached by considering water
88 demand at peak and valley requirements. Afterwards, the impact on the network performance is
89 assessed through an RCI specifically tailored to WDNs and also compared to normal operating
90 conditions regarding the satisfaction rate of nodes. The system resilience is presented as maps of
91 component importance. These maps represent the average system impact as consequence of AE
92 in each pipe of the WDN. These maps provide an easy and quick identification of areas of high
93 importance components in the WDN. This is made through visualization of both the overall effects
94 of any disruption event and the extent of low resilience CIs areas. The resilience assessment is
95 complemented by the so-called palliative actions (PAs) in case of disruption events. PAs operates
96 single and multiple isolation of WDN areas. The isolation PAs are mitigation actions attempting
97 to minimize the potential negative effects related to an AE. It is possible, then, to determine how to
98 enhance the network performance facing an AE by to the implementation of these types of isolation
99 actions and comparing the most critical results after application of each PA (for a specific time).

100 **PROPOSED THEORETICAL FRAMEWORK**

101 There is a need to develop a generic framework associated to WDN resilience as this concept
102 remains unclear in literature. This is based on the three-stage resilience approaches proposed by
103 the Franco-German ResiWater Project (?). These three-stages are supported by the three-capacities
104 of the system (?): 1) absorptive capacity, 2) adaptive capacity, and 3) restorative capacity. The

105 first capacity refers to the ability of the system to absorb the impact of any system perturbation
106 and to minimize its consequences (without corrective action from water utility managers side).
107 The adaptive capacity is the ability of the system to temporarily adjust undesirable situations by
108 undergoing some changes if absorptive capacity has been exceeded. The restorative phase refers to
109 the capacity of the system to implement long-term solutions so that the system performance reaches
110 a stable or better level than the initial state (prior to adverse operative conditions) (?).

111 The resilience notion aims at developing tools to prepare water utilities for crisis scenarios; as
112 it is the case of ResiWater project (?). This improves the definition proposed by (?) by including the
113 criterion of preparedness. Resilience, and specifically WDN resilience, is often measured using
114 performance metrics. Fig. ??a shows an example of a performance-based resilience curve, also
115 called “functionality curve” or “resilience triangle” (see *e.g.* ?; ?). The horizontal axis represents
116 time and the vertical axis performance (criteria to assessing resilience) (?). This resilience curve
117 can be split into events and actions. The first division of the resilience curve is measured at the
118 event starting time (t_{event}) and goes until the water utility initiate appropriate (palliative) actions.
119 Thus, we have the time in which the anomalous event occurs; t_{event} (*e.g.* pipe burst). We also have
120 the detection time (t_{det}), and the starting time t_{pall} in which any PA is implemented by the water
121 utility. The times of the absorptive stage involved in the model (event(s) part of the resilience curve)
122 are shown in Fig. ??b ($t_{event} \rightarrow (+)t_{det} \rightarrow (+)t_{pall}$). According to the framework of the ResiWater
123 project, the first stage (absorptive phase) of the network’s resilience is measured since t_{event} occurs
124 and goes until t_{pall} (see Fig. ??b). It is also possible to quantify the internal vulnerability of the
125 system mirroring its absorptive capacity. The absorptive phase is followed by another two stages
126 (adaptive and restorative) (?). The times involved in the model (action(s) part of the resilience
127 curve) are: t_{stab} , the time when all emergency measures are in place for maintaining the system
128 performance; t_{end} , the time when the system performance reaches a stable level; t_{acc} or acceptable
129 time, the maximum stipulated time in which the network can be under failure. The main goal for
130 t_{acc} is to quantify the degree of severity that users suffer during the period in which the system is
131 on failure mode.

132 This paper focuses on characterizing a WDN working under a pipe burst scenario (without
133 corrective action from water utility) at a specific time. According to the previous definition,
134 the paper explores the most critical AE consequences at the absorptive phase of the network
135 performance. This is made by shifting pipe breaks location along each WDN pipe and also varying
136 the water demands. The paper also proposes to evaluate the isolation actions at the same demand
137 period explored for the AE (see Fig. ??a) in order to determine the WDN capacity enhancing its
138 performance and to explore the relative importance of pipes. To ranking pipes it is important to
139 investigate the system performance during and after t_{pall} . However, this paper exclusively explores
140 the functioning of the network at t_{pall} , due that this information allows to know the more real
141 requirements for the WDN at the most critical operating condition during the absorptive phase.
142 This also ease to compare the results with the starting of the adaptive phase. When the pressure
143 head drops under unfavorable values, water utilities increase the pumping pressure (if pumps are
144 available) in order to boost pressure across the system to maintain positive pressure heads and also
145 avoid further contamination. These adaptive actions are only implemented prior to any palliative
146 actions and aim to improve the ability of the system to keep working properly. In case of pressures
147 back to normal, these actions delimit the end of the absorptive phase (at t_{pall}). Fig. ?? presents the
148 flowchart for the proposed system for evaluating resilience. Each stage is explained in the following
149 sections.

150 **Brief Description of the AE Under Investigation and Isolation Actions**

151 The AE under study corresponds to the pipe burst tested at each pipe of the system. There are
152 evaluated three different burst along the pipe. These are: 1) at pipe's initial point (Pos0), 2) at pipe's
153 center (Pos50), and 3) at pipe's terminal point (Pos100). The proposed burst locations proposed
154 in this paper attempt to emulate those commonly used for hydraulic simulations in WDN (??; ??;
155 ?; ?). Our proposal takes into account the flow direction within the pipes determining the burst
156 locations (Pos0, Pos50, and Pos100). This corresponds to the flow orientation obtained through
157 the simulation of the network working under normal operating conditions.

158 There are considered two isolation actions: 1) the single isolation action (SIA) of the affected

159 pipe, and 2) the multiple isolation action (MIA) - isolation of the surrounding area of the affected
160 pipe.

- 161 • SIA corresponds to the pipe isolation by means of two valves placed at the pipe extremes.
162 This allows to close exclusively the affected pipe (?). ? proposed single pipe isolation as
163 reliability indicator but it has a lack of practicality since any operation to fix a broken pipe
164 involves the closure of a larger hydraulic segment. The $m - 1$ reliability importance of each
165 single pipe can be calculated by simulating the system without this link. The importance
166 is defined as the ratio of the actual delivery and the target demand (see Section ??). This
167 information aids to quantify the system resilience by means of RCIs and to make preventive
168 actions, such as twinning of the most critical pipes, establishing schemes and prioritizing
169 maintenance or rehabilitation actions, or possible removal of redundant pipes.
- 170 • MIA corresponds to the isolation of a surrounding to the affected broken pipe. MIA can
171 occur in the network due to the isolation valves' configuration, where the exact location
172 of the isolation valves is unknown (or it is necessary to close more than one pipe). MIA
173 shows its usefulness as palliative action. The isolation of even larger parts of the network
174 (combination of several hydraulic segments) may require MIA facing contamination events.
175 This is depending on the source and its estimated spreading through the network. In this
176 way, it is firstly stopped any further dissemination of the contaminant. This is followed by
177 flushing of the contaminated pipes (?; ?; ?; ?). This action is applied to renew the water
178 and extract the contaminant substance of the affected pipes and to additionally avoid the
179 contaminant spread (?).

180 **Topological Characteristics of the Network**

181 WDNs can be represented as a network/graph $\mathbf{G} = \mathbf{G}(\mathbf{V}, \mathbf{E})$ of nodes/vertices (*e.g.* reservoirs,
182 tanks, demand nodes), \mathbf{V} , connected by links/edges (*e.g.* pipes, valves), \mathbf{E} (?; ?). The topological
183 characteristics of the networks are generally represented by the incidence matrix \mathbf{A}^N , Eq. (??).

$$A_{(i,j)}^N = \begin{cases} -1 & \text{if node } i \text{ is terminal point of link } j \\ 0 & \text{if node } i \text{ is not connected to link } j \\ 1 & \text{if node } i \text{ is the initial point of link } j \end{cases}, \quad (1)$$

where $i = 1, \dots, n$ with i the node number and $j = 1, \dots, m$, with j the link number. For further hydraulic computations, matrix \mathbf{A}^N is generally partitioned into two sub-matrices, \mathbf{A}_f and \mathbf{A} ; that represent respectively nodes with fixed head (reservoirs or tanks) and nodes with unknown head (demand or junction nodes). This incidence matrix maybe used to accelerate the detection of the surrounding area to the affected pipe (Appendix ??).

Hydraulic Models

The steady-state of the entire WDN is simulated both through the potential at the nodes (head) and the link flows at a specific time (?). This is expressed by the Eq. (??). In this equation, \mathbf{q} represents the vector of flow in the links; \mathbf{h} and \mathbf{h}_f are the head at nodes with unknown head, and head at fixed head nodes, respectively; and \mathbf{d} represents the water demands at consumers (vector). The head losses in the links is described by $\Delta h(\mathbf{r}, \mathbf{q})$, where \mathbf{r} is the pipe friction coefficient.

$$\begin{cases} \mathbf{A}\mathbf{q} + \mathbf{d} = 0; & \text{mass balance at every node} \\ \Delta h(\mathbf{r}, \mathbf{q}) - \mathbf{A}^T\mathbf{h} - \mathbf{A}_f^T\mathbf{h}_f = 0; & \text{energy balance at every link} \end{cases}, \quad (2)$$

For hydraulic modeling of the network it is important to differentiate between the two demand driven model –DDM, and pressure driven model –PDM. Classical techniques for hydraulic analysis of WDNs (DDM formulations) are analyzed under the assumption that water demands are known and fully satisfied. This happens whether or not the available head pressure is enough to guarantee the delivered outflow. Hence, in the hydraulic simulations carry on through the uses of DDM approach, the delivered outflow (\mathbf{c}) at each node i , is equal to the required design ($c_i = d_i$) (?). If the pressure head drops below a certain threshold, as consequence of some AE, the outflow rate will be significantly reduced. In those cases, the hydraulic analysis performed through DDM approaches can deviate considerably from reality (?; ?).

206 For a PDM approach (suitable for systems operating under unfavorable conditions), the outflow
 207 is described by the so-called Pressure Outflow Relationship (POR). The demand is split into three
 208 levels of satisfaction: adequate or full, partial or degraded, and critical or zero outflow. Adequate
 209 or full outflow appears when the available pressure head is enough to fully satisfy the water
 210 requirements for all the consumers. This demand satisfaction level allows to continue operating
 211 under DDM. The usefulness of the proposed PDM approach comes in partial or degraded outflow
 212 scenarios in which the delivery conditions are given by the current system pressure. In extreme
 213 conditions, there is a zero outflow that corresponds to the case in which the system collapses in
 214 its operation (partially or in a full manner). In this case, the system does not guarantee delivery
 215 of any outflow to the user. POR is able to capture the behavior of the system when it is working
 216 under stress conditions. This in terms of showing the pipe flows reordered and so the supply of the
 217 outflow available. There are several proposals in the literature related to POR (??; ??; ??; ??; ??; ??; ?).
 218 The PDM approach follows Eq. (??).

$$219 \quad c(\mathbf{h}) = \mathbf{d} \times \begin{cases} 1 & \text{if } \mathbf{h}_s \leq \mathbf{h} \\ \left(\frac{\mathbf{h} - \mathbf{h}_m}{\mathbf{h}_s - \mathbf{h}_m} \right)^{0.5} & \text{if } \mathbf{h}_m < \mathbf{h} < \mathbf{h}_s \\ 0 & \text{if } \mathbf{h} \leq \mathbf{h}_m \end{cases}, \quad (3)$$

220 where \mathbf{h}_m corresponds to the minimum head. The value of \mathbf{h}_m is commonly fixed for a system
 221 and directly related to the nodal elevation. \mathbf{h}_s refers to the service head necessary to guarantee the
 222 consumers' water requirements. Some criterion for \mathbf{h}_s in order to consider the flow directions and
 223 the connected pipes' head losses is presented in ?).

224 The DDM and PDM system can be approached in various ways. For example, by means of
 225 a damped Newton method as it is proposed in ?). Another interesting proposal is presented in
 226 ?) considering sensitivities with respect to the demand. These local sensitivities provide relevant
 227 information on aspects such as sensor placement or confidence intervals for hydraulic performance
 228 predictions. Examples of other PDM formulations ?) use a Co-content Model Approach for the
 229 hydraulic analysis of WDNs under unfavorable operative conditions. The up-to-date snapshot of

230 the ongoing research in this area (software applications for PDM) can be found in (?; ?).

231 **Water pipe burst/leakage.** Pipe burst or leakage is a pressure dependent phenomenon and key
232 for WDN resilience assessment. This is a challenging issue as the available pressure at consumer
233 points might decrease with the pressure head reduction due to water leaking at the pipe burst point
234 (?). Pipe burst events cause inefficient energy distribution through the network (?; ?). In addition,
235 low pressure conditions within the system may lead to the introduction of pollutants into WDNs
236 and, consequently, worsen water quality (?). Therefore, a pipe break (via pipe burst) represents
237 not only decreasing revenues for water utilities (?), but also a deterioration in the water quality and
238 wasted energy resources. It should be properly distinguished between pipe burst and pipe leakage.
239 The first is a visible damage and it can start to be fixed immediately (if operational resources are
240 available from the water utility). Leakages usually are not visible and their detection requires
241 mathematical algorithms and sophisticated methods and/or equipment (?).

242 The treatment of the outflow as pressure head function for a specific junction node is in
243 general based on some form of the orifice equation (?). Thus, in WDNs both leaks and burst are
244 commonly modeled by the well-known Torricelli equation (?). Torricelli's equation represents,
245 under conditions of zero energy loss, the conversion of potential pressure energy to kinetic energy.
246 A discharge coefficient (C_d) is included in the Eq. (??) to consider energy losses by friction and
247 the orifice's effective area (?).

$$248 \quad c_L(\mathbf{h}) = \begin{cases} C_d A_L \sqrt{2g\Delta h} = C_d A_L \sqrt{2g\sqrt{h} - h_m} & \text{if } h_m \leq h \\ 0 & \text{otherwise} \end{cases}, \quad (4)$$

249 where c_L represents the water leaked; $C_d A_L$ is the leak effective area; A_L represents the orifice
250 area; and g is the gravity acceleration. For modeling purposes, the orifice equation is typically
251 simplified as an emitter form where multiple orifices might be combined into a single emitter (?).

252 **AN APPROACH TO RESILIENCE CRITICALITY INDICATORS**

253 In WDNs, there is an essential need to generate specific metrics that allow to quantify the
254 system performance when it is working under failure (or unfavorable) conditions. There are several

255 indicators aiming to capture this performance through mathematical formulations. We propose that
256 these indicators may be classified in the following six groups: 1) Power/Energy (?), 2) Performance
257 (such as the demand satisfaction indicators proposed herein), 3) Graph theory/Social Networks (?),
258 4) time (?), 5) sensitivities (?), and 6) others ?.

259 A widely used method to quantify the WDN resilience is through power/energy-based indicators.
260 This indicators class is, at the same time, divided into three groups: a) power-based indicators,
261 b) energy based indicators, and c) entropy-based indicators. The most popular power/energy-based
262 indicator is Todini's resilience index (?). This index is a power-based indicator that describes the
263 relationship between the power supplied to the end-user and the maximum power dissipated in
264 the network to satisfy the water requirements for the consumers. Several authors have proposed
265 other definitions based on the Todini's resilience index (?; ?; ?; ?; ?). These authors attempt to
266 obtain a better understanding of the network reliability through the uses of their indicators. ?)
267 and ?) included into the Todini's indicator the uniformity of pipe diameters and loop diameter,
268 respectively. ?) found an inconsistency in Todini's resilience indicator if it is used to measure
269 resilience when there are multiple sources for the WDN. Subsequently, they propose an indicator
270 attempting to fix this issue. Other modifications of Todini's resilience index aimed to enhance it
271 by including different pressure-dependent modeling cases. This is the case of the proposals of ?)
272 which focuses on leakage related issues and ?) which deals with leakage and consumption issues.

273 The Franco-German ResiWater Project (?) proposes the use of an event-driven approach that
274 can be classified as a performance indicator. In this project ?) exemplify the network resilience
275 due the occurrence of some critical event and consider aspects of the resilience such as: sequence
276 of events, type of approach used in the hydraulic model (DDM or PDM), the system performance
277 state, and the use of resilience power-based indicators.

278 The energy-based indicators address resilience assessment through the energy available at
279 the system. Some examples of these indicators are minimum and maximum head sources; the
280 minimum, mean, and maximum node pressure (?); the standard deviation of the node pressures
281 (?); the minimum and the sum of surplus head (?); and the energy dissipation (?), among others.

282 The entropy-based indicators propose an interesting point of view with respect to the network
283 resilience assessment. This is the case of the statistical flow entropy indicator proposed by (?) based
284 on the relative uniformity of the pipe flow rates (?). In (?) RCIs of the group of power-based and
285 entropy-based indicators are evaluated for WDN design. The authors evaluated the results of the
286 optimization under critical operating conditions: single isolation action and hydrant service. The
287 paper concludes that the group of power-based indicators represent a better estimation of resilience.
288 (?) proposed other definition of the resilience indicators, where there are considered aspects such
289 as time, water quality (before and after an AE), reserve capacity in tanks, and demand satisfaction.

290 Graph-theory based indicators represent an alternative for WDN resilience assessment (?;
291 ?). (?) and (?) proposed hybrid, hydraulic and graph-theory based, approaches for assessing
292 the WDN resilience. This was done by considering the pipeline's geodesic distances and head
293 losses associated with the water flow. In both papers, the criticality of pipes is measured through
294 the effective supply of users. These approaches were complemented by (?) by assessing WDNs
295 resilience through a topological perspective. There were also proposed to extend the graph-theory
296 based indicators into a multi-scale order in order to take into account the district metered areas
297 (sectors) configuration. (?) show that geometrical and topological features (using graph-theoretic
298 and fractal tools) provide useful knowledge for the WDN resilience assessment even in the case of
299 not having or partial hydraulic information. Also based on a topological metrics, (?) present a graph
300 decomposition model for WDNs. The developed model is used to facilitate WDN reliability analysis
301 (?). Another interesting example, mainly applied on power supply systems, is presented in (?), where
302 the authors proposed using graph theoretical measures for critical link analysis. This is done by a
303 computing reliability of links and an object-oriented based method for vulnerability analysis. It is
304 worth mentioning that the recognition of topological interdependence among critical infrastructure
305 systems (*e.g.* energy, water supply and wastewater, communications, transport systems) may avoid
306 serious consequences (?) due to the network working under the effects of anomalous events (?).

307 **Impact of a failure - Demand satisfaction RCI.** In a system failure scenario it is expected
308 to get a reduction on the volume of water supplied (?). Thus, a proper evaluation of the network

309 performance and determining how critical is the reduction in the supply becomes a challenge for
 310 water utilities. For a specific time, the satisfaction rate **SR** in a WDN (Eq. (??)) is the relationship
 311 between the water provided and the user's requirements (?; ?). In addition of being an RCI, **SR** is
 312 also an estimation of the reliability when it is computed for a given failure in j -th component (or
 313 set of components) with respect to its impact at i -th user (node).

$$314 \quad SR_{i,j} = \frac{c_{i,j}}{d_i} . \quad (5)$$

315 The impact (due to the network operating under unfavorable or critical conditions) is given by
 316 the average satisfaction rate (**ASR**) for the entire system. **ASR** describes the relationship between
 317 the total volume of water supply and the total volume of users demand, Eq. (??). Therefore,
 318 **ASR** is the response of the system in terms of the availability of water when it is operating under
 319 unfavorable conditions (due to the failure of the component j). In Eq. ??, n_d is the total number of
 320 demand nodes. **ASR** is ranging between 0 and 1; where 0 is the collapse situation and 1 is the case
 321 in which the whole system is totally resilient to the failure.

$$322 \quad ASR_j = \sum_{i=1}^{n_d} \frac{d_i}{\sum_{i=1}^{n_d} d_i} SR_{i,j} = \frac{\sum_{i=1}^{n_d} c_i}{\sum_{i=1}^{n_d} d_i} . \quad (6)$$

323 In general, overviewing risk assessment modeling for pipes uses break frequency and degra-
 324 dation rates as main aspects for assessing pipe deterioration. The analysis of the state of the
 325 entire network pipes requires a detailed information of their characteristics. However, this type of
 326 information is not often available in water utilities (?) and the risk quantification analysis is not
 327 contemplated herein.

328 CASE-STUDIES

329 This section implements further applications of the methodology for assessing WDN criticality
 330 proposed in Section ???. Two WDNs working under abnormal/degraded operating conditions, as

331 described above (Section ??), are used for their critical analysis. Firstly, a small size benchmark
332 network is investigated. The second case-study corresponds to a medium size utility network with
333 an average population density in France. The Hazen-Williams (H-W) and the Darcy-Weisbach
334 formulation are used to compute the head loss for the simple and complex case-study, respectively.

335 **Simple Case-Study**

336 The first case-study corresponds to a two loop network (TLN) proposed by ?). This is a simple
337 benchmark network composed by 6 demand nodes, 8 pipes and 1 reservoir (Fig. ??). The choice
338 of such a simple network is motivated by the necessity of facilitating the analysis of the results.
339 Several authors have used this network for WDN management research and resilience assessment
340 (?; ?; ?; ?). Table ?? details the TLN network features.

341 *Simple Case-Study – Impact at System and Nodes as Consequence of Burst Position*

342 This case-study investigates three different locations along one affected pipe and how are their
343 effects in the system performance. The results are presented in Fig. ?? and the hydraulic simulations
344 are computed by PDM. Fig. ??a presents the resilience assessment for the **ASR** indicator. The max-
345 imum, medium and minimum impact on the network are estimated by $maxImp_j = \min(ASR_{j,Pos})$,
346 $medImp_j = \text{mean}(ASR_{j,Pos})$ and $minImp_j = \max(ASR_{j,Pos})$. The network performance at the
347 system nodes for the three mentioned positions of the burst, in terms of pressure head and water
348 availability (**SR**), are presented in Fig. ??(b-d) and Fig. ??(e-g), respectively.

349 Fig. ??a shows that the maximum impact on the network under study occurs when the burst
350 is located at one of the ends of an affected pipe (Fig. ??a; curve $maxImp$). Pipe P3 presents an
351 exception as the minimum network impact is given by Pos50. At this point it is important to make
352 the proper selection of the leak point for each pipe. This is because the most critical behavior
353 of the network under this failure may significantly vary depending on the burst position along
354 the pipe. Estimating it wrongly can lead to do not take proper actions and consequently to bring
355 cost overruns for water utilities. Fig. ??a also shows a difference for the failure impact at each
356 pipe ($minImp_j - maxImp_j$). For pipe P1, the maximum difference in the system performance
357 deterioration is given for the pairwise (Pos0, Pos100). This difference is approximately 91%

358 in terms of water availability resilience. If a burst occurs in the pipe P1, at position Pos0, the
359 resilience for entire system is 97%. We can also observe that the leak outflows for pipe P1 at Pos0 is
360 2583.8 L/s, at Pos50 is 906.3 L/s, and at Pos100 is 650.7 L/s. The water head loss coming from T1
361 to the leak position in P1 is 0.1 m, 52.6 m and 56.2 m, respectively. It is worth mentioning that the
362 leakage outflow rate at Pos0 is very high (2583.8 L/s), comparing it to Pos50 and Pos100. However,
363 the available pressure head downstream the break point is the same than the associated with the
364 reservoir (following the model). Likewise, and due to the head loss for this case, the pressure
365 head available downstream of break point is similar to that obtained for the original state of the
366 network (without failure). This results on a minimal decrease in the system resilience comparing
367 it to the other two position tested. Thus, in future works it is worthwhile to study other indicators
368 of resilience in which the volume of leaked water is considered in the approach.

369 The maximum impact in the network due to an AE points out at the most critical allocation of
370 the burst along the affected pipes (Fig. ??a; curve *maxImp*) will be used in Section ?. This is of
371 main importance for assessing the network performance after the implementation of the proposed
372 PAs (MIA and SIA).

373 Fig. ??(b-d) shows a considerable decreasing in the state of the system performance as conse-
374 quence of the pipe burst. Even though some nodes are still working, we can say that the network's
375 performance state is, in general terms, under failure mode. This is strongly confirmed when the
376 pipe burst is placed at one end of the pipe (Pos0 or Pos100). In the absorptive phase of the system
377 resilience, the network performance state is considered in failure mode when the first consumer is
378 affected ($h \leq h_s$; in our case $h_s - \text{elevation} = 30$ mH₂O, green curve)

379 The node performance state is determined by two conditions; $h_m < h < h_s$ (with $h_m -$
380 $\text{elevation} = 0$ mH₂O in our case, red curve) and $h \leq h_m$; for the network working under degraded
381 and failure mode, respectively. Fig. ??(b-d) shows negative pressure values. An incorrect prediction
382 can occur in hydraulic simulations with PDM approach. This is since the mathematical model only
383 restricts delivered water if insufficient pressure values are obtained. Despite this approach will raise
384 the pressure, the PDM model still can yield negative pressure with zero water outflow (Fig. ??e-f)

385 as mentioned in ?).

386 *Simple Case-Study – Pipe Burst and Isolation of the Affected Pipe*

387 Fig. ??(a-b) shows the system resilience results for the three operative conditions considered
388 in this paper. The respective rankings of the hydraulic importance of the affected component (in
389 this case pipes) for the simple case-study are shown as well in this figure. Fig. ??(a-b) includes the
390 most critical AE (due to the burst location) for each affected pipe (see Fig. ??a), SIA, and MIA.

391 The set of adjacent pipes for MIA is obtained through Eq. (??). It should be necessary to
392 consider the implementation of subsequent actions by the water utilities (to be applied after PAs)
393 such as auxiliary pumping (?) at the adaptive resilience stage or the implementation of long-term
394 actions such as repair or to repair/replace (long term actions) at the adaptive or the restorative
395 resilience stage, respectively.

396 The values of the resilience previously obtained (Fig. ??a, *maxImp* curve) for the average
397 impact at system are ordered from major to minor impact on the resilience assessment. This
398 ordered curve is presented in Fig. ??(a-b; blue line). The performance results for the network
399 working under effects of the isolation PAs (SIA and MIA) are showed in Fig. ??(a-b); Fig. ??a with
400 red continuous line for SIA, and Fig. ??b with red dashed line for MIA. For SIA and MIA results,
401 the order obtained with the ranking of pipes for the network working under effects of the AE is
402 preserved. Fig. ??(c-e) shows the average impact at the system nodes generated for the network
403 working under effects of the three adverse operative conditions evaluated.

404 The comparison between the AE with each tested isolation PA (see Fig. ??) shows that:

- 405 • in both of the PAs evaluated (SIA and MIA), we can observe that the internal vulnerability
406 of pipes ($1 - \text{ASR}$) is higher for AE than PAs at t_{pall} (Fig. ??,a-b). This is valid for the
407 components that do not collapse the network by themselves.
- 408 • SIA shows better results (as isolation action) than MIA as it provides the maximum en-
409 hancement, 71%, for the network resilience. This is an outstanding result as the operative
410 condition when MIA shows a maximum enhancement for the network resilience of just

411 26%. However, as mentioned in Section ??, SIA for each pipe is not a realistic solution
412 (due to the potential cases of pollutants into the network, to the valves location, that is
413 non-profitable in economic terms, among others). In this sense, the set of pipes associated
414 with the pipes P4 to P8 are shown as an option that would not collapse the network, it just
415 in case that is necessary to isolate an specific area of the network. In the case of SIA, only
416 the isolation of the pipe P1 is capable to collapse the system's functioning.

- 417 • Fig. ??a shows a system resilience enhancement after the implementation of SIA. The
418 resilience increases in average up to 55% for all the pipes except for P1, the pipe associated
419 with the tank.
- 420 • Fig. ??(c-e) shows that the most critical impact on the simple case-study nodes (due to the
421 AE and PAs) occurs in the farthest nodes (N6 and N7) from the tank. Nonetheless, we can
422 observe that although the farthest node (N7) from the tank is not the node that suffers the
423 most impact in the three operative conditions evaluated and the most critical node is node
424 N6 (see Fig. ??d). This reveals that selecting a suitable level of detail (i.e. node elevation,
425 water demand, pipe length and diameter) for hydraulic models is a relevant issue to be
426 considered on the network resilience assessment.

427 **Complex Case-Study**

428 In this section we apply the proposed methodology for criticality assessment of WDNs through
429 a utility network case-study. This WDN (Fig. ??) has 1738 nodes, 1 tank, and 1781 pipes (116 Km),
430 43 loops, and 3 different pipe materials (cast-iron, PVC, PE). The total demand ranges from 5.7 L/s
431 to 21.3 L/s and the demand curve is defined at hourly basis for a week (Fig. ??b). The head of the
432 tank is considered as a reservoir for the related hydraulic simulations and its upstream network is
433 not taken into account further.

434 *Complex Case-Study – Impact at System and as Consequence of Burst Position*

435 A map of component importance represents the average system impact as consequence of the
436 AE in each pipe of the system. The resilience results presented as component importance maps

437 with respect to the maximum and minimum demand (see Fig. ??b) are approached in Fig. ?? by
438 showing the ASR indicator. The AE is tested at three different positions along each pipe. Thus,
439 three different maps are built (for each demand evaluated) depending on the AE's average impact
440 in the system. The AE is located at the middle of each pipe for better comparison between maps.

441 Fig. ?? encompasses four analysis areas aiding further results interpretation. As consequence of
442 the AE, Fig. ??(d-f) shows a notable decreasing on the network resilience for zone1, in comparison
443 with the estimated resilience for the maximum demand period (Fig. ??,a-c) for the same zone. This
444 effect is due to a pressure head increment as the demand nodes requirements decrease (minimum
445 peak of demand). However, this performance is not preserved in the *maxImp* maps (insets c
446 and f) for zone2. Fig. ?? also shows two critical zones (zone2 and zone3) for all the evaluated
447 characteristics (demand peaks and burst position). The area nearby the reservoir (zone4) shows a
448 not considerable affection with respect to the entire system resilience for the AE, also for all the
449 evaluated conditions. This performance is due to the redundant topology of pipes belonging to
450 zone4 (Fig. ??c). Only a small area in zone4 is sensible to the AE. Still, there is a small effect
451 generated in such zone by the AE in terms of the entire network performance.

452 Table ?? shows a maximum impact in resilience for the considered AE in the period of minimum
453 demand. The network performance is, then, consequence of an increasing pressure head due to
454 decreasing demand requirements. A greater impact for the AE of burst is shown in the periods
455 of low demand making them the most critical periods for this event. Overall, the results show a
456 variation between the minimum (44.68%) and maximum (99.39%) resilience for all the network
457 characteristics contemplated (maximum and minimum demand peak and position of burst in the
458 pipe). The most critical condition for the network occurs for a value order of 44.68% (Table ??) in
459 terms of the satisfied average demand.

460 *Complex Case-Study – Pipe Burst and Isolation of the Affected Pipe*

461 The component importance maps are shown in Fig. ?? for the two isolation PAs considered
462 herein. The zones proposed in Fig. ??, for the AE, are preserved in Fig. ?? to facilitate the
463 comparison between AE and PAs.

464 In Fig. ?? we can observe lower dispersion and lower intensity in the average impact suffered
465 by the network after the AE due to the application of the proposed PAs. This is in comparison with
466 the component importance maps obtained for the AE of burst (Fig. ??). A low dispersion means
467 that fewer pipes are capable of generating a considerable impact in the system. Thus, the hydraulic
468 importance for pipes is concentrated at specific points of the network. The intensity in the maps
469 is directly related to the impact suffered in the system due to the closure of the associated area
470 components. In this paper low intensity is interpreted in terms of low resilience. The results are
471 detailed as follows:

- 472 • for **zone1** both PAs (minimum valley and maximum peak of demand evaluated), present a
473 smaller dispersion than that obtained for the AE at *maxImp* (Fig. ??; inset c for maximum
474 peak, and inset f for minimum valley). The intensity is shown to be larger for PA than for the
475 AE. This occurs in all cases except for the pairwise of dashed red circles (Fig. ??), whose
476 intensity is larger for AE than PAs. We compare zone1 at the maximum and minimum
477 demand requirements for each PA. The results show that the dispersion is very similar in all
478 cases but the intensity is often greater for the periods of minimum demand.
- 479 • **Zone2** and **zone3** are considered as the most critical areas for an AE. The results show that
480 zone2 preserves zone critical characteristics, whilst zone3 becomes into a not significantly
481 affected area for both PAs. This means that the impact of an AE is effectively mitigated
482 with the application of any of the two PAs proposed. Thus, the resilience for zone3 can be
483 improved through the implementation of actions providing a fast AE detection and isolation
484 of the affected components. At zone2 the dispersion is preserved for PAs. Thus, not
485 new components acquire hydraulic relevance after the implementation of PAs. Although
486 the intensity has been reduced for this zone with the application of PAs (SIA better than
487 MIA) the results show that PAs of isolation are not considerably effective to mitigate the
488 impact related to AE (specially for the period of maximum demand). There are required
489 adaptive actions and the consideration of “twining” pipes (creating loops for increasing the
490 topological redundancy of the network) for improving resilience.

- Neither AE of burst nor the application of PAs have a significant impact on the system's operation for **zone4**.

CONCLUSIONS

This paper contributes to progress on the implementation and quantification of the conceptual development of water distribution networks (WDNs) resilience. This is done by investigating the consequences of failure in the network components. The proposal is based on the three system capacities and focuses on the absorptive resilience phase of a pipe burst (anomalous event, AE). In addition, it takes into account two palliative actions (PAs) to mitigate any negative AE's effects. The first action is based on the exclusive isolation of the affected pipe (single isolation action - SIA). The second action considers the isolation of the surrounding area of the affected pipe (multiple isolation action - MIA). The impact on the network performance is evaluated for the two cases through the water demand satisfaction.

The paper introduces a novel tool-set for resilience indicators development. This counts on both network structure and energy's level availability. This is possible thanks to the hydraulic model used (Pressure driven model - PDM). The tool-set is tested by assessing the resilience of two case-studies. The proposed methodology is able to suitably identify the most critical components of a network working under unfavorable conditions (AE, SIA, and MIA). In addition, the information is presented by a novel visualization method showing component importance maps. This method has the advantage of allowing better results interpretation than only using numeric information. Component importance maps do not require user experience and can be used both to plan adaptive actions and to redesign the network.

The two case-studies highlight how important is to consider the burst position in the pipe both for practical network management and theoretical developments. Furthermore, estimating the burst position wrongly can lead to do not take proper actions and consequently bring cost overruns for water utilities. The results show the viability of using the analysis of the event in the absorptive phase of the system resilience as an assessment tool both for simple and complex cases. In addition, they lead to the following conclusions and recommendations:

- 518 • The isolation PAs for an AE point out SIA as the ideal isolation in comparison to MIA for
519 palliative actions. The results can be used for recommendations for valve placement. It
520 is recommended a configuration of isolation valves avoiding further network collapse. In
521 addition, if the closed zones are too large the system performance during isolation might be
522 highly affected.
- 523 • The results show that the effect of an anomalous event depends on the water demand. The
524 most critical condition of the network performance occurs in conditions of minimum water
525 demand. However, the PAs show a more critical behavior at the period of maximum water
526 demand. Therefore, given that the duration of the isolation of the affected area may be
527 longer (depending on the characteristics of the affected pipe) than the time of the leak, it is
528 recommended that adaptive actions should be evaluated for the maximum peak of demand.
- 529 • The comparison of the AE and the first action carried out for the water utility in the specific
530 time evaluated (time in which the first action is implemented in the system), has allowed
531 to generate possible system responses. The overall recommendation is to focus, firstly, on
532 those components that really require adaptive actions or some specific redesign, given the
533 inability of the network to compensate the losses of resilience due to the event.

534 The paper opens a research avenue for analyzing further the synergy between resilience key
535 performance indicators at different resilience stages. Additional investigation will be necessary for
536 assessing resilience of large-size networks divided in district metered areas.

APPENDIX I. DETECTION OF SURROUNDING AREA

This Subsection proposes labeling the sets of three proposed operative conditions of failure: AE, SIA, and MIA. The label directly marks the affected pipe among the set of links $E\{E1, \dots, Em\}$. MIA involves the isolation of an entire network area. The surrounding area indicator (termed by the author), **sai**, label the isolation pipes associated with MIA, Eq. (??).

$$sai_j = \left| \left(A_{(*,j)}^N \right)^T \right| |A^N|, \quad (7)$$

where j represents the link under operative conditions of failure; $(\cdot)^T$ denotes matrix transposition; and $|\cdot|$ represents the matrix of the absolute value of its elements, and $A_{(*,j)}$ is the column extracted from A indexed by j .

The row vector **sai** identifies the pipes that might be isolated in the network. The values obtained through Eq. ?? are 0, 1 and 2. A value equal to 2 refers to the affected pipe by an AE; a value equal to 1 identifies the surrounding pipes (to be isolated); and a value equal to 0 stands for pipes that are not involved in the current action (pipes that not require to be isolated). An instance of the surrounding area identification methodology (through the use of Eq. ??) is shown in Fig. ??.

It is possible to obtain the set of pipes to be isolated as consequence of the failure of j for MIA. This is by extracting the column number of the values different to zero from sai and, subsequently comparing these values with the list of pipes. For Fig. ??, we have the failures in pipe P4 represented as $E_4 = \{P3, P4, P5, P7, P8\}$. E_4 is the set of adjacent links to the nodes N4 and N5, pipe P4 end nodes. In case of having adequate information regarding valve locations, this methodology might be adapted for identification of real pipes that can ultimately be isolated in the network.

Data Availability

Some or all data, models, or code generated or used during the study are available from the corresponding author by request.

560 **Acknowledgments**

561 The work presented in the paper is part of the French-German collaborative research project
562 ResiWater that is funded by the French National Research Agency (ANR; project: ANR-14-PICS-
563 0003) and the German Federal Ministry of Education and Research (BMBF; project: BMBF-
564 13N13690).

TABLE 1. TLN network. Node and pipe properties.

ID	Nodes		ID	Pipes					Burst nodes		
	elev. (m)	dem. (L/s)		initial node	term. node	length (m)	diam. (mm)	H-W coef.	Position		C_d
									Pos0	Pos100	
T1	210	-	P1	T1	N2	1000	400	130	T1	N2	0.6
N2	150	27.8	P2	N2	N3	1000	400	130	N2	N3	0.6
N3	160	27.8	P3	N2	N4	1000	300	130	N2	N4	0.6
N4	155	33.3	P4	N4	N5	1000	400	130	N4	N5	0.6
N5	150	75.0	P5	N4	N6	1000	300	130	N4	N6	0.6
N6	165	91.7	P6	N6	N7	1000	400	130	N7	N6	0.6
N7	160	55.6	P7	N3	N5	1000	400	130	N3	N5	0.6
-	-	-	P8	N5	N7	1000	400	130	N5	N7	0.6

TABLE 2. Resilience results - AE of burst

Demand	Fig. ??	Impact		
	Inset	minimum	medium	maximum
maximum	a.	99.39	96.27	51.60
	b.	99.39	96.07	51.33
	c.	99.39	95.55	51.07
minimum	d.	99.27	96.12	45.28
	e.	99.27	95.93	44.98
	f.	99.27	95.43	44.68
General	-	99.39	95.90	44.68

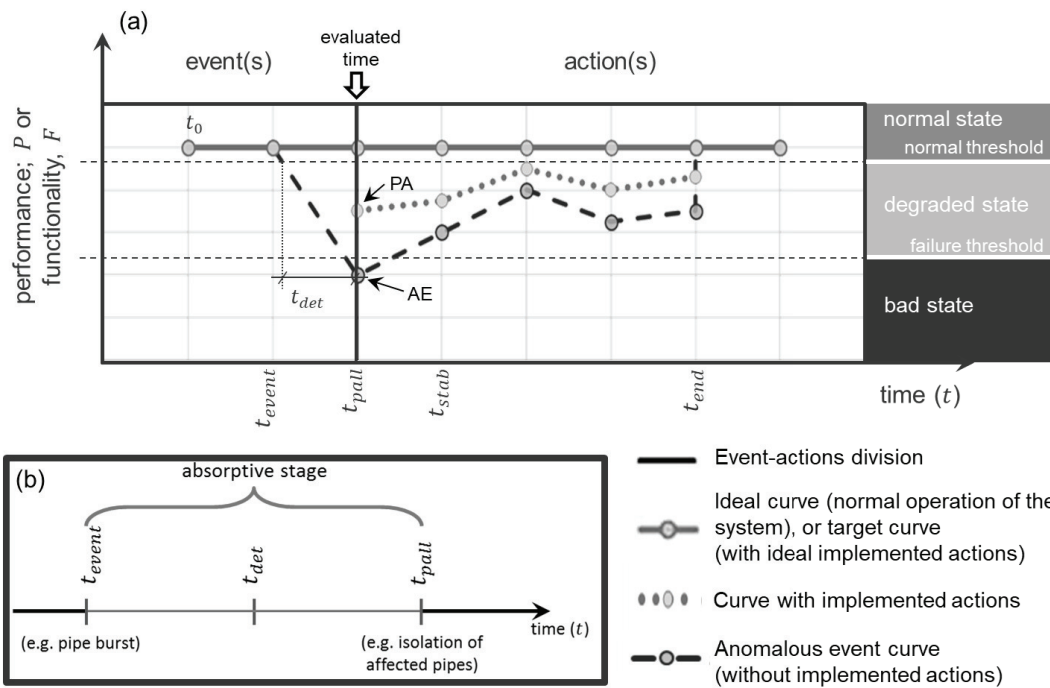

Fig. 1. Anomalous events in a WDN – Resilience curve. (a) Temporal-technical dimension of the resilience, and (b) absorptive phase - times.

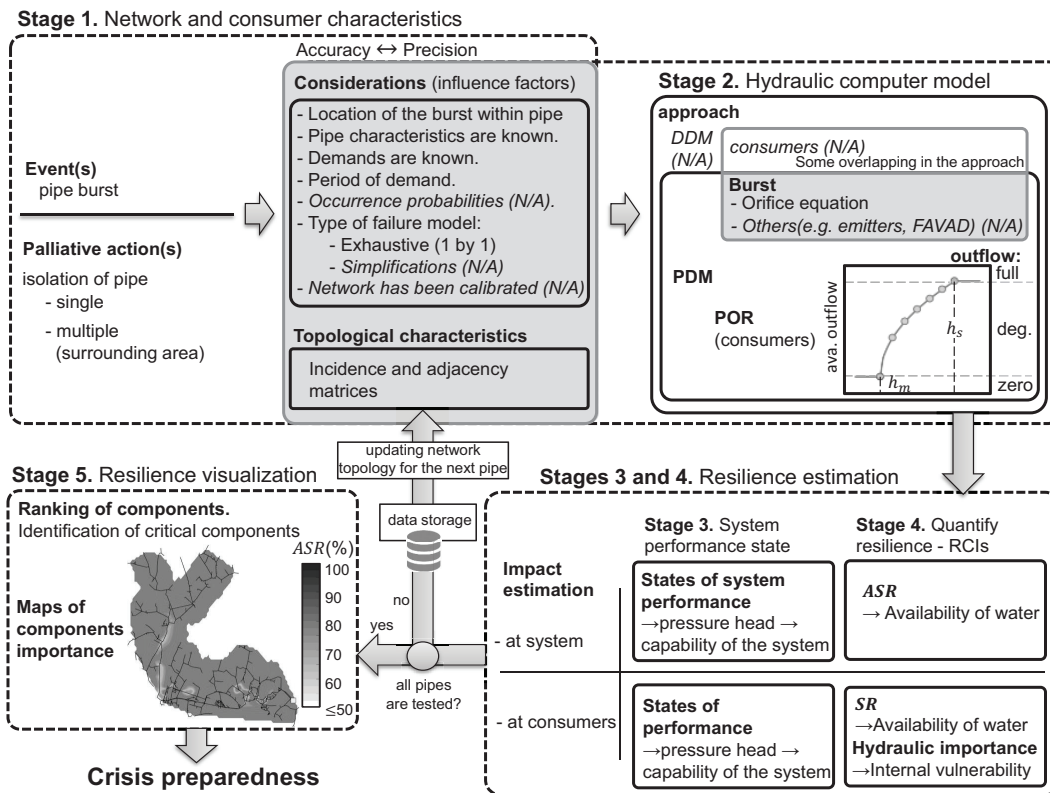

Fig. 2. Overview of the proposed network resilience quantification process.

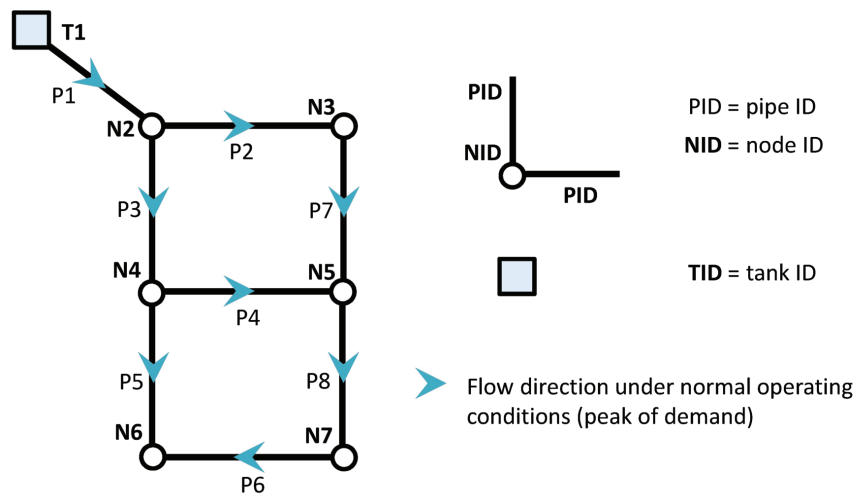

Fig. 3. TLN network. Network layout configuration, and flow directions.

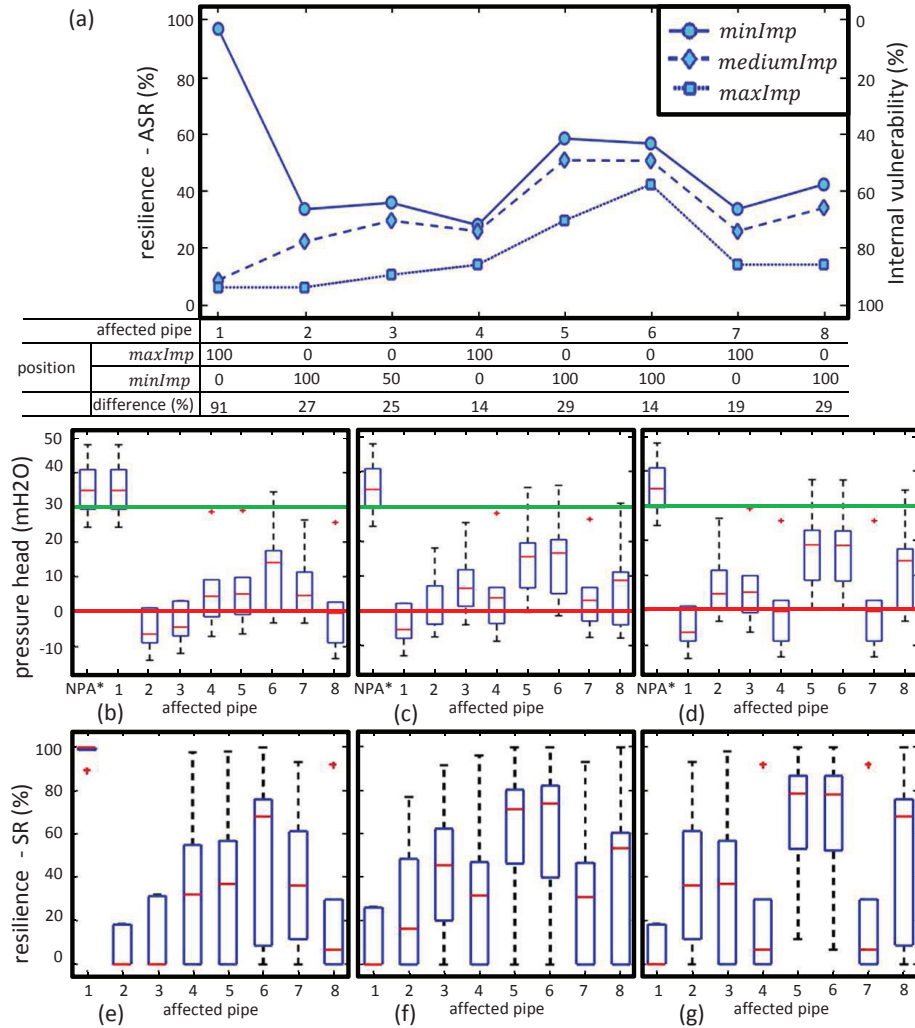

Fig. 4. TLN network - pipe burst. (a) Network impact, (b-d) pressure heads and (e-g) water availability. (b and e) Pos0, (c and f) Pos50, and (d and g) Pos100. NPA*: Non-pipe affected.

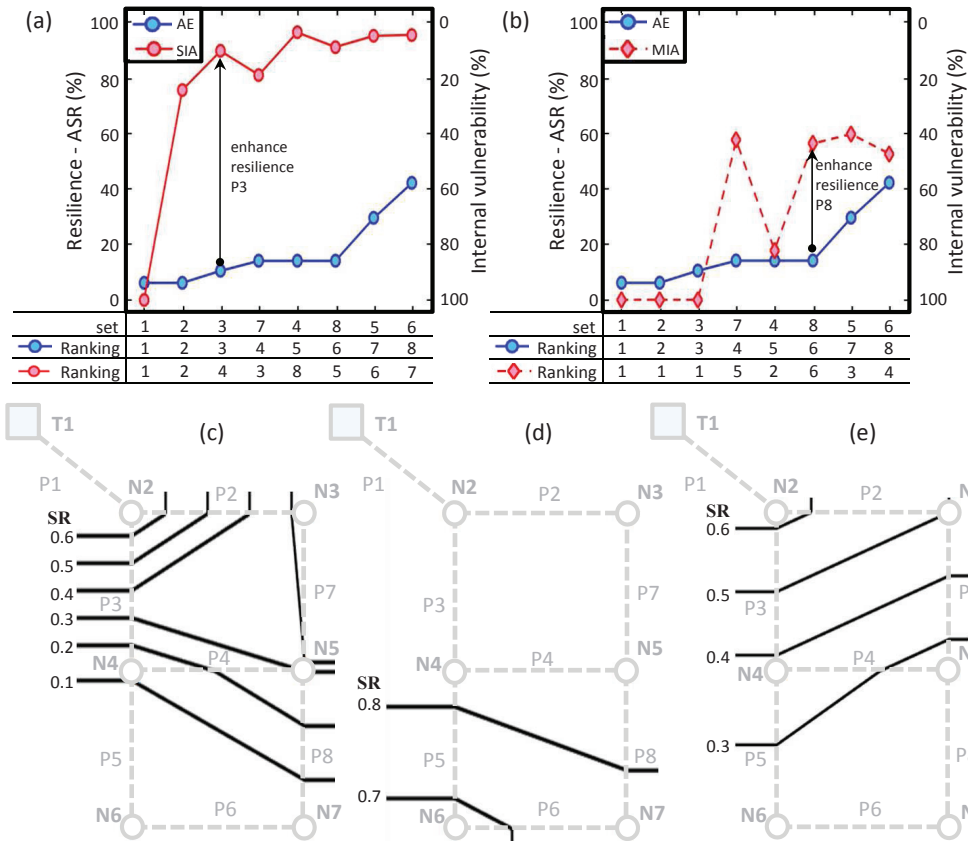

Fig. 5. Burst event and isolation actions – TLN network. **(a-b)** Impact of the failure, and **(c-e)** SR isoclines. **(a)** AE and SIA, **(b)** AE and MIA, **(c)** AE, **(d)** SIA, and **(e)** MIA.

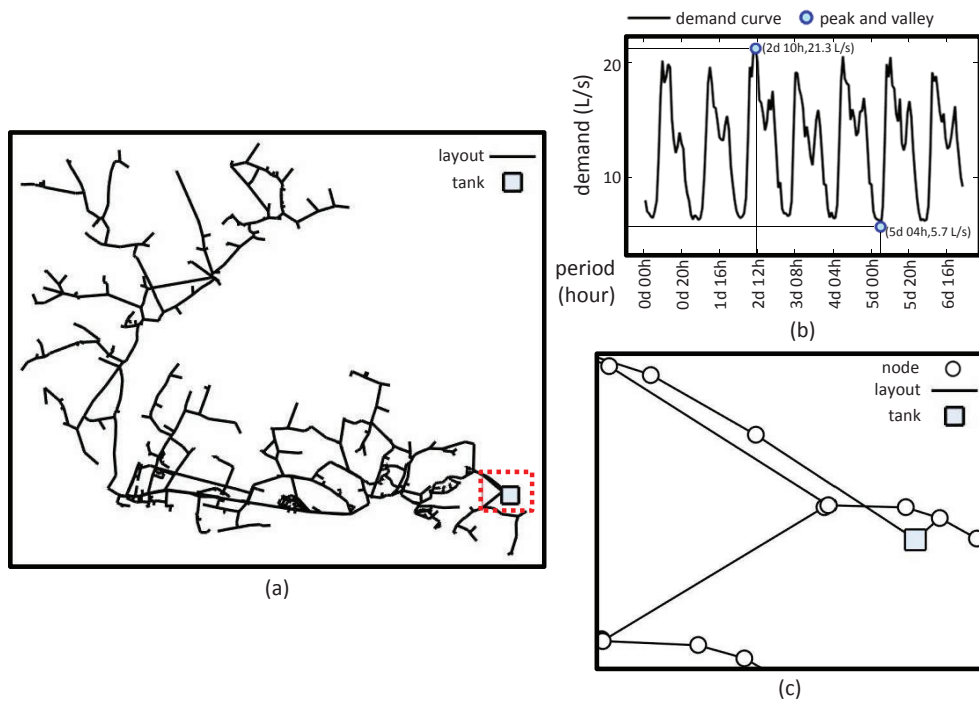

Fig. 6. Complex case-study. **(a)** Network layout, **(b)** demand curve, and **(c)** zoom of red dashed rectangle – nearby area for the tank.

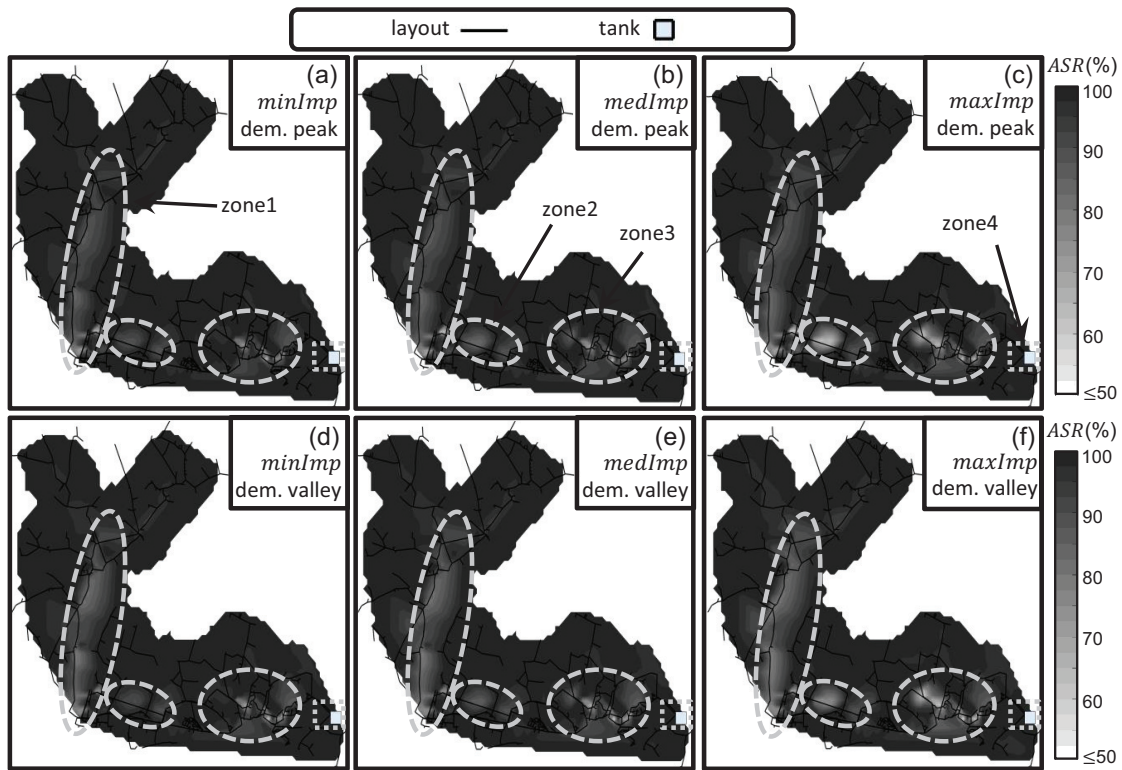

Fig. 7. Resilience based on *ASR*, maps of component importance for AE of Burst. Quantification of the average impact – complex case. **(a-c)** Maximum peak of demand, and **(d-f)** minimum valley of demand. **(a and d)** *minImp*, **(b and e)** *medImp*, and **(c and f)** *maxImp*.

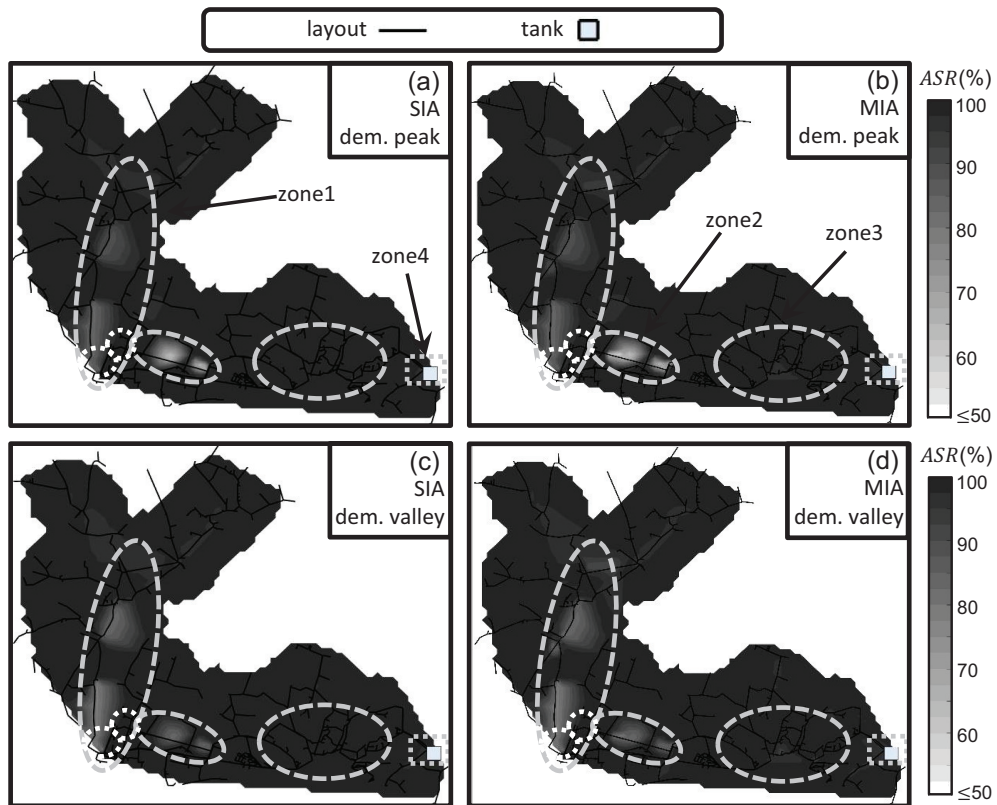

Fig. 8. Resilience based on *ASR*, component importance maps for SIA and MIA. Quantification of average impact – complex case. (a-b) Maximum peak of demand, and (c-d) minimum valley of demand. (a and c) SIA, and (b and d) MIA.

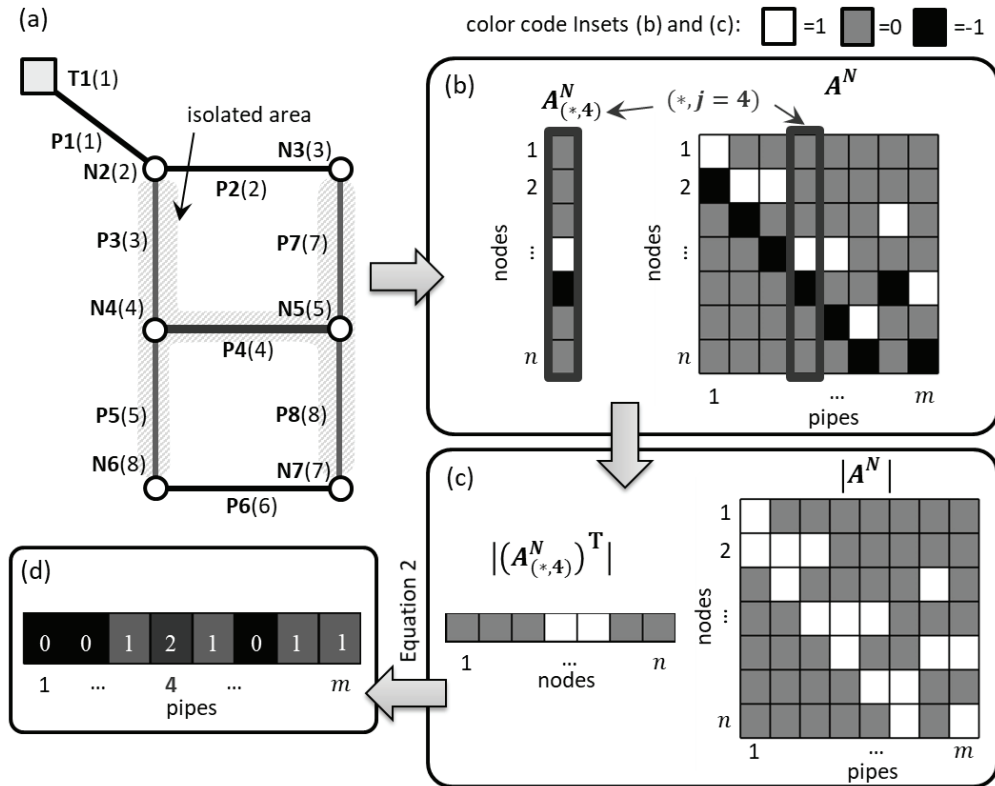

Fig. 9. Surrounding area identification. Example of application of the Eq. ?? applied to a particular pipe ($P4$ in this case). (a) Network layout, (b) incidence matrix and its respective column vector for the affected pipe, (c) undirected incidence matrix and its respective undirected column vector (transposed) for the affected pipe, and (d) surrounding area indicator.