



HAL
open science

Efficient Embedded System Development: A Workbench for an Integrated Methodology

Nicolas Hili, Christian Fabre, Sophie Dupuy-Chessa, Stéphane Malfoy

► To cite this version:

Nicolas Hili, Christian Fabre, Sophie Dupuy-Chessa, Stéphane Malfoy. Efficient Embedded System Development: A Workbench for an Integrated Methodology. Embedded Real Time Software and Systems (ERTS2012), Feb 2012, Toulouse, France. hal-02191869

HAL Id: hal-02191869

<https://hal.science/hal-02191869>

Submitted on 23 Jul 2019

HAL is a multi-disciplinary open access archive for the deposit and dissemination of scientific research documents, whether they are published or not. The documents may come from teaching and research institutions in France or abroad, or from public or private research centers.

L'archive ouverte pluridisciplinaire **HAL**, est destinée au dépôt et à la diffusion de documents scientifiques de niveau recherche, publiés ou non, émanant des établissements d'enseignement et de recherche français ou étrangers, des laboratoires publics ou privés.

Efficient Embedded System Development: A Workbench for an Integrated Methodology

Nicolas Hili*, Christian Fabre*, Sophie Dupuy-Chessa**, Stéphane Malfoy***

nicolas.hili@cea.fr – christian.fabre1@cea.fr – sophie.dupuy@imag.fr – smalfoy@telsys.ch

* CEA LETI, bât. CTL, 7 av. de palestine, ZI de mayencin, F-38610 GIÈRES, FRANCE.

** LIG, bâtiment IMAG C, 220 rue de la chimie, F-38400 SAINT-MARTIN-D'HÈRES, FRANCE.

*** Telecom Systems SA, En Budron E7, CH-1052 LE MONT SUR LAUSANNE, SUISSE.

ERTS² 2012, February 1st–3rd, Toulouse, France

Keywords : Process Methods & Tools, Model-Based System Engineering, Project Management, Progress Tracking, Co-Development, Traceability, Engineering Refinements.

Abstract

The scientific foundations of embedded system development associate two disciplines that have largely grown on their own: computer science and electrical engineering. This superposition of two domains with little common ground raises a number of industrial issues in team work organisation, sound progress tracking, and cooperation between these different skills and cultures. In this paper we introduce $\langle\text{HOE}\rangle^2$, an integrated MDE method for embedded system development that is organised around a set of limited yet powerful artefacts. We describe how $\langle\text{HOE}\rangle^2$ can address the issues faced during development of mixed HW/SW systems and present the first version of a tool dedicated to its instrumentation.

1 Introduction

Unlike other disciplines like civil engineering, embedded systems is a very young domain from both a scientific and an engineering point of view. There is a lack of unifying scientific foundation, as computer science and electrical engineering have evolved mostly separately so far [7]. Embedded system development teams have also to cope with the

usual constraints of industrial organisations whose main target is efficiency of teamwork at large. Critical industrial concerns related to embedded system development include the following. **End-to-End Engineering:** The full development cycle goes from requirement formalisation to the final integration and assessment of the application on its platform. **Hardware/Software Co-Development:** HW & SW do not require the same set of skills. They are developed mostly independently while the quality of the final product highly depends on the smooth integration of both. **Incremental & Collaborative:** To organise efficiently the work of a large team, it is critical to regularly show and measure progress towards the objectives.

This paper presents the *Highly Heterogeneous, Object-Oriented, Efficient Engineering* method, shortened in $\langle\text{HOE}\rangle^2$. *Highly Heterogeneous* because it aims to address both software (application code, middleware, operating systems, etc.) and hardware (ASIC, FPGA, etc.) development. *Object-Oriented* since $\langle\text{HOE}\rangle^2$ models are made of objects linked by association and communicating through exchange of messages. *Efficient Engineering* as it addresses industrial issues like traceability to requirements, team work synchronisation, in an integrated fashion.

The rest of this paper is organised as follows: section 2 presents related work. Section 3 introduces $\langle\text{HOE}\rangle^2$. Section 4 applies it on a case study. And finally section 5 presents a first version of a tool that supports $\langle\text{HOE}\rangle^2$.

2 Related Work

Seligmann, Wijers & Sol characterise a method in four ways: a *way of thinking* (the approach), a *way of organising* work (the process), a *way of modelling* (the models) and a *way of supporting* work (the tools) [20]. We will use their characterisation throughout the paper.

Modelling Languages. The standard way to model software systems is currently UML (Unified Modeling Language) developed by the OMG (Object Management Group) [17]. UML is a graphical language that provides several kinds of diagrams, e.g. class diagram, sequence diagram, state-machine diagram. It has its roots in software modelling and is not bound to any specific domains. One area where plain UML falls short is Real-Time Embedded Systems (RTES). OMG proposed the MARTE profile for RTES development [15], and an extension for system engineering called SysML [16].

Several developments made with MARTE have been published. In [4], Demathieu et al. present first experiments using MARTE on the Josefil case study. They highlight the lack of UML for modelling RTES and present how MARTE was specified to fill the gap of UML. In [22], Vidal et al. propose, among other things, a MARTE profile for platform modelling and VHDL code generation.

Processes. Of the ever increasing complexity of embedded systems, trend focused on combining methodologies related to both software (language-based methodologies) and hardware (synthesis-based methodologies) development [8]. Many actors have contributed to this model-based trend. OMG proposed a new approach called Model-Driven Architecture (MDA) whose the three main goals of MDA are portability, interoperability and reusability [14]. MDA is based on the separation between the declaration of the application and its platform.

MDA is seen as a simplified vision of Model-Driven Engineering (MDE). MDE defines a software development approach which puts creation of models forward essentially and focuses on simple, transformable and manipulable models [5, 3]. MDE uses open standards like UML, and is based on several concepts (Executable models, transformations towards a specific platform, weaving).

With this new trend whose model is the central artefact, teams have to be organised through new working methods and development life cycles. Life cycles propose a defined number of phases and guide the developer in its work. Numerous processes have been proposed. The key properties are iterative and incremental, reusability of components, traceability across development from requirement to implementation, etc. Typical life cycles are Y life cycle, Waterfall life cycle or Twin Peaks life cycle [12, 13, 2].

Most Y-shaped life cycles share the following organisation: the top-left branch represents the functional or application-related aspects of the development. The technical or platform-related aspects are captured in the top-right branch. And the central branch deals with integration of the application on the platform.

Capretz proposes in [12] a component-based Y life cycle which emphasises on the need of creating reusable components. This life cycle relies on a separation between technical and functional aspects. It is built on ten planned phases which are domain engineering, frameworking, assembly, archiving, system analysis, design, implementation, testing, deployment and maintenance. Its particularity is to incorporate the concern of reusability inside its life cycle.

In 1999, Unified Software Development Process (USDP) was born [11]. USDP is an iterative and incremental development process for software area. It is generic framework customizable for specific projects. Related to USDP are UP-based processes like Rational Unified Process (RUP) and *Processus de Développement de Systèmes Industriels* (PDSI) [10, 18].

Based on UML, PDSI derives from USDP. It was proposed for distributing and communicating RTES and it is based on only four phases. PDSI claims a code reusability rate around 30% for the second project, and 50% for the third.

If these unified processes are the closest to our needs, almost do not clearly describe the transitions between each phase. Besides, no project management is integrated into them. They shall define regular checkpoints when it would be interesting to measure working progress etc.

Iterative and incremental notions are particularly important in Agile software development [1, 9]. Agile software development is a set of relevant

practices for software development. It proposes an iterative and incremental development and is found on four values: team and interactions, working software, customer collaboration and responding to change. In Agile software development, customers are an integral part of the development. Although Agile software development has proved its values in a Information System (SI) area, it is not applicable to embedded systems where software can not be independently developed without hardware. Besides, Agile software development does not explain what artefacts have to be produced and how they are produced. This shortcoming explains why Agile methods are often coupled with another development processes.

To summarise, some approaches propose well defined concepts but there is no team organisation whatever (e.g. life cycles). Others define the way teams must be organised but do not explain what artefacts have to be produced (e.g. Agile methods). Among those who say how the activities are organised, the transitions between each phase are not well described (e.g. USDP). Processes imprecision, lack of guidance and project management inside current methods, processes non-applicable to both application and platform, etc. led to the proposition of new model-based methods.

Next section will present the $\langle\text{HOE}\rangle^2$ method.

3 The $\langle\text{HOE}\rangle^2$ Method

For our model-based method, we decided to rely on existing concepts used by others methods : an incremental development through an iterative approach from Agile software development, reusability of components from Y model, independence of the platform by which MDE advocates that system specification must be independent from a specific platform.

This section presents the *Highly Heterogeneous, Object-Oriented, Efficient Engineering* method. The method is organised around four successive models which branch off each other by three *Engineering Refinements* used to build those models gradually – see Fig. 1. The basic $\langle\text{HOE}\rangle^2$ approach is the following one.

Requirement Model. The informal requirements are analysed and a *Requirement Model* is

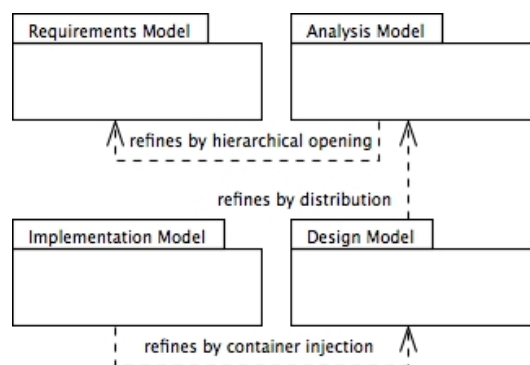

Figure 1: The Four $\langle\text{HOE}\rangle^2$ Models

built. This static model includes the *system*, its *actors*, its *use cases* and their *scenarios*. Fig. 2 presents the Requirement metamodel that covers all notions defined above.

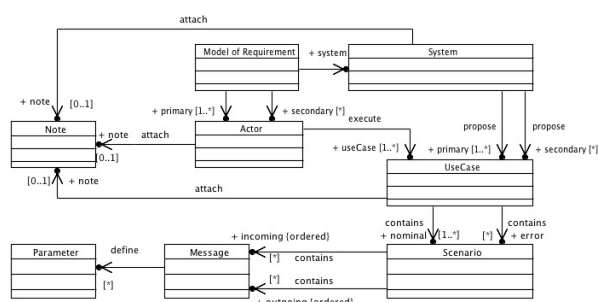

Figure 2: Requirement Metamodel

Analysis Model. This model is then refined into an executable, platform-independent *Analysis Model*. It is built through several, possibly recursive, *Hierarchical Openings* of *objects*. This refinement replaces an object with a set of objects that collectively exhibit the same apparent behaviour – see Fig. 4. Fig. 3 presents a piece of the Analysis metamodel.

Design Model. The *platform* is introduced partially by declaring its *worlds*. We define a platform as – within the meaning of MDA [14] – a set of subsystems providing resources and hosting objects. A world is an abstraction for an execution domain that hosts objects – like a Digital Signal Processor (DSP), a set of processors and their shared memory, a FPGA, or a future dedicated hardware IP.

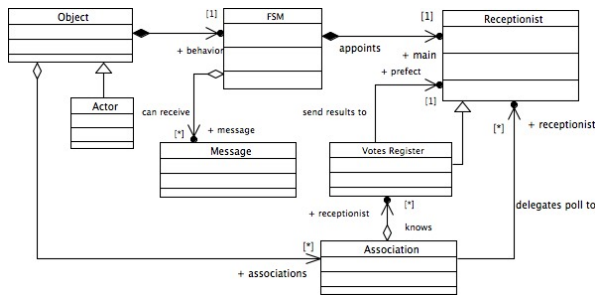

Figure 3: Analysis Metamodel

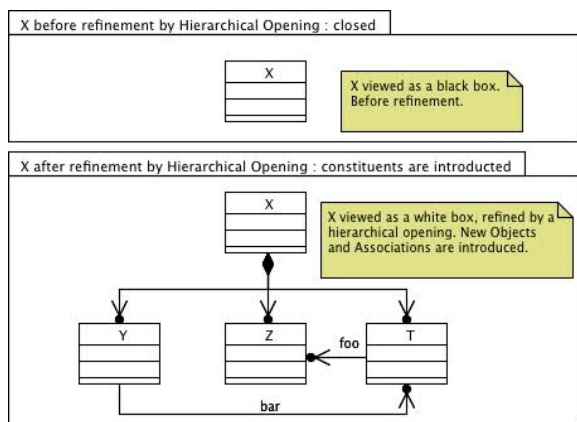

Figure 4: Hierarchical Opening

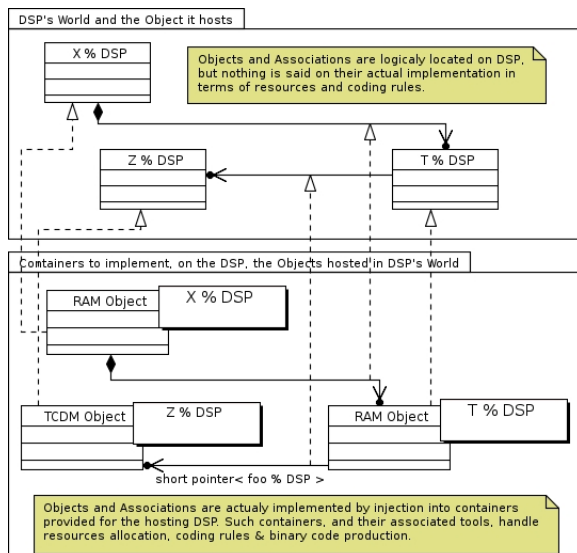

Figure 5: Container Injection

An executable *Design Model* is built, in which each object from the Analysis Model is *distributed* over the platform worlds – that is cut in slices with each slice hosted in a world, as shown Fig. 5.

To summarise, in the design phase we introduce a description of the platform limited to declaration of the worlds it supports. Then we distribute the analysis objects and associations on these worlds.

Implementation Model. On the occasion of the implementation phase, the platform is now further detailed: for each world, several *containers* are provided. Each of them embodies a given trade-off to implement object behaviour on the target execution domain. The *Implementation Model* is then built by *Injecting in a Container* each object of the Design Model – see Fig. 6.

In this paper, we do not discuss further the semantics of container injection. But in a few words, an injection is legit if and only if the behaviour of the design model of an object is a proper abstraction of the behaviour of its implementation model.

4 The Camera Case Study

In order to illustrate the $\langle \text{HOE} \rangle^2$ method, we will introduce a sample embedded system: a camera. This system covers the device that captures and stores the image. So as to make the example as simple and comprehensible as possible, we imagine a simple camera which lets the photographer take pictures and store that pictures into an internal memory. After taking a picture, the photographer can delete that picture, or list all pictures. Problems about memory will be ignored, in order to reject all use cases bound to the last one (“Store a Picture” at applicative level, “Check Available Memory Space” at platform level, etc.).

This section is organised as follows: first we will apply for this paper the first two phases of $\langle \text{HOE} \rangle^2$ method to the camera and its platform. Next, we will show how it addresses industrial concerns. Finally, we will discuss industrial methods related to $\langle \text{HOE} \rangle^2$.

4.1 The Camera as a Case Study

Requirement Model of Camera. Fig. 7 shows the requirement model of the camera. We identified one actor, the photographer. Camera proposes

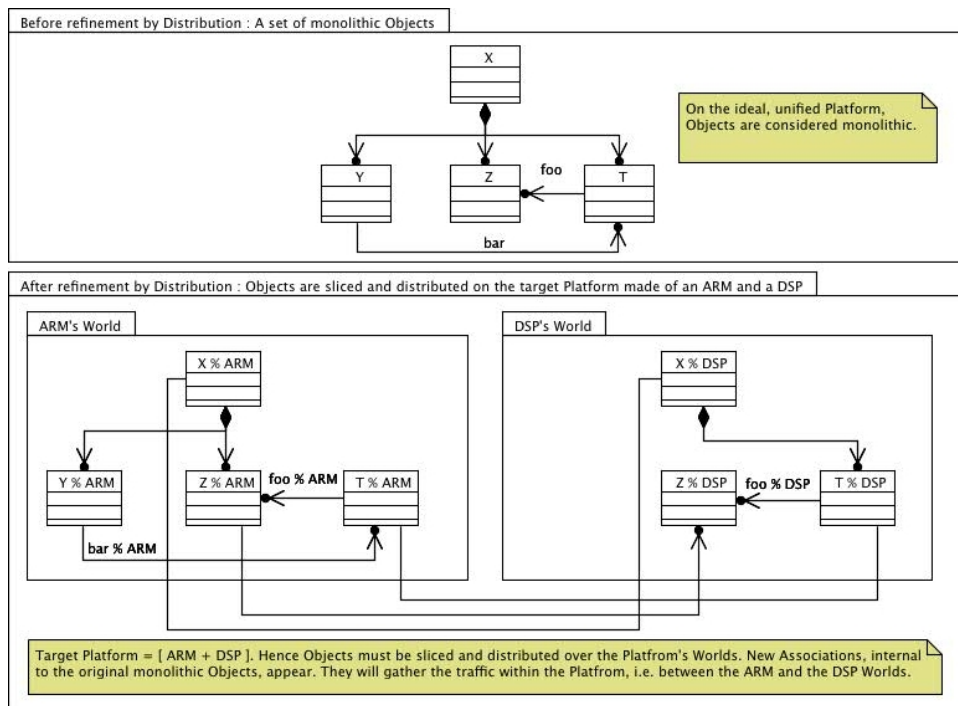

Figure 6: Distribution

four identified use cases. Only “Take a Picture” and “Toggle Flash” use cases will be studied in this paper. We introduce here two stereotypes to classify actors and use cases regarding the system. These stereotypes are « *Primary* » and « *Secondary* ». A use case is labeled “Primary” when it is a cause of the system (the camera is designed to take pictures) and “Secondary” when it is a consequence of the system (the flash is a feature of advanced cameras).

For each studied use case, we identify nominal and error scenarios. A scenario is labeled “Nominal” when it represents the nominal sequence of message exchanges between the actor and the system. An unexpected message or error causes the identification of an error scenario. Fig. 8 below shows a nominal (Fig. 8(a)) and error (Fig. 8(b)) scenarios of “Take a Picture” use case.

Note that both nominal and error scenarios from a same use case are activated by the same triggering event.

Use cases may have more than one nominal scenario, as well as they may own no error scenario. Fig. 9 presents two nominal scenarios of “Toggle

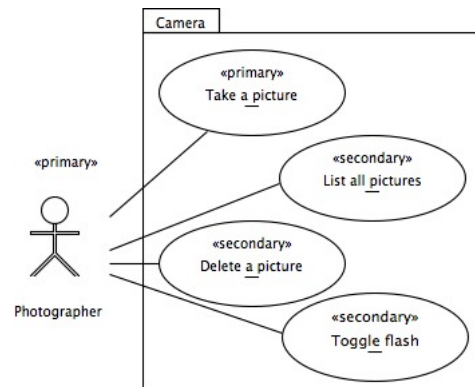
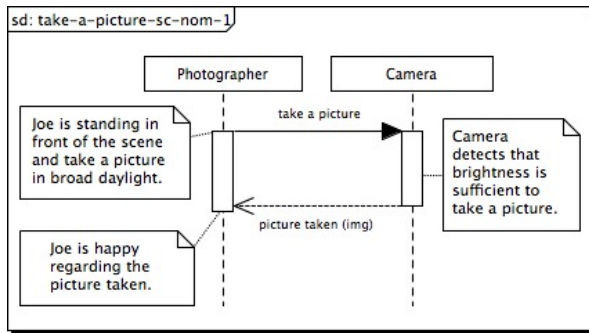

Figure 7: Requirement Model

Flash”. The second is an alternative of the first one. Both have the same triggering event. The internal behaviour of the camera (more specifically the flash) will let us know which scenario will be played.

Analysis Model of Camera. We have now captured a piece of requirement model, we can further extend our study. Fig. 10 shows the first hierar-



(a) Nominal Scenario

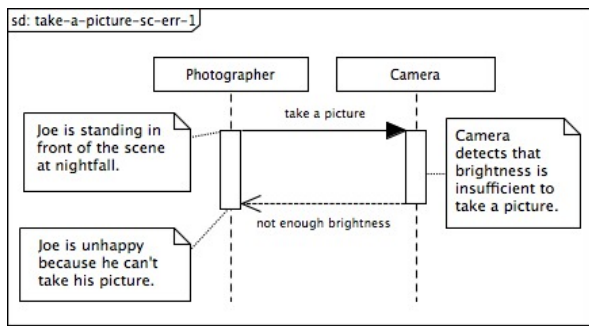

(b) Error Scenario

Figure 8: Scenarios of “Take a Picture”

chical opening of the camera. Before opening, the system appears as a black box (Fig. 10(a)). This opening reveals new objects (Fig. 10(b)): a sensor, images and also a flash. This opening might be done in more than one iteration, first iteration where we would have identified the sensor and images so as to answer three first use cases specification, and a second iteration to discover a new object, the flash.

After carrying out the first opening of the camera, we can now refine all scenarios from the requirement model. Fig. 11 shows the refinement of the nominal scenario of “Take a Picture” use case. We can see that both triggering event and final answer from the system to the actor have not changed regarding the scenario in requirement model.

Dynamic aspects of each object are described from an analysis model by a Finite State Machine (FSM). The FSM points out what messages can be emitted or received by the object, and how the messages are interpreted. Due to space limitation, the dynamic aspect are not addressed here.

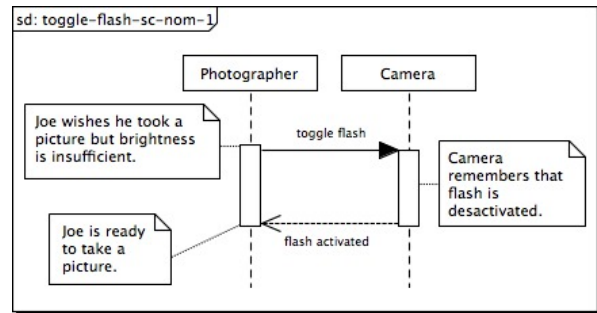

(a) Nominal Scenario

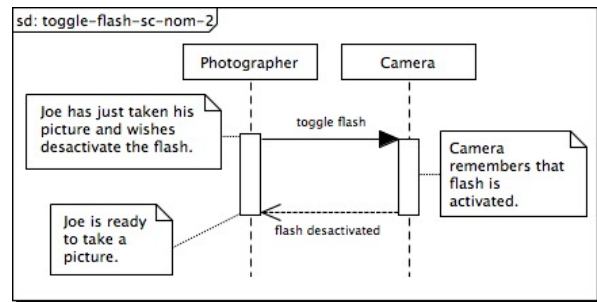

(b) Nominal Scenario 2

Figure 9: Scenarios of “Toggle Flash”

Platform of the camera. The whole process of (HOE)² can be applied at application level as well as platform level. In this paper, we will tackle only the requirement model for the platform.

As shown in Fig. 12, we identify two use cases for the platform of the camera. Only one is studied here, the “Install New Firmware” use case. It lets the identified primary actor – Administrator – install new firmware on the platform. Two scenarios have been captured for this use case (see Fig. 13(a) and Fig. 13(b)). The firmware to be installed is described as an object and passed as parameter to the platform, becoming a *Shared Object* of the requirement model – shared between an actor and the system. We can imagine several error scenarios, like “Corrupted Firmware”, “Attempt to Install Older Version of Firmware”, etc. The firmware is captured as the design model of the camera, and is the point of contact between the application and the platform development tracks.

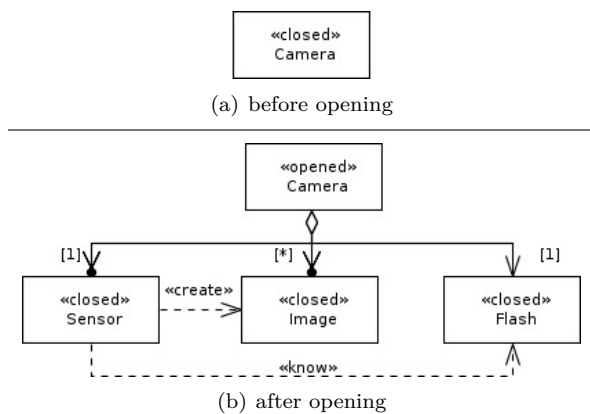

Figure 10: 1st Opening of Camera

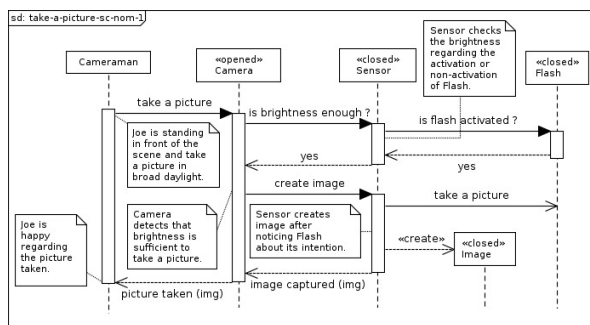

Figure 11: Refinement of Scenarios from Requirement Model

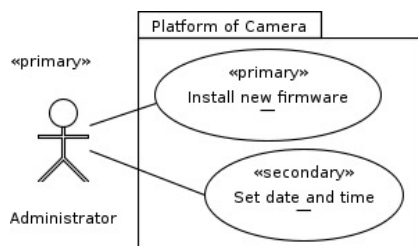
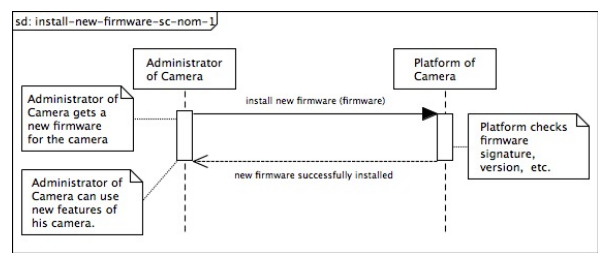

Figure 12: Requirement Model of Platform

4.2 How $\langle HOE \rangle^2$ Addresses Industrial Concerns

As we mentioned, $\langle HOE \rangle^2$ has a small number of refinements and its models are precisely ordered. Three models out of the four are executable (i.e. they can be simulated or used to generate code) – only the requirement model is not. All this provides a number of side effects that can be exploited to address industrial concerns:



(a) nominal scenario

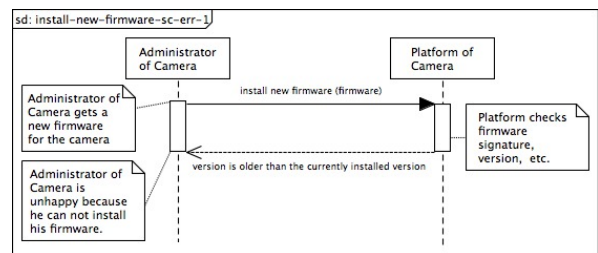

(b) error scenario

Figure 13: Scenarios of “Install New Firmware”

Traceability to Requirements: As the *Analysis*, *Design* and *Implementation* models are executable, they can be checked for conformance against the *Requirement Model*'s scenarios.

Non-Functional Analyses through Simulation: Instrumentation of models before and during execution enables non-functional property analyses, like performance analysis, through external tools and simulation.

Team Work: The ability to execute and animate models provide for a better understanding for all stakeholders of the system under construction.

Iterations/Increments: The strict ordering of models can be the basis of iteration planning strategies. Fig. 14 shows the two axes involved in iteration planning: requirement depth and process width.

Separation of Skills: The gradual introduction of the platform – first a pure topological description, then extended with its containers – can be the basis of *divide and conquer* project management strategies. For instance, although application architects can be involved from requirement to design, the fine grain details of implementation can

be handed to specialists of the platform, and be captured in containers definition and injection.

Toward a Platform Specific Model: $\langle\text{HOE}\rangle^2$ defines notions of Platform independent model (PIM) and Platform specific model (PSM) such as those depicted in [14]. $\langle\text{HOE}\rangle^2$ explains how we hand PIM on to PSM.

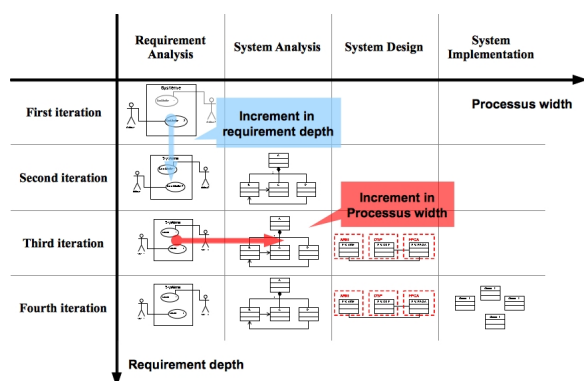

Figure 14: Two Sets of Orthogonal Increments

4.3 Related Industrial Methods

$\langle\text{HOE}\rangle^2$ is loosely based on USDP. It shares common grounds with industrial processes for embedded systems, like PDSI.

The most obvious similarities are the following: a strict definition of what is a use case, in particular its unique triggering event; the absence of internal actors; the analysis phase where objects are purely abstract and platform-independent, followed by the design phase where objects are cut in pieces and dispatched onto worlds; the replay of scenarios as the main evidence of progress; pervasive simulation to ensure model consistency and sharing across team members; a host of development traceability from requirement to implementation; a host of opportunities for simulation to analyse various kinds of properties on the model.

The main difference are: clear separation between design and implementation: first introduction of the pure topology of the platform in Design, then of Container Injection for local code production in Implementation; the claim that the three refinements discussed below are necessary and sufficient to develop and model embedded systems.

Although not presented in this paper, $\langle\text{HOE}\rangle^2$ is based on a key assumption: the four-phases process can be applied to the application *and* its platform, and the points of contact between the two models are limited and precise. This assumption opens the door to a fully integrated process that would cover the complete life cycle of embedded systems, from requirement and exploration to implementation, and from application to dedicated IP development. Such an integrated process is the ultimate goal of $\langle\text{HOE}\rangle^2$.

5 A Tool to Support the Method

So as to take part in the good development of $\langle\text{HOE}\rangle^2$, we decided to develop a tool to support the key point of the method: tight integration of artefacts involved in development with those used to build consistent and efficient project management strategies. The tool will emphasise practical organisation of iterations based on the three refinements used in $\langle\text{HOE}\rangle^2$ as a means for efficient project management.

This section is structured as follows: first part will state our needs about modelling tools and platform development while second part will present a first version of the tool developed on the chosen development platform.

5.1 Tool Design

Each level of model will have an editor dedicated to its own refinement. Navigation in the models will be based on the logical ordering of refinements within models. The project management tool will support consistent planning and definition of iterations obeying the model refinement dependencies. The iteration history will be navigable.

User interface of our tool has to be split into three areas at a minimum:

Editor Area: An editor area which can be shared by the different textual and graphical editors of each phase. For the graphical editors a palette has to be displayed and we must be able to drag and drop the entities from it. The information about the entities may be modified graphically in the editor, or in a property panel.

Navigator Area: A navigator lets us navigate inside our models. The navigator must be intuitive.

View Area: This area is dedicated to the project management and team work tools. We need to display some information like project management, team work, or some views to display and modify information about the entities selected in the active editor.

5.2 Tool Implementation

We chose to develop our tool on the Eclipse platform. It lends itself rather well to our tool (Perspective Management, Common Navigator Framework, Ecore Standard, etc.). It provides some tools to easily display multi-editors in the editor area, navigator and views.

The first step is to derive a well-formatted Ecore metamodel from our canonical metamodel. This step is fundamental since we need to consider the Ecore and its associated tool specificities. Fig.15 shows our requirement metamodel conformed to Ecore model.

Once we have produced our Ecore metamodel, we can apply the whole process of editor generation with the Graphical Modeling Framework (GMF) tools. GMF is a way to easily develop graphical editors binding Ecore model to the Graphical Editing Framework (GEF) architecture [6]. We chose GMF rather than GEF for some reasons: defined and guided GMF process, model-based development, quick generation of graphical editors and reduction of coding errors.

Fig. 16 shows our tool. It provides an editor dedicated to the requirement model, a simple navigator on its left and a property panel below the editor area. The editor was generated from the GMF dashboard [6], according to the Ecore Requirement Metamodel defining in Fig. 15.

6 Conclusion & Future Work

We have described (HOE)², a method for embedded systems development. We have detailed its organisation in four models and three refinements. We have also presented the first version of a tool that implements a subset of the method.

From this point, we will improve our tool on process width and requirement depth tacks. First in

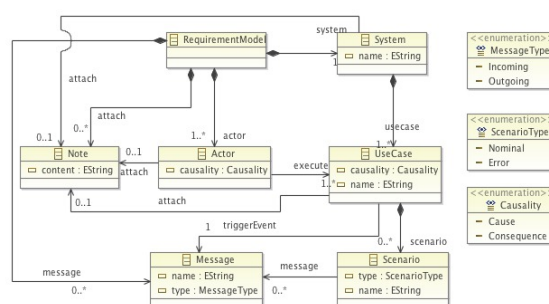

Figure 15: Ecore Requirement Metamodel

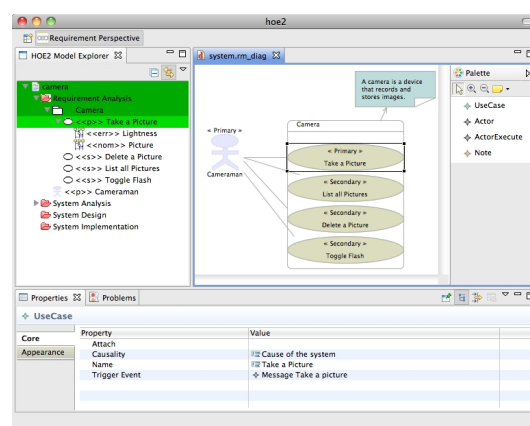

Figure 16: The Workbench

process width, we will formalise the other stages of the (HOE)² approach: design and implementation. Next in requirement depth, we will extend our requirement and system metamodels with scenarios, objects, FSM, etc. and by implementing traceability between the models.

We only focus on notions from UML. As we said in section 2, UML is not well-suited for embedded systems. We need to study the integration of notions from MARTE, SysML and other profiles intended to add notions about embedded systems.

On the longer term, one of the key asset of (HOE)² is its executable models. External tools can provide feedback on the model, either through static analyses or simulation. This is clearly a key opportunity, as support for regular and systematic feedback on the model through out the development flow is not as pervasive in the embedded system industry as it is in other industries, like civil engineering and mechanics.

7 Acknowledgements

Christian Fabre & Stéphane Malfoy would like to thanks Bernard Rygaert, a former colleague from Groupe SILICOMP / ORANGE Business Services. Bernard was the leader and architect of PDSI, and he introduced them to the basics of simple, elegant and efficient object-oriented modelling.

The authors wish to thank Dominique Rieu for her comments for the paper and the discussions they have had around several modelling concepts.

Most pictures and diagrams presented in this paper have been made with the Papyrus MDT modeling tool, developed by CEA LIST, now part of the Eclipse Modeling Framework [21, 19].

Last but not least, the authors would like to thank the reviewers of the extended abstract version of this paper for their insightful comments and suggestions.

References

- [1] Kent Beck, Mike Beedle, Arie van Bennekum, Alistair Cockburn, Ward Cunningham, Martin Fowler, James Grenning, Jim Highsmith, Andrew Hunt, Ron Jeffries, Jon Kern, Brian Marick, Robert C. Martin, Steve Mellor, Ken Schwaber, Jeff Sutherland, and Dave Thomas. Manifesto for Agile software development, 2001. <http://agilemanifesto.org>.
- [2] B. W. Boehm. A Spiral Model of Software Development and Enhancement. *Computer*, 21(5):61–72, May 1988.
- [3] Jean Bézivin. On the Unification Power of Models. *Software and Systems Modeling*, 4:171–188, 2005. 10.1007/s10270-005-0079-0.
- [4] S. Demathieu, F. Thomas, C. Andre, S. Gerard, and F. Terrier. First Experiments Using the UML Profile for MARTE. In *Object Oriented Real-Time Distributed Computing (ISORC), 2008 11th IEEE International Symposium on*, pages 50–57, May 2008.
- [5] Jean-Marie Favre, Jacky Estublier, and Mireille Blay-Fornarino, editors. *L'Ingénierie Dirigée par les Modèles : au-delà du MDA*. Informatique et systèmes d'information. Hermes Lavoisier, 2006.
- [6] Richard C. Gronback. *Eclipse Modeling Project A Domain-Specific Language (DSL) Toolkit*. The Eclipse Series. Addison Wesley, 2009.
- [7] Thomas A. Henzinger and Joseph Sifakis. The Discipline of Embedded Systems Design. *Computer*, 40(10):32–40, October 2007.
- [8] Tom Henzinger and Joseph Sifakis. The embedded systems design challenge. In *Proceedings of the 14th International Symposium on Formal Methods (FM), Lecture Notes in Computer Science*. Springer, August 2006.
- [9] Jim Highsmith and Martin Fowler. The Agile Manifesto. *Software Development Magazine*, 9(8):29–30, 2001.
- [10] IBM. Rational Unified Process: Best Practices for Software Development Teams, December 2003.
- [11] Ivar Jacobson, Grady Booch, and James Rumbaugh. *The Unified Software Development Process*. Addison Wesley, February 1999.
- [12] Luiz Fernando Capretz. Y: A New Component-Based Software Life Cycle Model. *Journal Of Computer Science*, 1:1, 2005.
- [13] B. Nuseibeh. Weaving Together Requirements and Architectures. *Computer*, 34(3):115–119, March 2001.
- [14] Object Management Group, Framingham, Massachusetts. *MDA Guide Version 1.0.1*, June 2003.
- [15] OMG. *UML Profile for MARTE: Modeling and Analysis of Real-Time Embedded Systems v1.0*, November 2009.
- [16] OMG. *Systems Modeling Language Specification v1.2*, July 2010.
- [17] OMG. *Unified Modeling Language Specification 2.3*, April 2010.
- [18] Bernard Rygaert. PDSI: Processus de Développement des Systèmes Industriels, 2002. Marketing flyer from Silicomp.
- [19] Sebastien Gerard. Papyrus Home Page. <http://eclipse.org/papyrus>.
- [20] P.S. Seligmann, GM.M. Wijers, and H.G. Sol. Analyzing the Structure of I.S. Methodologies, an Alternative Approach. In *Proceedings of the First Dutch Conference on Information Systems*, 1989.
- [21] Sébastien Gérard, Cédric Dumoulin nad Patrick Tessier, and Bran Selic. *Papyrus: A UML2 tool for Domain-Specific Language Modeling*, volume 6100. Springer Verlag, 2010.
- [22] J. Vidal, F. de Lamotte, G. Gogniat, P. Soulard, and J.-P. Diguët. A Co-Design Approach for Embedded System Modeling and Code Generation with UML and MARTE. In *Design, Automation Test in Europe Conference Exhibition, 2009. DATE '09*, pages 226–231, April 2009.