



HAL
open science

Comparative Analysis of Ranging Protocols for Localization by UWB in Outdoor

Salick Diagne, Thierry Val, Abdou Karim Farota, Bouya Diop

► **To cite this version:**

Salick Diagne, Thierry Val, Abdou Karim Farota, Bouya Diop. Comparative Analysis of Ranging Protocols for Localization by UWB in Outdoor. *Wireless Sensor Network*, 2018, 10 (5), pp.0. 10.4236/wsn.2018.105006 . hal-02191838

HAL Id: hal-02191838

<https://hal.science/hal-02191838>

Submitted on 23 Jul 2019

HAL is a multi-disciplinary open access archive for the deposit and dissemination of scientific research documents, whether they are published or not. The documents may come from teaching and research institutions in France or abroad, or from public or private research centers.

L'archive ouverte pluridisciplinaire **HAL**, est destinée au dépôt et à la diffusion de documents scientifiques de niveau recherche, publiés ou non, émanant des établissements d'enseignement et de recherche français ou étrangers, des laboratoires publics ou privés.



Open Archive Toulouse Archive Ouverte

OATAO is an open access repository that collects the work of Toulouse researchers and makes it freely available over the web where possible

This is an author's version published in:
<http://oatao.univ-toulouse.fr/22513>

Official URL

DOI : <https://doi.org/10.4236/wsn.2018.105006>

To cite this version: Diagne, Salick and Val, Thierry and Farota, Abdou Karim and Diop, Bouya *Comparative Analysis of Ranging Protocols for Localization by UWB in Outdoor*. (2018) *Wireless Sensor Network*, 10 (5). ISSN 1945-3078

Any correspondence concerning this service should be sent to the repository administrator: tech-oatao@listes-diff.inp-toulouse.fr

Comparative Analysis of Ranging Protocols for Localization by UWB in Outdoor

Salick Diagne¹, Thierry Val², Abdou Karim Farota¹, Bouya Diop¹

¹Laboratoire des Sciences de l'Atmosphère et des Océans, UFR SAT/UGB, Saint-Louis, Sénégal

²Institut de Recherche en Informatique de Toulouse, Université de Toulouse, Blagnac, France

Email: salickdiagne@gmail.com, thierry.val@univ-tlse2.fr, abdou-karim.farota@ugb.edu.sn, bouya.diop@ugb.edu.sn

Abstract

The rapid evolution of technology in the field of wireless telecommunications and micro components using MEMS technologies (Micro-electromechanical systems) has contributed to the expansion and rapid development of wireless sensor networks (WSN). This rapid development has contributed to the appearance of sensor and actuator networks (WSAN) or even to the Internet of Things with DL-IoT (Device Layer-Internet of Things). This rapid evolution of WSN is due to the enthusiasm generated by this last in industry and research. This new technology is used in several applications, particularly in the outdoor location of communicating nodes. The process of distance calculation between nodes (ranging) is a primordial phase for a precise location of these nodes. This paper presents the result of measurements does with three ranging protocols (TWR, TWR_Skew and SDS-TWR) implemented on DecaWiNo nodes. DecaWiNo nodes use the Ultra-Wide Band (UWB) radio links, proposed by the IEEE 802.15.4 standard amendment of the year 2007, which provides a high-performance ranging by ToF (Time of Flight) [1] [2]. The results are very promising with precision errors of the order of 50 cm over 20 meters.

Keywords

Outdoor Location, UWB, Ranging, ToF, TWR, DecaWiNo

1. Introduction

We notice in recent years, agriculture increasingly oriented towards a widespread use of new technologies. We no longer talk about the mechanization of agriculture, but rather a smart agriculture. This type of agriculture uses WSAN technology to improve crop yields, in particular by controlling the humidity

Copyright © 2018 by authors and Scientific Research Publishing Inc. This work is licensed under the Creative Commons Attribution International License (CC BY 4.0).

<http://creativecommons.org/licenses/by/4.0/>



Open Access

level of the plants [3] or for a much more precise irrigation [4]. Its field of application also covers intrusion detection, or more recently the mobile target tracking, especially with military security.

Our goal is to use this technology in mobile target tracking but applied to agriculture for crop protection. This idea was born from an observation made from the destruction of crops in the paddy fields of West Africa, particularly those of Senegal.

Indeed, the destruction of agricultural crops by grain-eating birds has always been a fundamental problem, especially in West Africa. According to [5], these birds, such as quelea, the golden sparrows, village weaver with a strong beak, cause very serious damage that can be estimated each year to several hundred thousand tons. They attack rice, maize, sorghum and wheat by eating the mature and milky grains.

This is how we asked ourselves this fundamental question that guided our approach:

Why not use the advantages offered by this new technology (DL-IoT) to help these farmers to protect their crops without harming the birds?

However, to achieve this, one of the first functions that this network must accomplish is to be able to efficiently locate its own nodes. This first function of our network is also the subject of this document in which we make the comparative study of some protocols of distance calculation between nodes (ranging) by ToF based on the UWB, in order to find the best protocol suited for our application type.

This work emphasizes the metric performances of DecaWiNo nodes in outdoor. In fact, these performances were until then studied in indoor [6], thus this result obtained will complete the DecaWiNos metric study with the main protocols using the ToF for a more general use of these nodes (Indoor and Outdoor).

So, after this introduction, we will first present the most traditional ranging protocols namely TWR, TWR_Skew and SDS-TWR. In the following we will present in Section 3 titled *Outdoor measurements*, the material used for measurements in particular the DecaWiNos nodes, the procedures and measurement results of the various protocols as well as their interpretation. Then in Section 4, we will discuss the results obtained. And finally, the conclusion will allow us to emphasize the possibilities of using our results as well as the research perspectives arising from this work.

2. The Ranging Protocols

For most sensor and actuator network applications, the event detected by a node is useful only if the information about its geographical location is provided. For this, the network needs to locate its nodes. So many algorithms and localization techniques in outdoor have been developed. These algorithms and localization techniques use a variety of communication technologies, offering to users adapted location systems according to the criteria required by the different

DL-IoT type applications. These criteria are often the range of communication, the transmission rate or the energy consumption. Technologies such as infrared, Bluetooth, Zigbee or UWB are used in this sense by localization systems.

The most frequent localization techniques in literature can be classified into two groups: Range-Free localization and Range-Based localization.

The Range-Free technique, like those of the DV-Hop family, is based on topology and connectivity information, assuming an isotropic network where the number of jumps between the nodes is proportional to their distance. But this solution is not very accurate (because of the malfunctions and the not guaranteed network connectivity).

The Range-Based localization, uses the distance (or angle) measured between two nodes (Ranging) to determine the position of a node.

There are several techniques to measure the distance (or angle) between two nodes: The Time of Flight (ToF), the Time Difference of Arrival (TDoA), the Angle of Arrival (AoA), and the Received Signal Strength Indicator (RSSI).

In ToF or ToA (Time of Arrival), we exploit the relationship between distance travelled by the signal and the time taken. For this technique, synchronization between transmitter and receiver is often required.

The TDoA uses the same principle as ToA with some differences to measure the distance between two close nodes. It uses the time difference taken by two signals sent by the same node and whose propagation speed is different. In general, we use ultrasound ($V \simeq 340$ m/s in air at 15°C) or sound waves ($C \simeq 3.10^8$ m/s) to have this difference. This technique has drawbacks related to the energy consumption (because of the two signals emitted), the short range and its limited use in outdoor due to ultrasound for example.

The technique based on the AoA allows the location of a node by measuring the arrival angle of a signal. In this technique, the nodes measuring the angle are equipped with small antennas or ultrasonic receiver. The receiving node uses the arrival time or signal phase to calculate the arrival angle.

These ultrasonic antennas and receivers (imposing small distances between receiving nodes) constitute the major disadvantage in terms of cost and size for this method.

Finally, for the RSSI technique that uses the physical characteristic of the radio channel (the RSSI signal strength). In theory more the distance between two nodes increases more the signal is attenuated (the RSSI power indicator decreases). Thus, it is possible for a receiving node to calculate the distance that separates it from a transmitting node based on the power of the received signal. This method has an advantage over the cost since the nodes are already equipped with RF devices. But it is not very precise compared to other methods. Because of its sensitivity to noise, interference, asymmetry of the communication link (no-conformity of the RSSI), obstacles and types of antennas capable caused errors exceeding 50% of the range of the communication device [7].

Although requiring a perfect synchronism of the transmitting and receiving

nodes, the technique based on the ToF is much more precise than the other techniques especially with the use of the UWB technology (ensuring an acceptable synchronization).

Thus, several works propose methods of distance calculation between nodes (Ranging) based on the ToF. These methods of calculation often called Ranging protocols are presented in the following sections.

2.1. TWR (To Way Ranging)

This is the simplest protocol using two-node messages and taking the clock from one of the nodes as a reference. Because most of the time, nodes in communication are often asynchronous. The TWR protocol is based on a set of three messages, two of which, (START and ACK) necessary for stamping and obtaining time-of-flight measurement information (Figure 1).

In this protocol, the node A, initiator of the exchange sends its first frame (START) and marks its time of emission t_1 . On receipt of this frame, the node B in turn marks the reception time t_2 of this frame and after a certain time sends an acknowledgment frame (ACK) while marking its sending time t_3 . The node A, on receipt of the ACK frame, marks the reception time t_4 . The four time stamps are collected on the node A side after receiving the DATA_REPLY frame containing the tags t_2 and t_3 of the node B. This last frame will allow node A to calculate the flight time noted in Equation (1) and distance in Equation (2).

$$\text{ToF}_{\text{TWR}} = \frac{(t_4 - t_1) - (t_3 - t_2)}{2} \quad (1)$$

$$\text{Distance} = \text{ToF}_{\text{TWR}} * C, \text{ with } C \approx 3.10^8 \quad (2)$$

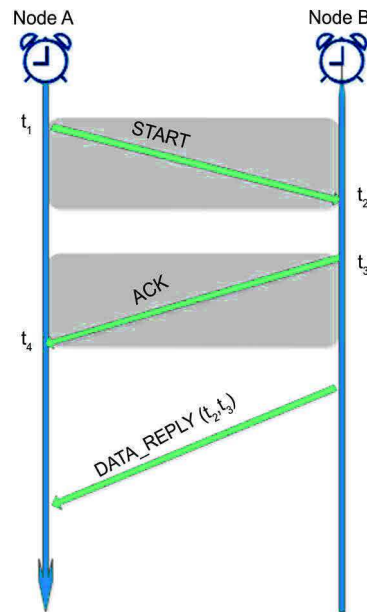

Figure 1. TWR protocol performing ToF measurement between two “asynchronous” nodes.

The principal disadvantage of this protocol is the drift of the clocks which causes temporal imprecision. Indeed, the two clocks of the nodes A and B are not based on the same quartz, they cannot be perfectly synchronous. Thus, an overestimation or underestimation of the measurement of the flight time could lead to an absurd location of the nodes.

2.2. TWR_Skew

The TWR_Skew is a protocol based on the simple TWR, it is presented in [8]. Its objective was to evaluate the impact of TWR ranging accuracy in normal traffic by introducing a variable artificial delay in order to compensate for imprecision due to delay. This delay introduced between the messages START and ACK actually represents the delay introduced by the usual traffic especially the method of access to the medium.

The authors of [8] propose a correction of the introduced error, based on the parameter k which represents the ratio of the frequency f_B of the clock of the node B and the frequency f_A of the clock of the node A. By introducing this parameter k into Equation (1), this results in a new general ToF equation:

$$\text{ToF}_{\text{TWR_Skew}} = \frac{t_4 - t_1 - k(t_3 - t_2)}{2}, \text{ with } k \approx 1 \quad (3)$$

The communication modules that we use with DecaWiNo and also used in [8] offer functionality, the Clock Offset evaluating the difference in frequency between the two clocks. This difference called Skew is the origin of the name of this protocol.

It is affirmed in [8] that this correction makes it possible to correct both the drift errors introduced by the temperature variations and those due to delays between messages (Figure 2).

2.3. The SDS-TWR Protocol (Symmetrical Double-Side Two-Way Ranging)

In order to reduce or eliminate the error introduced by the clock drift, another protocol symmetries the ranging session by adding an additional message to the classical session of the TWR protocol: this is the SDS-TWR protocol.

1) The Double-sided component: The protocol is based on two symmetrical sessions of the TWR protocol (TWR_{A-B} and TWR_{B-A}).

$$\text{TWR}_{A-B} : \text{ToF}_{A-B} = \frac{(t_4 - t_1) - (t_3 - t_2)}{2} \quad (4)$$

$$\text{TWR}_{B-A} : \text{ToF}_{B-A} = \frac{(t_6 - t_3) - (t_5 - t_4)}{2} \quad (5)$$

2) The Symmetrical component: the response time between the two nodes is assumed to be identical ($T_{R-A} = T_{R-B}$, with $T_R = \text{Response Time}$) (Figure 3).

Each node marks its own transmit and receive stamps. All the timestamps will be collected on the side of the node A after the reception of the DATA_REPLY

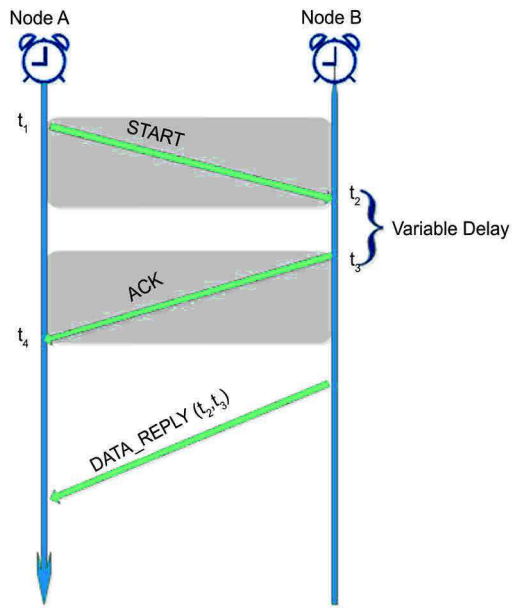

Figure 2. Ranging protocol session TWR_Skew.

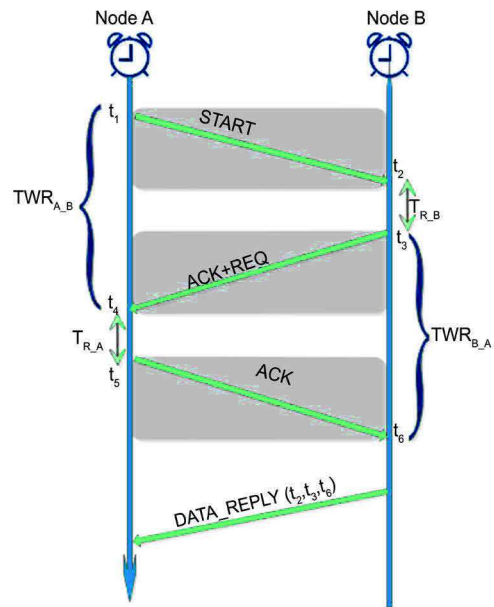

Figure 3. SDS-TWR protocol performing ToF measurement between two “asynchronous” nodes.

message containing the instants t_2 , t_3 and t_6 of the node B. Calculations of flight time and distance are obtained by using Equation (6) and Equation (7).

$$\text{ToF}_{\text{SDS-TWR}} = \frac{(t_4 - t_1) - (t_3 - t_2) + (t_6 - t_3) - (t_5 - t_4)}{4} \quad (6)$$

$$\text{Distance} = \text{ToF}_{\text{SDS-TWR}} * C \quad (7)$$

Because of the frequency shift at the nodes, the return times for the response of A and B are evaluated differently. An average of two “round trip” times of A

and B will allow reducing the error induced ranging. This specificity of the protocol will therefore reduce the difference between the actual distance and that which will be measured by the SDSTWR protocol without completely eliminating it [8].

3. Outdoor Measurements

Often, simple analyses based on simulation software are enough to provide a result on the performance of a given system. However, these programs are based on too idealistic models that do not often consider the imperfections and physical realities of the material and the measurement environment.

When the system to be studied is a WSN, the fact that these parameters are not considered may lead to a different operation from the deployment than that provided by the simulation software.

Thus, certainly, the best approach would be to perform analyses on real nodes (sensors and actuators) and in a real physical environment. This explains why our analysis approach is based on measurements with real nodes.

3.1. Description of Measurement Equipment

For the measurements, we use two DecaWiNo nodes: the first fixed and located at a height of 1.5 m from the ground, the second always at the same height is linked to a mobile pole. The pole here serves only to vary the distance between our two nodes. See **Figure 4**.

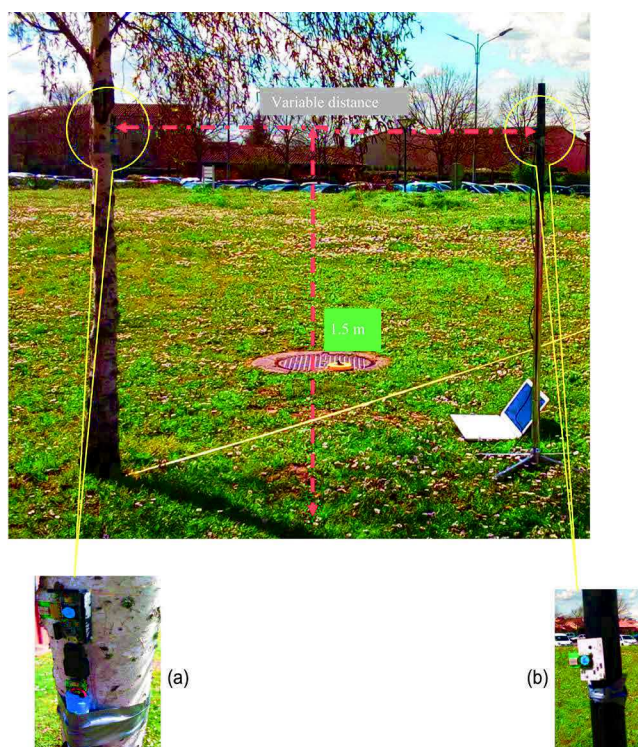

Figure 4. Principle of taking measurements. (a) Fixed DecaWiNo; (b) DecaWiNo carried by the mobile pole.

3.1.1. DecaWiNo Node

DecaWiNo is part of the family of WiNo nodes (Wireless Node) [9] developed at IRIT by the RMESS team. The WiNo family is based on the Arduino environment and its components are developed in Open Hardware, allowing to setting up a wide variety of WiNos (see Figure 5). Table 1 summarizes the principal features of the developed WiNo nodes.

As we said earlier in this study, we will use DecaWiNo. This type of WiNo is composed of an Arduino board (Teensy 3.2) and the DecaWave DWM 1000 module with a UWB transceiver and an antenna. For node management, the DecaDuino library was developed by the RMESS team in the Arduino environment (Figure 6).

3.2. Measurement Procedures

For each of the three protocols, we carried out measurements on 19 points, and on each point 100 measurements were collected which makes a total of 5700 measurements.

Measurements are made in external environment, considering the two nodes in line of sight (LOS) and always starting for each protocol with a taking at 0.5 m.

After this, we start from 1 m to 5 m in steps of 1 m. Then 5 m to 30 m in steps of 2 m and always pass by the point 20 m.

3.3. Measurement Results

We present in the following sections the results obtained with the various protocols mentioned as well as their graphical representation.

3.3.1. Ranging by TWR Simple

We summarize in Table 2 the measurements made with the TWR protocol. However, with the number of takes made: 100 for each point, we will only give

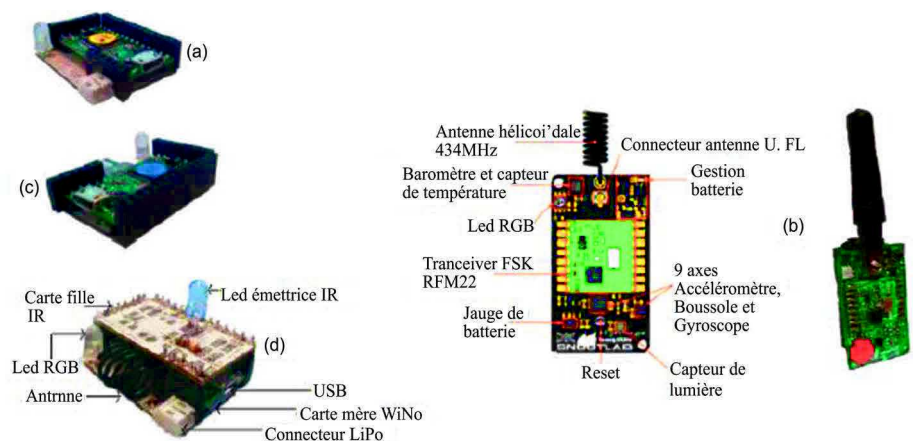

Figure 5. The WiNos nodes. (a) WiNoRF22; (b) TeensyWiNo; (c) DecaWiNo and (d) WiNoIR.

Table 1. Characteristics of WiNos developed [8].

	WiNoRF22	TeensyWiNo	DecaWino	WiNoVW	WiNoLoRa	WiNoIR
CPU/RAM/Flash	ARM Cortex M4 (32 bits) 72 MHz, 64 kB RAM, 256 Kb Flash (PJRC Teensy 3.1)					
Transceiver	HopeRF RFM22b: 200 - 900 MHz, 1 - 125 kbps, GFSK/FSK/OOK, +20 dBm		DWM 1000: UWB IEEE 802.15.4	Variés	RFM95	RF22 + Diodes IR
Librairie	RadioHead		DecaDuino	VirtualWire	RadioHead	IrRemote
Capteurs	Température, Luminosité	Température, Luminosité, Baromètre, Magnétomètre, Accéléromètre, Gyromètre		Température, Luminosité		
Usage	WSN, IoT		IoT avec Ranging, localisation en intérieur, courte portée	Communication très bas débit sur médiums non conventionnels	Longue portée, très bas débit	
Disponibilité	DIY	snootlab.com	DIY (Do It Yourself, à assembler soi-même)			

Table 2. Summary of TWR measures (m).

Real Distance	Average distance TWR	Average error	Minimum Error	Maximum error
0.5	0.65	0.15	0.07	0.19
1	1.19	0.19	0.15	0.23
2	2.1591	0.1591	0.12	0.19
3	3.14	0.14	0.09	0.2
4	4.12	0.12	0.06	0.16
5	5.20	0.20	0.16	0.25
7	7.04	0.04	-0.01	0.07
9	9.00	-0.00	-0.05	0.03
11	10.9481	-0.05	-0.1	0.03
13	12.87	-0.13	-0.19	-0.08
15	14.72	-0.28	-0.33	-0.23
17	16.62	-0.38	-0.43	-0.32
19	18.47	-0.53	-0.57	-0.48
20	19.49	-0.51	-0.56	-0.46
22	21.48	-0.52	-0.56	-0.48
24	23.33	-0.67	-0.74	-0.58
26	25.21	-0.79	-0.84	-0.71
28	27.08	-0.92	-0.98	-0.86
30	28.89	-1.11	-1.18	-1.05

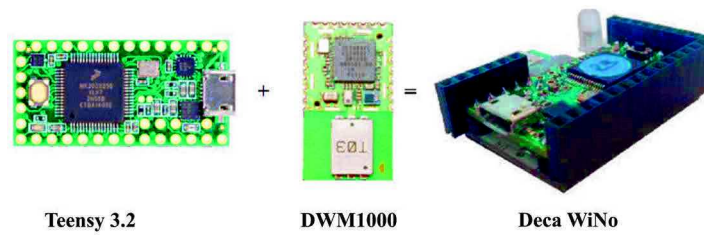

Figure 6. Components of DecaWiNo.

the average value measured by the TWR protocol for each point as well as the average, minimum and maximum errors.

The representation of the error according to the real distance (**Figure 7**) shows in a general way that the absolute average error varies from 0 to 1.10 m with extremums ranging from 1 cm to 1.18 m over a real distance of 0.5 to 30 m. In particular, for real distances with less than 14 m, the average error does not exceed 20 cm and the maximum error is 25 cm. These average and maximum absolute errors are around 50 cm over distances between 14 and 22 meters. And for distances between 22 and 30 meters, these values are around 60 centimetres for the average value and 58 to 98 centimetres for the extremums. And finally, we find that the error committed by the TWR is greater than 1 meter for the real distances greater than or equal to 30 meters.

We also notice that for distances of less than 9 meters, the TWR overestimates the actual distance.

3.3.2. Ranging by TWR_Skew

Under the same conditions and measurement parameters as those of the TWR, we performed measurements with the TWR_Skew protocol. The results are summarized in **Table 3** and graphically represented in **Figure 8**.

We note here that the average error varies generally from 20 cm to 1.5 m with absolute extreme values ranging from 37 cm to 1.63 m over real distances from 0.5 to 30 meters.

In particular, it can be seen on the one hand that for real distances of less than 13 meters the absolute errors (means and extremums) do not exceed 50 cm. And on the other hand, that the absolute average error evolves rapidly from 50 cm to 1.50 m with absolute extremums of 60 cm to 1.63 m over distances between 13 and 30 meters.

We can also notice that with the TWR_Skew protocol, the actual distances are in general underestimates.

3.3.3. Ranging by SDS_TWR

Still in the same conditions as previously experiments with TWR and TWR_Skew protocols, we performed measurements with the SDS_TWR protocol. The results obtained are recorded in **Table 4** and represented in **Figure 9**.

The average absolute error varies here from 20 cm to 1.30 m with extremums of 17 cm to 1.43 m over distances of 0.5 to 30 meters.

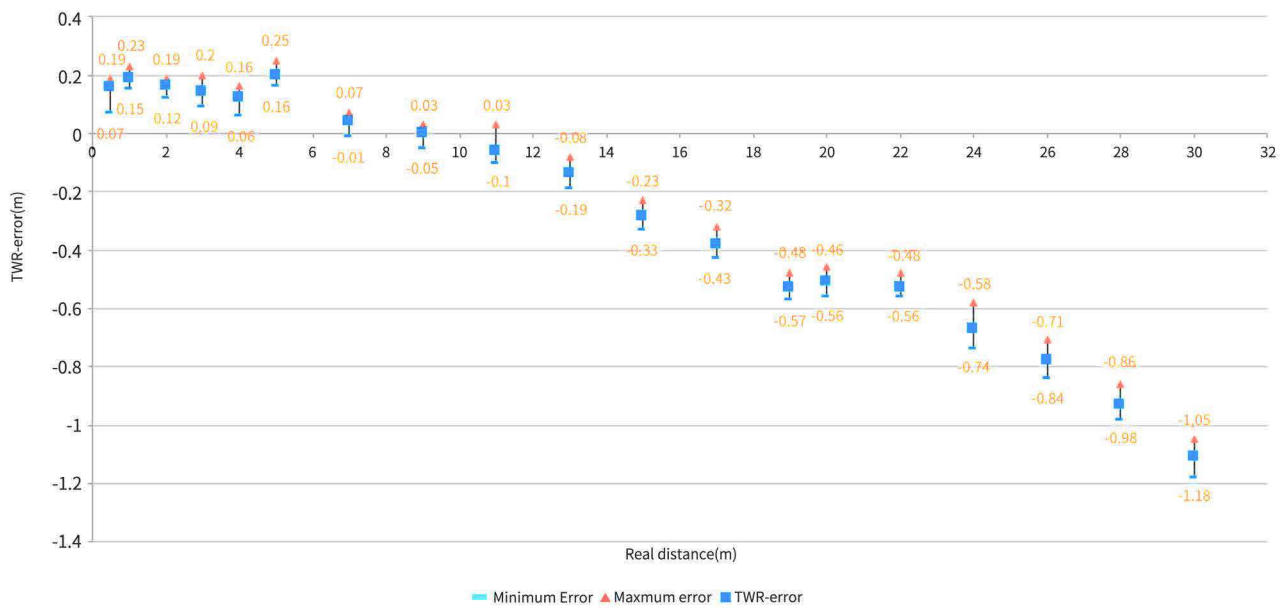

Figure 7. Representation of the TWR error depending the distance.

Table 3. Summary of TWR_Skew Measures (m).

Real Distance	Average distance TWR	Average error	Minimum Error	Maximum error
0.5	0.26	-0.24	-0.31	-0.19
1	0.80	-0.20	-0.28	-0.13
2	1.7757	-0.2243	-0.34	-0.15
3	2.77	-0.23	-0.37	-0.12
4	3.76	-0.24	-0.33	-0.13
5	4.83	-0.17	-0.26	-0.1
7	6.66	-0.34	-0.43	-0.26
9	8.61	-0.39	-0.50	-0.30
11	10.6028	-0.40	-0.48	-0.31
13	12.48	-0.52	-0.60	-0.44
15	14.32	-0.68	-0.80	-0.59
17	16.26	-0.74	-0.86	-0.63
19	18.09	-0.91	-0.99	-0.78
20	19.11	-0.89	-1.00	-0.81
22	21.09	-0.91	-1.03	-0.83
24	22.94	-1.06	-1.23	-0.92
26	24.83	-1.17	-1.26	-1.07
28	28.50	-1.32	-1.46	-1.18
30	28.50	-1.50	-1.63	-1.36

As for the TWR_Skew, we also note that for distances less than 13 meters the absolute errors (means and extremums) do not exceed 50 cm. Beyond 13 meters,

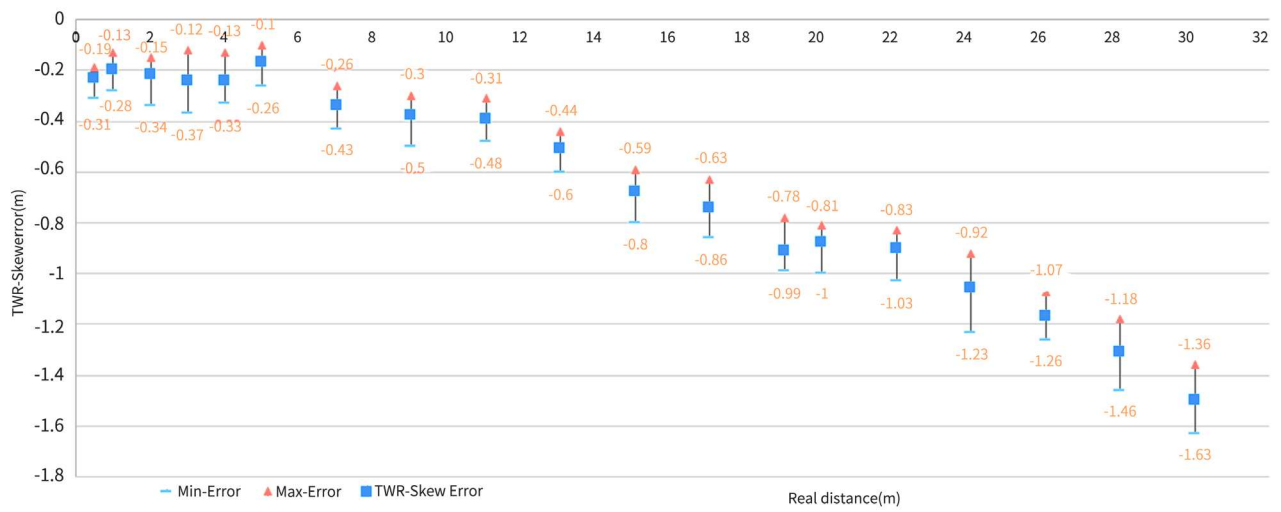

Figure 8. Representation of TWR Skew error depending on the distance.

Table 4. Summary of SDS-TWR measurements (m).

Real Distance	Average distance TWR	Average error	Minimum error	Maximum error
0.5	0.29	-0.21	-0.25	-0.17
1	0.76	-0.24	-0.27	-0.21
2	1.7743	-0.2257	-0.26	-0.19
3	2.76	-0.24	-0.28	-0.19
4	3.74	-0.26	-0.3	-0.21
5	4.67	-0.33	-0.36	-0.3
7	6.64	-0.36	-0.39	-0.33
9	8.57	-0.43	-0.47	-0.39
11	10.5078	-0.49	-0.56	-0.38
13	12.43	-0.57	-0.62	-0.53
15	14.32	-0.68	-0.71	-0.64
17	16.22	-0.78	-0.82	-0.73
19	18.11	-0.89	-0.92	-0.86
20	19.09	-0.91	-0.94	-0.85
22	20.94	-1.06	-1.10	-1.03
24	-22.97	-1.04	-1.15	-0.87
26	24.68	-1.32	-1.43	-1.21
28	28.63	-1.25	-1.30	-1.19
30	28.63	-1.37	-1.42	-1.31

these absolute average errors evolve rapidly from 55 cm for a real distance of 13 meters to 1.35 m for a real distance of 30 meters, with extremums ranging from 53 cm to 1.43 m respectively. The SDS-TWR protocol always gives an underestimated value of the real distance.

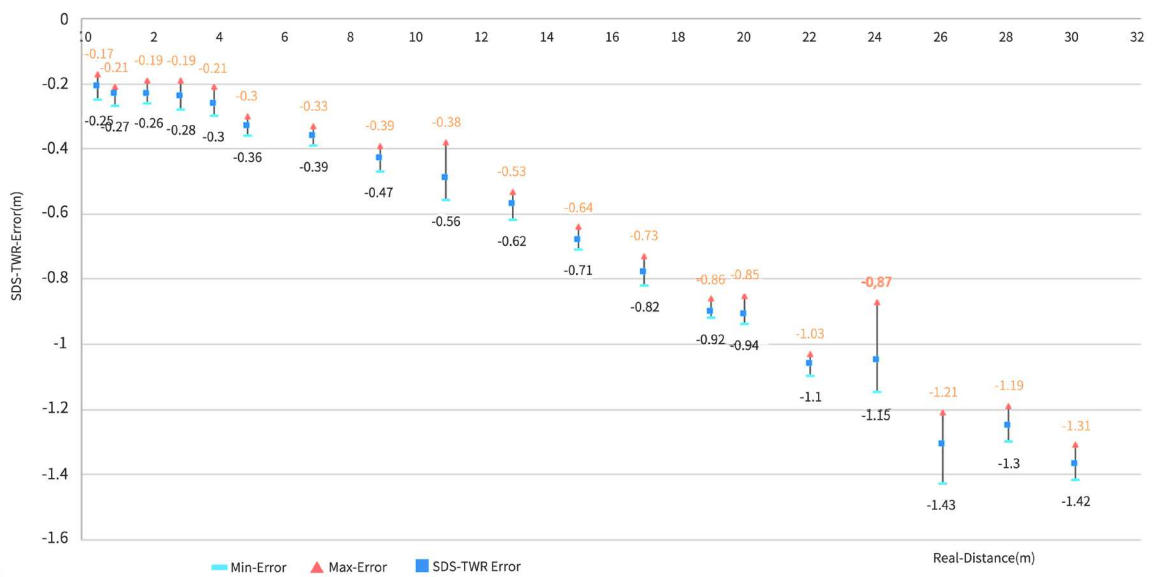

Figure 9. Representation of SDS_TWR error depending on the distance.

3.4. Discussion

The observation of the average errors shows that the errors made by the TWR_Skew and SDS_TWR protocols are quite close. Even though the TWR_Skew error is slightly smaller for distances less than 28 meters, the error committed by these two protocols exceeds 50 cm for the real distances greater than 13 meters.

On the other hand, for the TWR protocol, the error made here is much smaller, going up to an absolute distance of 50 cm from that made by the TWR_Skew protocol. In addition, for this protocol, the error does not exceed 50 cm for distances less than or equal to 22 meters (see [Figure 10](#)). This result obtained with the TWR protocol seems very interesting especially for applications where the distance between the nodes does not exceed 22 meters and a precision of the order of 20 cm (for distances less than 14 meters) or 50 cm maximum (for distances between 14 and 22 meters).

Thus, given the number of measurements taken per point, we can say that comparatively the TWR ranging protocol is better than the TWR_Skew and SDS_TWR ranging protocols in outdoor; even though these last two protocols have been established to correct the mistakes of TWR. But the validation tests of the correction of TWR errors by the TWR_Skew and SDS_TWR have been done until then in indoor environment with a lot of reflections because of the walls and ceiling, and low ranges not exceeding 10 meters.

4. Conclusion

In this paper, we have implemented three ToF ranging protocols (TWR, TWR_Skew and SDS-TWR) on DecaWiNo nodes incorporating UWB technology. These nodes allowed us to make ranging measurements whose graphical



Figure 10. Error representation of different protocols depending on the real distance.

interpretation allowed to showing the individual performances of the various protocols.

These performances offer us several perspectives, first of all on the integration of the TWR protocol on our application whose maximum distance between nodes is 20 meters; since this protocol is the one that better estimates the distance between nodes among the three studied in this document. But also, perspectives on the search for mechanisms that can help reduce the error committed by the TWR protocol, as well as the study of the impact of the error made by this protocol on the accuracy of mobile target location algorithms.

Acknowledgements

The authors would like to thank CEA-MITIC of the UFR SAT at the University Gaston Berger of Saint-Louis/Senegal for his financial support for the travel to Toulouse (in France) and the publication of this work.

Conflicts of Interest

The authors declare no conflicts of interest regarding the publication of this paper.

References

- [1] Kobenan IgnaceKossonou (2014) Étude d'un système de localisation 3-D haute précision basé sur les techniques de transmission Ultra Large Bande à basse consommation d'énergie pour les objets mobiles communicants. Electronique Université de Valenciennes et du Hainaut-Cambrésis, Valenciennes.
- [2] Fofana, N.I., Van Bossche, A. and Val, T. (2014) Etude des couches MAC dédiées à l'UWB. Journées Nationales des Communications Terrestres-JNCT 2014, Toulouse, France, 8-19.
- [3] Jacquot, A., De Sousa, G., Chanet, J.P. and Pinet, F. (2011) Réseau de capteurs sans fil pour le suivi de l'humidité du sol des vignes. ECOTECHS' 2011, Capteurs et systèmes de mesures pour les applications environnementales. Montoldre, France.

- [4] LópezRiquelme, J.A., Soto, F., Suardíaz, J., Sánchez, P., Iborra, A. and Vera, J.A. (2009) Wireless Sensor Networks for Precision Horticulture in Southern Spain. *Computers and Electronics in Agriculture*, **68**, 25-35. <https://doi.org/10.1016/j.compag.2009.04.006>
- [5] Mallamaire, L. (1961) La lutte contre les oiseaux granivores en Afrique Occidentale (Mauritanie, Sénégal, Soudan, Niger). *Journal d'Agriculture Tropicale et de Botanique Appliquée*, **8**, 141-179. <https://doi.org/10.3406/jatba.1961.6911>
- [6] Fofana, Nezo Ibrahim, Van den Bossche, Adrien, Dalce, Rejane and Val (2016) Thierry Prototypage et analyse de performances d'un système de ranging pour une localisation par UWB. 16^{ème} Colloque Francophone sur l'Ingénierie des Protocoles (CFIP 2015), Paris, France, 22-24 July 2015, 1-8.
- [7] Kara, M. (2009) Réseau de capteurs sans fil: étude en vue de la réalisation d'un récepteur GPS différentiel à faible coût. Réseaux et télécommunications [cs. NI]. Université Blaise Pascal-Clermont-Ferrand II, Clermont-Ferrand.
- [8] Ibrahim, F.N. (2017) Contribution aux architectures protocolaires pour un système de localisation dans un réseau de capteurs sans fil basé sur une couche physique 802.14.4a UWB. Université Toulouse Jean-Jaurès, Juillet.
- [9] <http://wino.cc//decawino>