



HAL
open science

NAFID - A Grid Tool for output only modal analysis

Viet-Hung Vu

► **To cite this version:**

Viet-Hung Vu. NAFID - A Grid Tool for output only modal analysis. Surveillance, Vishno and AVE conferences, INSA-Lyon, Université de Lyon, Jul 2019, Lyon, France. pp.119-127. <hal-02190263>

HAL Id: hal-02190263

<https://hal.science/hal-02190263v1>

Submitted on 22 Jul 2019

HAL is a multi-disciplinary open access archive for the deposit and dissemination of scientific research documents, whether they are published or not. The documents may come from teaching and research institutions in France or abroad, or from public or private research centers.

L'archive ouverte pluridisciplinaire HAL, est destinée au dépôt et à la diffusion de documents scientifiques de niveau recherche, publiés ou non, émanant des établissements d'enseignement et de recherche français ou étrangers, des laboratoires publics ou privés.



HAL Authorization

NAFID - A Grid Tool for output only modal analysis

Thanh-Trung DO, Viet-Hung VU, Zhaoheng LIU

Department of Mechanical Engineering
École de technologie supérieure, Montreal, QC, Canada
thanh-trung.do.1@ens.etsmtl.ca, viet-hung.vu@etsmtl.ca, zhaoheng.liu@etsmtl.ca

Abstract

In this paper, we propose a technique to enhance and facilitate the output only modal analysis of systems and structures by using the vector autoregressive (VAR) model. As we have witnessed, the VAR model with its robustness, accuracy, and noise - excitation resistance is beneficial for output only modal analysis. However, the VAR model and other parameters models have to deal with the variation of the model orders such as the frequency stabilization diagram. A grid technique is introduced to classify the natural frequencies and damping ratios in order to automatically evaluate its stabilization. The combination of the grid technique and the stabilization diagram will allow to users to have a better perspective of the modal parameters and a more accurate modes. The method is implemented and built in Matlab as the NAFID-tool which is users friendly and interactive. Examples on simulations of a MDOF system and on a real structure the applicability of the technique are illustrated to prove the efficiency of this technique.

1 Introduction

Natural frequencies, damping ratios and mode shapes, called modal parameters, are three important properties of mechanical systems and structures. Together with mathematical model, they allows us to analyze and predict dynamic behavior of systems under external excitations. For a mechanical system with several degrees of freedom, analytical model derived based on dynamic principles can be used to compute these parameters. However, for complex systems, modal parameters can be obtained using experiments. Although the Finite Element method (FEM) can be used for this purpose, however, as pointed out in [4], modal parameters for real-systems estimated by FEM is not accurate enough.

In practice, the well-known technique, called experimental modal analysis (EMA), is often used for this purpose [5]. By using the EMA technique, both excitation forces (input) and response (output) are used to identify modal parameters. In many situations, the excitation forces are unknown or cannot be measured. This leads to another technique for modal parameter identification, called operational modal analysis (OMA) [2]. In the OMA method, the modal parameters are extracted from the measured response and the excitation forces are modeled as white noise with zero mean.

The time domain has been found to be more suitable for the OMA method [7]. The AR model for single output and the VAR model for multi output can be used to estimate modal parameters from the measured response. The VAR model is proved very robust to identify natural frequencies even it can detect closed modes. This is because response of the system is measured simultaneously by many sensors.

When using VAR model, the selection of model order is the crucial because the size of the state matrix used to compute frequencies increases when the model order increases. The criteria proposed in [3] may be used for this purpose. In [9], a new method based on the concept of optimal model order was proposed for automatically classifying the modes and identifying the modal parameters.

In this study, the grid techniques is proposed to identify natural frequencies and damping ratios using measured response only without excitation forces. Basically, the method is developed based on the vector autoregressive (VAR) model in which the parameter model is obtained using multivariate least-square method. From the stabilization diagram, stable modal parameters are detected using the grid technique. Based on the proposed method, a new program, called NAFID-tool, has been implemented in Matlab. This tool can be used to identify modal parameters

This paper is organized as follows. In Section 2, the VAR model is presented in order to establish the state matrix and to compute modal parameters. In Section 3, the grid technique is addressed for identifying stable frequencies and damping ratios. Modal parameter identification of some mechanical systems is presented in Section 4. Finally, conclusions are given in Section 5.

2 Theoretical background

2.1 Vector autoregressive model

In the case of operational modal analysis (OMA), we assume that the excitation is unknown and may be modeled by Gaussian white noise. Using m sensors, output response of a mechanical system is measured at m predefined locations with constant sampling time Δt . The measured output data including n data points can be expressed by the following matrix

$$Y = \begin{bmatrix} y_{1,1} & y_{1,2} & y_{1,3} & \cdots & y_{1,n} \\ y_{2,1} & y_{2,2} & y_{2,3} & \cdots & y_{2,n} \\ \vdots & \vdots & \vdots & \cdots & \vdots \\ y_{m,1} & y_{m,2} & y_{m,3} & \cdots & y_{m,n} \end{bmatrix} = [y_{[1]}, y_{[2]}, y_{[3]}, \dots, y_{[n]}] \quad \text{where } y_{[i]} = \begin{bmatrix} y_{1,i} \\ y_{2,i} \\ \vdots \\ y_{m,i} \end{bmatrix} \quad (1)$$

where $Y \in \mathbb{R}^{m \times n}$ is called as data matrix with $n \gg m$ and $y_{[i]} \in \mathbb{R}^{m \times 1}$ is the column i of Y , for $i = 1, \dots, n$.

Based on the vector autoregressive model of order p , denoted by VAR(p), as presented in [7, 1, 10], dynamical model of the considered mechanical system may be expressed as

$$y_{[t+k]} = A_1 y_{[t+k-1]} + A_2 y_{[t+k-2]} + \cdots + A_p y_{[t+k-p]} + e_k \quad (2)$$

or equivalence to

$$y_{[t+k]} = [A_1, A_2, \dots, A_p] \begin{bmatrix} y_{[t+k-1]} \\ y_{[t+k-2]} \\ \vdots \\ y_{[t+k-p]} \end{bmatrix} + e_k \quad (3)$$

where $A_j \in \mathbb{R}^{m \times m}$ for $j = 1, \dots, p$ are the autoregressive matrices, $y_{[t+k]}, y_{[t+k-j]} \in \mathbb{R}^{m \times 1}$ are vectors of the current and past response, respectively, and $e_k \in \mathbb{R}^{m \times 1}$ is a residual vector.

2.2 Evaluating parameter matrix

If we consider N consecutive values of the responses, Eq. (3) may be expanded for $k = 0, \dots, N$. Therefore, the relationship between the current response and the previous (past) response is written in compact form as

$$B = \Phi_A R + E \quad (4)$$

where $B \in \mathbb{R}^{m \times N}$ is the matrix of N responses, $\Phi_A \in \mathbb{R}^{m \times pm}$ is the parameter matrix of the system, $R \in \mathbb{R}^{pm \times N}$ is the regression matrix of the output, and $E \in \mathbb{R}^{m \times N}$ is the model error matrix of the system. These matrices are defined as

$$B = [y_{[t]}, y_{[t+1]}, \dots, y_{[t+N]}] \quad (5)$$

$$\Phi_A = [A_1, A_2, \dots, A_p] \quad (6)$$

$$E = [e_0, e_1, \dots, e_N] \quad (7)$$

$$R = \begin{bmatrix} y_{[t-1]} & y_{[t]} & \cdots & y_{[t+N-1]} \\ y_{[t-2]} & y_{[t-1]} & \cdots & y_{[t+N-2]} \\ \vdots & \vdots & \vdots & \vdots \\ y_{[t-p]} & y_{[t+1-p]} & \cdots & y_{[t+N-p]} \end{bmatrix} \quad (8)$$

From Eq. (4), the parameter matrix Φ_A may be obtained using the multivariate least-square method. This task is equivalent to compute the right pseudo-inverse of R as [5]

$$\Phi_A = BR^T (RR^T)^{-1} \quad (9)$$

In order to avoid computing the inverse matrix, solution of the linear least-square problem can be obtained using the robust techniques such as QR factorization, singular value decomposition (SVD), and LU factorization. For example in [8], the authors proposed the use of QR factorization to derive the parameter matrix.

2.3 Modal parameters

Once the parameter matrix Φ_A is determined, the state matrix of the discrete system, denoted by $\Phi \in \mathbb{R}^{pm \times pm}$, is established as [7]

$$\Phi = \begin{bmatrix} A_1 & A_2 & \dots & A_{p-1} & A_p \\ I & 0 & \dots & 0 & 0 \\ 0 & I & \dots & 0 & 0 \\ \vdots & \vdots & \ddots & \vdots & \vdots \\ 0 & 0 & \dots & I & 0 \end{bmatrix} \quad (10)$$

where $I \in \mathbb{R}^{m \times m}$ is the identity matrix. Because the state matrix represents the dynamics of the real system, it can be used to find natural frequencies and damping ratios. Assume that Φ can be decomposed as: $\Phi = VUV^{-1}$ where $U \in \mathbb{R}^{pm \times pm}$ is the diagonal matrix of eigenvalues and $V \in \mathbb{R}^{pm \times pm}$ is the matrix of eigenvectors. In Matlab, the matrix V and U can be found using the following function: $[V, U] = \text{eig}(\Phi)$. Consequently, each complex eigenvalue $U_{r,r}$ of the discrete system corresponds to one eigenvalue λ_r of the mechanical system

$$\lambda_r = \frac{\ln(U_{r,r})}{\Delta t} \quad (11)$$

Therefore, natural frequency ω_r (rad/s) or f_r (Hz) and damping ratio ζ_r are computed from complex conjugate pairs of λ_r as follows

$$\omega_r = \sqrt{(\text{real}(\lambda_r))^2 + (\text{imag}(\lambda_r))^2} \text{ (rad/s)} \Rightarrow f_r = \frac{\omega_r}{2\pi} \text{ (Hz)} \quad (12)$$

$$\zeta_r = -\frac{\text{real}(\lambda_r)}{\omega_r} \quad (13)$$

When the model order p increases, there are more computational frequencies and damping ratios to be found from Eq. (10) to Eq. (13). That leads to more difficulty in classifying and identifying natural frequencies. The relationship between model orders and frequencies/damping ratios is described by the stabilization diagram. Stable frequencies/damping ratios corresponding to 'real' natural frequencies/damping ratios of the mechanical systems can be identified from this diagram. Other frequencies and damping ratios are unstable. They are due to the error of the identification model or measured data.

3 Modal parameter identifications using grid techniques

In this section, the grid technique is proposed to identify natural frequencies and damping ratios using the VAR model presented in the previous section. In addition, based on this technique, a new tool, called NAFID-tool (natural frequency identification), was successfully implemented in Matlab in order to identify stable frequencies and damping ratios from stabilization diagrams.

3.1 Grid technique

Assume that for each model order p , there are n_p natural frequencies (Hz), denoted by a vector $f^{(p)} \in \mathbb{R}^{1 \times n_p}$ and n_p damping ratios (%), denoted by a vector $\zeta^{(p)} \in \mathbb{R}^{1 \times n_p}$, to be found using Eq. (10) to Eq. (13) as.

$$f^{(p)} = [f_1^{(p)}, f_2^{(p)}, \dots, f_{n_p}^{(p)}] \quad (14)$$

$$\zeta^{(p)} = [\zeta_1^{(p)}, \zeta_2^{(p)}, \dots, \zeta_{n_p}^{(p)}] \quad (15)$$

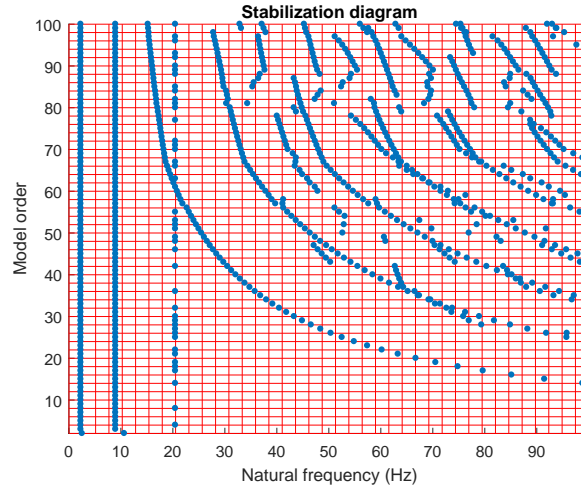

Figure 1 – Illustration of the grid technique.

When the model order varies in the interval $[p_1, p_2, \dots, p_m]$ the number of frequencies/damping ratios is $[n_{p_1}, n_{p_2}, \dots, n_{p_m}]$ in which $n_{p_1} < n_{p_2} < \dots < n_{p_m}$. In the proposed grid technique, whole frequencies and damping ratios of the system for the model order from p_1 to p_m are stored in two special matrices (called cell arrays in Matlab) as follows

$$F = \begin{bmatrix} f^{(p_1)} \\ f^{(p_2)} \\ \vdots \\ f^{(p_m)} \end{bmatrix}, \quad Z = \begin{bmatrix} \zeta^{(p_1)} \\ \zeta^{(p_2)} \\ \vdots \\ \zeta^{(p_m)} \end{bmatrix} \quad (16)$$

where F and Z are the frequency matrix and damping-ratio matrix of the system, respectively. Based on these matrices, stabilization diagrams can plot easily. The grid algorithm proposed here allows us to identify stable frequencies and damping ratios from the stabilization diagrams. Basically, the proposed method includes seven steps as follows:

Step 1 Define the model order range $[p_1, p_m]$, the frequency range $[f_{\min}, f_{\max}]$ and the damping ratio range $[\zeta_{\min}, \zeta_{\max}]$.

Step 2 Compute all frequencies and damping ratios for $p = [p_1, p_m]$ in the ranges $[f_{\min}, f_{\max}]$ and $[\zeta_{\min}, \zeta_{\max}]$

$$f_{\min} \leq F \leq f_{\max} \quad \text{and} \quad \zeta_{\min} \leq Z \leq \zeta_{\max} \quad (17)$$

Step 3 Define the frequency resolution Δf and make a virtual grid around the frequency range where the number of grid points is defined by

$$N_f = \frac{f_{\max} - f_{\min}}{\Delta f} \quad (18)$$

Step 4 Define the number of repeating frequency in the interval $[\Delta f, 2\Delta f]$, denoted by N_{rf} , where:

$$1 \leq N_{\text{rf}} \leq p_m \quad (19)$$

Set $k = 1$

Step 5 Classify frequencies and damping ratios in the interval as follows

$$[I, \bar{F}] = \text{FIND_STABLE_FREQUENCIES}(f_{\min} + (k-1)\Delta f < F \leq f_{\min} + k\Delta f) \quad (20)$$

$$\bar{Z} = \text{GET_DAMPING_RATIOS}(Z, I) \quad (21)$$

$$\bar{N} = \text{COUNT_STABLE_FREQUENCIES}(\bar{F}) \quad (22)$$

Step 6 If $\bar{N} \geq N_{\text{rf}}$ then \bar{F} , \bar{Z} and the index matrix I (index of \bar{F} in F) is saved to a file.

Step 7 If $k \leq N_f$ then $k = k + 1$ and return **Step 4**. Otherwise, algorithm stops.

In the **Step 1** of the grid technique, the frequency and damping-ratio ranges of interest need to be determined from the user in order to eliminate frequencies and damping ratios out of ranges in the **Step 2**. However, if these ranges are unknown the following values can be used

$$f_{\min} = 0, f_{\max} = \frac{1}{2\Delta t}, \zeta_{\min} = 0, \zeta_{\max} = 100. \quad (23)$$

where $\frac{1}{2\Delta t}$ is the Nyquist frequency.

It can point out that main parameters of the grid technique are the frequency resolution Δf and the number of repeating frequency N_{rf} . By changing these parameter appropriately, the stable frequencies and damping ratios are identified quickly from the stabilization diagrams.

Figure 1 presents a simple example of the proposed technique to detect stable frequencies of the 2-DOF system under the harmonic excitation. Once all frequencies of the system are determined (the model order is increased from 2 to 100), a grid with red color is established over the frequency range from 0 to 100 (Hz). The frequency resolution used to make the grid is 2.5 (Hz) for better illustration. It can see clearly that stable frequencies with blue color lie between two straight red lines. They are detected using **Step 4** of the grid technique. We can conclude that the system may have two natural frequencies and one harmonic excitation associated with near zero damping ratio (see Figure 2).

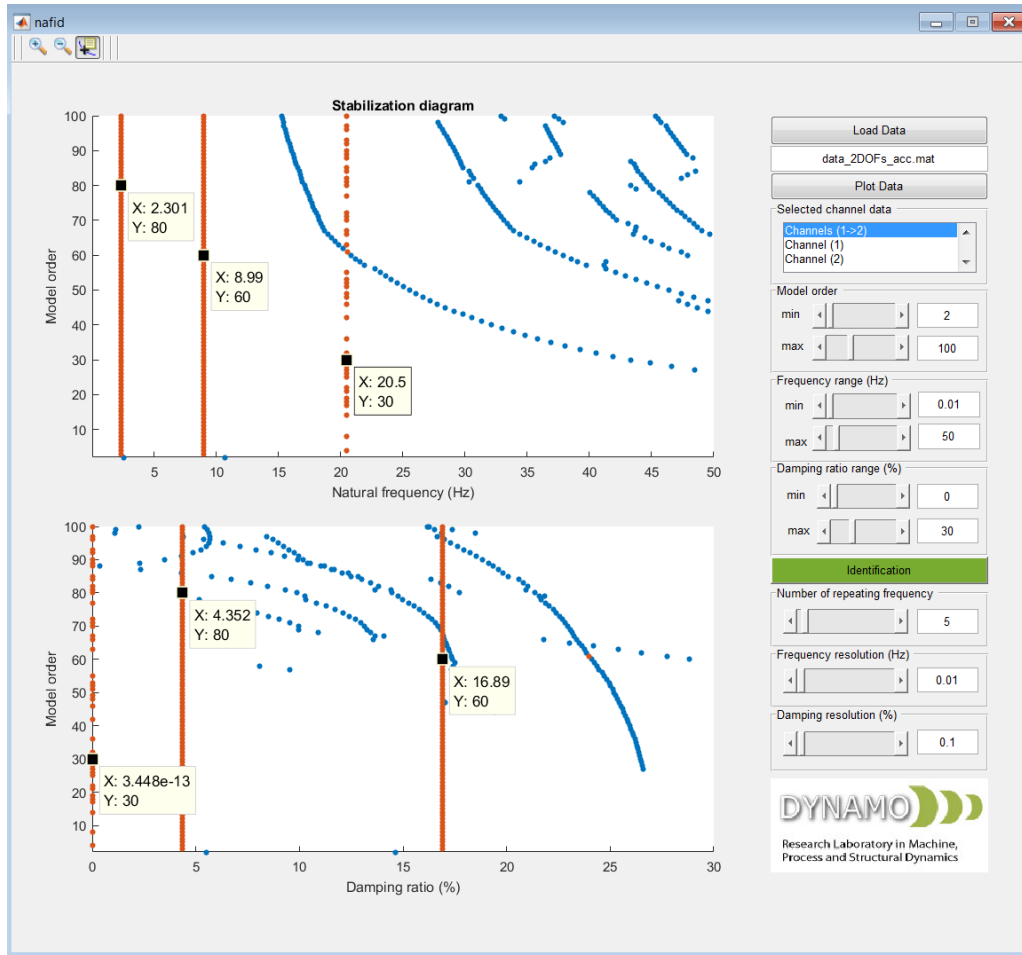

Figure 2 – Interface of the NAFID-tool implemented in Matlab.

3.2 About the NAFID-tool

The NAFID-tool was implemented in Matlab as shown in Figure 2 using the the proposed grid technique. This tool can be used to identify natural frequencies and damping ratios of mechanical systems or structures using the VAR model and the grid technique. On the left is the stabilization diagrams and on the right is the input parameters which are set by the user. The input of the NAFID-tool is the a file (*.mat) including: the sampling time and the measured responds. For example, three stable frequencies as well as three damping ratios of the system presented in Section 3.1 are identified and displayed by orange color. To obtain this result, the parameters of the program are set as follows: the frequency range is [0, 50] (Hz) and the resolution is 0.01 (Hz) while the damping-ratio rang is [0, 30](%) and the number of repeating frequency is 5.

In the next section, modal parameter identification of several mechanical systems is presented to illustrate the efficiency of the grid technique. All results are obtained using the NAFID-tool.

4 Examples

4.1 Modal parameter identification of the 3-DOF system

In the first example, the measured data for the 3DOF system is taken from the Signal Processing Toolbox (Matlab, 2018b) [6] using the command 'load modaldata'. The measured data is shown in 3 in which the sampling rate is 4 (kHz).

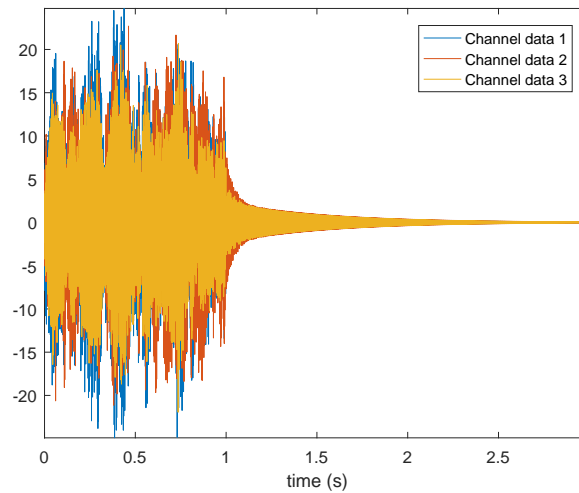

Figure 3 – Time response of 3 channels.

In order to estimate natural frequencies and damping ratios of this system, the following parameters are used in the NAFID-tool: $f_{\min} = 0$ and $f_{\max} = 2000$ (Hz); $\zeta_{\min} = 0.0$ and $\zeta_{\max} = 2(\%)$; $N_{\text{rf}} = 6$. Consequently, stable frequencies are identified as shown in Figure 4 by orange lines. The natural frequencies of the system are $f_1 = 373$, $f_2 = 852.3$ and $f_3 = 1369$ (Hz). The obtained results are almost identical to those obtained using the function 'modalsd' implemented in Matlab. In addition, damping ratios are also identified but very small, less than 0.6(%).

4.2 Modal parameter identification of the 6-DOF system

The mechanical system with 6 degrees of freedom [4] is shown in Figure 5. Using the Lagrange formulation with the generalized coordinates $q = [q_1, q_2, q_3, q_4, q_5, q_6]^T$, equations of motion of the system is given by

$$M\ddot{q} + C\dot{q} + Kq = f \quad (24)$$

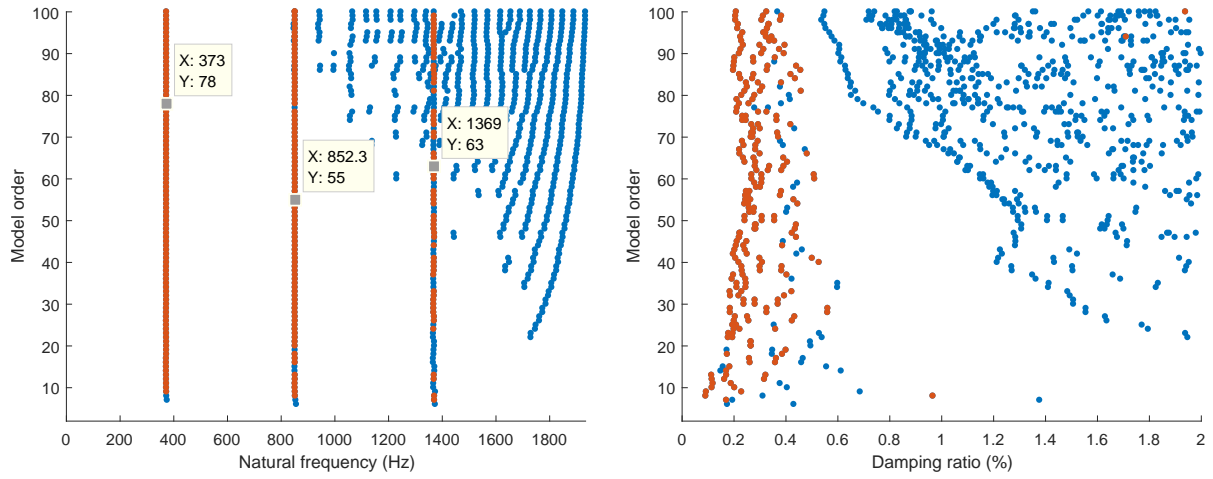

Figure 4 – Modal parameters of the 3DOF system using the NAFID-tool

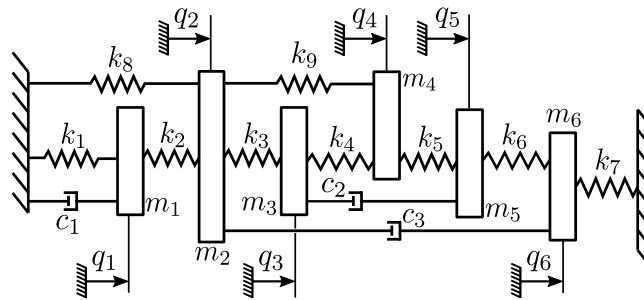

Figure 5 – The mechanical system with 6 DOFs.

where

$$M = \begin{bmatrix} m_1 & 0 & 0 & 0 & 0 & 0 \\ 0 & m_2 & 0 & 0 & 0 & 0 \\ 0 & 0 & m_3 & 0 & 0 & 0 \\ 0 & 0 & 0 & m_4 & 0 & 0 \\ 0 & 0 & 0 & 0 & m_5 & 0 \\ 0 & 0 & 0 & 0 & 0 & m_6 \end{bmatrix}, \quad C = \begin{bmatrix} c_1 & 0 & 0 & 0 & 0 & 0 \\ 0 & c_3 & 0 & 0 & 0 & -c_3 \\ 0 & 0 & c_2 & 0 & -c_2 & 0 \\ 0 & 0 & 0 & 0 & 0 & 0 \\ 0 & 0 & -c_2 & 0 & c_2 & 0 \\ 0 & -c_3 & 0 & 0 & 0 & c_3 \end{bmatrix} \quad (25)$$

$$K = \begin{bmatrix} k_1 + k_2 & -k_2 & 0 & 0 & 0 & 0 \\ -k_2 & k_2 + k_3 + k_8 + k_9 & -k_3 & -k_9 & 0 & 0 \\ 0 & -k_3 & k_3 + k_4 & -k_4 & 0 & 0 \\ 0 & -k_9 & -k_4 & k_4 + k_5 + k_9 & -k_5 & 0 \\ 0 & 0 & 0 & -k_5 & k_5 + k_6 & -k_6 \\ 0 & 0 & 0 & 0 & -k_6 & k_6 + k_7 \end{bmatrix}, \quad (26)$$

For numerical simulation, physical parameters of the system are given by: $m_1 = m_2 = m_5 = 2$ (kg), $m_3 = m_4 = m_6 = 1$ (kg), $k_5 = k_8 = k_9 = 2.0 \cdot 10^6$ (N/m), $k_1 = k_2 = k_3 = k_4 = k_6 = k_7 = 10^6$ (N/m) and $c_1 = c_2 = c_3 = 10^3$ (Ns/m). The system is excited by initial condition with $q = 0$ and $\dot{q} = [0, 10, 0, 0, 0, 0]^T$ and vector of external forces is set to zero ($f = 0$). Using function ODE45 in Matlab, displacement vector is plotted in Figure 6 in which the time step is 0.0001 (s).

Identified frequencies and damping ratios of the system are shown in 7. The parameters used to identify stable frequencies and damping ratios of the system are: $f_{\min} = 0$ and $f_{\max} = 500$ (Hz); $\zeta_{\min} = 0.0$ and $\zeta_{\max} = 70(\%)$; $N_{\text{rf}} = 5$ and $\Delta f = 0.1$ (Hz).

In addition, the theoretical and identified frequencies/damping ratios are shown in Table 1. It can see very good agreement between theoretical and identified modal parameters.

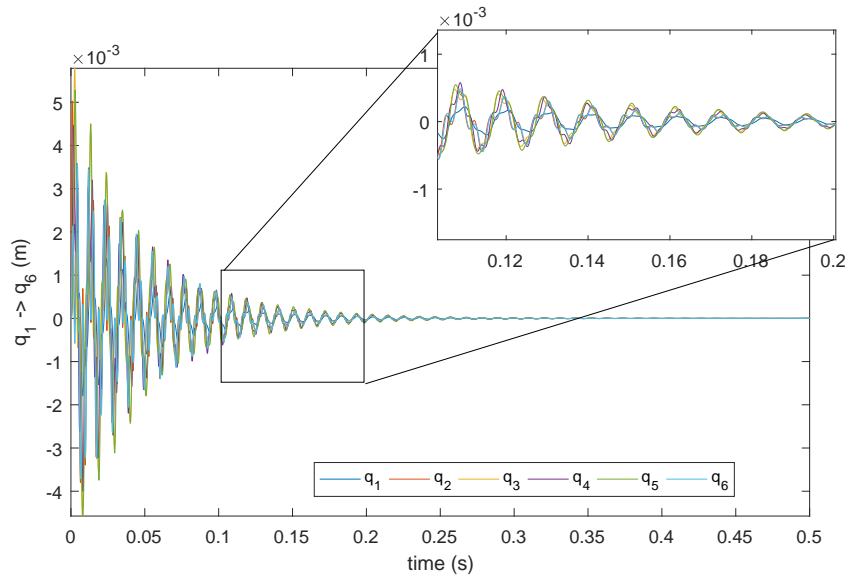

Figure 6 – Displacement vector is calculated using ODE45.

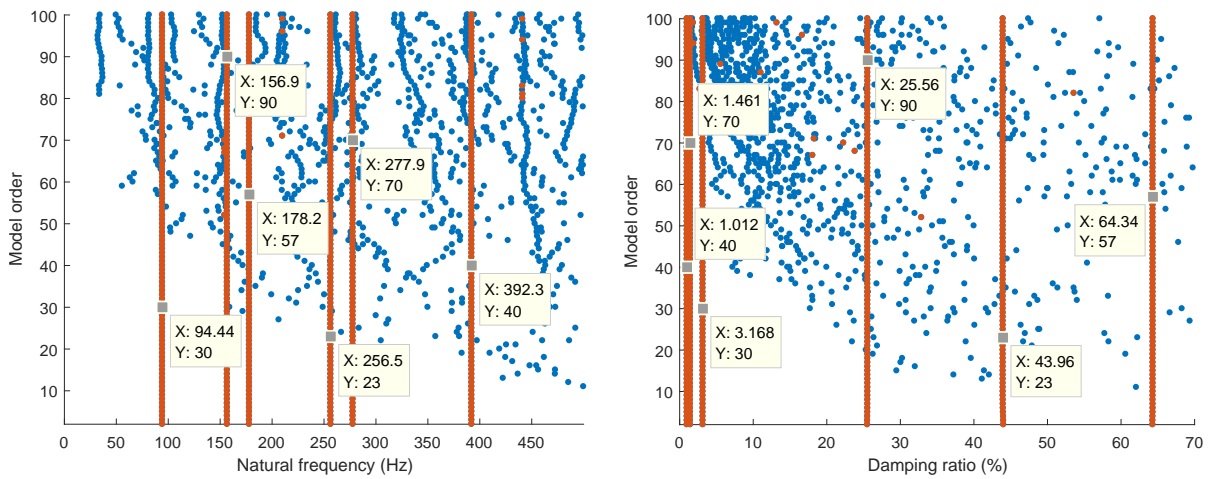

Figure 7 – Modal parameters of the 6DOF-mechanical system using the NAFID-tool

5 Conclusion

The grid technique was proposed in this work to identify modal parameters of mechanical systems using the vector autoregressive model for operational modal analysis. Based on the measured output response and the model order the state matrix was first established and then frequencies and damping ratios were computed using Matlab. Natural frequencies and damping ratios were classified quickly from the stabilization diagram using the grid technique. The NAFID-tool was successfully implemented in Matlab based on this technique. Results obtained based on numerical simulations show that the efficiency of the proposed method. The presented technique can further develop in the future for identifying modal parameters in real applications.

Acknowledgements

The authors would like to acknowledge the Natural Sciences and Engineering Research Council of Canada (NSERC) for its financial support.

Mode	1	1	3	4	5	6
Theoretical frequency (Hz)	94.4415	156.8693	178.1672	256.5395	277.9077	392.2243
Identified frequency (Hz)	94.44	156.9	178.2	256.5	277.9	392.3
Theoretical damping ratio (%)	3.1679	25.5645	64.3426	43.9668	1.4607	1.0039
Identified damping ratio (%)	3.168	25.56	64.34	43.96	1.461	1.012

Table 1 – Natural frequencies and damping ratios of the system using analytical method and the NAFID-tool

References

- [1] M. M. Abdel Wahab and G. De Roeck. An effective method for selecting physical modes by vector autoregressive models. *Mechanical Systems and Signal Processing*, 13(3):449–474, 1999.
- [2] R. Brincker and C. Ventura. *Introduction to Operational Modal Analysis*. Wiley, 2015.
- [3] S. D. Fassois. Parametric identification of vibrating structures. In S. G. Braun, D. J. Ewins, and S. S. Rao, editors, *Encyclopedia of Vibration*, pages 673–685. Academic Press, 2001.
- [4] M. I. Friswell and J. E. Mottershead. *Finite Element Model Updating in Structural Dynamics*. Springer, 1995.
- [5] N. M. M. Maia and J. M. M. Silva, editors. *Theoretical and Experimental Modal Analysis*. Research Studies Press, 1997.
- [6] MathWorks. Signal processing toolbox user’s guide, 2018.
- [7] S. M. Pandit. *Modal and Spectrum Analysis: Data Dependent Systems in State Space*. Wiley-Interscience, 1991.
- [8] V.-H. Vu, Z. Liu, M. Thomas, W. Li, and B. Hazel. Output-only identification of modal shape coupling in a flexible robot by vector autoregressive modeling. *Mechanism and Machine Theory*, 97:141–154, 2016.
- [9] V.-H. Vu, M. Thomas, F. Laffleur, and L. Marcouiller. Towards an automatic spectral and modal identification from operational modal analysis. *Journal of Sound and Vibration*, 332(1):213–227, 2013.
- [10] V.-H. Vu, M. Thomas, A. Lakis, and L. Marcouiller. Operational modal analysis by updating autoregressive model. *Mechanical Systems and Signal Processing*, 25(3):1028–1044, 2011.