



HAL
open science

Toward the quality prognostic of an aircraft engine workpiece in Inconel Alloy 625: case study and proposed system architecture

Antoine Proteau, Antoine S. Tahan, Marc Thomas

► To cite this version:

Antoine Proteau, Antoine S. Tahan, Marc Thomas. Toward the quality prognostic of an aircraft engine workpiece in Inconel Alloy 625: case study and proposed system architecture. Surveillance, Vishno and AVE conferences, INSA-Lyon, Université de Lyon, Jul 2019, Lyon, France. hal-02188568

HAL Id: hal-02188568

<https://hal.science/hal-02188568v1>

Submitted on 18 Jul 2019

HAL is a multi-disciplinary open access archive for the deposit and dissemination of scientific research documents, whether they are published or not. The documents may come from teaching and research institutions in France or abroad, or from public or private research centers.

L'archive ouverte pluridisciplinaire **HAL**, est destinée au dépôt et à la diffusion de documents scientifiques de niveau recherche, publiés ou non, émanant des établissements d'enseignement et de recherche français ou étrangers, des laboratoires publics ou privés.

Toward the quality prognostic of an aircraft engine workpiece in Inconel Alloy 625: case study and proposed system architecture

Antoine PROTEAU¹, Marc THOMAS¹ and Antoine TAHAN¹

¹École de technologie supérieure, Montréal, QC, Canada
antoine.proteau.1@ens.etsmtl.ca

Abstract

Manufacturing companies are under a constant pressure due to multiple factors: new competition, disruptive innovations, cost reduction request, etc. To survive, they must strive to innovate and adapt their business model to improve their productivity. Recent developments based on the concept of Industry 4.0 such as big data, new communication protocols and artificial intelligence provide several new avenues to explore. In the specific context of machining, we are working toward the development of a system capable of making the prognostic of the quality (in terms of dimensional conformance) of a workpiece in real time while it is being manufactured. The goal of this paper is to showcase a prototype of the data acquisition aspect of this system and a case study presenting our first results. This case study has been conducted at our industrial partner facility (Quebec, Canada) and is based on the manufacturing of an aircraft component made from Inconel alloy 625 (AMS5666). The proposed prototype is a data acquisition system installed on a 5 axis CNC machines (GROB model G352) used to acquire and to contextualize the vibration signal obtained from the CNC machine sensor. The contextualization of the data is a key component for future work regarding the development of a prognostic system based on supervised machine learning algorithms. In the end, this paper depicts the system architecture as well as its interactions between the multiple systems and software already in place at our industrial partner. This paper also shows preliminary results describing the relationship between the workpiece quality (in terms of respect toward the dimensional requirements) and the extracted features from the sensors signals. We conclude that it is now possible to do the diagnostic of a cutting operation. Additionally, with the same information we show that it is possible to quickly do the general diagnostic of the health state of the machine. Future work regarding this project will include data acquisition from a wider range of products (i.e. different shapes, materials, processes, etc.) and the development of a machine learning based prognostic model.

1 Introduction

Fuelled by the rapid evolution and introduction of new technologies and new philosophies such as Industry 4.0, the manufacturing industry is quickly transforming. This new manufacturing era brings a lot of possibilities to an industry that is under constant pressure for cost reduction and better quality caused by a global competition [1]. In the specific context of machining; automation and methodologies such as lean manufacturing were the go to solutions to decrease process cost and improve quality output. However, in this new age, possibilities brought by artificial intelligence, more affordable technologies such as sensing technologies and collaborative robotic offer new improvements directions.

In this context, the objective of our research project is to see if we can connect the operational information of a machining process to the physical phenomenon happening during the machining of a workpiece on a CNC machine in order to be able to predict the quality of this workpiece in real-time. Thus, the objective of this paper is to propose a data acquisition system architecture based on the prototype we built, showcase that it is now possible to do the diagnostics of a cutting operation with this system and that we are now able to put in relationship the quality, in terms of the conformity towards a workpiece's G&DT specifications, and the physical phenomenon happening during the machining process.

In a general manufacturing context, attempts have been made to try to predict the quality of a production process. For instance, Wang [2] tried to predict the quality of a chemical batch process operation. However,

their results are based on simulated data and not industrial data such as what we propose. Closer to the machining industry, through our exploration of the literature we have not yet found authors who have proposed a methodology to predict the quality of a whole machining process and the produced workpiece. Nevertheless, we can find articles related to the prognostic of some aspect of a machining process such as predicting the surface roughness. In that context, Benardos, Vosniakos [3] propose a review of the works that have been done in that domain and more recently, Balamurugamohanraj et al. [4] used a machine learning approach and data from an accelerometer to predict the surface roughness in terms of its Ra value.

Even though we have not found many publications with industrial application of prognostic methodology related to the quality of a workpiece, we clearly see an interest for the concept of prognostic in the manufacturing industry. Reviews and publications by authors such as Vogl et al. [5], Wang [6], Peng et al. [7], Lee et al. [8] are all dedicated to the state of the prognostic concept or the proposal of a framework related to manufacturing. Thus, we are not the only one with interest in applying these concepts to a manufacturing context. Still, one of the biggest challenge to the industrial application of such concept and the development of prognostic methodologies is the access to data of good quality and in sufficient quantity. The foremost challenge is addressed in this article.

We also see that, in our research domain, the interest related to applying prognostic methodologies is strong in fields related to tool wear prediction and condition-based maintenance. For instance, Proteau et al. [9] showed that it is possible to predict the tool wear with a Long Short-Term Memory (LSTM) neural network. Balan, Epureanu [10, 11] and Aghazadeh et al. [12] also proposed different methodologies based on artificial intelligence approaches to monitor and predict the cutting tool condition. Related to condition-based maintenance, Waqar, Demetgul [13] and Aydin, Guldamlasioglu [14] also suggested methodologies based on artificial intelligence to predict the state of an equipment or a component (e.g. bearing, gears, etc.).

To improve the state of this research domain and to make a step toward the industrial application of prognostic methodologies, this paper will present our most recent work to show that it is now possible to put the workpiece quality in relationship with the physical phenomenon happening during the machining process. We also want to prove that we are now making a step forward to go from being able to diagnose a cutting operation toward being able to predict the quality of that process. To do so, this article is structured as follows: section 2 will introduce our research partner as well as our research environment and equipment. Then, in section 3, we propose a data acquisition (DAQ) system architecture and describe the dataset built. In section 4, we present our signal processing methodologies and the different features that we extracted from the acquired signals. In section 5, we detail our results and show that it is now possible to do the diagnostic of a cutting operation as well as working toward the prognostic of the quality of a workpiece. Finally, in section 6, we make our conclusions.

2 Research environment

To pursue this research project, we are collaborating with an industrial partner: APN Inc.¹ APN is a leader of the machining industry as well as at the forefront of the Industry 4.0 movement in Quebec, Canada. They are specialized in the machining of complex products in exotic material (i.e. titanium, Inconel, etc.) for the aerospace and high-tech industry.

In our research context, our work was done on a 5 axis CNC machine made by GROB, model G352 (see Figure 1). This machine was acquired in 2017.

¹ More information here : <http://apnglobal.ca/en/apn/>

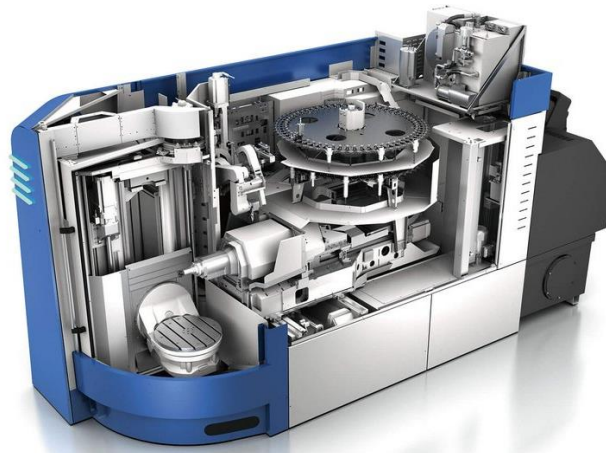

Figure 1 GROB G352 CNC machine²

It is also important to state that, to be able to acquire a vibration signal, we worked with the GROB employees to have access to the accelerometer already installed into the machine's spindle. Thus, the signal was acquired through an IFM VSA004³ accelerometer on which the signal was amplified with a Phoenix Contact signal conditioner model MACX MCR-UI-IU⁴. From Figure 2, we can see where the accelerometer was installed by the manufacturer (as indicated by the bubble #1). This information was provided by the GROB documentation available at APN Inc. In the next section, we present our DAQ system architecture.

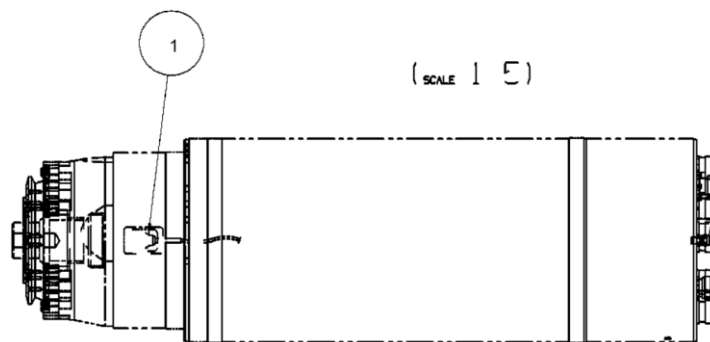

Figure 2 Accelerometer location in the spindle

3 Data acquisition system architecture

One of our hypothesis is that, in order to be able to predict the quality of a workpiece based on the physical information of the CNC machine, we must contextualize the signals acquired from sensors. Therefore, we developed a data acquisition system to automatically execute this operation. Figure 3 shows the contextualization of the data in terms of its relationships.

² Picture source : <https://www.grobgroup.com/en/products/product-range/universal-machining-centers/milling-centers/g350/>

³ Specifications : <https://www.ifm.com/ca/en/product/VSA004>

⁴ Specifications : <https://www.phoenixcontact.com/online/portal/ca?uri=pxc-oc-itemdetail;pid=2811446&library=caen&tab=1>

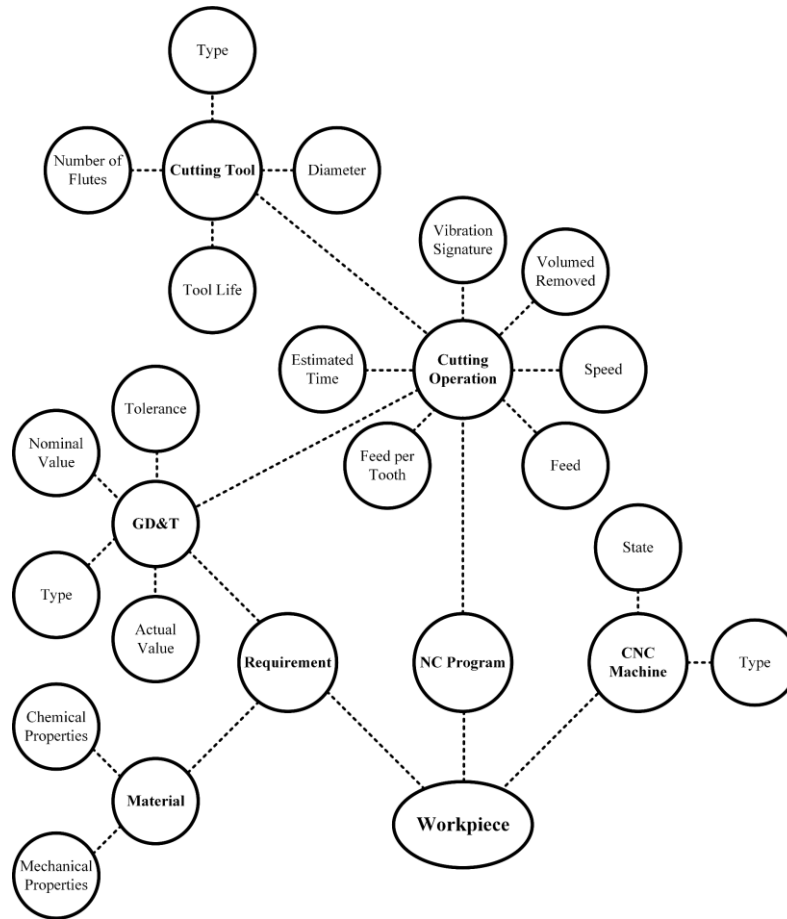

Figure 3 Relationships between data sources

Whit this figure, we can see that, through this system, it is possible to create a relationship that goes from the workpiece requirements (including the actual measurements made on a finished workpiece) up to the vibration signature of a specific cutting operation. This means that at every moment during the machining process, we can know which cutting operation was being executed, its vibration signature, what was the cutting tool and its cutting parameters as well as which GD&T was influenced. To achieve these relationships, multiple data sources must be integrated. Table 1 shows the source of each data types.

| Data types | Sources |
|-------------------------|---|
| Workpiece Requirements | APN Quality System (From the technical drawing) |
| Actual Measurements | APN Quality System |
| Material Properties | APN Quality Documents System |
| CNC Machine information | Machine controller through OPC Protocol |
| Cutting Operation | CAM Software |
| Cutting Tool | CAM Software |
| Vibration signal | Accelerometer and National Instruments Card |

Table 1 Data sources by data types

To automatically integrate these data sources and create the relationships between the data, we developed an acquisition system that had to take into account the state of the machine (cutting or not, on idle, etc.). To illustrate our acquisition system, Figure 4 shows an overview of the acquisition process. On this figure, we can also see the isometric view of the workpiece as well as the quality data flow.

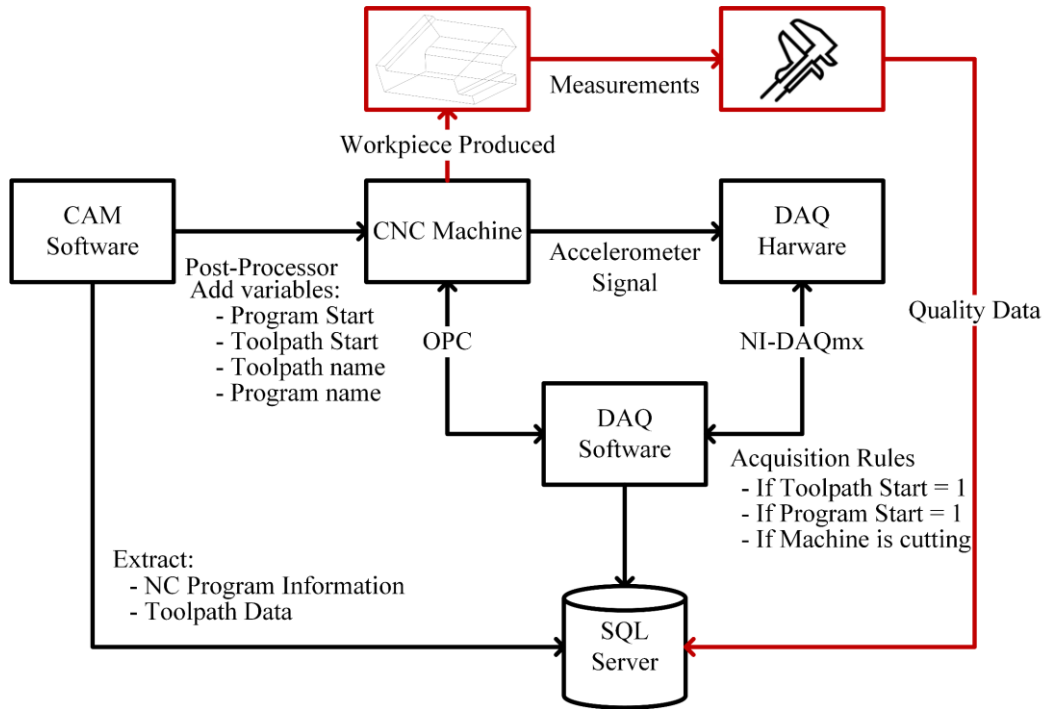

Figure 4 DAQ System architecture

We worked with our industrial partner to modify their post-processor program to add four variables: when the NC Program start/stop, when a cutting operation start/stop, the cutting operation name and the NC Program name for reference. This modification allowed us to control the behaviour of the National Instruments data acquisition card by sampling the signal only when the machine was actually cutting the workpiece. However, since we are in a production environment, different machine states can also arise: the machine is in idle during a cutting operation, an alarm is raised, etc. Therefore, in our acquisition rules, we added some logic based on variables extracted in real-time from the CNC machine controller through the OPC communication standard. The reader can refer himself to the Siemens Sinumerik 840D SL documentation for a complete list of all available variables.

During the acquisition process, the raw signal is thus contextualized and attached to the current workpiece and the current cutting operation being executed on the CNC machine. This, consequently, gives us a contextualized vibration signal suited to model the relationships between the physical and operational data (the model input) and the actual measurement in terms of GD&T (the model output). The next section presents an overview of the data collected.

3.1 Dataset overview

To prove the concept and functionalities of our proposed system, we conducted a first acquisition process. The acquisition was made during the machining of an Inconel 625 (AMS5666) workpiece intended for the aerospace industry. During our acquisition process, we were able to cover the entirety of the machining process which means:

- 22 different cutting tools;
- 140 cutting operations of multiple types;
- 135 GD&T to be respected for a workpiece to be considered conform.

The acquired data covers five finished workpieces which represents approximately 13 hours of machining process. Unfortunately, due to industrial constraints, we were not able to gather more workpiece. However, this information is sufficient to prove our concept and start our analysis. In this article, we focused on one specific operation where measurements were made for every workpiece to showcase our results. Information related to this operation can be found in Table 2. Information regarding the cutting tool used during the cutting

operation can be found in Table 3. The cutting tool was new at the beginning of the machining process and was not changed during the machining of the five workpieces. For visualization, Figure 5 shows the cutting operation strategy obtained from the CAM software and Figure 6 shows the difference between the finished workpiece and the raw material used. Due to confidentiality, the 3D model shown in this paper have been redesign to showcase the overall shape of the workpiece and not the actual geometry.

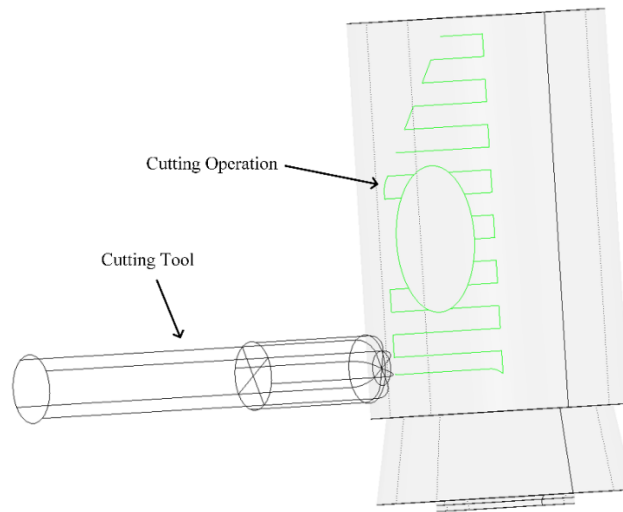

Figure 5 Cutting operation *OP_510*

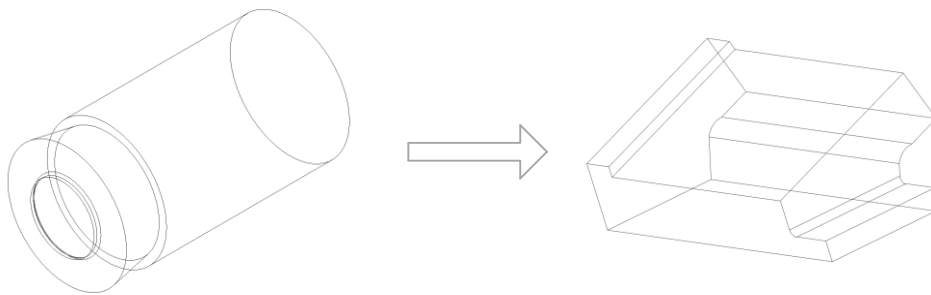

Figure 6 Difference between the raw material and the finished workpiece

| Name | Type | Spindle speed [RPM] | Feed [mm/s] | Est. cutting time [min] | Volume removed [cm ³] | Coolant pressure [MPa] |
|--------|--------------|---------------------|-------------|-------------------------|-----------------------------------|------------------------|
| OP_510 | Face Milling | 1047 | 233.934 | 2.5 | 0.078 | 6 |

Table 2 Cutting operation information

| Name | Type | Diameter [mm] | Radius [mm] | Number of flutes |
|-------------------------|-----------------|---------------|-------------|------------------|
| EMR0.500R0.125L4LG1.100 | Radius End Mill | 12.7 | 3.175 | 4 |

Table 3 Cutting tool information

By connecting our system to the quality system of APN, we are able to associate the cutting operation with the specifications (GD&T) influenced by that operation. These associations are made by expert employees at APN. Thus, for this project, we assumed that the associations are good. Through these associations, we know that the *OP_510* operation influences the specification #15. Details about this specification is found in Table 4.

| Number | GD&T type | Minimum value [μm] | Maximum value [μm] | Severity | Illustration [μm] | Inspection tool used |
|--------|-----------|--------------------|--------------------|----------|--|----------------------|
| 15 | Flatness | 0 | 25.4 | Critical |  25.4 | CMM |

Table 4 Details of the GD&T specification #15

The interpretation of this type of GD&T was made according to the standard Y14.5 [15]. The reader can refer to ASME [15] for further details.

For the five workpieces, Figure 7 shows each actual measurements made by the operator after each workpiece was produced.

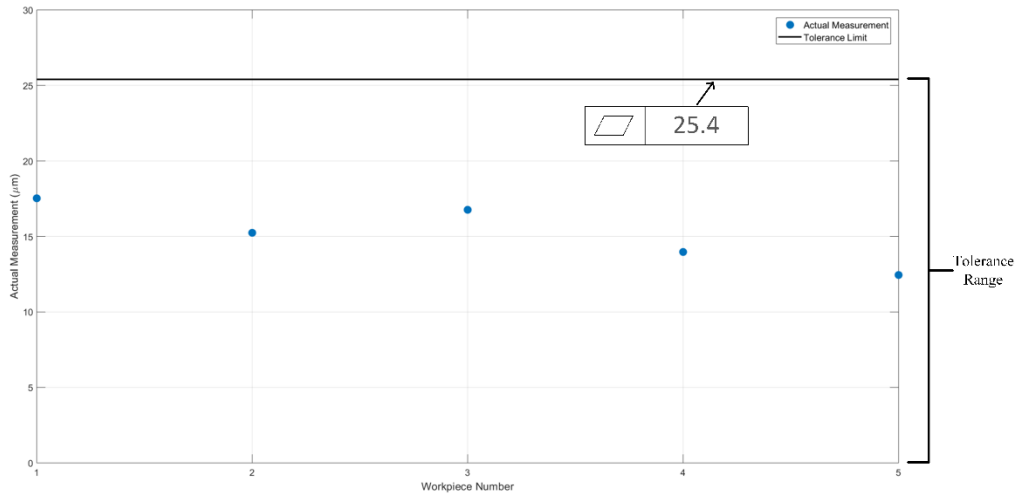

Figure 7 Actual measurement per workpiece for the specification #15

The next section will present the signal processing methodology applied to the data acquired.

4 Signal processing methodology

We have shown in the previous section that we can now acquire a signal that is well contextualized. The objective of this section is to describe our signal processing methodology in order to be able to do the diagnostic of the machining process as well as the production equipment itself; taking a step toward a predictive methodology.

Our methodology is segmented in two sections: a time domain methodology and a frequency domain methodology. Once acquired, each signal sampled file is cleaned and has several features extracted. The signal features used are described below and are chosen according to the work of Lei et al. [16], Elattar et al. [17] and Abellan-Nebot, Romero Subirón [18].

4.1 Time domain

To describe the signal in the time domain, we used equation (1) to equation (5) which refer respectively to the Root Mean Square (*RMS*), the Kurtosis (*K*), the Peak value (*Peak*), the Peak-to-Peak value (*PTP*) and the Crest Factor (*CF*).

$$RMS = \sqrt{\frac{1}{N} \sum_{i=1}^N (x_i - \bar{x})^2} \quad (1)$$

$$K = \frac{\sum_{i=1}^N (x_i - \bar{x})^4}{\frac{1}{N} [\sum_{i=1}^N (x_i - \bar{x})^2]^2} \quad (2)$$

$$Peak = \max(x) \quad (3)$$

$$PTP = \max(x) - \min(x) \quad (4)$$

$$CF = \frac{Peak}{RMS} \quad (5)$$

Where x is a signal of N samples, x_i is the value of i^{th} sample and \bar{x} is the average of x .

4.2 Frequency domain

In the frequency domain, we are interested in following the evolution, through time, of the cutting tool frequency (A_{CT}). This is because the degradation of the tool is one of the major cause of the degradation of a machining process. To do so, we used equation (6). This equation is similar to the *RMS* equation in the sense that we could interpret its result as being the energy content of the signal around a specific frequency.

$$A_{CT} = \sqrt{\sum_{i=a}^b A_i^2} \quad (6)$$

Where A_i is the amplitude of the signal at the i^{th} frequency and a and b are the two corners of the window. In our case, we assigned $a = 64$ Hz and $b = 75$ Hz, which correspond to ± 5 Hz around the frequency of interest (f_i). We are also interested in making the same measurement at the different harmonics of the cutting tool frequency, thus we also applied the same equation at the 2nd, 3rd, 4th and 5th harmonics ($2f_i$, $3f_i$, $4f_i$ and $5f_i$).

To improve the physical meaning of this feature we use the work of Proteau et al. [9]. In Proteau et al. [9], the authors proposed an adaptation of the specific cutting energy (SCE, k_c) metric first established by Debongnie [19]. In their work, the authors used their version of the SCE to show that it can adequately represents tool wear degradation. Their version is defined by equation (7).

$$k_c = \frac{P_{Tool}[W]}{Q[\text{cm}^3\text{s}^{-1}]} = \frac{[\text{J}\text{s}^{-1}]}{[\text{cm}^3\text{s}^{-1}]} = [\text{Jcm}^{-3}] \quad (7)$$

Where P_{Tool} is the power [W] consumed by the cutting tool and Q is the material removal rate express in cm^3s^{-1} .

SCE is therefore defined in terms of the energy required to remove and keep a certain rate of material removal in a specific material (aluminum, Inconel, etc.). The reader can refer himself to Proteau et al. [9] for the details. Since we do not have the actual power transmitted to the cutting tool, we can estimate this value by using the energy contained in the signal at the frequency related to the cutting tool (A_{CT}). For the same material and a constant material removal rate, k_c should be constant. In case of tool wear, k_c increase through time. The next section will present the results of our analysis.

5 Results and discussion

We first present the results of our analysis in the time domain. Figure 8 shows the values of the *RMS*, *Peak* and *PTP* values through time for each workpiece.

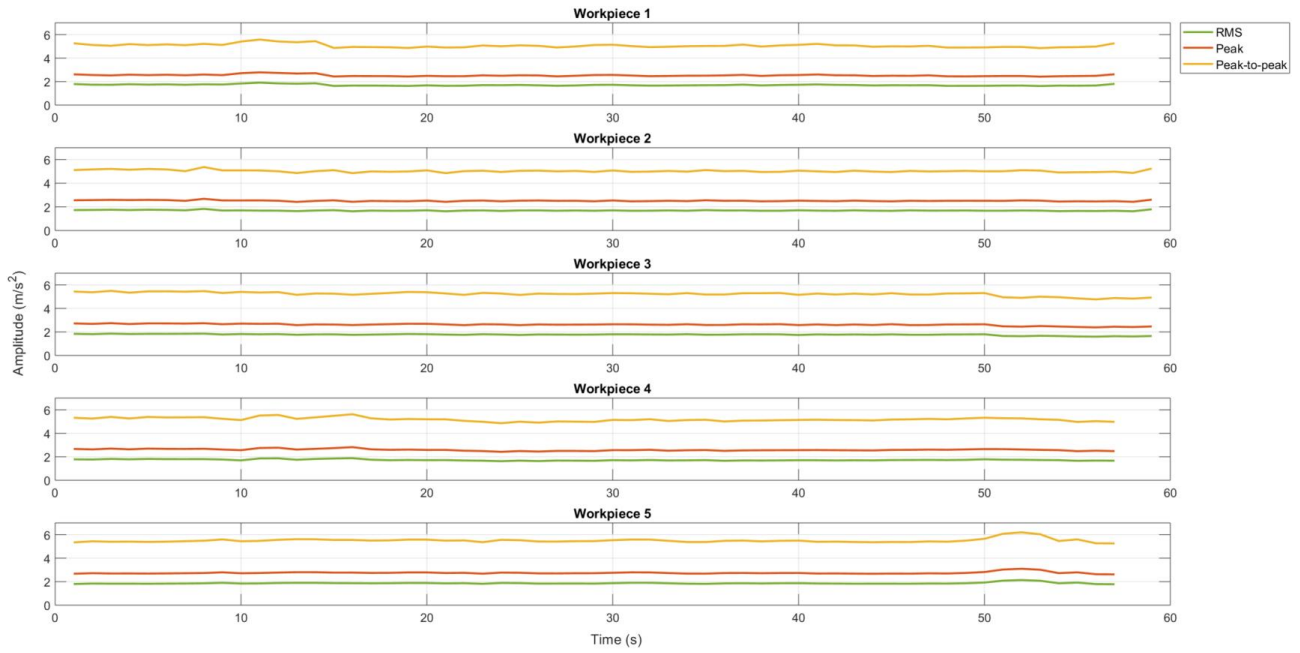

Figure 8 *RMS*, *Peak* and *PTP* values through time per workpiece

Then, Figure 9 presents the average values for the *RMS*, *Peak* and *PTP* value per workpiece. We also included the evolution of the actual measurement per workpiece for the specification #15 to see if there is a direct relationship between the evolutions of the two phenomenon that could be visually witnessed.

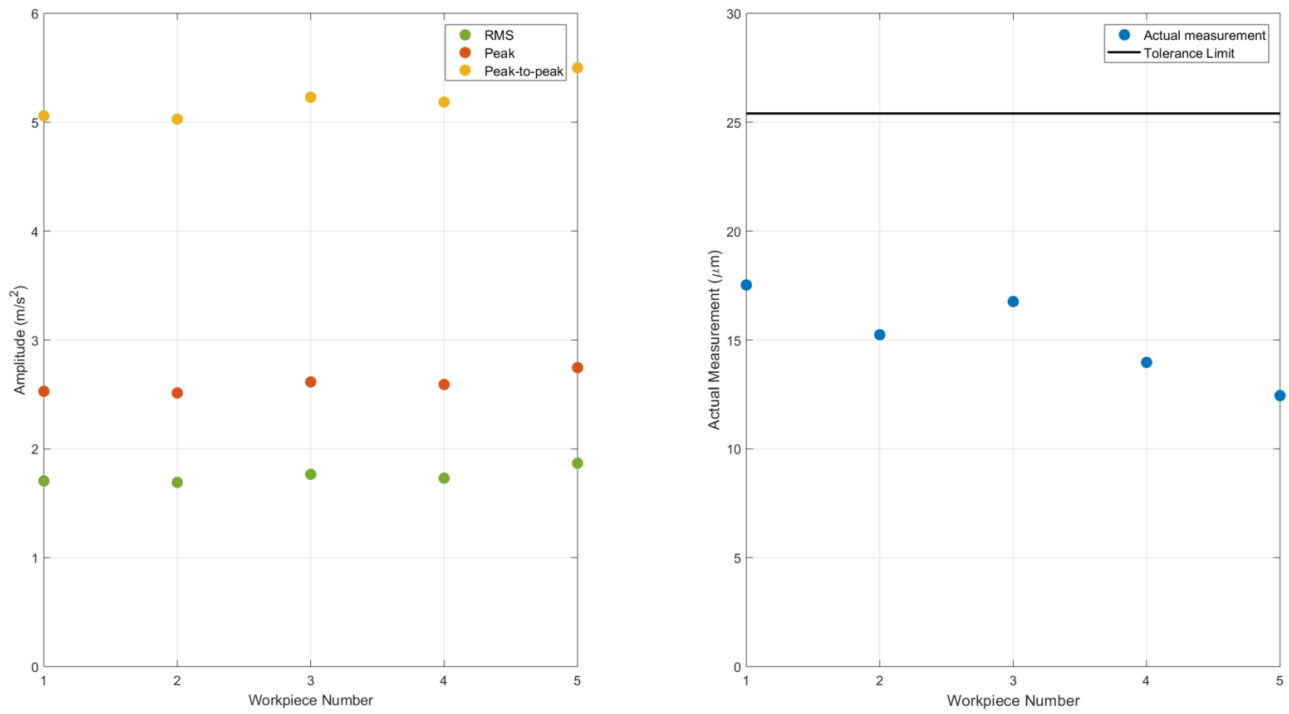

Figure 9 *RMS*, *Peak* and *PTP* values per workpiece and actual measurement per workpiece

We did the same analysis with the kurtosis and the crest factor. Results are shown in Figure 10 and Figure 11.

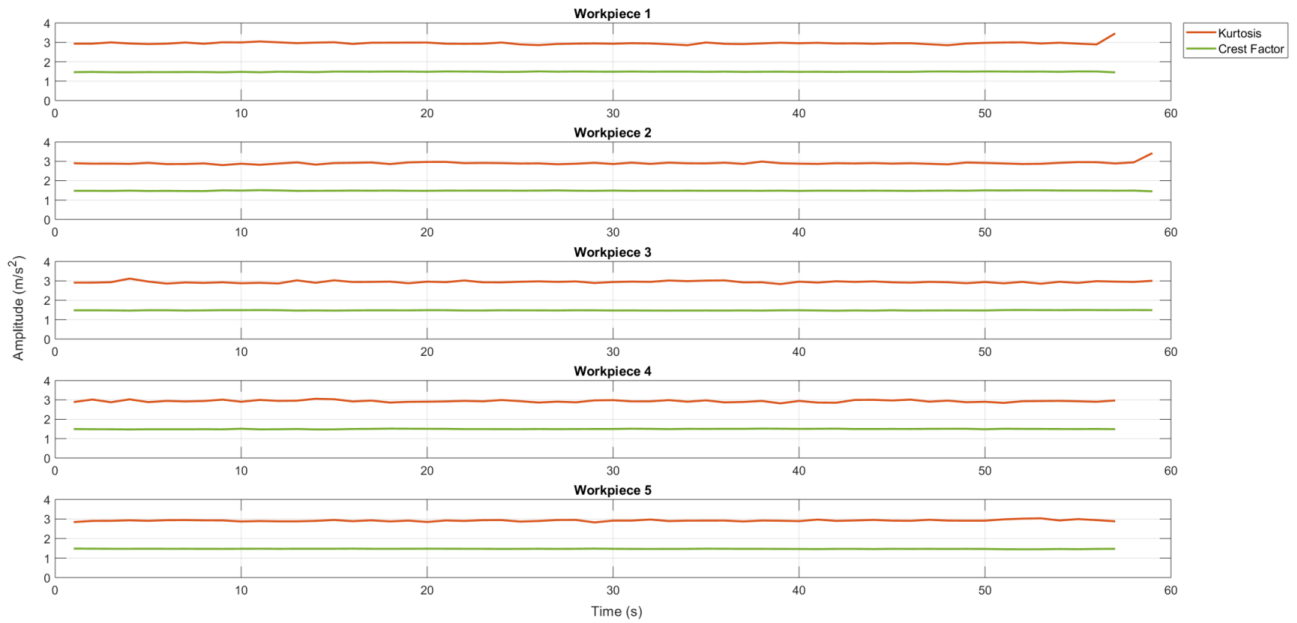

Figure 10 *K* and *CF* values through time per workpiece

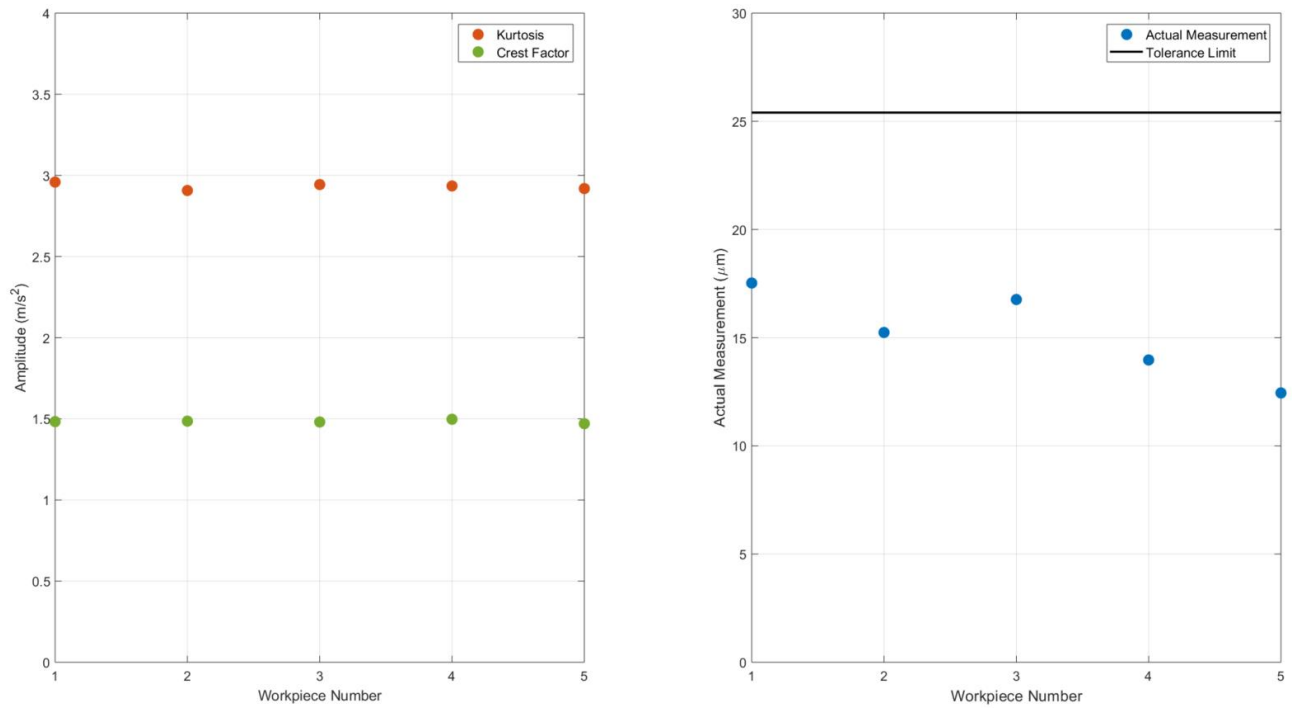

Figure 11 *K* and *CF* values per workpiece and actual measurement per workpiece

We then did the same analysis in the frequency domain. Results of the SCE values for each harmonics are shown in Figure 12 and Figure 13.

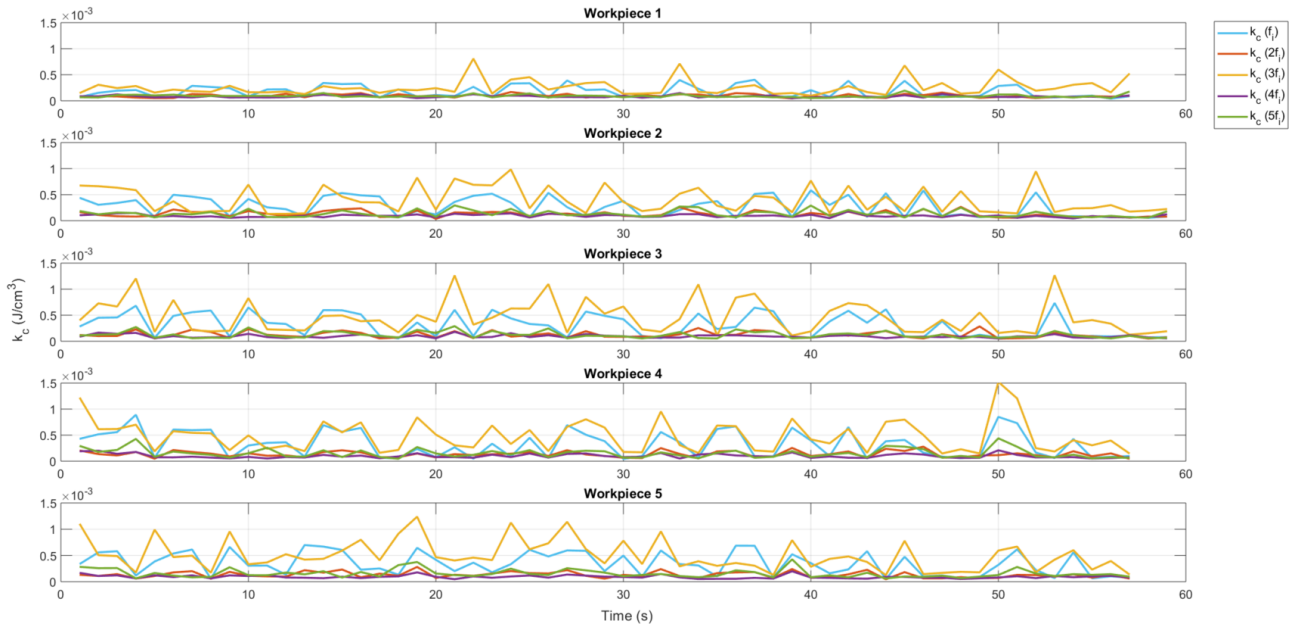

Figure 12 k_c values for each harmonics of f_i through time per workpiece

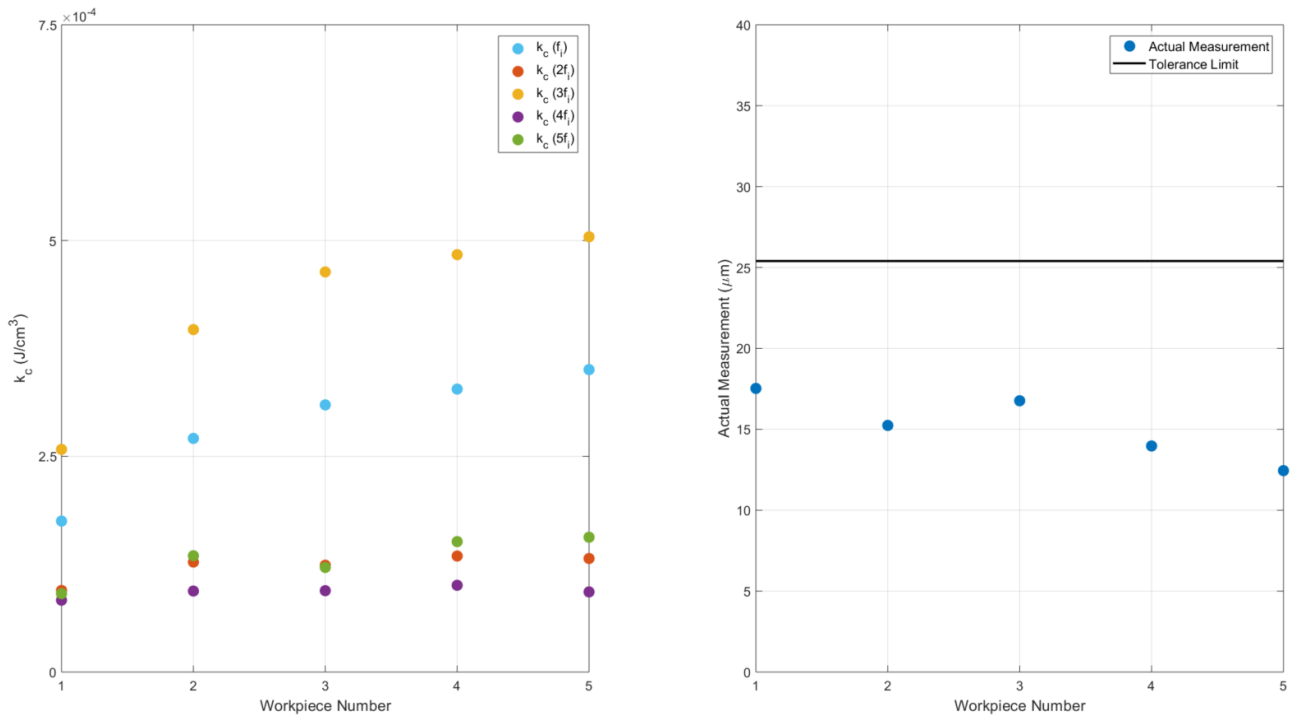

Figure 13 k_c values for each harmonics of f_i per workpiece and actual measurement per workpiece

Finally, we also did a time-frequency analysis where we looked at the frequency domain of the signal through time. Figure 14 presents the spectrogram we obtained. The white lines represent the separation between each workpiece; starting to the left with workpiece 1 up to the right with workpiece 5. In a) we gave the spectrogram for the frequencies between 0 and 400 Hz and in b) for the frequencies 400 to 1000 Hz. Most frequencies of interest are located in the range of 0 to 1 kHz.

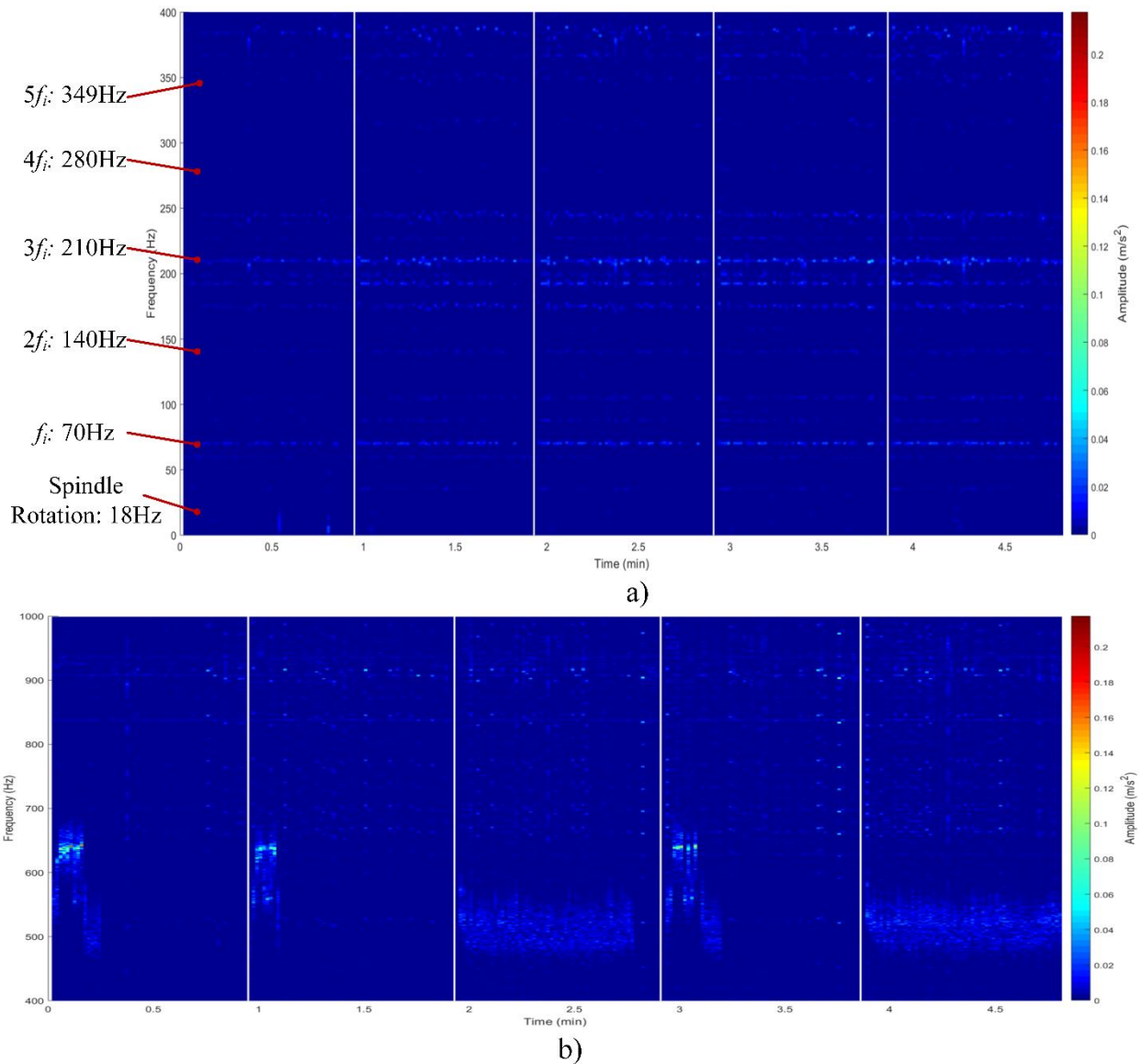

Figure 14 Time-frequency analysis for all the workpiece

From Figure 8, we can see that, for all workpieces, most values are comprised between an amplitude of 0 and 6 m/s²; with some peaks during the machining process of each workpiece. However, we cannot clearly see that there was either a degradation or an improvement regarding the machining process in a part-to-part point of view. Also, when we look at the average values per part in Figure 9, we cannot clearly state that there is a direct relationship between the actual measurement and the evolution of the *RMS*, *Peak* or *PTP*.

We could conclude the same thing regarding the evolution of the *K* and *CF* through time with the results shown in Figure 10 and Figure 11. However, it is interesting to also use these results to do the diagnostic of the machine health state. Based on these results, we could conclude that the machine is in a good health state. From Thomas [20], a kurtosis value around a value of 3 means a random signal, hence a machine in good health where no spike or impact were recorded. Values higher than that would start to indicate that impacts are being recorded. This is also supported by the values of the crest factors which are low and near the value indicating a good condition ($CF = 1.41$). We also tried to look at the fundamental frequencies related to the bearings installed in the spindle. However, since the machine and its component are relatively new, the amplitudes related to the typical fault (FTF, BPFI, etc.) do not stand out. This could indicate that they are in good condition and that their signal is lost in the noise of the machine during the machining process. A diagnostic when the machine is not cutting could probably help us identify with better accuracy these frequencies.

From Figure 12, we can see that the variation in terms of amplitude seems to increase between the workpiece 1 and workpiece 5. This would seem to be consistent with the claim of Proteau et al. [9] that the energy required to keep a material removal rate is increasing with tool wear. When we look at Figure 13, we can see that the values are increasing with every workpiece; for the first and third harmonics (f_i and $3f_i$). The 2nd, 4th and 5th harmonics ($2f_i$, $4f_i$ and $5f_i$) seem to have a low amplitude throughout the data we collected.

Moreover, when we look at the scale of the amplitude of the data, we can see that they are pretty low. This is somewhat counter intuitive to our belief. We believed that because the Inconel 625 is a very hard and difficult material to work with, we would have seen very high amplitudes due to the force required to remove the material. It was not possible to get the exact depth of cut used in this operation, therefore, maybe the engineers responsible of this product at APN used a very low depth of cut parameter in order to create less friction between the material and the cutting tool in order to facilitate the machining process.

When we look at the spectrogram shown in Figure 14, we can quickly see that the overall frequencies' amplitudes are consistent with our previous claim; it is low across most frequencies. We can still detect some frequencies of interest such as the spindle rotation (1047 RPM = 17.45 Hz), the cutting tool frequency (with 4 flutes: 69.8 Hz) and its harmonics (139.6 Hz, 209.4 Hz, 279.2 Hz and 349 Hz).

Aside from these specific frequencies, this low amplitude claim seems to hold true except for some spontaneous peak between 600 and 700 Hz. In fact, if we look at the graph in b), we see a phenomenon where we have not yet found the source. No video recording was made during the acquisition process. This kind of data would surely help us to correlate such phenomenon with actual events during the machining process. Additionally, this phenomenon is not consistent across all workpiece. Cutting parameter and overall machining strategy were not changed between the workpieces, hence we would have expected a similar pattern for each workpiece. However, we can denote two patterns: one related with workpiece 1, 2 and 4 and the other with the workpiece 3 and 5. The peaks in amplitude are also related to the first pattern for workpiece 1, 2 and 4.

In a diagnostic point of view, our conclusion related to the kurtosis and crest factor values seems to hold in the frequency domain since we do not seem to detect traces of impact during the utilization of the equipment.

The objective of this paper was to demonstrate that we can now have access to data allowing us to describe and diagnose a machining process and its cutting operations as well as making a step toward being able to do the prognostic of the overall quality of a workpiece. With the results shown in this section we can conclude that the proposed data acquisition architecture enable us now to adequately contextualize, in real-time and automatically, signals acquired through sensing devices. However, when we look at the final objective of our project; that is the prognostic of the quality of a workpiece in term of the respect of its GD&T requirements, we have not seen a clear linear relationship or pattern between the cutting operation vibration signal and the evolution of the actual measurement of the specification #15 neither in the time and frequency domain. Throughout this article, we have been looking at one operation influencing the specification #15; in fact, there is a total of 11 cutting operations influencing this specific requirement. In other words, we conjecture that a clear linear relationship cannot be establish between only one operation and the evolution of a specific requirement. On the contrary, it is maybe the "sum" or sequence of all these operations that could influence the conformity of a workpiece specific requirements. In other words, all the variations across all these operations could explain the evolution of a specification. Consequently, we believe that only through a machine learning approach we could be able to predict the quality of a workpiece. Our strategy to apply such approach to this research project still hold to this point.

6 Conclusion

To conclude this article, we wanted to showcase our data acquisition system architecture and demonstrate that we can now adequately contextualize a vibration signal to better do the diagnostic of a cutting operation to, in the end, facilitate the development of a prognostic methodology for the quality of a workpiece. We

believe that we have successfully achieve these objectives by showing multiple results related to the cutting operation *OP_510*. However, we have not yet been able to showcase a linear relationship between the vibration signal of this operation and the evolution of the quality of the workpiece. The use of a machine learning approach could probably help us achieve this objective. Further work in order to close the gap between our current status and our final objective to predict the quality of a workpiece will include adding sensors to the GROB CNC machine: a tri-axial accelerometer, an acoustic emission sensor, current and voltage sensors to the motor of the spindle as well as the ones of the three main working axis of the CNC machine and try to apply cyclostationarity analysis based on the work of Lamraoui et al. [21]. We will also expand our system capacity to have it works in a more autonomous way and we will finally use and apply multiple machine learning approaches to perform sensors fusion and the actual prediction of a workpiece quality.

Acknowledgments

The authors would like to thank APN Inc.: their owners, Jean and Yves and all their employees related to this project for their support and time in helping our research team. Special thanks to Alain, Jonathan, Michel, David, Daniel, Raphael, Maxim and Mathieu for the many questions they answered and their help to make this project happen. We would also like to acknowledge the financial support of the *Fonds de Recherche du Québec – Nature et Technologies* (FRQNT) to this project through Grant #257668.

References

1. Kohler D, Weisz J-D (2016) *Industrie 4.0 Les défis de la transformation numérique du modèle industriel allemand*. France
2. Wang D (2011) *Robust Data-Driven Modeling Approach for Real-Time Final Product Quality Prediction in Batch Process Operation*. *IEEE Transactions on Industrial Informatics* 7 (2):371-377
3. Benardos PG, Vosniakos GC (2003) *Predicting surface roughness in machining: a review*. *International Journal of Machine Tools and Manufacture* 43 (8):833-844
4. Balamurugamohanraj G, Vijaiyendiran K, Mohanaraman P, Sugumaran V (2016) *Prediction of Surface Roughness Based on Machining Condition and Tool Condition in Boring Stainless Steel-304*. *Indian Journal of Science and Technology* 9 (47):6
5. Vogl GW, Weiss BA, Helu M (2016) *A review of diagnostic and prognostic capabilities and best practices for manufacturing*. *Journal of Intelligent Manufacturing*:1-17
6. Wang K-S (2013) *Towards zero-defect manufacturing (ZDM)—a data mining approach*. *Advances in Manufacturing* 1 (1):62-74
7. Peng Y, Dong M, Zuo MJ (2010) *Current status of machine prognostics in condition-based maintenance: a review*. *The International Journal of Advanced Manufacturing Technology* 50 (1):297-313
8. Lee J, Jin C, Bagheri B (2017) *Cyber physical systems for predictive production systems*. *Production Engineering* 11 (2):155-165
9. Proteau A, Tahan A, Thomas M (2019) *Specific cutting energy: a physical measurement for representing tool wear*. *The International Journal of Advanced Manufacturing Technology*:1-10
10. Balan GC, Epureanu A (2008) *The monitoring of the turning tool wear process using an artificial neural network. Part 1: The experimental set-up and experimental results*. *Proceedings of the Institution of Mechanical Engineers, Part B: Journal of Engineering Manufacture* 222 (10):1241-1252
11. Balan GC, Epureanu A (2008) *The monitoring of the turning tool wear process using an artificial neural network. Part 2: The data processing and the use of artificial neural network on monitoring of the tool wear*. *Proceedings of the Institution of Mechanical Engineers, Part B: Journal of Engineering Manufacture* 222 (10):1253-1262
12. Aghazadeh F, Tahan A, Thomas M (2018) *Tool Condition Monitoring Using Spectral Subtraction Algorithm and Artificial Intelligence Methods in Milling Process*. *International Journal of Mechanical Engineering and Robotics Research* 7 (1):30-34
13. Waqar T, Demetgul M (2016) *Thermal analysis MLP neural network based fault diagnosis on worm gears*. *Measurement* 86:56-66
14. Aydin O, Guldamlasioglu S *Using LSTM networks to predict engine condition on large scale data processing framework*. In: 2017 4th International Conference on Electrical and Electronic Engineering (ICEEE), 8-10 April 2017 2017. pp 281-285

15. ASME (2009) *Dimensioning and Tolerancing; Engineering Drawing and related documentation practices*. American Society of Mechanical Engineers, New York, NY
16. Lei Y, Li N, Guo L, Li N, Yan T, Lin J (2018) *Machinery health prognostics: A systematic review from data acquisition to RUL prediction*. *Mechanical Systems and Signal Processing* 104:799-834
17. Elattar HM, Elminir HK, Riad A (2016) *Prognostics: a literature review*. *Complex & Intelligent Systems* 2 (2):125-154
18. Abellan-Nebot JV, Romero Subirón F (2010) *A review of machining monitoring systems based on artificial intelligence process models*. *The International Journal of Advanced Manufacturing Technology* 47 (1):237-257
19. Debongnie J-F (2006) *Usinage*. Editions du CEFAL,
20. Thomas M (2011) *Fiabilité, maintenance prédictive et vibration des machines*. Presses de l'Université du Québec, Montréal
21. Lamraoui M, Thomas M, El Badaoui M, Girardin F *Cyclostationarity analysis of instantaneous angular speeds for monitoring chatter in high speed milling*. In: *IECON 2012 - 38th Annual Conference on IEEE Industrial Electronics Society*, Montreal, Qc, Canada, 25-28 Oct. 2012 2012. pp 3868-3873