



HAL
open science

Shunted piezoelectrical flexensionnal suspension for vibration insulation

Kevin Billon, Nathan Montcoudiol, Alice Aubry, Rémi Pascual, Frederic Mosca, Frederic Jean, Charles Pezerat, Charlie Bricault, Simon Chesné

► To cite this version:

Kevin Billon, Nathan Montcoudiol, Alice Aubry, Rémi Pascual, Frederic Mosca, et al.. Shunted piezoelectrical flexensionnal suspension for vibration insulation. Surveillance, Vishno and AVE conferences, INSA-Lyon, Université de Lyon, Jul 2019, Lyon, France. hal-02188566

HAL Id: hal-02188566

<https://hal.science/hal-02188566>

Submitted on 18 Jul 2019

HAL is a multi-disciplinary open access archive for the deposit and dissemination of scientific research documents, whether they are published or not. The documents may come from teaching and research institutions in France or abroad, or from public or private research centers.

L'archive ouverte pluridisciplinaire **HAL**, est destinée au dépôt et à la diffusion de documents scientifiques de niveau recherche, publiés ou non, émanant des établissements d'enseignement et de recherche français ou étrangers, des laboratoires publics ou privés.

Shunted piezoelectrical flexensional suspension for vibration insulation

K. BILLON¹, N. MONTCOUDIOL¹, A. AUBRY², R. PASCUAL², F. MOSCA²,
F. JEAN², C. PEZERAT³, C. BRACAULT³, S. CHESNÉ¹

¹Univ Lyon, INSA-Lyon, CNRS UMR5259, LaMCoS, F-69621, France
simon.chesne@insa-lyon.fr

²PYTHEAS Technology, 100 Impasse des Houllières, ZA Le Pontet, F-13590, France

³Laboratoire d'Acoustique de l'Université du Mans - UMR CNRS 6613, F-72085, France

Abstract

The objective of the PyDAMP project is to develop a hybrid mechanical suspension to reduce the vibrations transmission on a wide frequency band. The undesired vibrations are generated by small electric motors (few kilograms). A suspension with piezoelectric pillar developed by PYTHEAS Technology is compared to a conventional viscoelastic suspension in terms of performances in the audible frequency range. The principle and design of the piezoelectrical suspension are approached through an electromechanical model and a finite element model. The electromechanical coupling of the transducer allows the introduction of mechanical damping and electric damping with different shunts based on resistor and negative capacitance.

1 The piezoelectrical suspension: principle and conception

The concept of suspension is inspired by a Class IV flexensionnel transducer [1, 2, 3] (figures 1). Flexensional transducers are a class of mechanical amplifiers composed of an active part, usually piezoelectric (bars, discs, rings), or magnetostrictive, and a shell that radiates in the surrounding fluid[4, 5, 6].

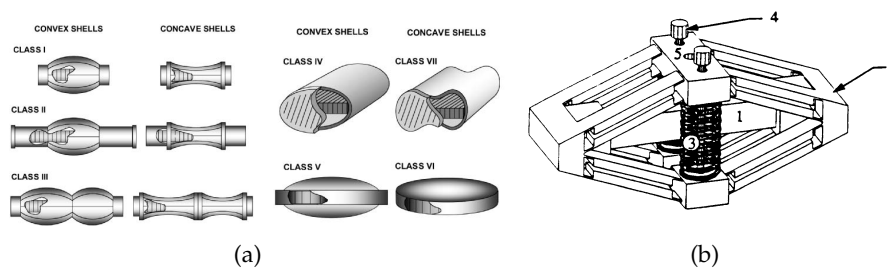

Figure 1: a) Sketch of various classes of flexensional transducers [1, 2]. b) Sketch of a Class IV flexensional piezoelectric transducer. [3]

A finite element study has been achieved to ensure the validity of the concept in terms of maximum admissible Von Mises stress, maximum displacement and modes shapes. Figure 2 shows the CAD view of the piezoelectrical suspension.

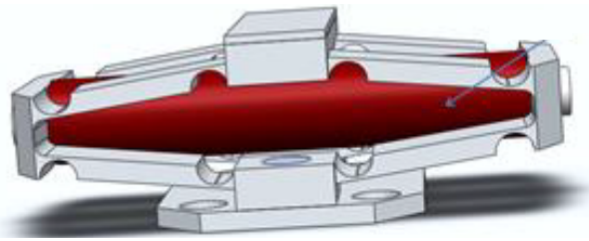

Figure 2: CAD view of the piezoelectric suspension.

2 Electrical model and simulations

An electromechanical model of the piezoelectrical suspension has been developed. Mechanical elements are converted in electrical components and an equivalent electrical circuit can be found. The simulation and the shunt optimisation are facilitated with only one physic, taking into account the whole dynamic behaviour of the piezoelectrical suspension. Figure 3 shows the schema of the piezoelectrical suspension.

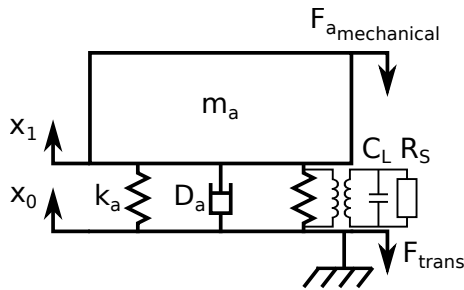

Figure 3: Schema of the piezoelectrical suspension.

The equivalent electrical circuit of the piezoelectrical suspension with mechanical excitation and resistor shunt is shown on figure 4.

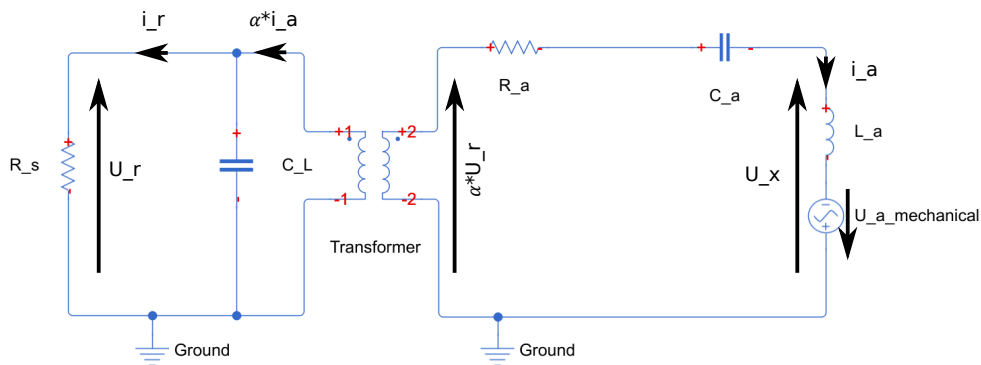

Figure 4: Equivalent electrical circuit of the piezoelectrical suspension.

Figure 5 shows the displacement transmissibility functions in open-circuited, in short-circuited conditions, with resistor shunt and with negative capacitance shunt. The damping (ζ) in open-circuited, in short-circuited conditions is similar, equal to 0.3%. As expected, the surtension is reduced by the resistor shunt, the damping (ζ) is equal to 1.6%. The negative capacitance increases the performances of the suspension to reach 2.9% of damping.

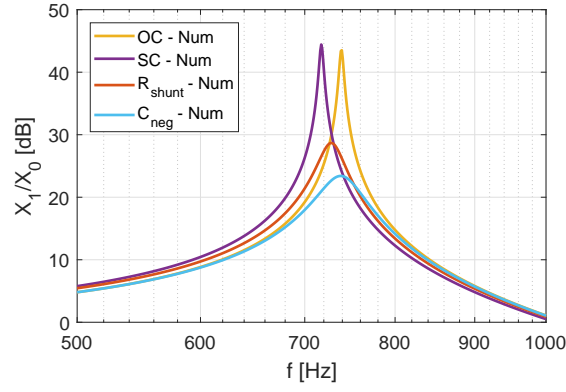

Figure 5: Transmissibility functions.

3 Comparison with a conventional viscoelastic suspension

A comparison with a conventional viscoelastic suspension is done. The conventional viscoelastic suspension is a classical spring (k_a), mass (m_a), damper (D_a). Two damping values are tested and compared with the piezoelectrical suspension namely $\zeta = 0.2\%$ and 2.9% . Figures 6 show the displacement transmissibility functions with negative capacitance shunt (blue curves) compared to conventional viscoelastic suspension with damping equal to $\zeta = 2.9\%$ (green curves) and 0.2% (black curves). Figures 6 show the comparison with equivalent damping. Differences can be observe in high frequencies from 10 kHz where the slope moves from -40 dB/dec to -20 dB/dec for the conventional viscoelastic suspension. For the piezoelectrical suspension, the change appears a decade later. For audible perturbation between 10 kHz and 20 kHz , in this case the difference is between 2 dB and 6 dB . Figures 6 show the comparison where the slope moves from -40 dB/dec to -20 dB/dec at the same frequency. Differences can be observe around 700 Hz , for the conventional suspension, the maximum transmission level is twice as high compared to the piezoelectrical suspension.

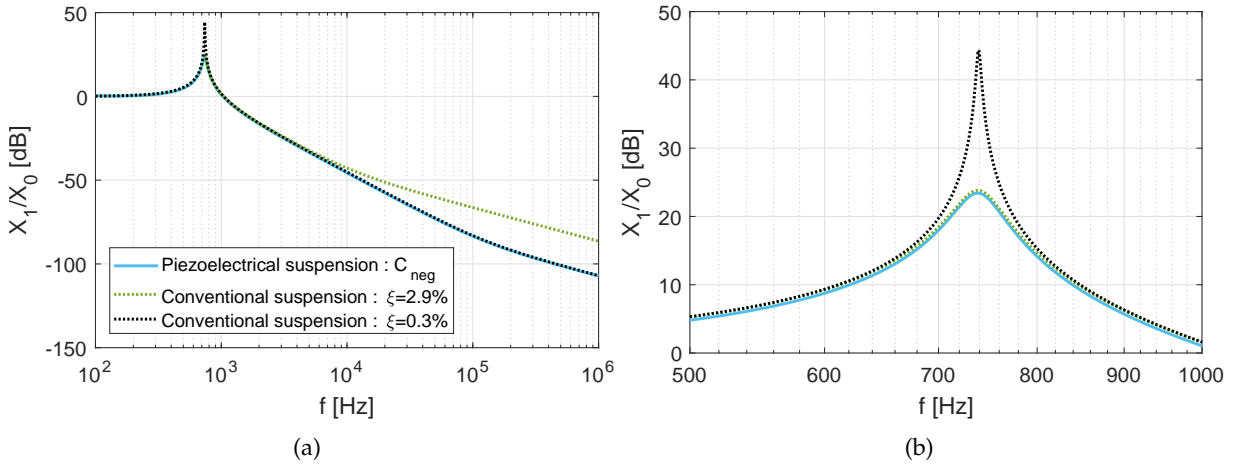

Figure 6: a) Comparison between the transmissibility functions of a conventional viscoelastic suspension and the piezoelectrical suspension. b) Zoom.

4 Experimental setup

Figure 7 shows the experimental setup. Two accelerometers are used to obtain the transmissibility functions. The mechanical excitation is provided by a shaker. The piezoelectrical suspension is glued on the shaker. Different electrical conditions can be applied on the stack. Experimental results are

under post-processing.

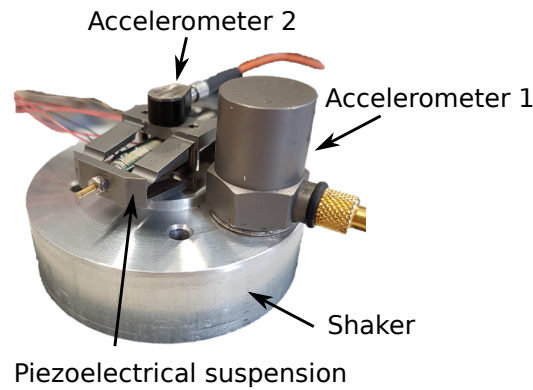

Figure 7: Experimental setup

5 Conclusion

A suspension with piezoelectric pillar developed by PYTHEAS Technology has been studied. An electromechanical model and a finite element model allowed the conception and the design of the suspension. A resistor shunt optimisation has been performed and good results were observed in order to reduce the surtension in the displacement transmissibility. Performances have been increased using a negative capacitance shunt. A comparison with conventional suspension has been conducted. For the piezoelectric suspension, no static problems are observed and there is no creep behaviour. The slope modification from -40 dB/dec to -20 dB/dec appears a decade later and is not sensitive to damping. It could be important for audible applications.

References

- [1] J. Butler and C. Sherman, *Transducers and arrays for underwater sound*, Springer, 2016.
- [2] D. Jones and N. Abboud, "Performance analysis of a low-frequency barrel-stave flextensional projector," in *Proceeding of ONR Transducer Materials and Transducers Workshop*, pp. 1–4, 1996.
- [3] N. Hagood, J. Aldrich, and A. V. Flotow, *Design of passive piezoelectric damping for space structures*, National Aeronautics and Space Administration, Langley Research Center, 1994.
- [4] B. Damiri, *Modèle analytique pour l'analyse du transducteur flextionnel de classe IV dans l'air*. PhD thesis, Lille 1, 1996.
- [5] G. Brigham and L. Royster, "Present status in the design of flextensional underwater acoustic transducers," *The Journal of the Acoustical Society of America* **46**(1A), pp. 92–92, 1969.
- [6] L. Royster, "Predicting the effective dynamic coupling coefficient of the flextensional transducer (preliminary design considerations)," *The Journal of the Acoustical Society of America* **38**(5), pp. 879–880, 1965.