



HAL
open science

Postural adjustments in anticipation of predictable perturbations allow elderly fallers to achieve a balance recovery performance equivalent to elderly non-fallers

Charlotte Le Mouel, Romain Tisserand, Thomas Robert, Romain Brette

► To cite this version:

Charlotte Le Mouel, Romain Tisserand, Thomas Robert, Romain Brette. Postural adjustments in anticipation of predictable perturbations allow elderly fallers to achieve a balance recovery performance equivalent to elderly non-fallers. *Gait & Posture*, 2019, 71, pp. 131-137. 10.1016/j.gaitpost.2019.04.025 . hal-02173060

HAL Id: hal-02173060

<https://hal.science/hal-02173060v1>

Submitted on 4 Jul 2019

HAL is a multi-disciplinary open access archive for the deposit and dissemination of scientific research documents, whether they are published or not. The documents may come from teaching and research institutions in France or abroad, or from public or private research centers.

L'archive ouverte pluridisciplinaire **HAL**, est destinée au dépôt et à la diffusion de documents scientifiques de niveau recherche, publiés ou non, émanant des établissements d'enseignement et de recherche français ou étrangers, des laboratoires publics ou privés.

Postural adjustments in anticipation of predictable perturbations allow elderly fallers to achieve a
balance recovery performance equivalent to elderly non-fallers

Charlotte Le Mouel¹, Romain Tisserand², Thomas Robert³, Romain Brette⁴

¹ corresponding author : Dr. Charlotte Le Mouel, charlotte.lemouel@normale.fr, Max Planck
Institute of Intelligent Systems, Germany

² School of Kinesiology, University of British Columbia, Vancouver, Canada

³ Laboratoire de Biomécanique et Mécanique des Chocs, Univ Lyon, Université Claude Bernard
Lyon 1, IFSTTAR, LBMC UMR_T9406, F69622, Lyon, France

⁴ Sorbonne Université, INSERM, CNRS, Institut de la Vision, France

Abstract

Background: In numerous laboratory-based perturbation experiments, differences in the balance recovery performance of elderly fallers and non-fallers are moderate or absent. This performance may be affected by the subjects adjusting their initial posture in anticipation of the perturbation.

Research questions: Do elderly fallers and non-fallers adjust their posture in anticipation of externally-imposed perturbations in a laboratory setting? How does this impact their balance recovery performance?

Methods: 21 elderly non-fallers, 18 age-matched elderly fallers and 11 young adults performed both a forward waist-pull perturbation task and a Choice Stepping Reaction Time (CSRT) task. Whole-body kinematics and ground reaction forces were recorded. For each group, we evaluated the balance recovery performance in the perturbation task, change in initial center of mass

(CoM) position between the CSRT and the perturbation task, and the influence of initial CoM position on task performance.

Results: The balance recovery performance of elderly fallers was equivalent to elderly non-fallers ($p > 0.5$ Kolmogorov-Smirnov test). All subject groups anticipated forward perturbations by shifting their CoM backward compared to the CSRT task (young: 2.1% of lower limb length, elderly non-fallers: 2.7%, elderly fallers: 2.2%, Hodges-Lehmann estimator, $p < 0.001$ Mann-Whitney U). This backward shift increases the probability of resisting the traction without taking a step.

Significance: The ability to anticipate perturbations is preserved in elderly fallers and may explain their preserved balance recovery performance in laboratory-based perturbation tasks. Therefore, future fall risk prediction studies should carefully control for this postural strategy, by interleaving perturbations of different directions for example.

Keywords: ageing; falls; anticipatory postural adjustments; balance-biomechanics

Acknowledgements and funding

CLM performed the data analysis and drafted the manuscript. RT performed the data collection and contributed with project creation. TR and RB contributed with project creation. All authors discussed the results and participated in the revision of the manuscript. Additionally, we would like to thank Vincent Ballesio for his assistance during the data collection.

This work was supported by the Fondation pour la Recherche Médicale (grant number FDT20170437383); the Ecole Normale Supérieure de Paris; and the Agence Nationale de la Recherche (EquiSim, grant number ANR-16-CE19-0006-01).

I. Introduction

With aging, there is an increasing incidence of falling (1), causing dramatic impact on health and quality of life (2). As falls may occur even in elderly adults who appear healthy (1), it remains very difficult to predict if and when an elderly person will fall. An observational study of falls in elderly people residing in long-term care identified that around a third of these falls occurred when the person failed to respond appropriately to a perturbation (following a trip, stumble, hot or bump) (3). Therefore, a major focus of research has been to characterize the balance responses of elderly fallers and non-fallers to controlled external perturbations in a laboratory environment. Although certain studies show moderate differences between elderly fallers and non-fallers (4–7) there is a surprising number of prospective studies that fail to show any difference between future fallers and non-fallers (8–11). These studies revealed marked differences between young and elderly subjects, therefore it suggests that the postural responses of elderly fallers and non-fallers to external perturbations might simply not differ under the experimental conditions. Due to the repetition of similar perturbations in controlled laboratory environments, it is possible for the subjects to anticipate essential aspects of the upcoming perturbation (direction, timing, amplitude, etc.). The ability to anticipate provides several advantages for improving the response to external perturbations which may otherwise lead to a loss of balance (12).

Our hypothesis is that elderly fallers can perform as well as elderly non-faller in certain perturbation tasks because they adjust their initial posture to the perturbation direction. Indeed, a recent theory of postural control emphasizes that subjects can use their own weight to resist an

57
58
59 external perturbation by shifting their center of mass (CoM) in the opposite direction to the
60
61 perturbation force, prior to perturbation onset (13). Knowing the direction of the perturbation in
62
63 advance is therefore a strong advantage that humans can use to improve their balance responses.
64
65 Indeed, young adults exposed to repeated backward translations of the support surface
66
67 (equivalent to a forward push applied on the CoM) gradually shift their CoM backward and
68
69 improve their ability to resist the perturbation without taking a step (14). It is however not known
70
71 whether and to what extent elderly adults adjust the position of their CoM in anticipation of
72
73 external perturbations, and how this impacts their balance performance. Although elderly adults
74
75 are able of adjusting their standing CoM position when explicitly instructed to do so, the range of
76
77 standing postures which they can adopt is more limited than young adults (15,16). This suggests
78
79 that the capacity for adjusting CoM position may be reduced in the elderly compared to the
80
81 young. However, since elderly fallers can perform as well as elderly non-fallers in certain
82
83 perturbation tasks, we hypothesize that the capacity to adjust their posture before an external
84
85 perturbation with at least partly known characteristics is preserved in elderly fallers relative to
86
87 non-fallers, attenuating the differences in balance recovery performance between these two
88
89 groups.
90
91
92
93
94

95 Young adults, elderly non-fallers and elderly fallers participated in a forward waist-pull
96
97 perturbation experiment. We quantified the balance recovery performance and determined the
98
99 initial position of the CoM adopted by the different groups. We determined the effect of
100
101 backwards leaning on task performance, with the hypothesis that leaning backwards would
102
103 improve task performance, since this allows the person to use their own weight to resist the
104
105 perturbation. For comparison with a task where leaning backward would be disadvantageous, we
106
107
108
109
110
111
112

113
114
115 also assessed the initial posture of the same subjects during a Choice Stepping Reaction Time
116 (CSRT) task (15). We then quantified the change in the subjects' initial posture between the two
117
118 tasks.
119
120
121

122 II. Methods

123 1. Protocol

124 a) Population

125
126
127
128
129
130
131
132
133
134 Eleven young (aged less than 30) and thirty-nine elderly (aged more than 70) healthy subjects
135 without neurological, musculoskeletal or sensorial disorders participated in the study. Details of
136 the exclusion criteria are provided in the Supplementary Methods (I.1). Elderly subjects
137 completed the Activities Specific Balance Confidence questionnaire (16) to estimate fear of
138 falling. Additionally, they were retrospectively classified as fallers if they had experienced at
139 least one fall in the previous year (17). Characteristics of all subjects are summarized in Table 1.
140
141
142
143
144
145
146
147
148
149
150
151
152
153
154
155
156
157
158
159
160
161
162
163
164
165
166
167
168
169
170
171
172
173
174
175
176
177
178
179
180
181
182
183
184
185
186
187
188
189
190
191
192
193
194
195
196
197
198
199
200
201
202
203
204
205
206
207
208
209
210
211
212
213
214
215
216
217
218
219
220
221
222
223
224
225
226
227
228
229
230
231
232
233
234
235
236
237
238
239
240
241
242
243
244
245
246
247
248
249
250
251
252
253
254
255
256
257
258
259
260
261
262
263
264
265
266
267
268
269
270
271
272
273
274
275
276
277
278
279
280
281
282
283
284
285
286
287
288
289
290
291
292
293
294
295
296
297
298
299
300
301
302
303
304
305
306
307
308
309
310
311
312
313
314
315
316
317
318
319
320
321
322
323
324
325
326
327
328
329
330
331
332
333
334
335
336
337
338
339
340
341
342
343
344
345
346
347
348
349
350
351
352
353
354
355
356
357
358
359
360
361
362
363
364
365
366
367
368
369
370
371
372
373
374
375
376
377
378
379
380
381
382
383
384
385
386
387
388
389
390
391
392
393
394
395
396
397
398
399
400
401
402
403
404
405
406
407
408
409
410
411
412
413
414
415
416
417
418
419
420
421
422
423
424
425
426
427
428
429
430
431
432
433
434
435
436
437
438
439
440
441
442
443
444
445
446
447
448
449
450
451
452
453
454
455
456
457
458
459
460
461
462
463
464
465
466
467
468
469
470
471
472
473
474
475
476
477
478
479
480
481
482
483
484
485
486
487
488
489
490
491
492
493
494
495
496
497
498
499
500
501
502
503
504
505
506
507
508
509
510
511
512
513
514
515
516
517
518
519
520
521
522
523
524
525
526
527
528
529
530
531
532
533
534
535
536
537
538
539
540
541
542
543
544
545
546
547
548
549
550
551
552
553
554
555
556
557
558
559
560
561
562
563
564
565
566
567
568
569
570
571
572
573
574
575
576
577
578
579
580
581
582
583
584
585
586
587
588
589
590
591
592
593
594
595
596
597
598
599
600
601
602
603
604
605
606
607
608
609
610
611
612
613
614
615
616
617
618
619
620
621
622
623
624
625
626
627
628
629
630
631
632
633
634
635
636
637
638
639
640
641
642
643
644
645
646
647
648
649
650
651
652
653
654
655
656
657
658
659
660
661
662
663
664
665
666
667
668
669
670
671
672
673
674
675
676
677
678
679
680
681
682
683
684
685
686
687
688
689
690
691
692
693
694
695
696
697
698
699
700
701
702
703
704
705
706
707
708
709
710
711
712
713
714
715
716
717
718
719
720
721
722
723
724
725
726
727
728
729
730
731
732
733
734
735
736
737
738
739
740
741
742
743
744
745
746
747
748
749
750
751
752
753
754
755
756
757
758
759
760
761
762
763
764
765
766
767
768
769
770
771
772
773
774
775
776
777
778
779
780
781
782
783
784
785
786
787
788
789
790
791
792
793
794
795
796
797
798
799
800
801
802
803
804
805
806
807
808
809
810
811
812
813
814
815
816
817
818
819
820
821
822
823
824
825
826
827
828
829
830
831
832
833
834
835
836
837
838
839
840
841
842
843
844
845
846
847
848
849
850
851
852
853
854
855
856
857
858
859
860
861
862
863
864
865
866
867
868
869
870
871
872
873
874
875
876
877
878
879
880
881
882
883
884
885
886
887
888
889
890
891
892
893
894
895
896
897
898
899
900
901
902
903
904
905
906
907
908
909
910
911
912
913
914
915
916
917
918
919
920
921
922
923
924
925
926
927
928
929
930
931
932
933
934
935
936
937
938
939
940
941
942
943
944
945
946
947
948
949
950
951
952
953
954
955
956
957
958
959
960
961
962
963
964
965
966
967
968
969
970
971
972
973
974
975
976
977
978
979
980
981
982
983
984
985
986
987
988
989
990
991
992
993
994
995
996
997
998
999
1000

153 b) Experimental setup

154
155
156
157
158 The lower limb length L of each subject was measured as the vertical distance between the great
159 trochanter and the base of the foot. The foot length was measured as the distance between the
160 heel and the longest toe. Subjects were equipped with six reflective markers on each foot, whose
161
162
163
164
165
166
167
168
169
170
171
172
173
174
175
176
177
178
179
180
181
182
183
184
185
186
187
188
189
190
191
192
193
194
195
196
197
198
199
200
201
202
203
204
205
206
207
208
209
210
211
212
213
214
215
216
217
218
219
220
221
222
223
224
225
226
227
228
229
230
231
232
233
234
235
236
237
238
239
240
241
242
243
244
245
246
247
248
249
250
251
252
253
254
255
256
257
258
259
260
261
262
263
264
265
266
267
268
269
270
271
272
273
274
275
276
277
278
279
280
281
282
283
284
285
286
287
288
289
290
291
292
293
294
295
296
297
298
299
300
301
302
303
304
305
306
307
308
309
310
311
312
313
314
315
316
317
318
319
320
321
322
323
324
325
326
327
328
329
330
331
332
333
334
335
336
337
338
339
340
341
342
343
344
345
346
347
348
349
350
351
352
353
354
355
356
357
358
359
360
361
362
363
364
365
366
367
368
369
370
371
372
373
374
375
376
377
378
379
380
381
382
383
384
385
386
387
388
389
390
391
392
393
394
395
396
397
398
399
400
401
402
403
404
405
406
407
408
409
410
411
412
413
414
415
416
417
418
419
420
421
422
423
424
425
426
427
428
429
430
431
432
433
434
435
436
437
438
439
440
441
442
443
444
445
446
447
448
449
450
451
452
453
454
455
456
457
458
459
460
461
462
463
464
465
466
467
468
469
470
471
472
473
474
475
476
477
478
479
480
481
482
483
484
485
486
487
488
489
490
491
492
493
494
495
496
497
498
499
500
501
502
503
504
505
506
507
508
509
510
511
512
513
514
515
516
517
518
519
520
521
522
523
524
525
526
527
528
529
530
531
532
533
534
535
536
537
538
539
540
541
542
543
544
545
546
547
548
549
550
551
552
553
554
555
556
557
558
559
560
561
562
563
564
565
566
567
568
569
570
571
572
573
574
575
576
577
578
579
580
581
582
583
584
585
586
587
588
589
590
591
592
593
594
595
596
597
598
599
600
601
602
603
604
605
606
607
608
609
610
611
612
613
614
615
616
617
618
619
620
621
622
623
624
625
626
627
628
629
630
631
632
633
634
635
636
637
638
639
640
641
642
643
644
645
646
647
648
649
650
651
652
653
654
655
656
657
658
659
660
661
662
663
664
665
666
667
668
669
670
671
672
673
674
675
676
677
678
679
680
681
682
683
684
685
686
687
688
689
690
691
692
693
694
695
696
697
698
699
700
701
702
703
704
705
706
707
708
709
710
711
712
713
714
715
716
717
718
719
720
721
722
723
724
725
726
727
728
729
730
731
732
733
734
735
736
737
738
739
740
741
742
743
744
745
746
747
748
749
750
751
752
753
754
755
756
757
758
759
760
761
762
763
764
765
766
767
768
769
770
771
772
773
774
775
776
777
778
779
780
781
782
783
784
785
786
787
788
789
790
791
792
793
794
795
796
797
798
799
800
801
802
803
804
805
806
807
808
809
810
811
812
813
814
815
816
817
818
819
820
821
822
823
824
825
826
827
828
829
830
831
832
833
834
835
836
837
838
839
840
841
842
843
844
845
846
847
848
849
850
851
852
853
854
855
856
857
858
859
860
861
862
863
864
865
866
867
868
869
870
871
872
873
874
875
876
877
878
879
880
881
882
883
884
885
886
887
888
889
890
891
892
893
894
895
896
897
898
899
900
901
902
903
904
905
906
907
908
909
910
911
912
913
914
915
916
917
918
919
920
921
922
923
924
925
926
927
928
929
930
931
932
933
934
935
936
937
938
939
940
941
942
943
944
945
946
947
948
949
950
951
952
953
954
955
956
957
958
959
960
961
962
963
964
965
966
967
968
969
970
971
972
973
974
975
976
977
978
979
980
981
982
983
984
985
986
987
988
989
990
991
992
993
994
995
996
997
998
999
1000

169 CA, USA) sampled at 100 Hz. We used the markers positioned on the tip of the second toe to
170
171 determine the forwards edge of the foot at trial onset. To estimate the balance performance in
172
173 perturbation trials, we used the trajectory of the fifth metatarsal joint markers, because they were
174
175 never masked from the camera after perturbation onset. Four force platforms (60 cm × 40 cm,
176
177 Bertec^(R), OH, USA) were used to record ground reaction forces and torques sampled at 1000 Hz.
178
179 All subjects performed the CSRT task first, and then the perturbation task. For each trial,
180
181 subjects initially stood quietly with one foot on each of the two back platforms (Figure 1, A-B).
182
183
184
185
186
187

188 The protocol and results of the CSRT are published elsewhere (15). Briefly, four stepping targets
189
190 and four corresponding light-emitting diodes (LED) were placed in front of the subject (Figure
191
192 1.A). Subjects were instructed to: “place [their] corresponding foot as fast as possible onto the
193
194 corresponding target indicated by the LED.” Leftwards targets (red and orange) were to be
195
196 stepped on with the left foot, and rightwards targets (yellow and green) with the right foot. Each
197
198 subject performed one block of 16 trials, with each target presented four times, in random order.
199
200 Trials in which the subject appeared to hesitate for a long while, or in which the subject stepped
201
202 with the wrong foot, were repeated at the end of the initial sequence of 16 trials.
203
204
205
206

207 In the perturbation task, subjects wore a safety harness to prevent injury in case of a fall. Three
208
209 cables were attached to the harness at waist level. Each cable could pull the person either straight
210
211 forward or laterally at an angle of 30° (Figure 1.B, upper panel). On any given trial, one of the
212
213 three cables was attached to a rotating motor which, after a random waiting period between 1 and
214
215 12 seconds, applied a force controlled in amplitude and duration. The applied force was either
216
217 “short” (200 ms duration with a peak amplitude of 27% of the subject’s weight, brown curve in
218
219
220
221
222
223
224

225
226
227 Figure 1.B, lower panel), or “long” (1000 ms duration with a peak amplitude of 14% of the
228 subject’s weight, orange curve). The integral of the force applied during the long perturbation
229 was 91% larger than the integral of the short perturbation. To avoid any whipping effect when
230 stretching the cable, an initial pretension was applied by the rotating motor before perturbation
231 onset. The two other cables were stretched by small mass equivalent to the pre-tension force
232 attached to their end, resulting in a total pretension of 3.5% of the subject’s body weight.
233
234 Additional details can be found in the Supplementary Methods (I.2). Subjects were instructed to
235 “recover balance as fast as possible and in the shortest possible distance”. Elderly subjects
236 performed 18 trials, with each of the six perturbations (three directions, two amplitudes)
237 presented three times, in random order. Young subjects performed 24 trials, with each
238 perturbation presented four times, in random order.
239
240
241
242
243
244
245
246
247
248
249

250 251 2. Analysis 252

253 254 255 a) Performance in perturbation trials 256 257 258 259

260 Performance was assessed by the distance between the initial foot position and the final foot
261 position, measured once a steady balance was recovered. The shorter the distance, the better the
262 task success. For comparison across subjects, this distance was normalized to the subject's lower
263 limb length. The position of the fifth metatarsal joint of each foot was used to indicate foot
264 position (error of measurement < 1 mm, i.e. 0.1% limb length). This method is illustrated in the
265
266
267
268
269
270
271 Supplementary Methods (II.1)
272
273
274
275
276
277
278
279
280

281
282
283 The distribution of performance distances was bimodal (Figure 2.A-D), and in trials for which
284 this distance was inferior to 8% of the person's lower limb length, it was considered that the
285 subject did not step (non-step trial).
286
287
288

289 We then analyzed two variables: the frequency of non-step trials, and the performance distance
290 in which the subject took at least one step (step trials).
291
292
293

294 295 296 b) Initial posture preceding stimulus onset 297

298
299 We determined the subject's posture in the 500 ms preceding the onset of the LED in the CSRT
300 task, and in the 500 ms preceding the onset of the perturbation in the perturbation task. During
301 this waiting period, the subject is in quasi-static standing posture, therefore the torques acting
302 upon the body cancel each other out. The horizontal distance between the CoM and the center of
303 pressure (CoP) is determined by the torque of the external forces acting on the body other than
304 weight and the ground reaction force (13). The position of these points within the feet remains
305 however free, allowing subjects to adopt different initial postures. We determined the front of the
306 feet as the mid-point between the markers on the toes of the left and right feet. We then used the
307 forceplates to determine the antero-posterior positions of the CoP and CoM relative to the front
308 of the feet, x_{CoP} and x_{CoM} .
309
310
311
312
313
314
315
316
317
318
319
320
321
322

323
324 In the perturbation task, because an initial pretension was applied by the cables to the subject in
325 the forward direction, the CoM was positioned backward of the CoP (Figure 1.C, left panel).
326
327

328 This pretension was assumed to be applied horizontally, at a height equal to the subject's lower
329
330
331
332
333
334
335
336

337
338
339 limb length L . Its amplitude was assumed to be on average opposite to the mean anteroposterior
340
341 ground reaction force (F_x) measured by the forceplates. The sum of torques is then:
342

$$343 \quad L F_x + M.g (x_{CoP} - x_{CoM})$$

344
345 Where $M.g$ is the person's weight, defined as the mean vertical ground reaction force during the
346
347 waiting periods in the CSRT task. We assumed that the sum of torques was on average null
348
349 during each waiting period to determine x_{CoM} from x_{CoP} and F_x . To adequately compare the
350
351 initial postures measured in the CSRT and perturbation tasks, the same method was used to
352
353 determine x_{CoM} in the CSRT task.
354
355

356
357 The perturbation amplitude was scaled to the subject's weight, therefore its torque was
358
359 proportional to $L M g$. To compare torques across subjects, we normalized x_{CoM} by the subject's
360
361 lower limb length, rather than by the subject's foot length as is commonly done (18,19). This
362
363 method is illustrated in the Supplementary Methods (II.1).
364
365

366 367 c) Error of measurement

368
369
370
371
372 The error of measurement of x_{CoM}/L is the sum of the error of measurement of the positions of
373
374 the toe markers, and of the error due to the force platform measurement. The former may have a
375
376 constant bias in case the markers are not accurately positioned on the anatomical landmarks. It
377
378 additionally has a variable noise component due to the error of measurement of the motion
379
380 capture device, which is inferior to 1 mm, i.e. 0.1% limb length. The latter may have a constant
381
382 bias due to the calibration of the force platforms, and has a variable noise component due to slow
383
384 changes in posture which were estimated to be inferior to 0.2% of lower limb length (see
385
386 Supplementary Methods II.2). When considering differences in x_{CoM}/L between two trials of a
387
388
389
390
391
392

393
394
395 given subject, the constant biases cancel out. The error of measurement for differences in posture
396
397 is therefore only affected by the variable noise components, estimated to be inferior to 0.3% of
398
399 lower limb length per trial. To report differences in posture between two samples of size n_1 and
400
401 n_2 , we indicated the standard error of the mean as $0.3\% \sqrt{\frac{1}{n_1} + \frac{1}{n_2}}$.
402
403
404

405 The error in measurement of the distance required to recover balance is only due to the noise in
406
407 the marker positions (inferior to 0.1% limb length). When reporting differences in balance
408
409 performance, we used $0.1\% \sqrt{\frac{1}{n_1} + \frac{1}{n_2}}$.
410
411
412
413
414

415 3. Statistical analysis 416

417
418
419 The 2-proportion z-test was used to compare the proportion of non-step trials across subject
420
421 groups and across perturbations.
422
423
424
425

426 The distribution of performance distances for trials with at least one step is non-Gaussian (Figure
427
428 2.A-D, the distributions are not symmetric around their mean but are instead skewed to the
429
430 right). We therefore used the non-parametric Mann-Whitney U-test to compare differences
431
432 between the medians of continuous distributions. It was first used to compare the median
433
434 performance in the perturbation task across subject groups and across perturbations. It was then
435
436 used to compare the median initial x_{CoM} between the CSRT task and the perturbation task, within
437
438 each subject group. Finally, it was used to compare the median initial x_{CoM} for perturbation trials
439
440 with and without steps, within each subject group.
441
442
443
444
445
446
447
448

449
450
451 When a statistical difference between two medians was found, this difference was estimated
452
453 using the Hodges-Lehmann estimator.
454
455

456
457
458 When no statistical difference between two medians was found, as for instance in the balance
459
460 performance of elderly fallers and non-fallers in the perturbation task for each perturbation
461
462 amplitudes, then a Kolmogorov-Smirnov test was used to determine whether there was any
463
464 difference in the distributions.
465

466 For each elderly subject, the Hodges-Lehmann estimator was used to estimate the subject's
467
468 change in x_{CoM} between the CSRT and the perturbation task. A linear regression was used to
469
470 determine whether this change was correlated to fear of falling within fallers, within non-fallers,
471
472 and across elderly subjects.
473
474

475
476
477 Additional details can be found in the Supplementary Methods (II.3).
478
479

480 III. Results 481 482

483 484 1. Balance performance in the perturbation task 485 486 487

488 The distribution of the distances required to recover balance is illustrated in Figure 2.A-D for
489
490 each group and the two perturbations. In trials with at least one step, this distance was 33% of
491
492 lower limb length for elderly non-fallers and 34% for elderly fallers (short perturbation) and 50%
493
494 for both elderly non-fallers and fallers (long perturbation). We found no significant difference
495
496 between the performance of the elderly fallers (red) and elderly non-fallers (blue), regardless of
497
498 the perturbation ($p > 0.5$ for both short and long perturbations).
499
500
501
502
503
504

505
506
507
508
509 Elderly fallers and non-fallers were pooled together (purple trace) and compared to young
510 subjects (green). For young subjects, the distance required to stop was 43% of lower limb length
511 for both short and long perturbations. For short perturbations (Figure 2.C), this distance was
512 significantly larger than for elderly subjects ($p < 0.001$) by $9.3\% \pm 0.01\%$ of lower limb length.
513
514 For long perturbations (Figure 2.D), this distance was significantly smaller than for elderly
515 subjects ($p < 0.001$) by $5.4\% \pm 0.01\%$ of lower limb length.
516
517
518
519
520
521
522
523

524 Across all subjects, the proportion of non-step trials was significantly larger for short compared
525 to long perturbations ($p < 0.001$, see Figure 2.E). Within each perturbation type, the proportion
526 of non-step trial was slightly smaller for young compared to elderly but this difference was not
527 significant. No difference was observed between elderly fallers and elderly non-fallers ($p > 0.1$).
528
529
530
531
532
533

534 2. Change in posture across tasks

535
536
537
538
539 The distribution of distances between the initial CoM position and the forward edge of the feet
540 for each group and both tasks is presented in Figure 3. For the perturbation task, the median
541 initial distance across all subjects was on average 17.5% of the subject's lower limb length, with
542 no significant differences between groups ($p > 0.1$). For the CRST task, the median distance was
543 15.4% of the person's lower limb length. This distance was slightly smaller in non-fallers
544 (15.2%), compared to fallers (16.0%, $p < 0.01$) and young adults (15.7%, $p < 0.05$). No
545 significant difference was found between young adults and elderly fallers ($p > 0.5$).
546
547
548
549
550
551
552
553
554
555
556
557
558
559
560

561
562
563 All groups of subjects shifted their CoM backward in the perturbation task compared to the
564
565 CSRT task (young: $p < 0.001$, non-fallers : $p < 0.001$, fallers : $p < 0.001$). This backward shift is
566
567 of $1.8\% \pm 0.03\%$ of lower limb length for the young adults (Figure 3.A), $2.5\% \pm 0.02\%$ for the
568
569 elderly non-fallers (Figure 3.B) and $2.0\% \pm 0.02\%$ for the elderly fallers (Figure 3.C). To provide
570
571 values comparable with previous studies, we also reported the results in % foot length (Table 2).
572
573

574
575
576 Fear of falling was significantly higher (i.e. a smaller Balance confidence score) in the elderly
577
578 fallers compared to elderly non-fallers ($p < 0.001$). However, at an individual level, the change in
579
580 posture across tasks was not correlated with fear of falling (elderly fallers: $p > 0.3$, elderly non-
581
582 fallers: $p > 0.7$).
583
584

585 586 3. Influence of initial posture on balance performance in the perturbation task 587 588

589
590
591 To quantify the effect of the initial posture on balance performance, the initial CoM positions in
592
593 trials with and without steps were compared (Figure 4). Across trials, the initial CoM positions
594
595 ranged from 11.2 to 23.6 % of lower limb length (37.9 to 82.6 % of foot length), whereas in trials
596
597 without steps, subjects leaned backwards by at least 15 % of lower limb length (56 % of foot
598
599 length). All groups of subjects had a more backward initial CoM position in non-step trials
600
601 compared to trials with at least one step (young adults: $p < 0.01$, Figure 4.A; elderly non-fallers :
602
603 $p = 0.01$, Figure 4.B; elderly fallers : $p < 0.01$, Figure 4.C). This difference is of $2.8\% \pm 0.07\%$ of
604
605 lower limb length for the young adults, $0.7\% \pm 0.05\%$ for the elderly non-fallers and $2.3\% \pm$
606
607 0.05% for the elderly fallers. Results in % of foot length are indicated in Table 2.
608
609
610
611
612
613
614
615
616

617
618
619
620
621
622 IV. Discussion
623
624
625
626

627 When exposed to repeated waist-pull perturbations with a predictable dominant forward
628 component, elderly fallers performed as well as elderly non-fallers in terms of distance required
629 to recover balance. This occurred although the perturbation timing, amplitude, duration and
630 lateral direction were not predictable. The absence of difference between the fallers and non-
631 fallers is unlikely to be due only to an inappropriate classification based on a single fall event,
632 because our group of elderly fallers displayed higher fear of falling (Table 1) and reduced
633 performance in the CSRT task (15). Therefore, our study completes the list of studies which have
634 failed to reveal differences in the balance responses between elderly fallers and non-fallers to
635 externally-triggered perturbations in a laboratory setting (8–11).
636
637
638
639
640
641
642
643
644
645
646

647
648 As in previous laboratory-based perturbation experiments (3), our study revealed differences in
649 balance performance between young and elderly subjects. Young subjects required the same
650 distance to recover balance for both short and long perturbations, although the summed torque
651 induced by the long perturbation was almost twice as large as for the short perturbation. Elderly
652 subjects on the other hand had a more graded response to the perturbation momentum, and
653 required a longer distance to recover balance following the long perturbation than following the
654 short. This suggests that young subjects always trigger the same step (7), regardless of the
655 perturbation momentum. This strategy may be generally effective to recover balance, however
656 for short perturbations it seems to overestimate the necessary step length, as elderly subjects are
657 able to recover balance with shorter distances than young subjects.
658
659
660
661
662
663
664
665
666
667
668
669
670
671
672

673
674
675
676
677 In the perturbation protocol used in this study, subjects must produce a backward torque to
678
679 compensate for the forward torque induced by the pulling cable. This aspect probably appeared
680
681 very clearly to each subject as soon as the three cables were attached to the harness. The
682
683 biomechanical action required to produce a backward torque is a shift of the CoP in front of the
684
685 CoM. However, the CoP cannot be brought further forward than the toes. Therefore, if the
686
687 person's feet remain stationary, the maximal backward torque which they can exert is
688
689 proportional to the distance between their initial CoM position and their toes. Shifting the CoM
690
691 backward before the onset of the perturbation increases this distance, thereby increasing the
692
693 potential backward torque needed to resist the perturbation after its onset. This biomechanical
694
695 requirement explains why we observed a more backward position of the CoM in all subject
696
697 groups in the perturbation task relative to the CSRT task (Figure 3).
698
699
700
701

702
703 Relative to the natural CoM position adopted in quiet standing, young adults can shift their CoM
704
705 backwards by up to 20 % of foot length, whereas this distance is reduced to 15 % of foot length
706
707 in elderly subjects (18,19). In the perturbation task of our study, young subjects shifted their
708
709 CoM backwards prior to the perturbation onset by 6.7% of their foot length, elderly non-fallers
710
711 by 8.9 %, and fallers by 7.6%, (Table 2). For elderly subjects this postural shift corresponds to
712
713 half of their available range. Interestingly, this backwards shift was not correlated to fear of
714
715 falling.
716
717

718
719
720 Shifting the CoM backward prior to an external perturbation is important for resisting the
721
722 traction (13) and increases the chances to recover balance without taking a step. In our
723
724
725
726
727
728

729
730
731 experiment, subjects were instructed to recover balance in the shortest possible distance.
732

733 Therefore, recovering balance without taking a step was the best possible response. Our results
734 show that initially positioning the CoM further backward increases the proportion of non-
735 stepping trials in all groups of subjects (Figure 4). Trials without steps only occurred when the
736 initial CoM position relative to the toes was larger than 56% of foot length. In quiet standing,
737 young subjects can adopt quiet standing postures with a CoM position relative to the toes ranging
738 from 16.8 % to 76.8 % of foot length, whereas for elderly subjects quiet standing postures range
739 from 29.5 % to 69.5 % (18). The possibility of resisting the traction without taking a step thus
740 requires that subjects initially stand with their CoM relatively close to the backwards edge of
741 their base of support.
742
743
744
745
746
747
748
749
750
751

752
753
754 Our study demonstrates an anticipatory shift of CoM position preceding perturbation onset when
755 the perturbation direction can be anticipated. This shift was performed by both elderly fallers and
756 non-fallers and helped them to recover balance equally well. Previous studies have demonstrated
757 that anticipatory postural adjustments occur at the initiation of a voluntary movement, such as
758 walking (20) or stepping forwards (15). These adjustments create the necessary momentum to
759 propel the CoM in the direction of the intended movement. For a forwards movement, this is
760 achieved through a backward shift of the CoP after the cue for movement initiation. This CoP
761 shift is of smaller amplitude in the elderly relative to the young (20), and in elderly fallers
762 relative to non-fallers (15), resulting in a slower CoM movement. We thus suggest the ability for
763 slow CoM shifts is preserved in elderly fallers and that what is crucially affected is their ability
764 to rapidly shift the CoM to compensate quickly for a perturbation. Thus, in our perturbation task,
765 subjects are given as much time as they want to prepare for the upcoming perturbation. This task
766
767
768
769
770
771
772
773
774
775
776
777
778
779
780
781
782
783
784

785
786
787 therefore does not probe how fast the subjects can shift their posture, and reveals no difference in
788
789 performance between fallers and non-fallers. In the CSRT task on the contrary, the subjects do
790
791 not know with which foot they should step. When the target lights up, they must first shift their
792
793 weight forward and also onto the stance foot before raising the swing foot. This task probes how
794
795 fast the subjects can shift their CoM, and elderly fallers perform this task more slowly than
796
797 elderly non-fallers (15,21). Finally, “incorrect weight shifting”, accounts for 41% of the falls
798
799 occurring in a nursing home residence (3). Thus, the ability to perform rapid and accurate shifts
800
801 of their own CoM position appears to be critical in order to identify a potential risk of falling.
802
803

804
805
806 According to our results, future studies aiming to predict fall risk in the elderly should be
807
808 designed to probe the response of the subject to perturbations of unexpected characteristics,
809
810 including direction. Forward and backward (or leftward and rightward) perturbations should
811
812 therefore be interleaved in a random manner, to prevent subjects from anticipating on
813
814 perturbation direction. Thus, a prospective study using waist-pull perturbations in 12 directions
815
816 revealed differences between future fallers and non-fallers (7). This may be closer to ecological
817
818 situations where an elderly person encounters an unexpected perturbation requiring a fast
819
820 postural shift, thus providing a better assessment of fall risk.
821
822

823 824 825 826 V. Conflict of interest statement

827
828 There are no conflicts of interest.
829
830

831 832 VI. References

- 833
834
835
836 1. Masud T, Morris RO. Epidemiology of falls. *Age Ageing*. 2001;30 Suppl 4:3-7.
837
838
839
840

- 841
842
843
844
845
846
847
848
849
850
851
852
853
854
855
856
857
858
859
860
861
862
863
864
865
866
867
868
869
870
871
872
873
874
875
876
877
878
879
880
881
882
883
884
885
886
887
888
889
890
891
892
893
894
895
896
2. Gill TM, Murphy TE, Gahbauer EA, Allore HG. Association of Injurious Falls With Disability Outcomes and Nursing Home Admissions in Community-Living Older Persons. *Am J Epidemiol.* 2013;178(3):418-425.
 3. Robinovitch SN, Feldman F, Yang Y, et al. Video capture of the circumstances of falls in elderly people residing in long-term care: an observational study. *Lancet.* 2013;381(9860):47-54.
 4. Wolfson LI, Whipple R, Amerman P, Kleinberg A. Stressing the postural response. A quantitative method for testing balance. *J Am Geriatr Soc.* 1986;34(12):845-850.
 5. Chandler JM, Duncan PW, Studenski SA. Balance performance on the postural stress test: comparison of young adults, healthy elderly, and fallers. *Phys Ther.* 1990;70(7):410-415.
 6. Studenski S, Duncan PW, Chandler J. Postural responses and effector factors in persons with unexplained falls: results and methodologic issues. *J Am Geriatr Soc.* 1991;39(3):229-234.
 7. Mille M-L, Johnson-Hilliard M, Martinez KM, Zhang Y, Edwards BJ, Rogers MW. One Step, Two Steps, Three Steps More ... Directional Vulnerability to Falls in Community-Dwelling Older People. *J Gerontol A Biol Sci Med Sci.* 2013;68(12):1540-1548.
 8. Baloh RW, Corona S, Jacobson KM, Enrietto JA, Bell T. A Prospective Study of Posturography in Normal Older People. *Journal of the American Geriatrics Society.* 1998;46(4):438-443.
 9. Hill K, Schwarz J, Flicker L, Carroll S. Falls among healthy, community-dwelling, older women: a prospective study of frequency, circumstances, consequences and prediction accuracy. *Australian and New Zealand Journal of Public Health.* 1999;23(1):41-48.
 10. Kario K, Tobin JN, Wolfson LI, et al. Lower standing systolic blood pressure as a predictor of falls in the elderly: a community-based prospective study. *Journal of the American College of Cardiology.* 2001;38(1):246-252.
 11. Maki BE, Holliday PJ, Topper AK. A Prospective Study of Postural Balance and Risk of Falling in An Ambulatory and Independent Elderly Population. *J Gerontol.* 1994;49(2):M72-M84. doi:10.1093/geronj/49.2.M72.
 12. Dakin CJ, Bolton DAE. Forecast or Fall: Prediction's Importance to Postural Control. *Front Neurol.* 2018;9. doi:10.3389/fneur.2018.00924.
 13. Le Mouel C, Brette R. Mobility as the Purpose of Postural Control. *Front Comput Neurosci.* 2017;11:67.
 14. Welch TDJ, Ting LH. Mechanisms of Motor Adaptation in Reactive Balance Control. *PLOS ONE.* 2014;9(5):e96440.

- 897
898
899
900
901
902
903
904
905
906
907
908
909
910
911
912
913
914
915
916
917
918
919
920
921
922
923
924
925
926
927
928
929
930
931
932
933
934
935
936
937
938
939
940
941
942
943
944
945
946
947
948
949
950
951
952
15. Tisserand R, Robert T, Chabaud P, Bonnefoy M, Chèze L. Elderly Fallers Enhance Dynamic Stability Through Anticipatory Postural Adjustments during a Choice Stepping Reaction Time. *Front Hum Neurosci.* 2016;10:613.
 16. Powell LE, Myers AM. The Activities-specific Balance Confidence (ABC) Scale. *J Gerontol A Biol Sci Med Sci.* 1995;50A(1):M28-34.
 17. Tinetti ME, Speechley M, Ginter SF. Risk factors for falls among elderly persons living in the community. *N Engl J Med.* 1988;319(26):1701-1707.
 18. Schieppati M, Hugon M, Grasso M, Nardone A, Galante M. The limits of equilibrium in young and elderly normal subjects and in parkinsonians. *Electroencephalogr Clin Neurophysiol.* 1994;93(4):286-298.
 19. King MB, Judge JO, Wolfson L. Functional base of support decreases with age. *J Gerontol.* 1994;49(6):M258-263.
 20. Halliday S, Winter D, Frank J, Patla A, Prince F. The initiation of gait in young, elderly, and Parkinson's disease subjects. *Gait Posture.* 1998;8(1):8-14.
 21. Lord SR, Fitzpatrick RC. Choice Stepping Reaction Time: A Composite Measure of Falls Risk in Older People. *The Journals of Gerontology Series A: Biological Sciences and Medical Sciences.* 2001;56(10):M627-M632.

953
954
955
956
957
958 VII. Figure legends
959
960
961

962 Figure 1 Methods. A.-B Protocol: the subject initially stands with one foot on each of the two
963 back force platforms out of four (blue). A. In the Choice Stepping Reaction Time task, four
964 stepping targets are placed in front of the subject at a distance of 40% of the subject's lower limb
965 length. Two of these targets are located centrally (yellow and orange), and the two others are
966 located laterally, at an angle of 30° (red and green). Four light-emitting diodes (LED),
967 corresponding to the four targets, are placed in front of the subject to indicate on which target the
968 subject should step. B. (Upper) In the perturbation task, three cables are attached to the subject's
969 harness at waist level and, on any given trial, only one of these cables is attached to a motor
970 hidden behind a screen. (Lower). The perturbation is proportional to the subject's weight and is
971 either short (brown) or long (yellow). C. The person is assumed to be in a quasi-static posture
972 before trial onset. For the perturbation task (left), due to the initial pre-tension (black arrow), the
973 CoM (blue dot) is backward of the CoP (red dot). For the CSRT task (right), the CoM and CoP
974 are aligned.
975
976
977
978
979
980
981
982
983
984
985
986
987
988
989
990
991

992 Figure 2 Performance in the perturbation task. Graphs show the normalized distribution of
993 distance required to stop the motion triggered by the perturbation, normalized to the subject's
994 lower limb length, for short (A, C) and long (B, D) perturbations. In panels A. and B., elderly
995 non-fallers are shown in blue and elderly fallers in red. In panels C. and D., elderly fallers and
996 non-fallers are pooled (purple), for comparison with the young subjects (green). For each group
997 and perturbation duration, the median distance is indicated as a triangle on the top of the graph.
998
999
1000
1001
1002
1003
1004
1005
1006
1007
1008

1009
1010
1011 E. Proportion of non-step trials for short (brown) and long (orange) perturbations; error bars
1012 indicate the standard error on the estimation of this proportion (additional details are provided in
1013 the Supplementary Methods I.3). Statistically different results are indicated as a star.
1014
1015
1016
1017
1018

1019
1020 Figure 3 Change in posture across tasks. Graphs show the normalized distribution of the initial
1021 position of the CoM backward of the toes as % of lower limb length, in the perturbation task
1022 (red) and in the CSRT task (black), for young subjects (A), elderly non-fallers (B) and elderly
1023 fallers (C). For each group and task, the median CoM position is indicated as a triangle on the
1024 top of the graph. Statistically different results are indicated as a star.
1025
1026
1027
1028
1029
1030

1031
1032 Figure 4 Influence of posture on balance performance. Graphs show the normalized distribution
1033 of the initial CoM position in the perturbation task for trials in which the subjects took a step
1034 (purple) and for trials in which the subjects did not step (pink), for young subjects (A), elderly
1035 non-fallers (B) and elderly fallers (C). For each group and condition, the median CoM position is
1036 indicated as a triangle on top of the graph. Statistically different results are indicated as a star.
1037
1038
1039
1040
1041
1042
1043
1044
1045
1046
1047
1048
1049
1050
1051
1052
1053
1054
1055
1056
1057
1058
1059
1060
1061
1062
1063
1064

A. Stepping task

Target instruction:

LED signal



Targets
40%
lower
limb
length

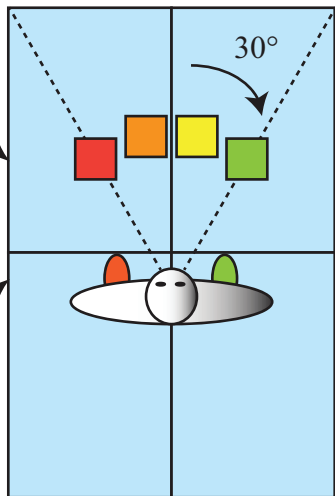

B. Waist-pull perturbation

Motor

Screen

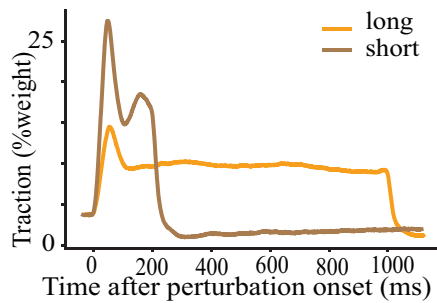
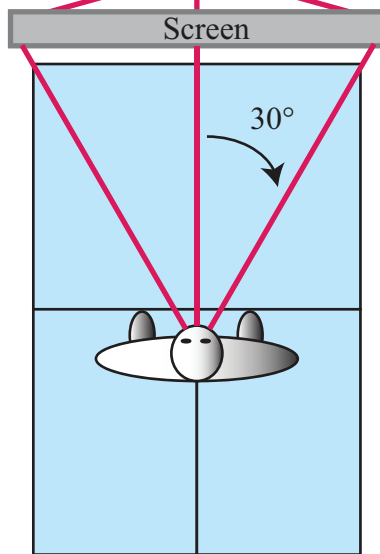

C. Determination of CoM position

Perturbation task

Stepping task

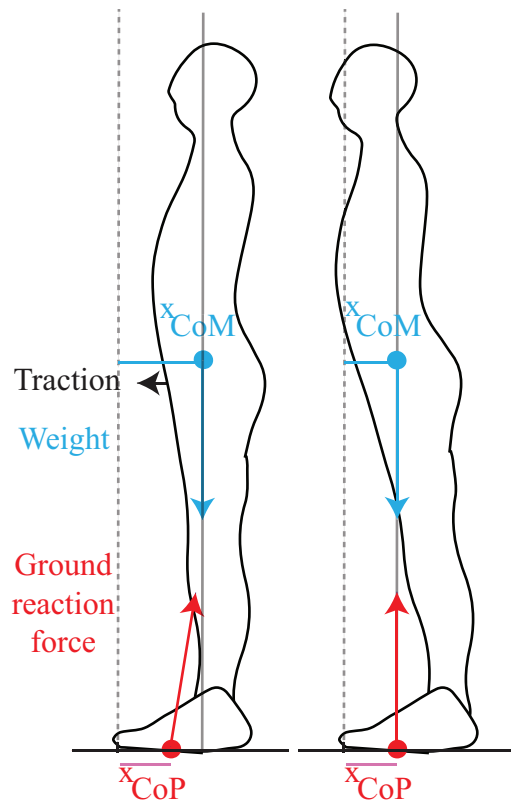

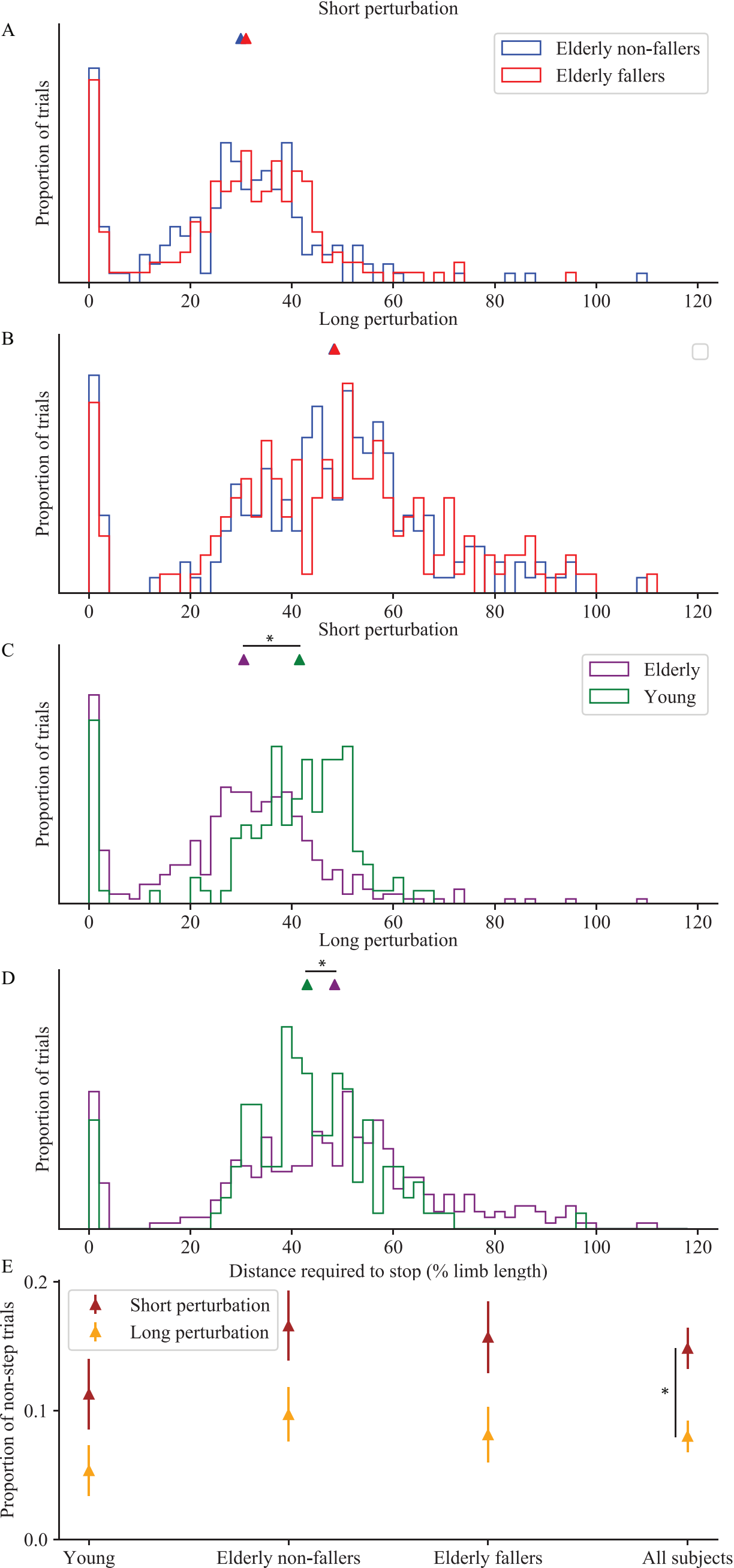

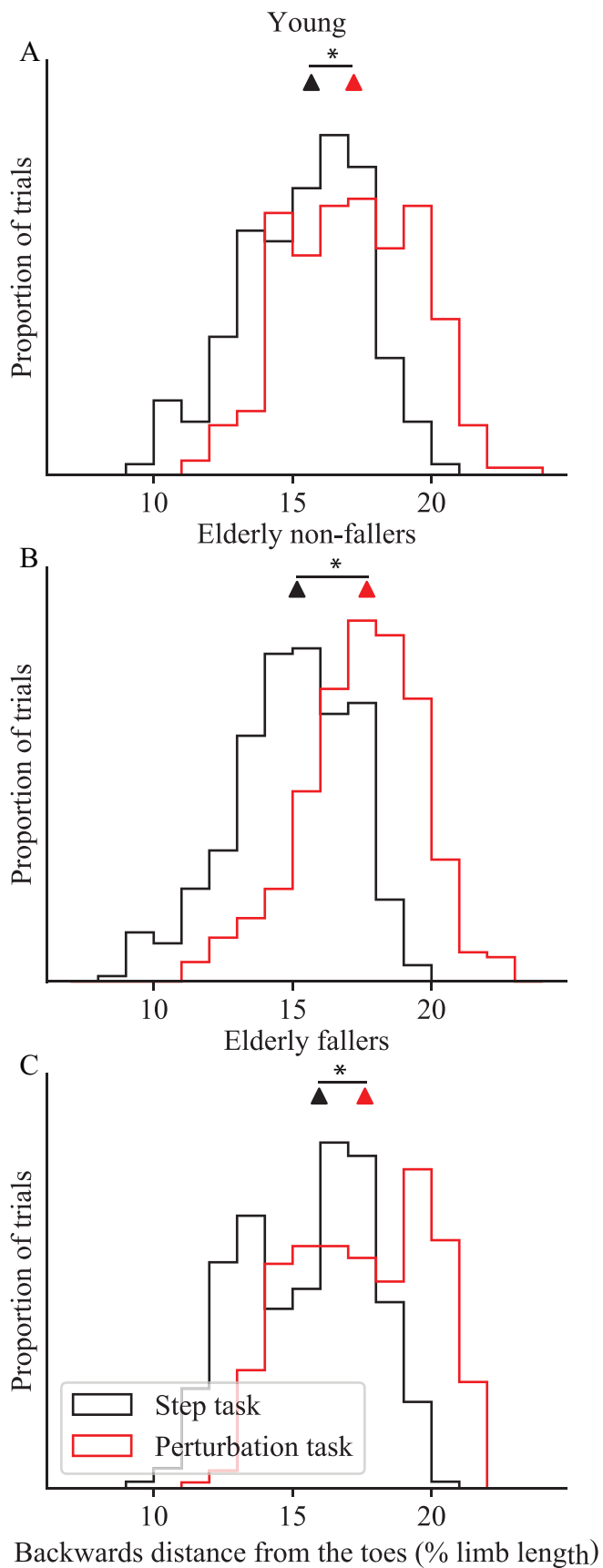

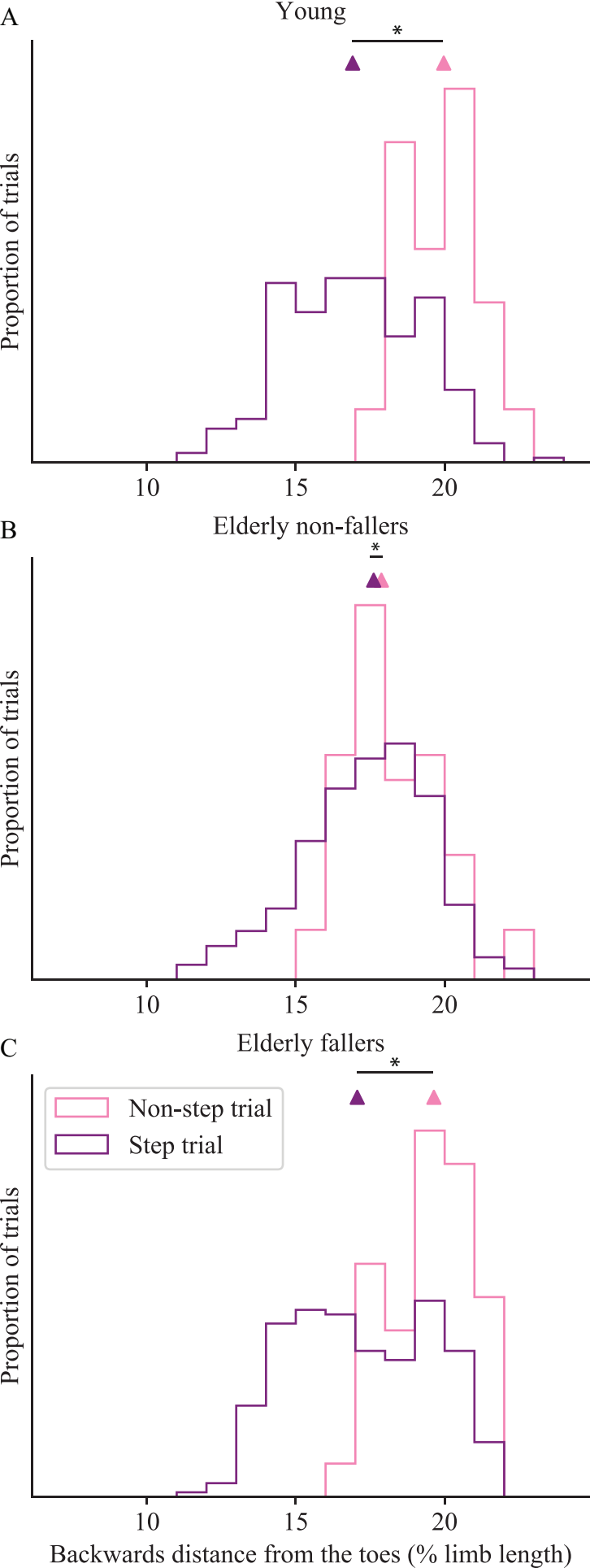

Table 1 Characteristics of the subjects

		Young	Elderly non-fallers	Elderly fallers
	Number of subjects	11	21	18
	Number of women	5	13	14
Age (years)	Mean	25	74	75
	Range	22 - 27	69 - 83	70 – 82
Mass (kg)	Mean	69	67	70
	Range	59 – 85	49 – 98	55 – 95
Height (m)	Mean	1.70	1.63	1.61
	Range	1.62 – 1.84	1.51 – 1.86	1.46 – 1.90
Lower limb length (m)	Mean	0.90	0.89	0.87
	Range	0.84 – 1.00	0.81 – 1.04	0.75 – 1.00
Foot length (% limb length)	Mean	27.2 %	28.0 %	27.8 %
	Range	24.5–29.1 %	26.6-30.9%	25.6-31.1%
Balance confidence (score out of 100)	Mean	Not	91.5	76.8
	Range	Tested	74 - 100	58 - 92
Number of trials	CSRT task	176	342	295
	Perturbation task	264	383	332
	of which trials without steps	22	50	40

Table 2 Difference in initial CoM position relative to the toes

	In the perturbation task relative to the CSRT task		In perturbation trials with steps relative to trials without steps	
	% limb length	% foot length	% limb length	% foot length
Young	1.8 (p < 0.001)	6.7 (p < 0.001)	2.8 (p < 0.001)	7.2 (p < 0.001)
Elderly non-fallers	2.5 (p < 0.001)	8.9 (p < 0.001)	0.7 (p = 0.01)	3.0 (p < 0.001)
Elderly fallers	2.0 (p < 0.001)	7.6 (p < 0.001)	2.3 (p < 0.001)	10.9 (p < 0.001)