



HAL
open science

Prediction of Adhesion Failure of Bonded Joints using 3-Point Bending Test and Stress-Energy Coupled Criterion

Thiago Birro, Maëlen Aufray, Eric Paroissien, Frederic Lachaud

► **To cite this version:**

Thiago Birro, Maëlen Aufray, Eric Paroissien, Frederic Lachaud. Prediction of Adhesion Failure of Bonded Joints using 3-Point Bending Test and Stress-Energy Coupled Criterion. 12th European Adhesion Conference (EURADH), Sep 2018, Lisbon, Portugal. Proceedings of the 12th European Adhesion Conference (EURADH), pp.1-1, 2018. hal-02153745

HAL Id: hal-02153745

<https://hal.science/hal-02153745>

Submitted on 12 Jun 2019

HAL is a multi-disciplinary open access archive for the deposit and dissemination of scientific research documents, whether they are published or not. The documents may come from teaching and research institutions in France or abroad, or from public or private research centers.

L'archive ouverte pluridisciplinaire **HAL**, est destinée au dépôt et à la diffusion de documents scientifiques de niveau recherche, publiés ou non, émanant des établissements d'enseignement et de recherche français ou étrangers, des laboratoires publics ou privés.



Open Archive Toulouse Archive Ouverte (OATAO)

OATAO is an open access repository that collects the work of some Toulouse researchers and makes it freely available over the web where possible.

This is an author's version published in: <https://oatao.univ-toulouse.fr/20798>

To cite this version :

Birro, Thiago and Aufray, Maëlen and Paroissien, Eric and Lachaud, Frédéric Prediction of Adhesion Failure of Bonded Joints using 3-Point Bending Test and Stress-Energy Coupled Criterion. (2018) In: 12th European Adhesion Conference (EURADH), 5 September 2018 - 7 September 2018 (Lisbon, Portugal).

Any correspondence concerning this service should be sent to the repository administrator:

tech-oatao@listes-diff.inp-toulouse.fr

T. V. Birro^{1,2}, M. Aufray², E. Paroissien¹, F. Lachaud¹

¹Institut Clément Ader (ICA), Université de Toulouse, CNRS, INSA, ISAE-SUPAERO, Mines Albi, UPS, 3 Rue Caroline Aigle, 31400 Toulouse, France

²CIRIMAT, Université de Toulouse, CNRS, INPT, UPS, 4, allée Émile Monso -BP 44362, 31030 Toulouse Cedex 4, France

Corresponding author: thiago.vasconcellos-birro@isae-superaero.fr

Context

In the recent years, a coupled energy and stress approach has been used successfully to treat problems involving stress concentration since the stress-based criteria only are no more valid near a singularity. For the adhesive failure characterization, Roche et al. [1] have developed a 3-point bending test which has a similar stress concentration condition, and thus the coupled criterion can be applied to predict the failure of the adhesively bonded joint.

Material

Aluminum substrate 2024 T3 – Laminated:

- ✓ $E_{subst}=68$ Gpa
- ✓ $\nu=0,33$

Polymer: DGEBA/DETA:

- ✓ $E_{poly}=3$ Gpa
- ✓ $\nu=0,33$

Surface treatment:

- ✓ Nitric acid: 400g/L
- ✓ Different temperatures
- ✓ Different time exposition

Polymerization cycle:

- ✓ 1 Hour at 150°C

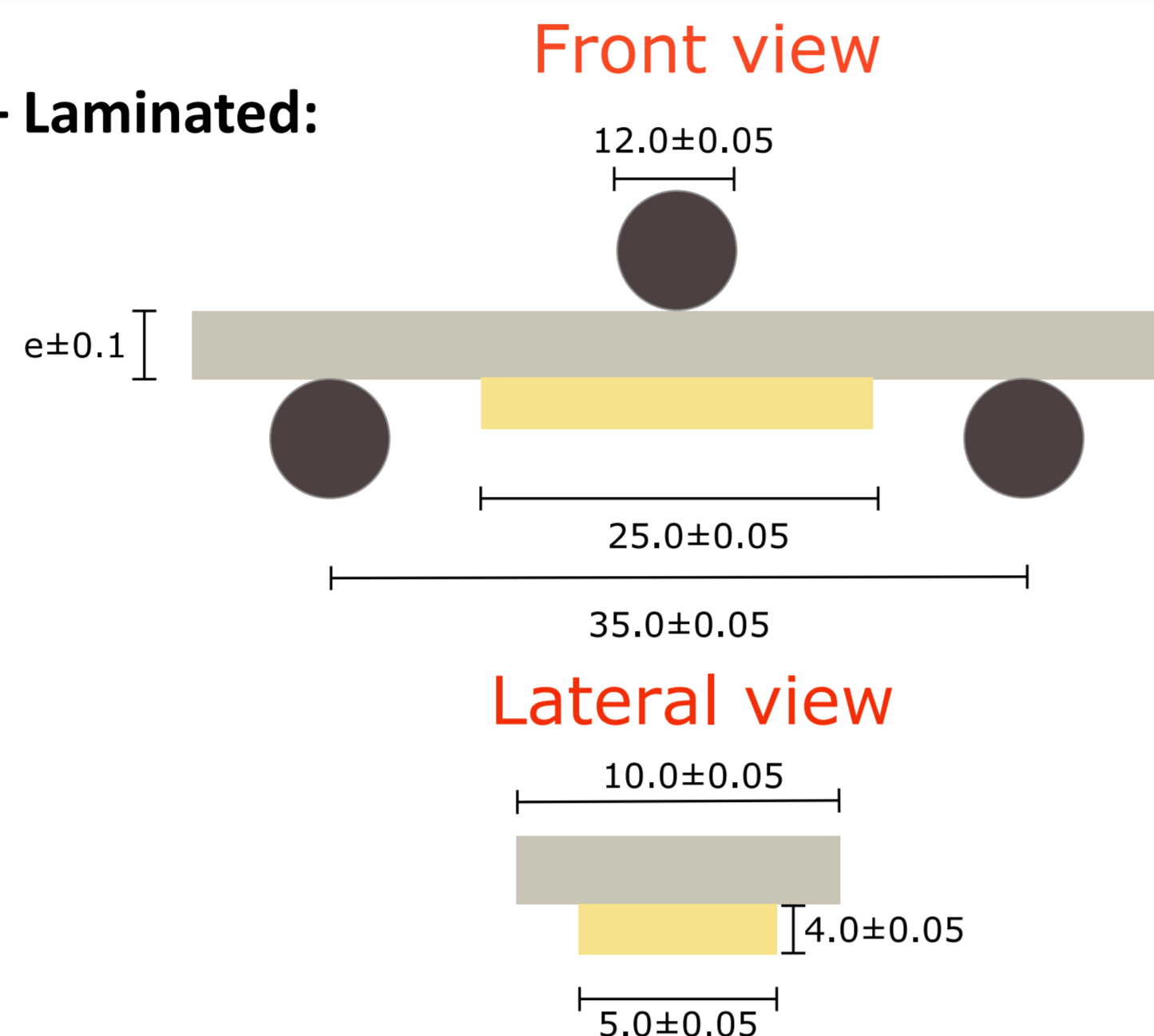

Method

3-Point bending test - ISO 14679-1997

- ✓ Main goal: **Adhesive failure initiation**

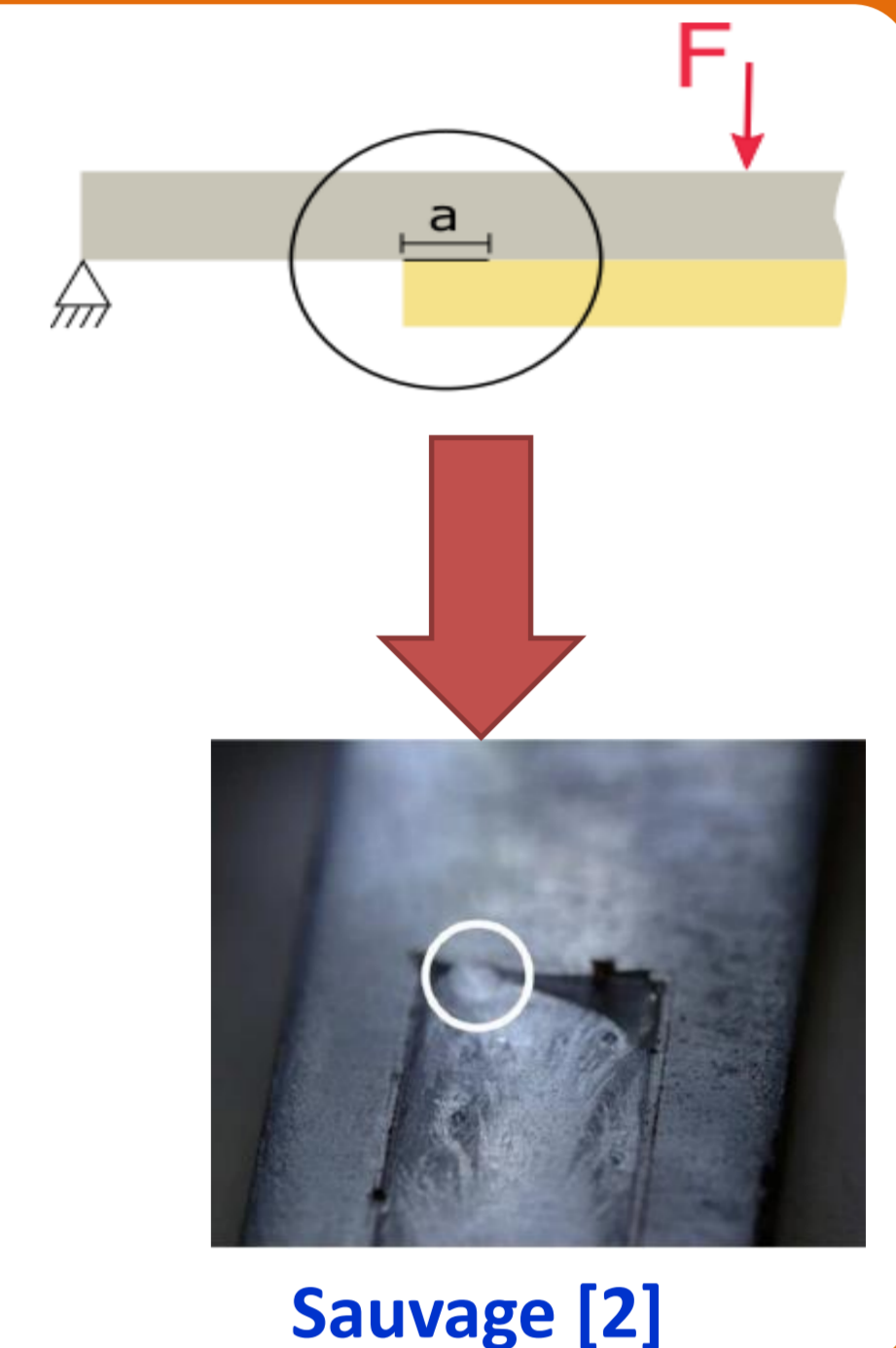
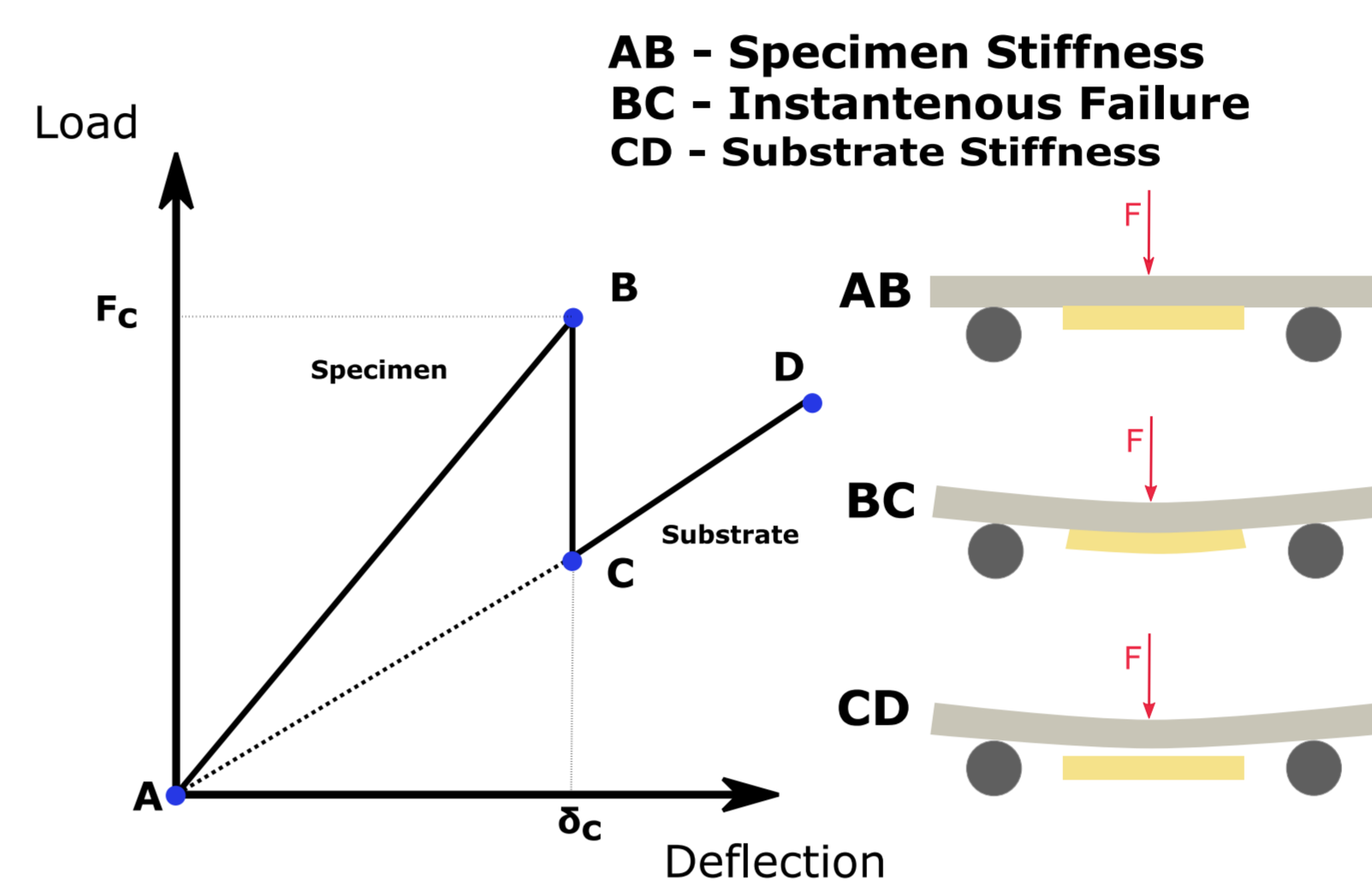

Numerical Approach

High stress concentration:

- ✓ Stress criterion is not enough to predict adhesive debonding

Coupled criterion Wei Bgraeber [3], Martin [5]:

- ✓ Strength + Energy criterion

$$G_{inc} f(\sigma_{ij})$$

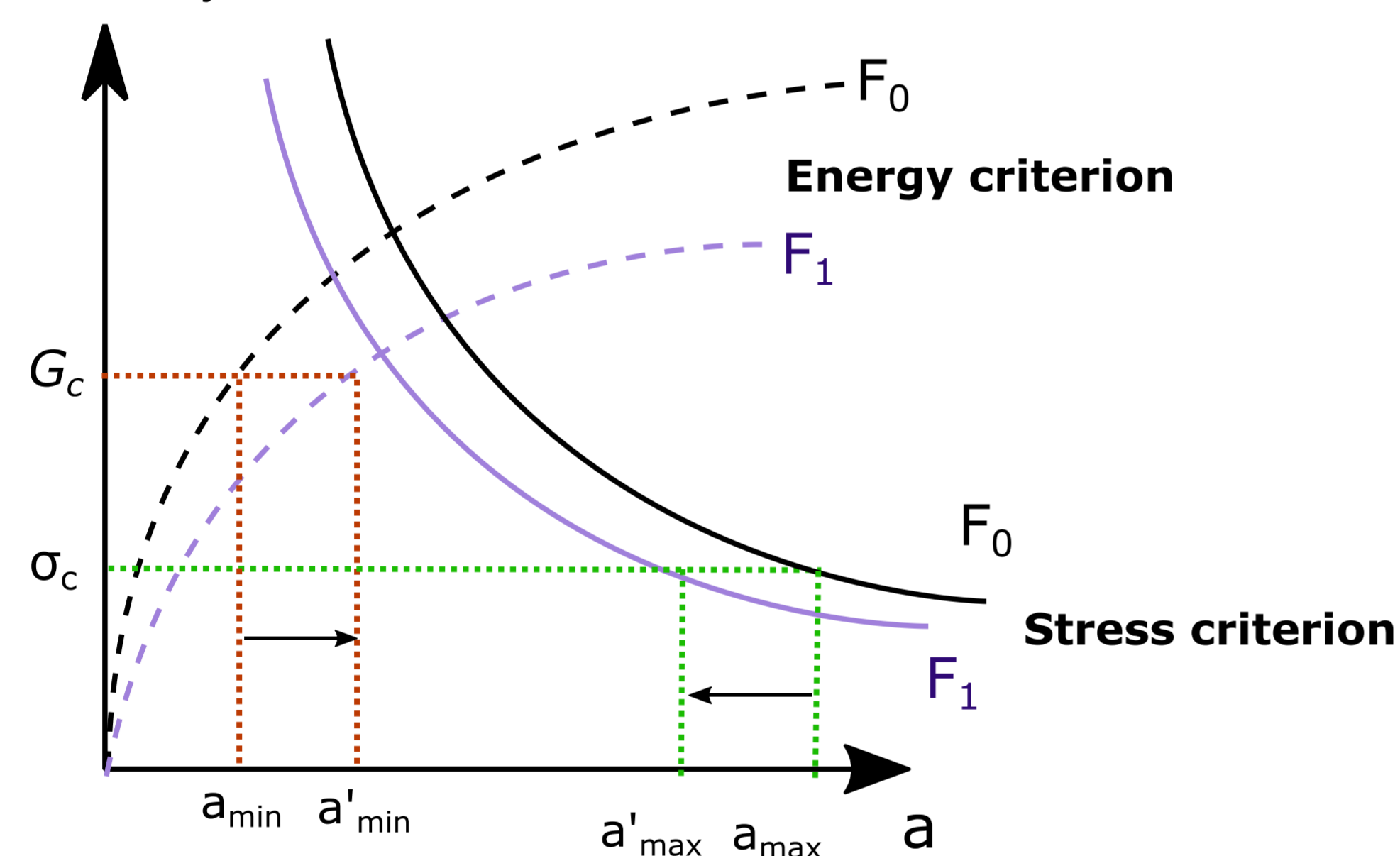

Numerical solution

Finite element method

- ✓ Use shape function
- ✓ Include singularities
- ✓ **Time consuming**

Stress and fracture toughness

Analytical solution

Limited geometries

Semi-analytical solution

Macro-element method

- ✓ No shape function: Local equilibrium of adherents
- Shape of EDO solutions
- ✓ **Fast solution**

Macro-Element representation Paroissien [4]

- Simplified approach for the stress analysis of bonded or hybrid (bolted/bonded) joints
- Bed of shear and peel springs
- Two materials simulated as Euler-Bernoulli beams
- Interface region: bed of springs – **high stiffness** for perfecting bonding

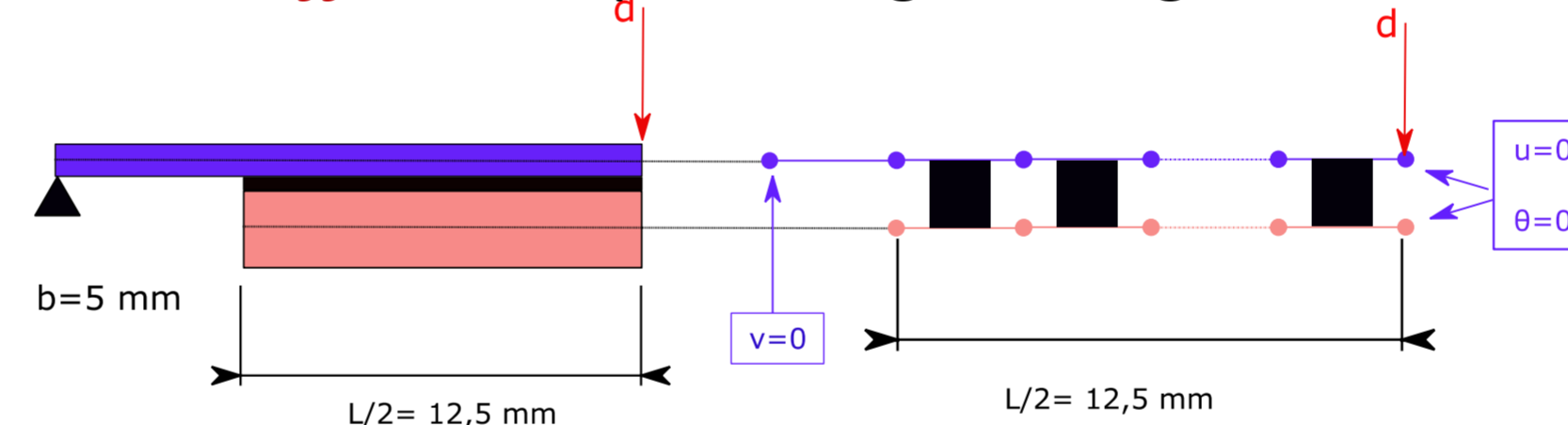

Dialogue test - simulation

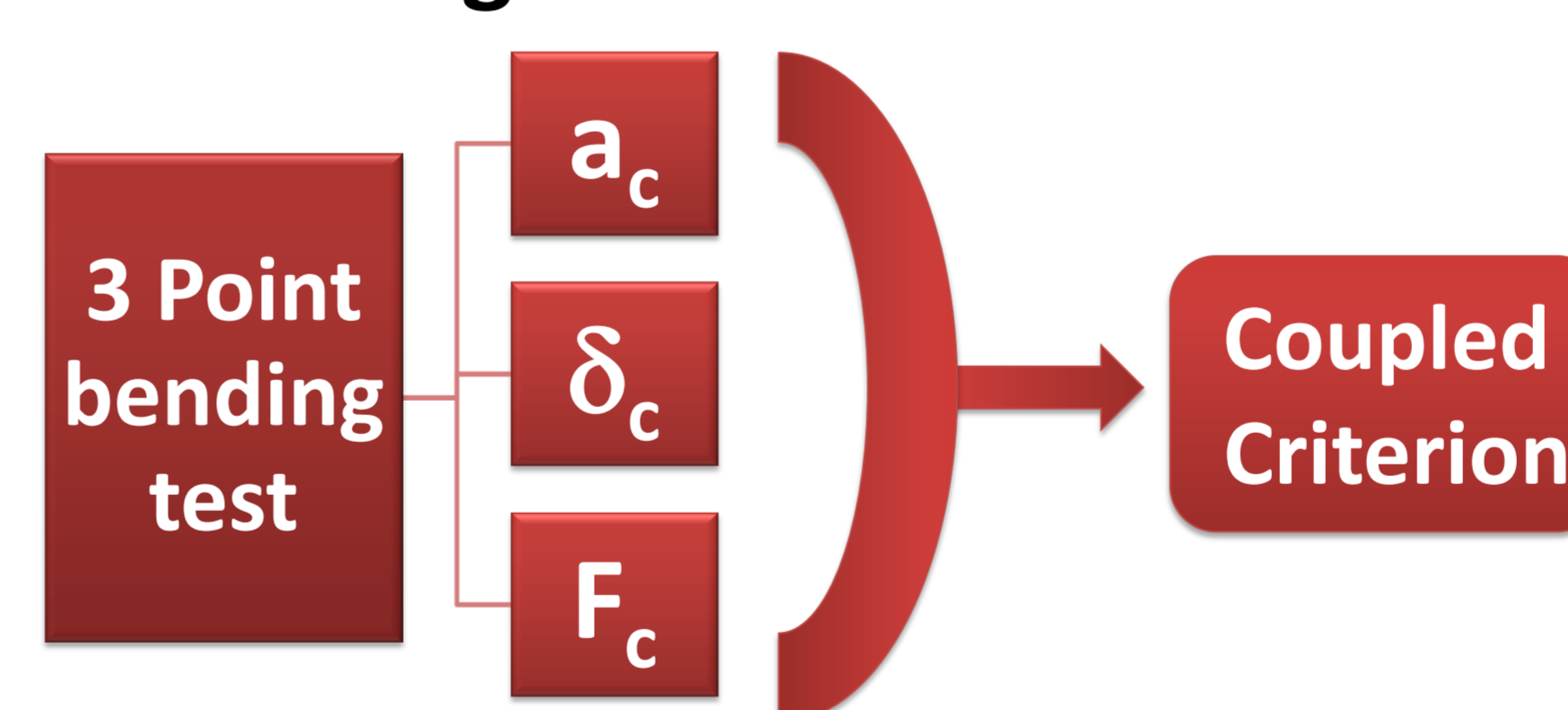

Inputs – Sauvage [2]

	F_c (N)	$a_c/2$ (mm)
$e_{subst}=1,0$ mm	86,0	0,055
$e_{subst}=1,6$ mm	126,6	0,0559

- Evaluation of peel stiffness on fracture toughness and critical stress ($K_I=K_{II}$)
- First approach: **mixed mode not included**

Fracture toughness

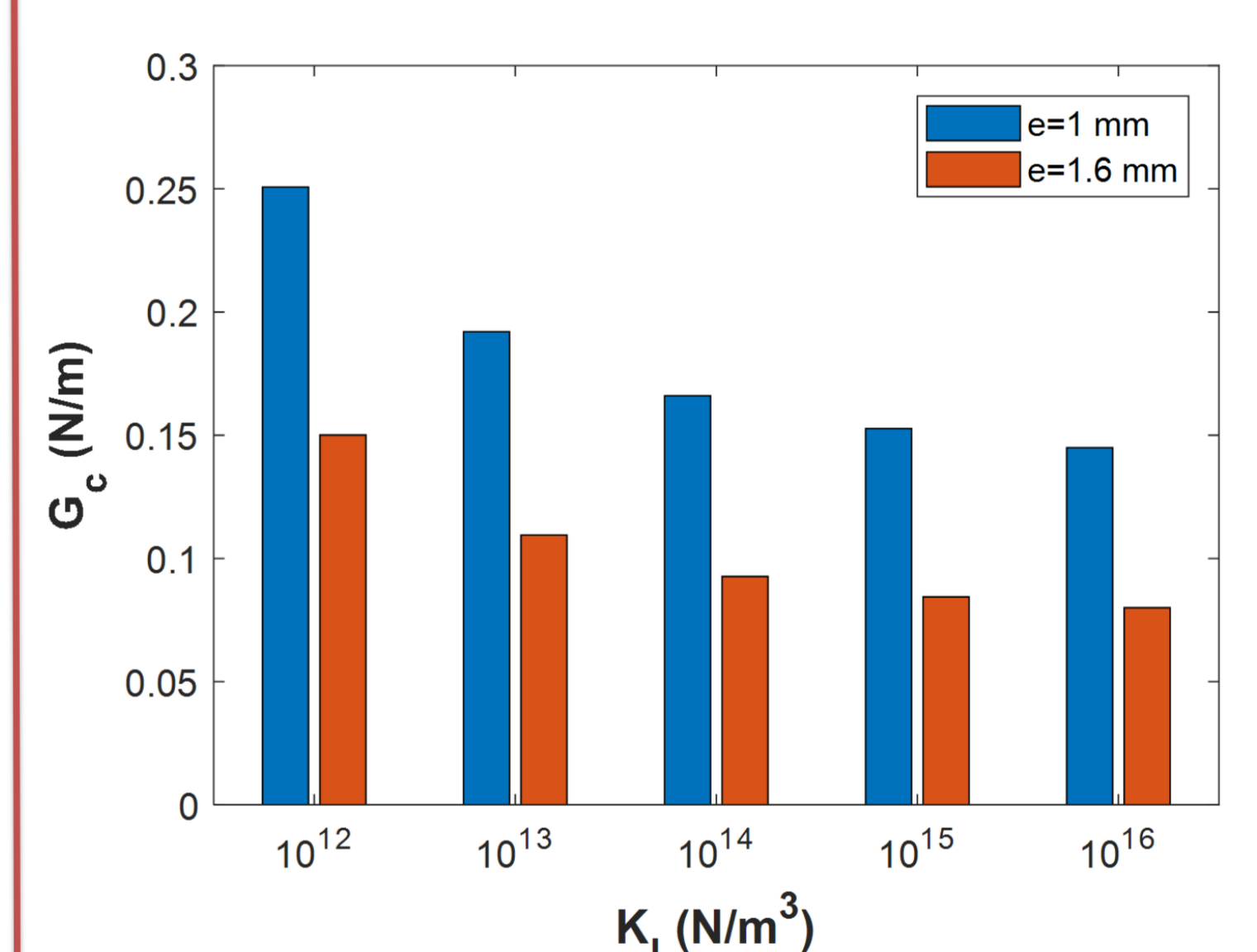

Critical stress

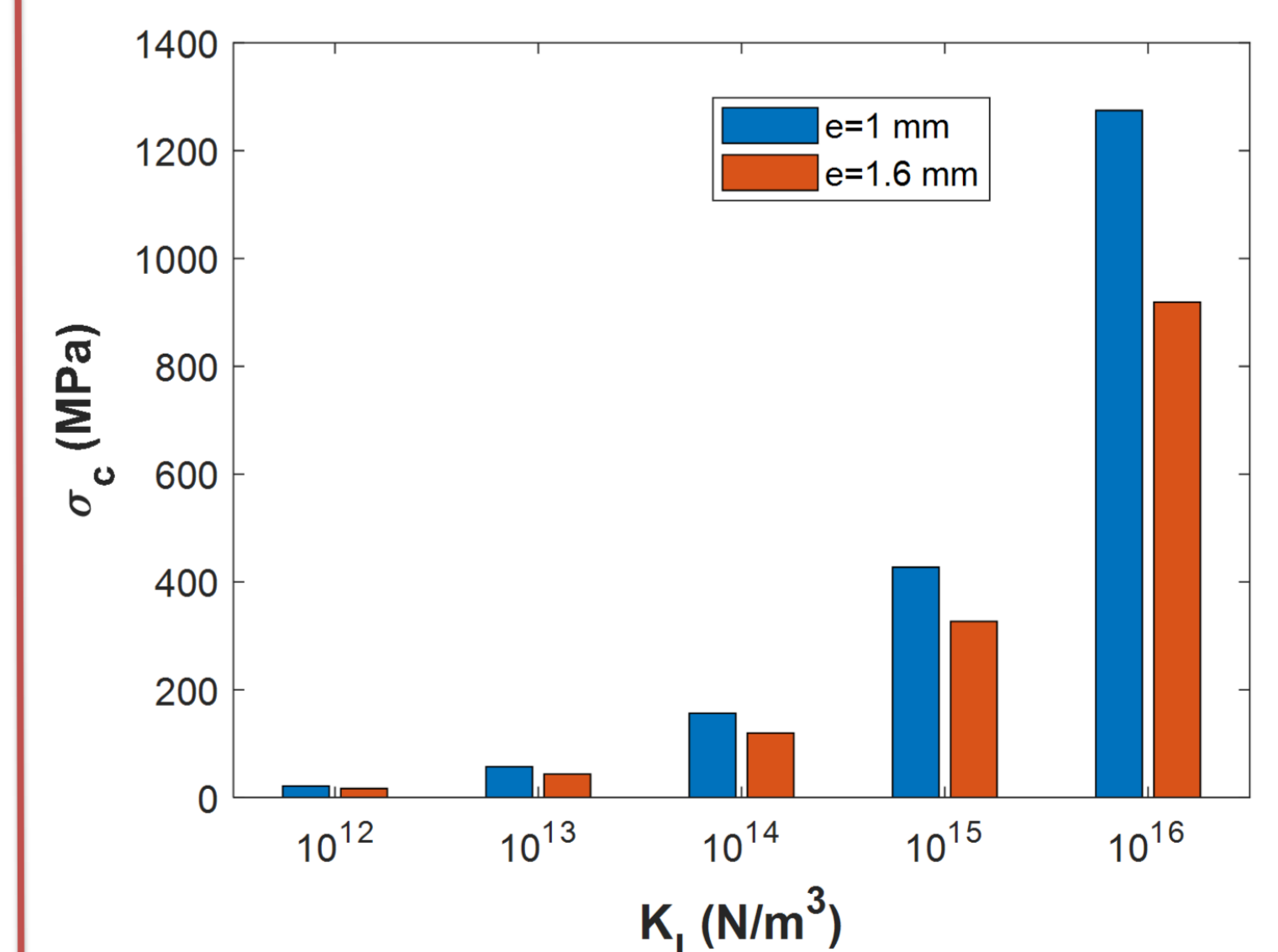

Conclusions and perspectives

Conclusions

- ✓ Dispersions: they disallowed a complete equivalence of fracture toughness
- ✓ Fracture toughness of bulk polymer ($0,1 N/mm \leq G_{Ic} \leq 0,333 N/mm$)
- ✓ Find a simpler surface treatment to provide the initiation – **HOW?**
 - Nitric acid etching – Different duration and temperatures

Perspectives

- ✓ Include the mixed mode
- ✓ Evaluation of residual stresses and the gradient of properties

References

- [1] A.A. Roche, A.K. Behme, J.S. Solomon, Int. J. Adhes. Adhes., 2, 24 (1982).
- [2] J-B. Sauvage, M. Aufray, J-P. Jeandrou, P. Chalandon, D. Poquillon, M. Nardin, Int. J. Adhes. Adhes., 75, 181 (2017).
- [3] P. B. Wei Bgraeber, W. Becker, Int. J. Solids Struct., 50, 2383 (2013).
- [4] E. Paroissien, F. Lachaud, S. Schwartz, A. Da Veiga, P. Barrière, Int. J. Adhes. Adhes., 77, 183 (2017).
- [5] E. Martin, T. Vandellos, D. Leguillon, N. Carrère., Int. J. Fract., 199, 157 (2016).