

Overview of the recent literature on MFH applicators

Olivier Sandre (WG4)



**Medical requirements for
Magnetic Hyperthermia application**



**LISBON
2015**

A broad variety range of MFH applicators

- Lab-made setups
- Commercial setups for other purposes than MFH research (dentistry, jewelry, soldering)
- Commercial setups dedicated to MFH research

- Applicators for SAR measurements
- Applicators for in vitro MFH (Petri dishes for cell culture)
- Applicators for in vivo MFH (pre-clinical assays on rodents, clinical assays on humans)

- Mono-frequency solid-state generators vs. multi-frequencies resonant circuits
- Open coils vs. ferrite circuits: control of field lines
- Hollow pipe vs. multi-strand conductor (Litz wire), water-circulation vs. air-cooling...

- Adiabatic conditions or not (need thermal loss correction)
- Thermometry: localized T-measurement (fiber probe) vs. infrared thermometry
- H field intensity and frequency assessment: redaction of a technical note by WG4

General concepts

a) Coil vs. b) Ferrite core

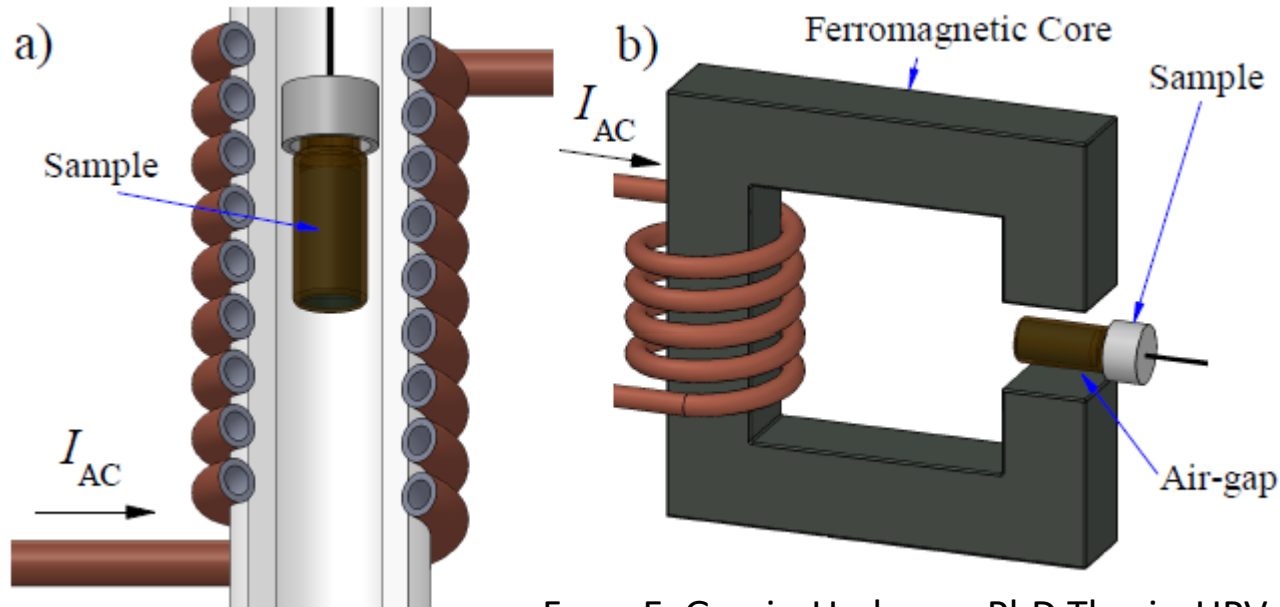

From E. Garaio-Urabayen PhD Thesis, UPV-EHU, March 2015

$$B(\text{Tesla}) \approx \frac{\mu_0 N \times I}{L}$$

- a) Air-coils sample located in the center where the H field is more homogeneous and intense
 - b) Ferrite cores to concentrate the magnetic flux B inside sample, more homogeneous field
- When large usable-gaps or usable volumes are required (whole human body applicators), electromagnetic applicator based on ferromagnetic cores are preferred). However, ferrite cores implies additional power consumption, especially at high frequencies.

In vivo applicator: clinical (human)

Clinical human applicator

Pr Andreas Jordan, Charité hosp. Berlin

MagForce AG, www.magforce.de

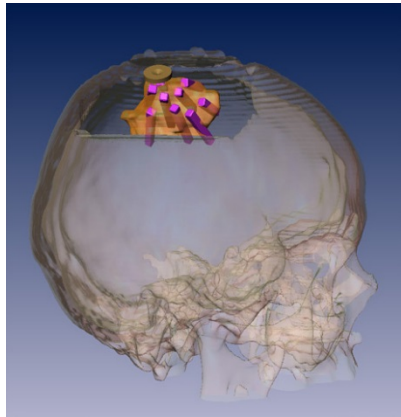

$$C_{\gamma\text{-Fe}_2\text{O}_3}^{\text{tumor}} \approx 160 \text{ g/L}$$

Computer-assisted Injection
of magnetic NPs in
glioblastoma (NanoPlan®)

2003: Beginning of phase 1 clinical trial

2007: End of phase 1 clinical trial

2011: End of phase 2 clinical trial (68 patients)

Nowadays: Authorized on market in Europe



NanoActivator™) $T_{\text{tumor}}=43\text{-}50^\circ\text{C}$

$f_{\text{RF}}=100 \text{ kHz}$, $H_0=2 - 18 \text{ kA/m}$, $B_0=2.5 - 23 \text{ mT}$

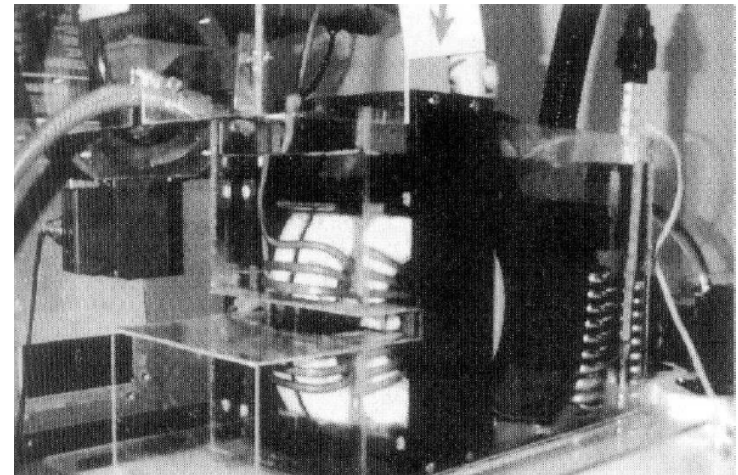

Picture of prototype (courtesy L. Vekas)

Components Of The NanoTherm® Therapy:

Novel method for local treatment of tumors

THERAPY PLAN

1. INJECTION

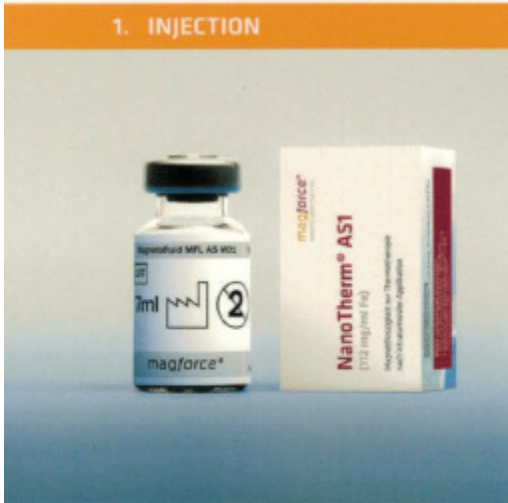

Iron oxide nanoparticles are injected directly into the tumor using conventional methods following therapy planning

NanoTherm® is a colloidal dispersion of superparamagnetic iron oxide nanoparticles with a diameter of approx. 15 nm and a coating of aminosilane. The iron concentration of the dispersion is 112 mg/ml (or 335 mg/ml)

NanoTherm® is injected directly into the tumor in an intraoperative procedure

Due to their special coating, the nanoparticles remain at the injection site

2. TUMOR TEMPERATURE SIMULATION



Treatment temperatures and corresponding magnetic field strengths are defined by the physician before the start of therapy (Post Implantation Analysis, PIA)

The software NanoPlan® simulates temperature distribution in the treatment area and suggests magnetic field strength for NanoTherm® therapy

The basis of the treatment plan is the concentration and position of the nanoparticles in the tumor measured by postoperative CT and temperature maxima defined by the physician

Components Of The NanoTherm[®] Therapy: Novel method for local treatment of tumors



The magnetic field applicator NanoActivator™ activates the nanoparticles from the outside

The iron oxide nanoparticles convert the magnet field energy into heat

Treatment temperatures of up to 80° C can be achieved

Temperature > 40° C enhances the effects of radio-/chemotherapy and stimulates certain pathways of the immune response

When temperatures above 43° C are applied over 60 minutes, non-reversible cell damage occurs

Components Of The NanoTherm[®] Therapy:

AN ALTERNATING MAGNETIC FIELD, WHICH CHANGES ITS POLARITY 100,000 TIMES PER SECOND, ACTIVATES THE NANOPARTICLES



- Magnetic field activates Neel and Brownian relaxation processes of iron oxide nanoparticles generating heat
- Magnetic field strengths of approx. 2-15 kA/m
- NanoActivator™ induces therapeutic treatment temperatures within the tumor of > 40 °. Thermotherapy effect enhances the efficacy of radio- and chemotherapy
- Innovation values of NanoActivator™
- Can be applied to solid tumors in all body regions
- First therapy device specifically for nanomedicine
- Dose adjustment during therapy by regulating the magnetic field strength
- Direct intratumoral temperature measurement during therapy for securing optimal therapeutic temperatures and patient safety

“Medical requirements for Magnetic Hyperthermia application” – Lisbon, April 16th 2015

In vivo applicators: pre-clinical (rodents)

Example of lab-made *in vivo* setup

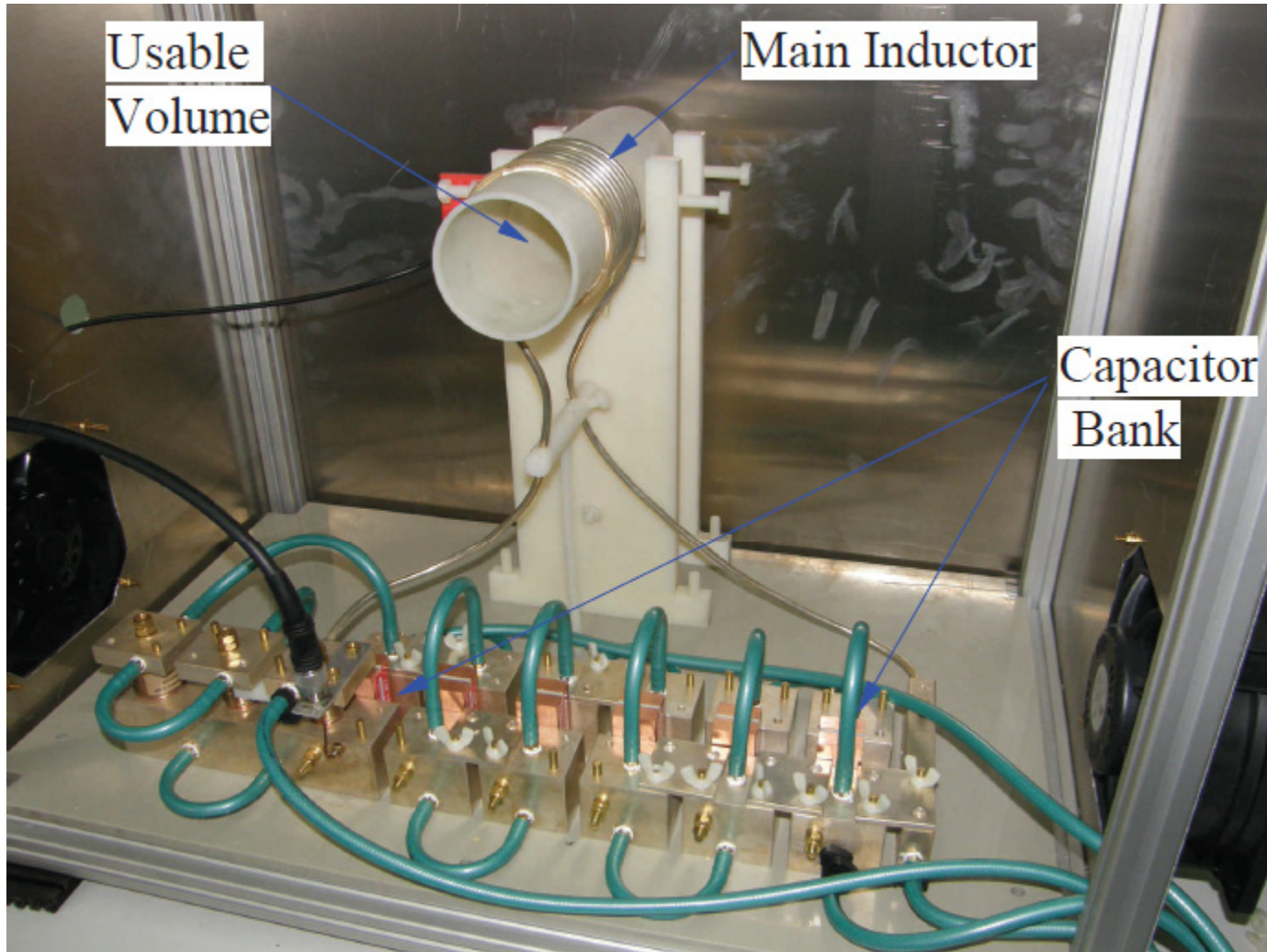

Nanotherics magneTherm™

Heat-Generating Iron Oxide Nanocubes: Subtle “Destructurators” of the Tumoral Microenvironment

Direct injection of nanocubes
in the tumor (0.7 mg iron)

Exposure to the alternating
magnetic field (3x 30 min)

110 kHz – 23,8 kA/m

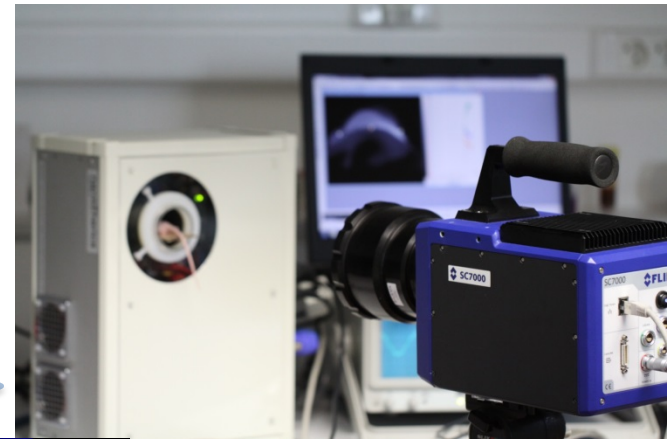
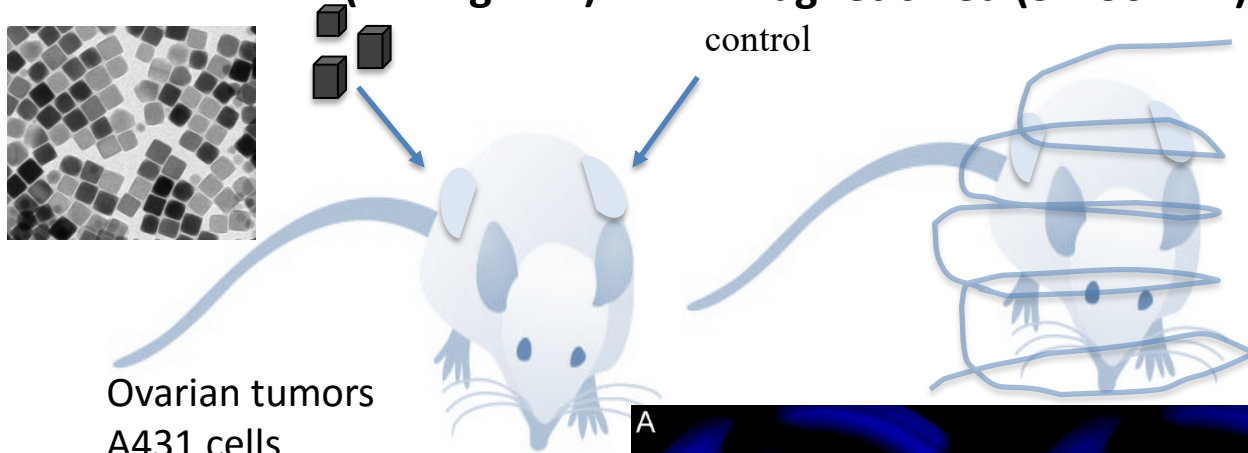

Ovarian tumors
A431 cells

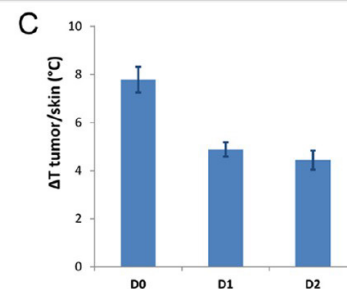
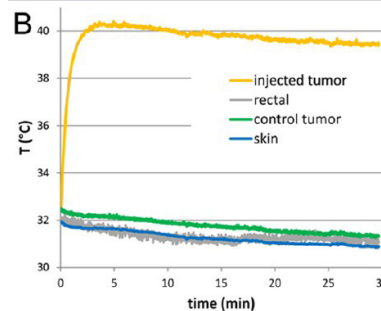
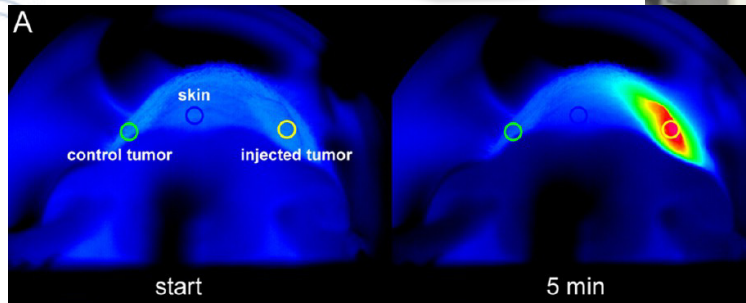
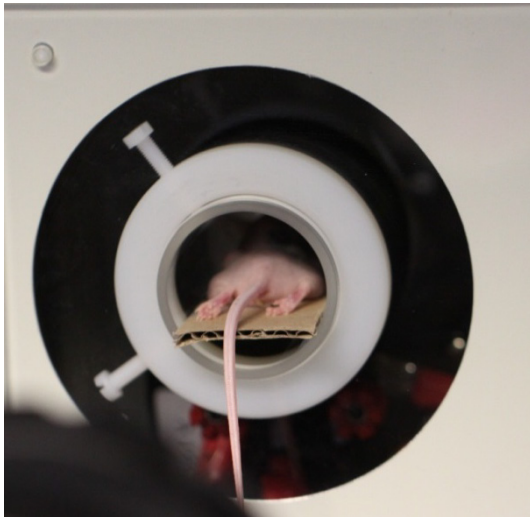

J. Kolosnjaj-Tabi et al
ACS Nano 8, 4268, 2014

“Medical requirements for Magnetic Hyperthermia application” – Lisbon, April 16th 2015

Nanotherics magneTherm™

Recommended accessory for *in vivo* experiments:
Mouse restrainer / water-jacket (37°C)



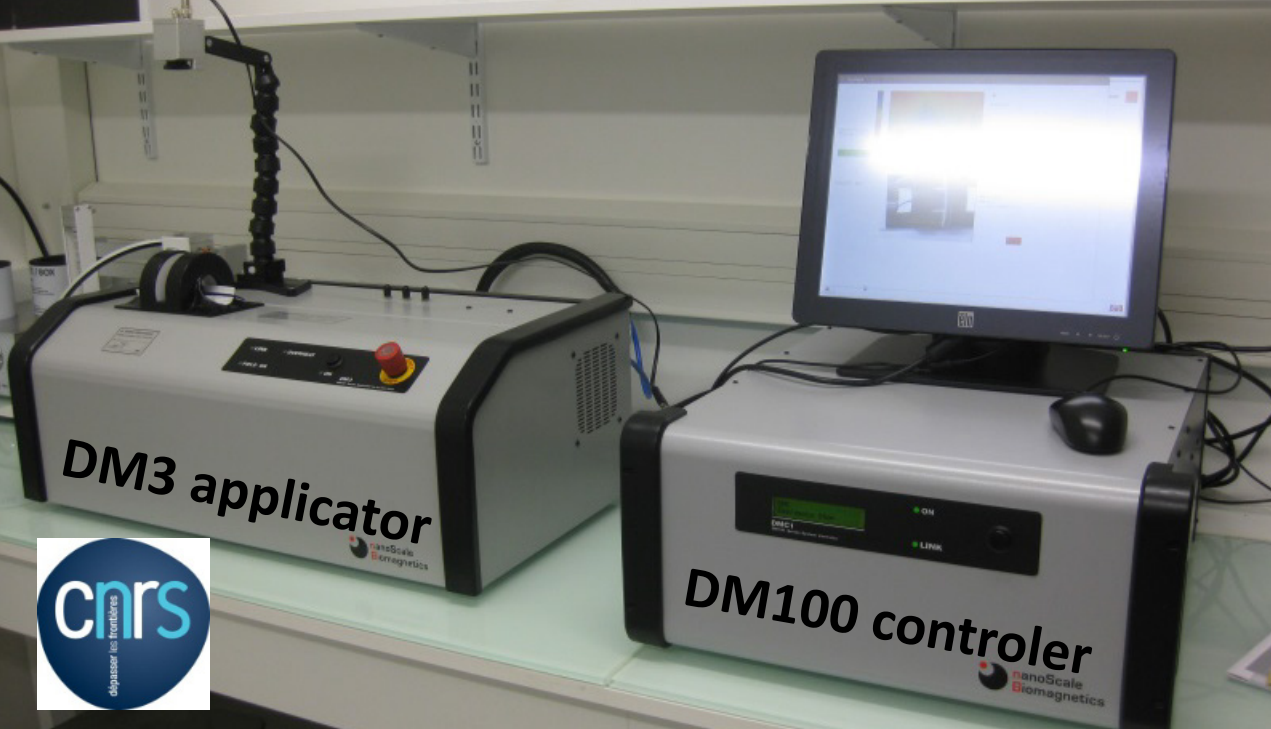

Mission interdisciplinarité
Centre national de la recherche scientifique

NanoScale
Biomagnetics
nbnanoscale.com

Quadri-fréquences:
 $f = 146, 217, 344.5, 473.5 \text{ kHz}$
 $B_0^{\text{max}} = 27.6, 26, 20.4, 16.8 \text{ mT}$
 $H_0^{\text{max}} = 22, 20.7, 16.2, 13.4 \text{ kAm}^{-1}$

Inductor made of 2 coil spaced by observation window (2cm width) with open access for in vivo (anesthesia mask...)



Calle Panamá 2, Local 1
50012 Zaragoza
Spain

t. +34 976 741 714
contact@nbnanoscale.com

nbnanoscale.com

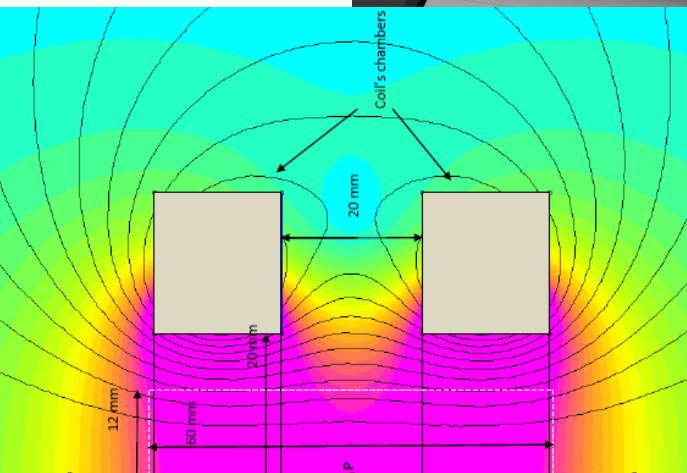
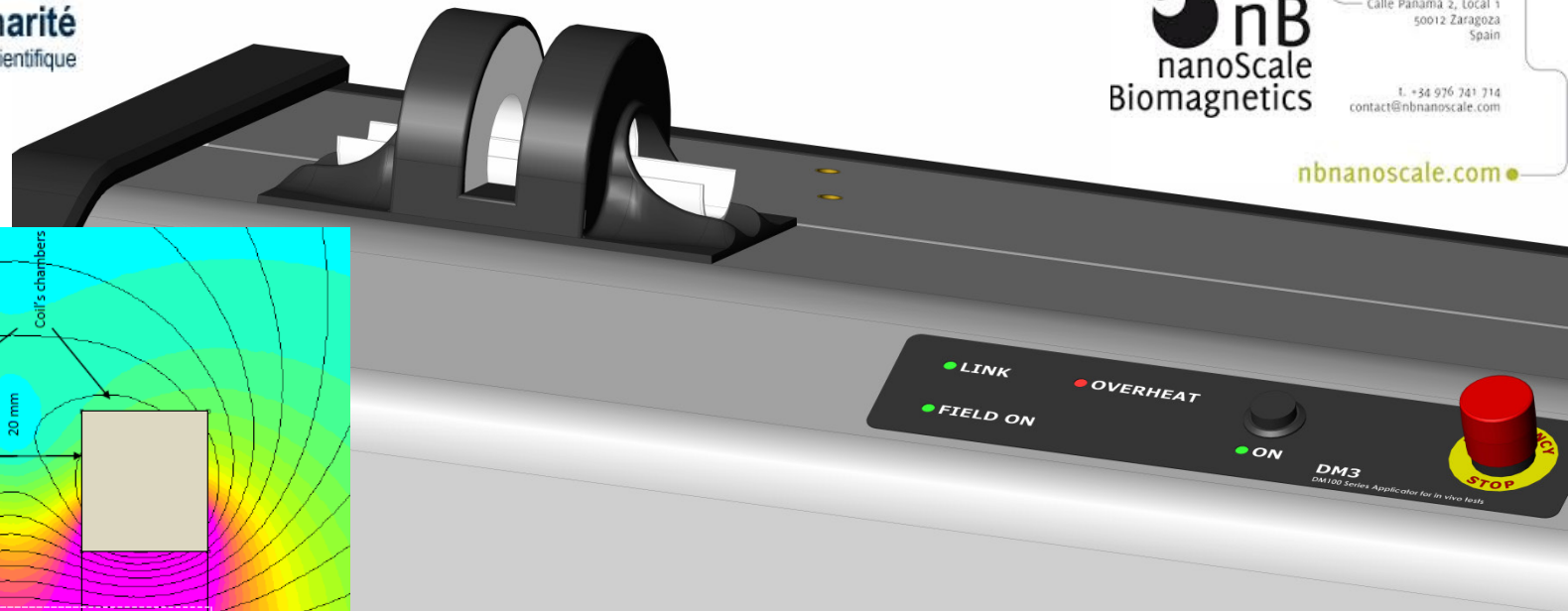

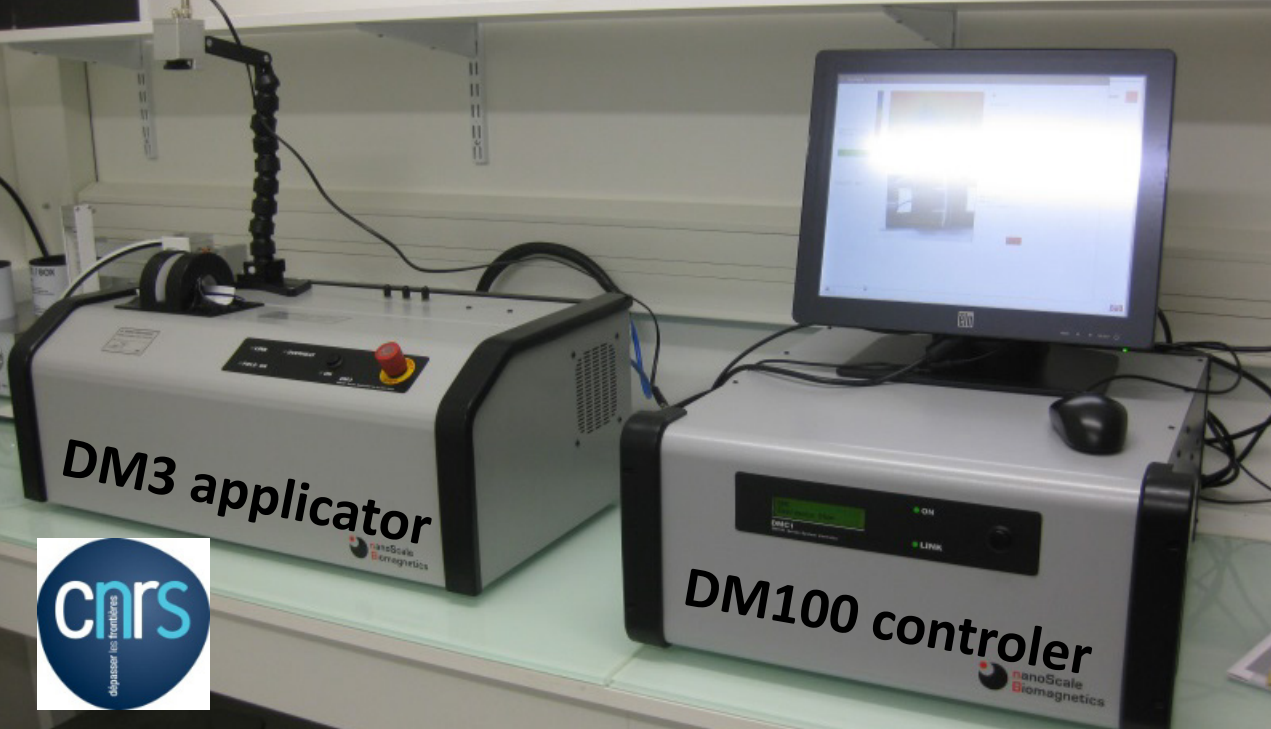

NanoScale
Biomagnetics
nbnanoscale.com

Quadri-fréquences:

$$f = 146, 217, 344.5, 473.5 \text{ kHz}$$

$$B_0^{\text{max}} = 27.6, 26, 20.4, 16.8 \text{ mT}$$

$$H_0^{\text{max}} = 22, 20.7, 16.2, 13.4 \text{ kAm}^{-1}$$

Feedback loop (with fiber optic or IR camera) control by either:

- Maximal temperature
- Thermal dose (e.g. CEM43)

Near-IR Fluorescence camera Flubeam™ 800 nm



Thermal IR camera

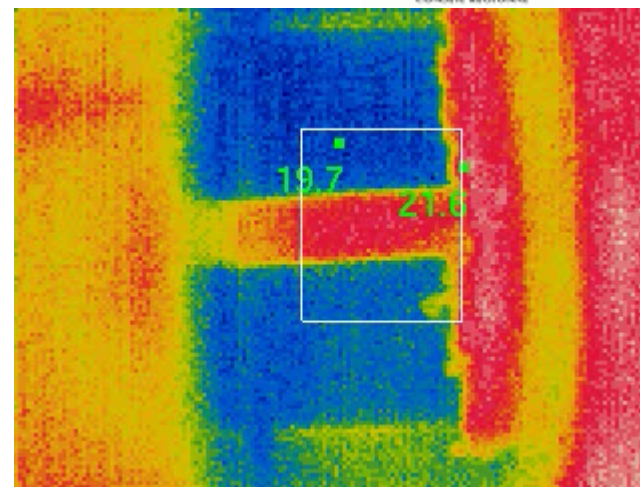

FLI
France Life Imaging

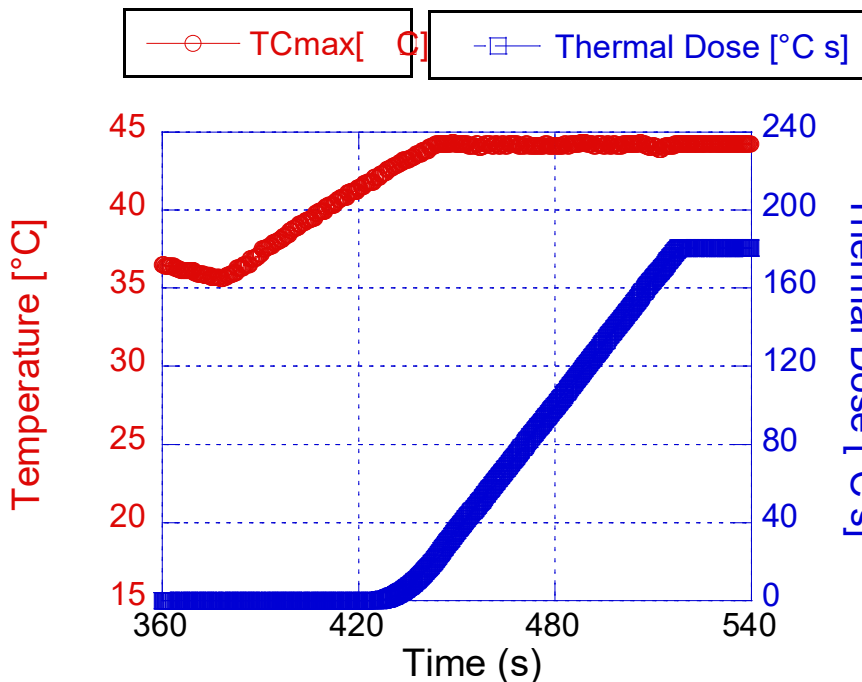

(speed x10)
"hyperthermia application" – Lisbon, April 16th 2015

Applicators for SAR measurement

Example of lab-made SAR measurement setup (Paris 97')

Current generator : 300 kHz at $f= 1.1 \text{ MHz}$ / $I_{\text{max}}= 12 \text{ A}$

J. Servais, MSC – Univ. Paris 7
J-P. Fortin et al
JACS 129, 9, 2628-2635, 2007

Fiber optic
thermometer

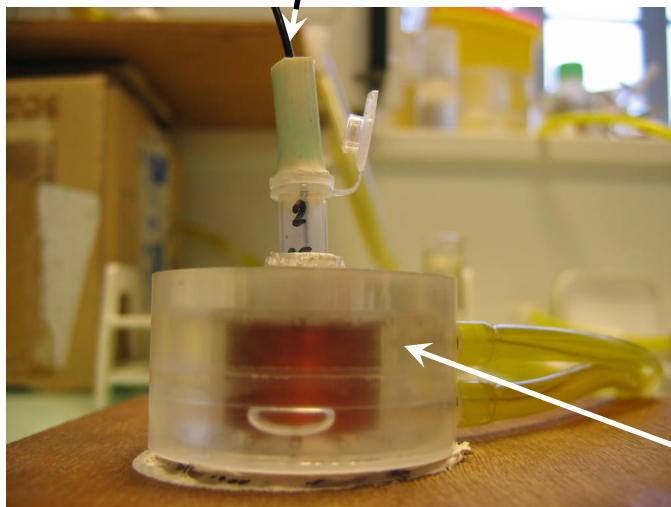
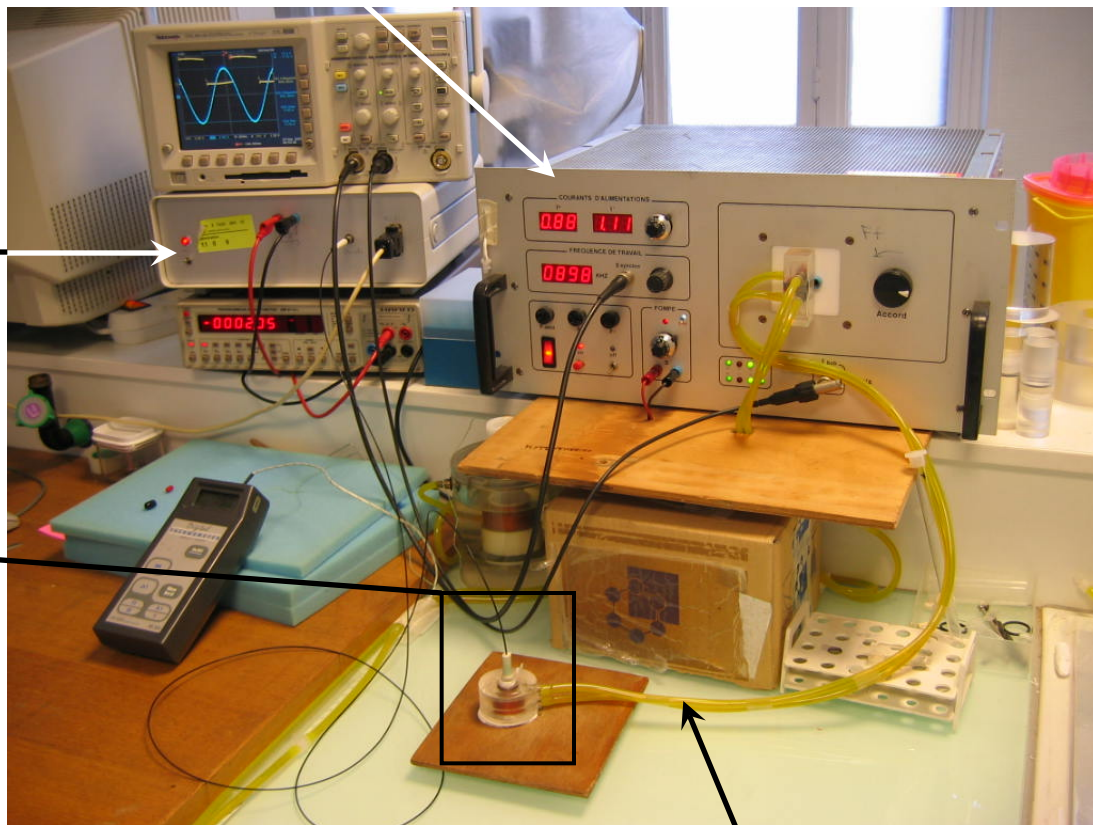

Thermal regulation (circulation of C_9H_{20} instead of water)

Coil: $\text{Ø} 12 \text{ mm}$ / $H=1.8$ ($\text{kA}\cdot\text{m}^{-1}$)/A ($H_{\text{max}}=21.6 \text{ kA}\cdot\text{m}^{-1}$)

Commercial setups for dentistry, jewelry, soldering...

- Fives Celes (Strasbourg, France) →



← Seit Elettronica Srl, Valdobbiadene (TV), Italy

- Superior Induction Company (USA)



- Ambrell (USA)



Nanotherics magneTherm™



- Is designed specifically for magnetic nanoparticle/fluid hyperthermia applications
- Offers a wide range of discrete heating frequencies
- Is a convenient bench-top size and portable
- Only requires a tap or recirculating water bath for cooling
- Can be used for *in vivo* mouse studies

nanotherics
limited

9 turn, water cooled copper coil

Nominal frequency of **174.8, 262.0, 523.4, 739.8, 987.7 kHz** up to **25 mT**

17 turn coil, water cooled copper coil

Nominal frequency of **110.8, 166.0, 332.0, 469.6 and 626.5 KHz** up to **25 mT**

“Medical requirements for Magnetic Hyperthermia application” – Lisbon, April 16th 2015

Bordeaux's setup improved with help of UPV-EHU

"VASCO Flex" by Cordouan Technologies
(startup company nearby Bordeaux campus)

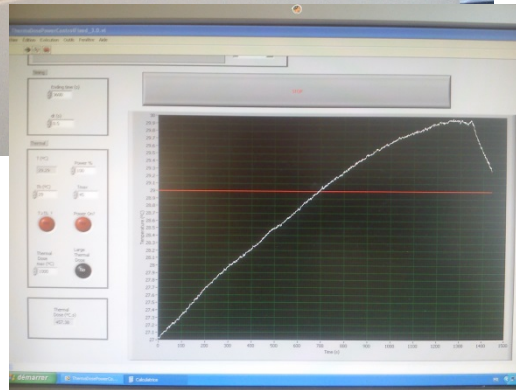
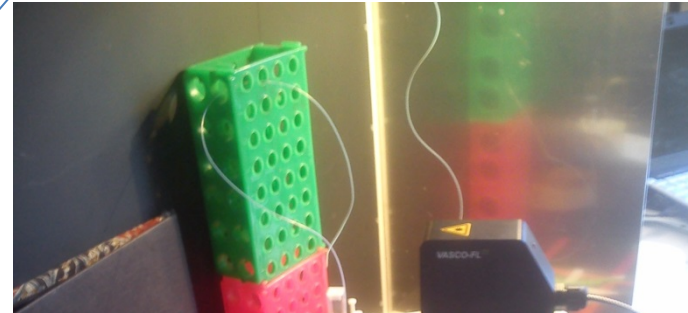

ThermalDosePowerControl3.0

Thermal Dose & Power
Control by Eneko Garaio

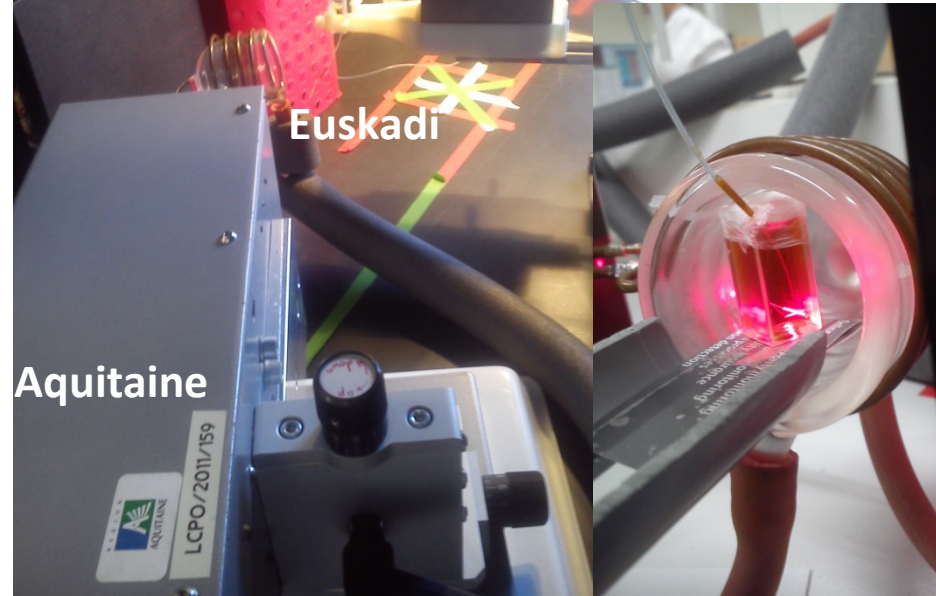

Example of lab-made SAR setup: UPV-EHU (Bilbao)

Eneko Garaio's prototype brought to Bordeaux in Spring 2014

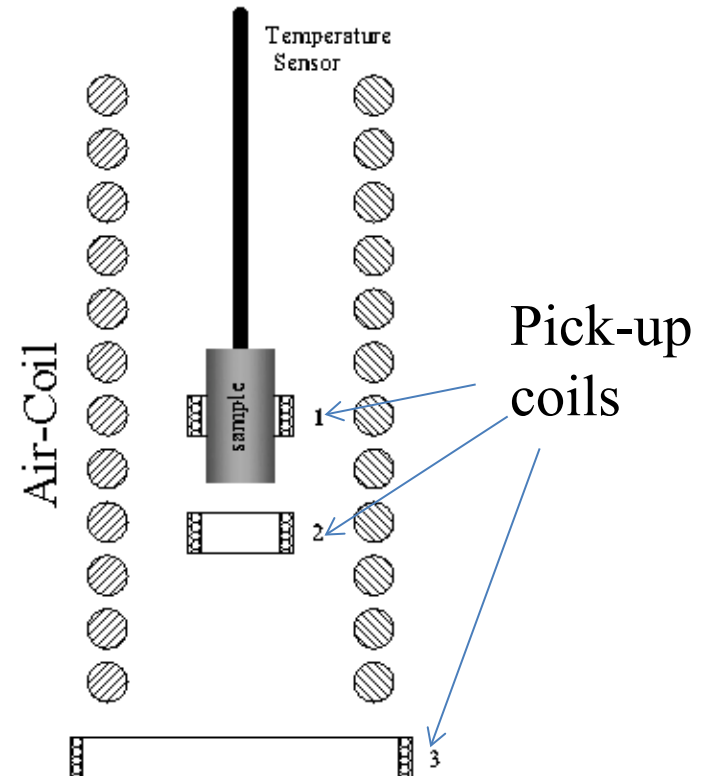
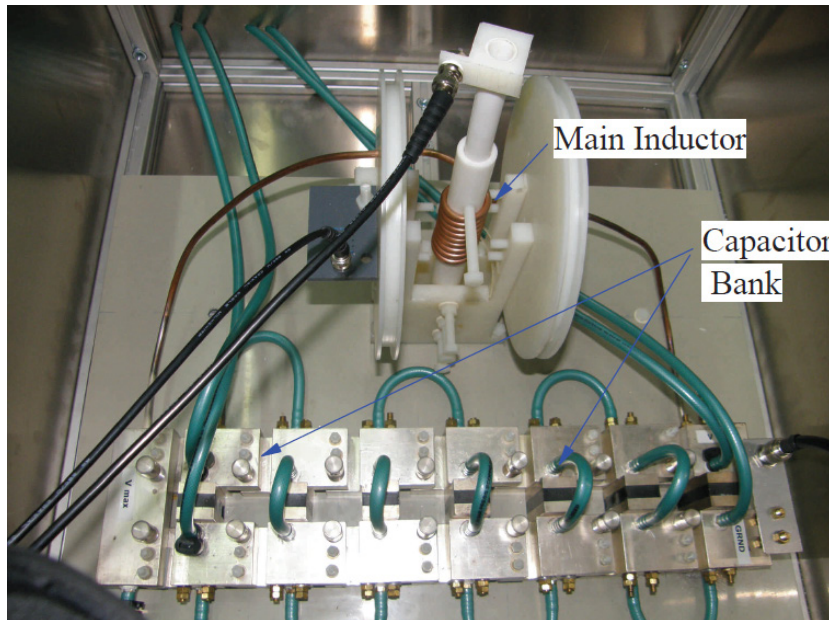

"Medical requirements for Magnetic Hyperthermia application" – Lisbon, April 16th 2015

Example of lab-made setup: all Bilbao's setups

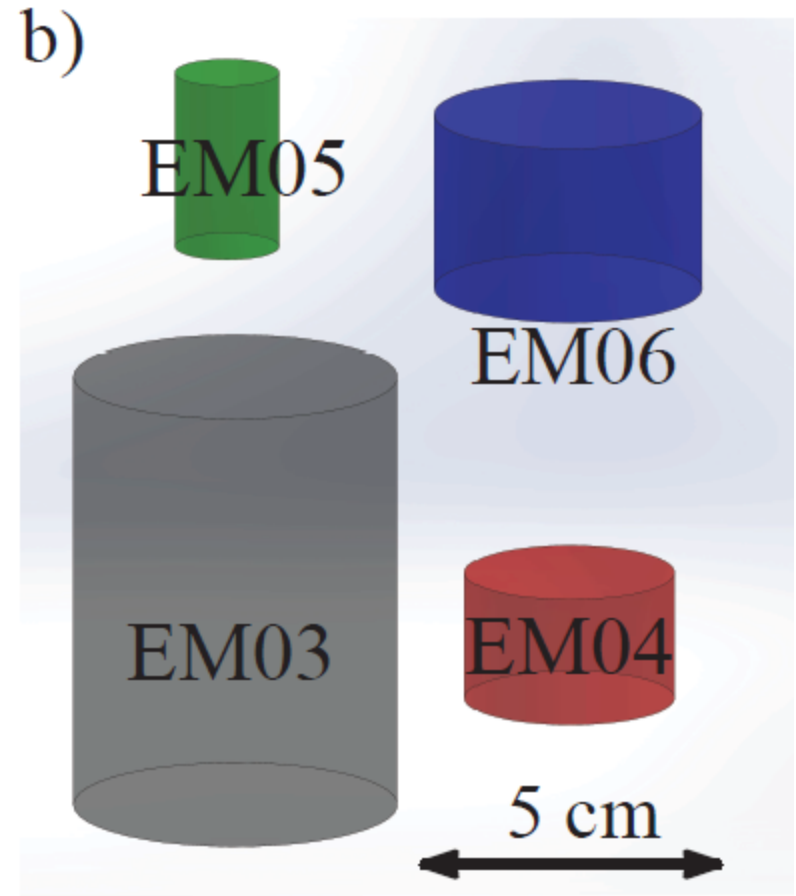
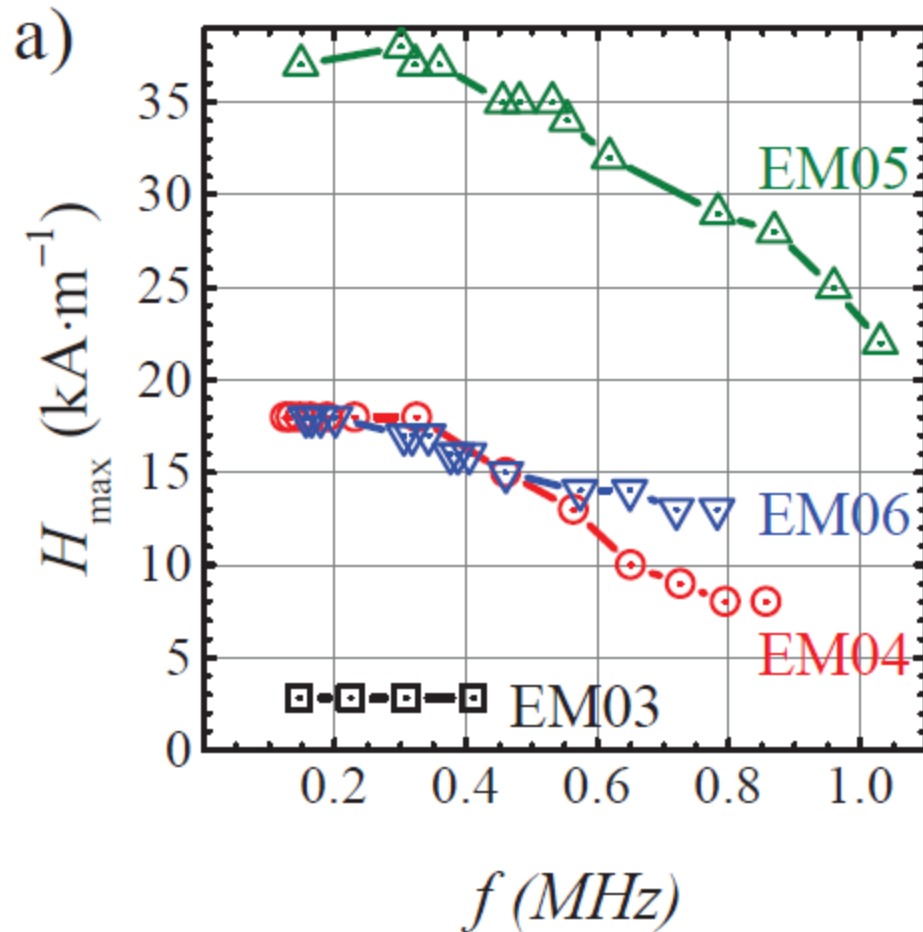

Example of lab-made SAR setup: INSA Toulouse

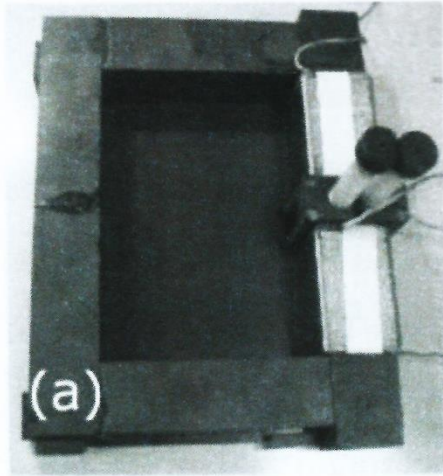

(a)

G Bf

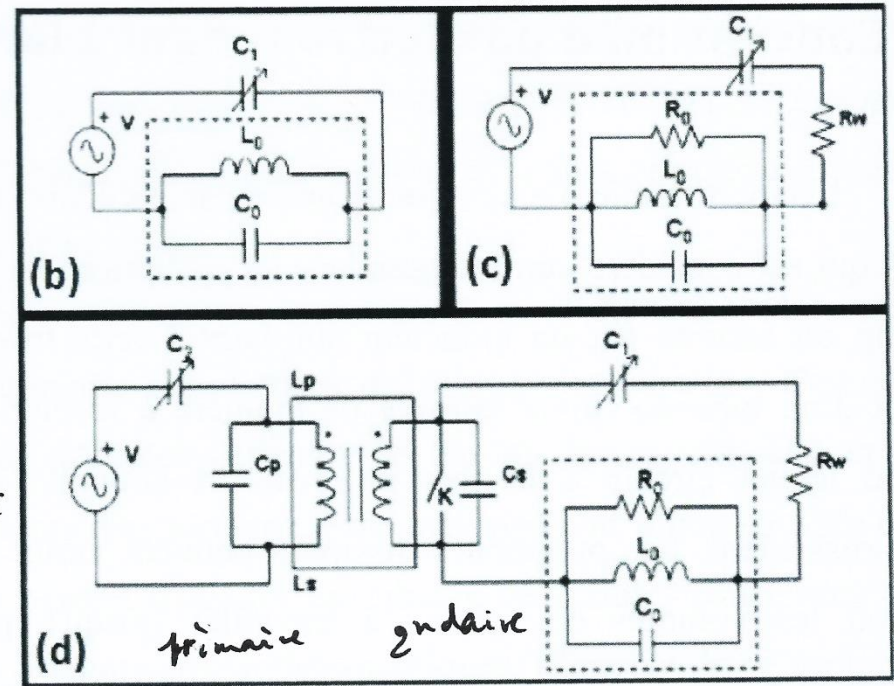

A frequency-adjustable electromagnet for hyperthermia measurements on magnetic nanoparticles
 L.-M. Lacroix, J. Carrey, and M. Respaud, REVIEW OF SCIENTIFIC INSTRUMENTS **79**, 093909 2008

Field with a gap=1.1 cm, from 19.3 mT at 100 kHz, to 4.8 mT at 500 kHz

Example of lab-made SAR setup: INSA Toulouse

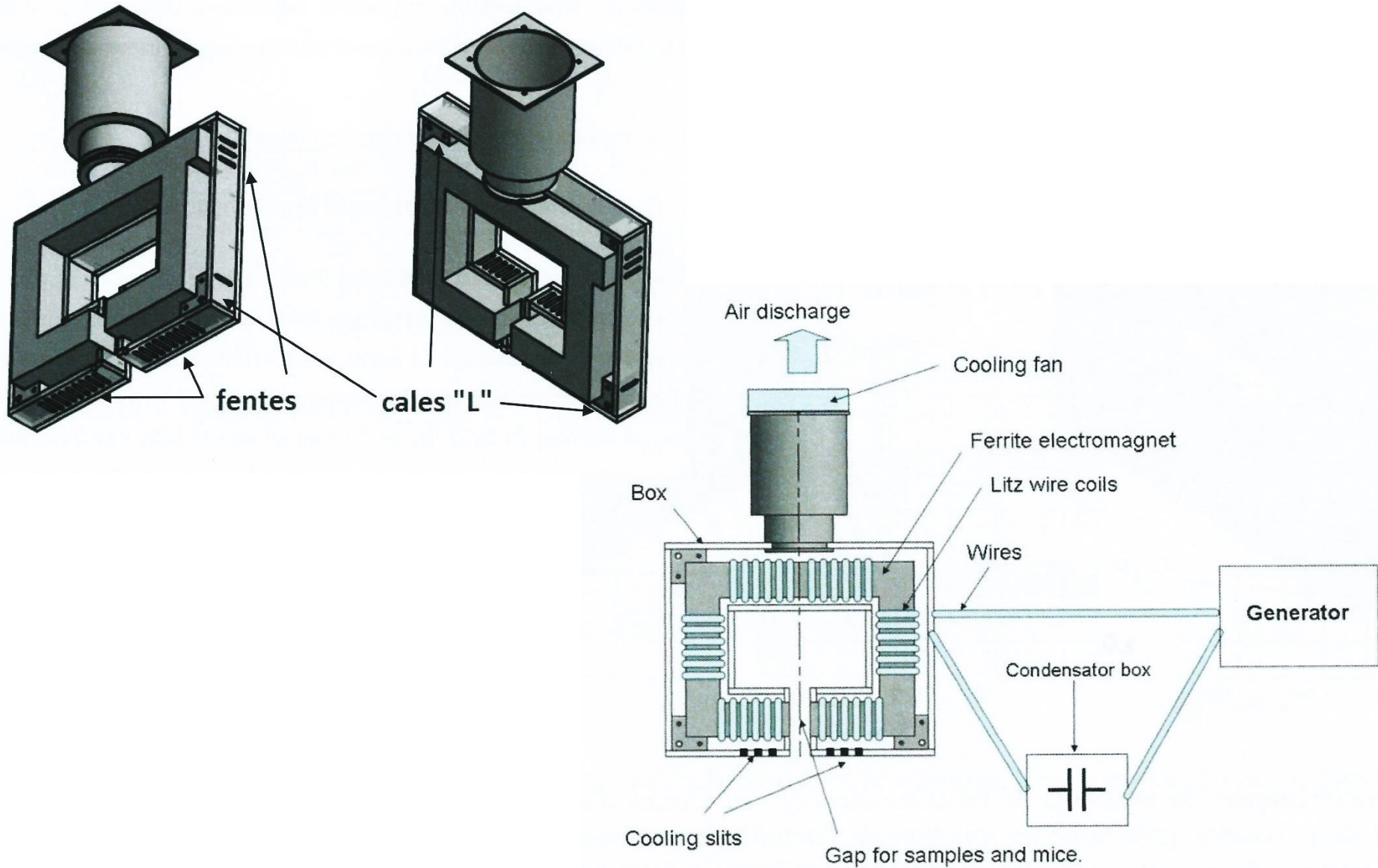

Example of lab-made SAR setup: INSA Toulouse

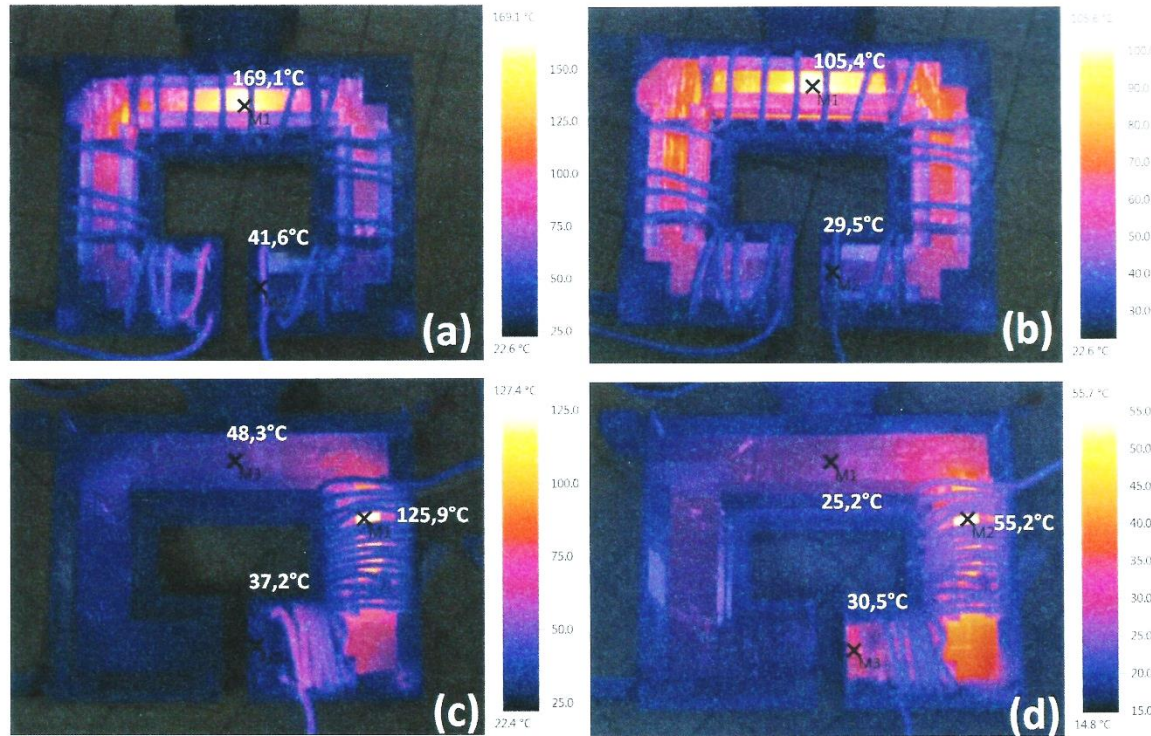

Cliché	f (kHz)	$P_{\text{gén}} \text{ (kW)}$	$I_{\text{ind}} \text{ (A)}$	$B_{\text{max}} \text{ (mT)}$
(a)	102,7	0,81	30	23
(c)	102,56	0,73	30	23

In vitro applicators
(*in cellulo*)

Example of lab-made *in cellulo* setup: INSA Toulouse

C. Sanchez et al, ACS Nano 8, 1350, 2014

Julian Carrey (INSA Toulouse) + Véronique Gigoux (INSERM CHU Rangueil)

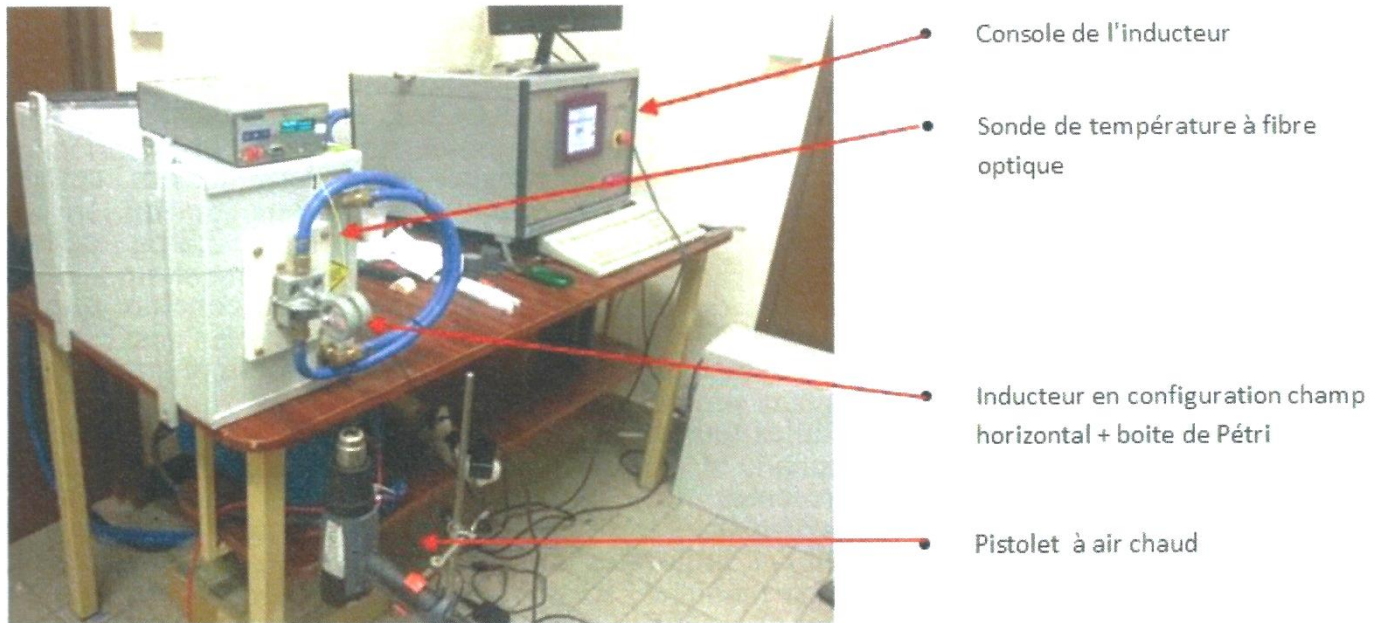
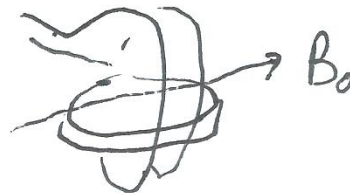

Figure III. 3 Installation expérimentale permettant l'application d'un champ magnétique alternatif *in vitro*.



III.4

Example of lab-made *in cellulo* setup: INSA Toulouse

V. Connord et al, Nanoscale 2015 (early view) doi: 10.1002/sml.201402669
Julian Carrey (INSA Toulouse) + Véronique Gigoux (INSERM CHU Rangueil)

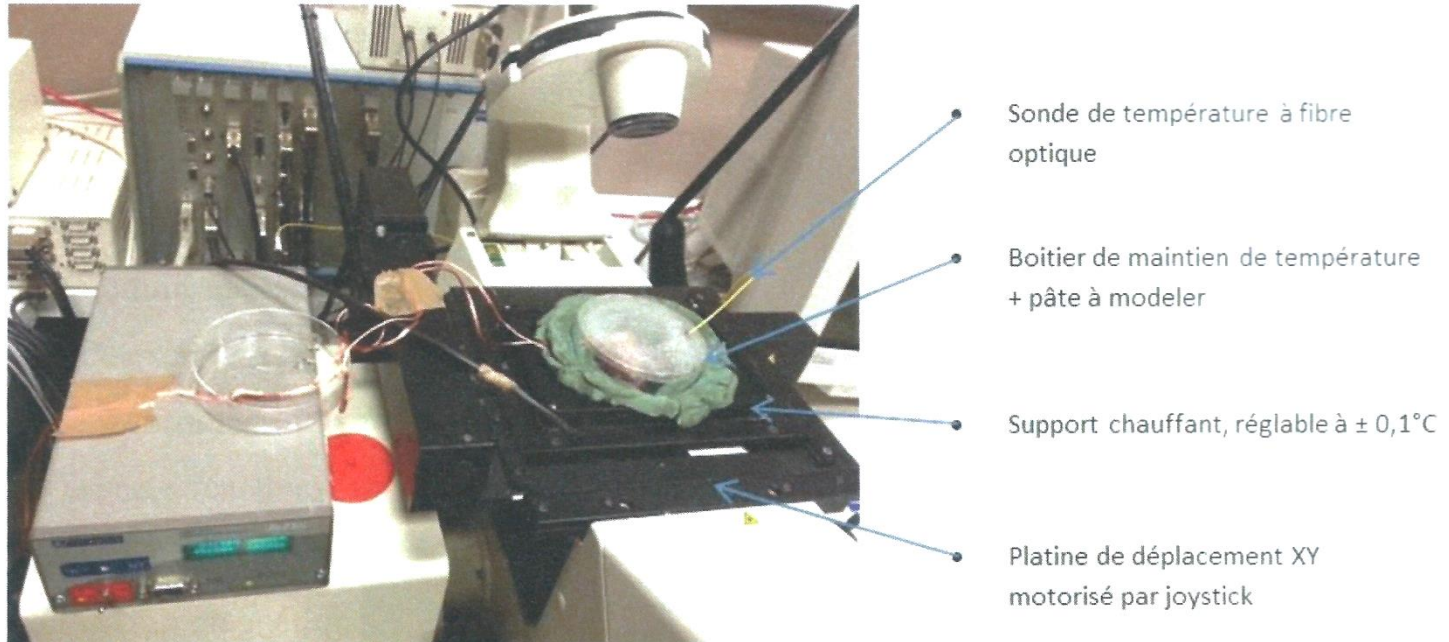

Example of lab-made *in cellulo* setup: INSA Toulouse

V. Connord et al, Nanoscale 2015 (early view) doi: 10.1002/smll.201402669
Julian Carrey (INSA Toulouse) + Véronique Gigoux (INSERM CHU Rangueil)

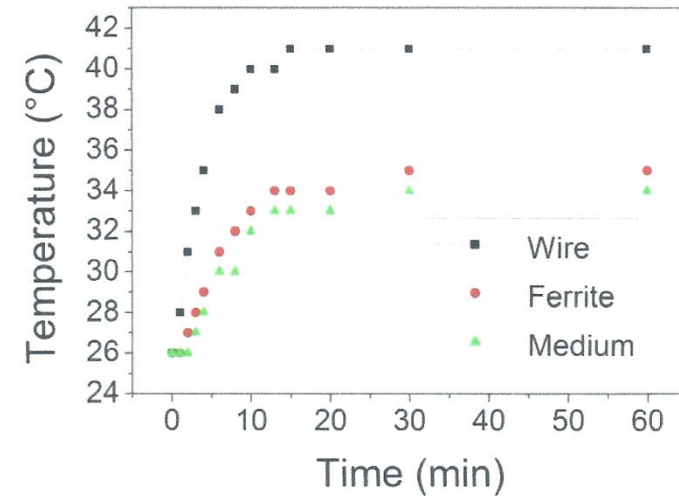
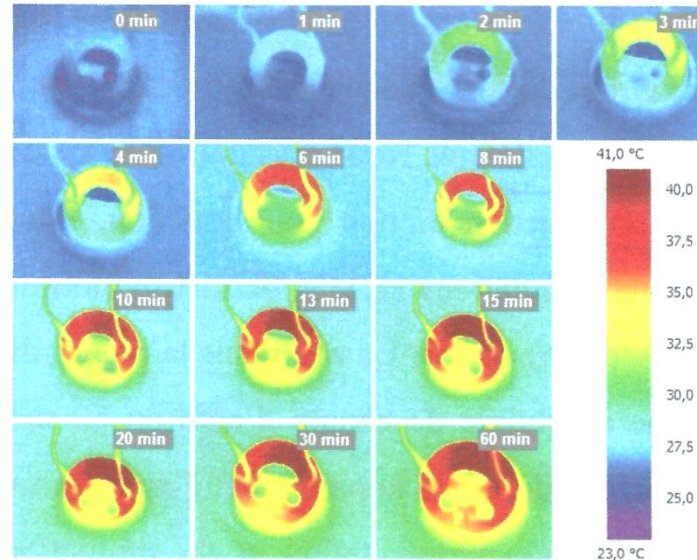

(a)

(b)

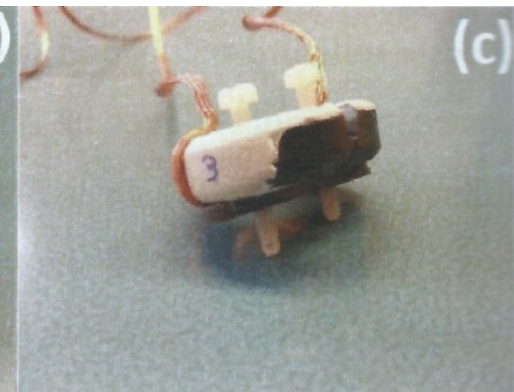
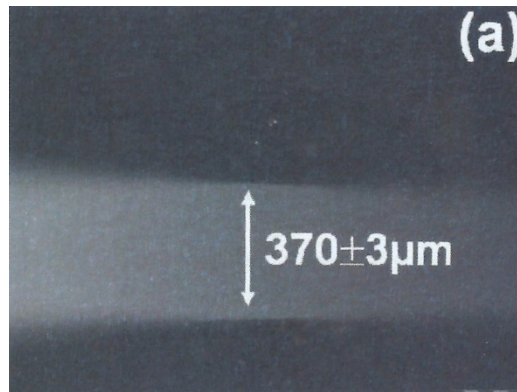

Nanotherics magneTherm™

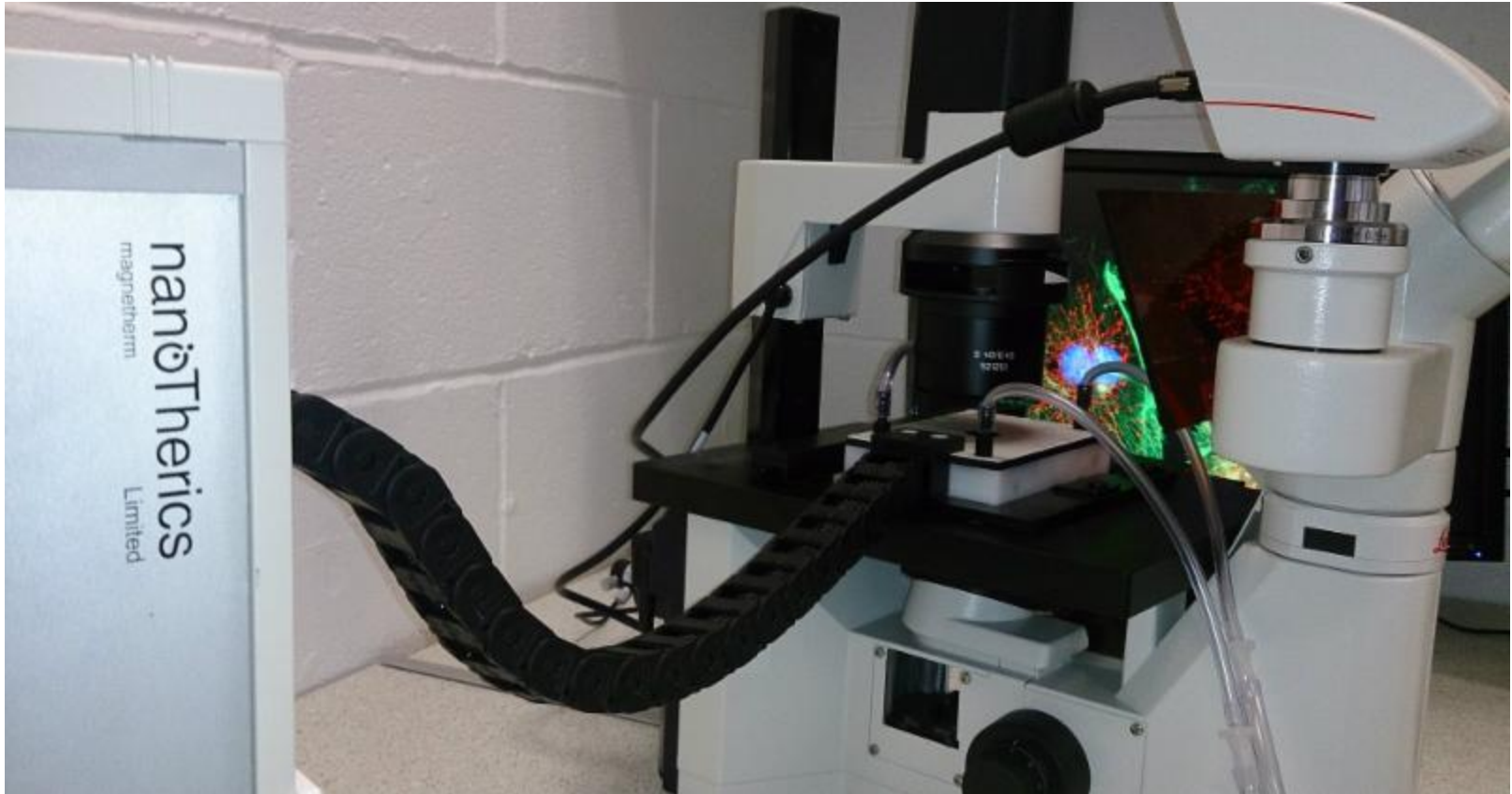

nanotherics
limited

Microscope stage:

Live Cell exposure system – 37 °C temperature controlled via water jacket, 5% CO₂ atmosphere

“Medical requirements for Magnetic Hyperthermia application” – Lisbon, April 16th 2015

Nanotherics magneTherm™

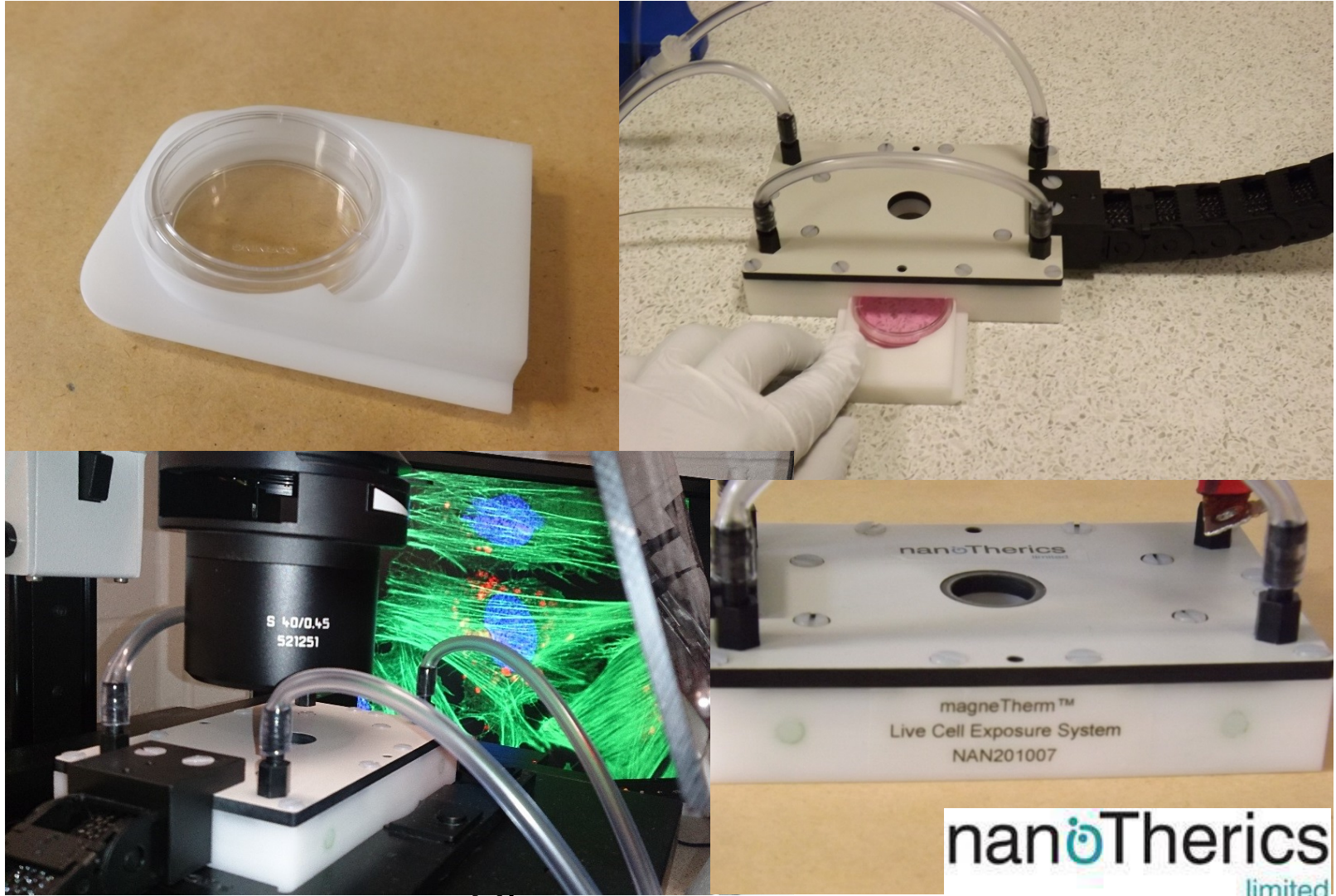

Microscope stage:

Live Cell exposure system – 37 °C temperature controlled via water jacket, 5% CO₂ atmosphere

“Medical requirements for Magnetic Hyperthermia application” – Lisbon, April 16th 2015

Thermometry methods

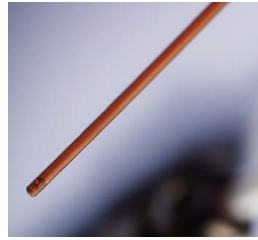

- ~~Thermocouple (Pt100)~~
- Fiber optic (AsGa crystal): Opsens™, Photon-control™, LumaSense™ ...
- Infrared thermometry: Optris™, Fluke™, VarioCAM™, Pyroview™, FLIR™, Infratec™, ... (but sensitive only to the surface-temperature)

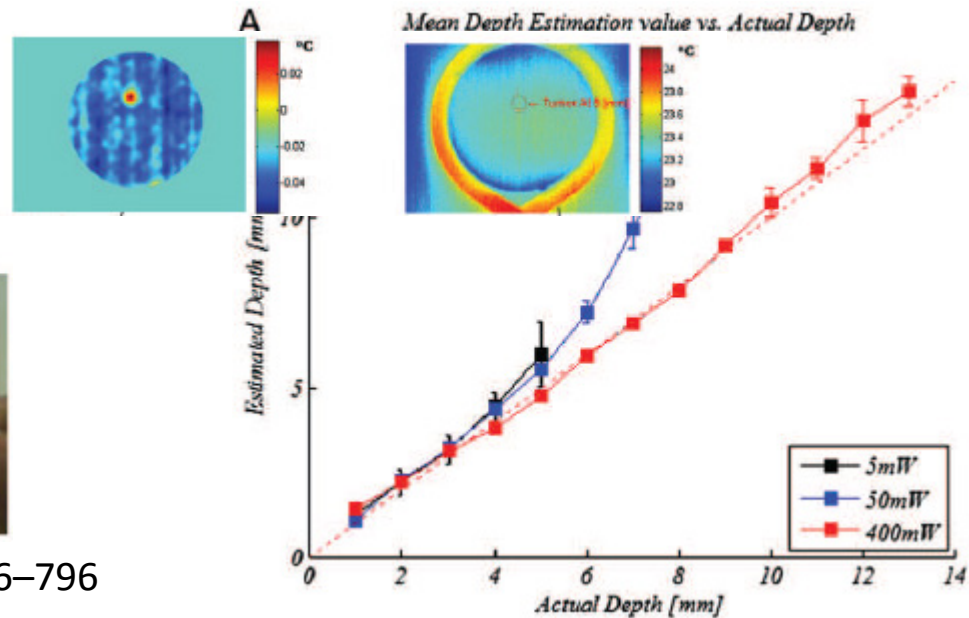
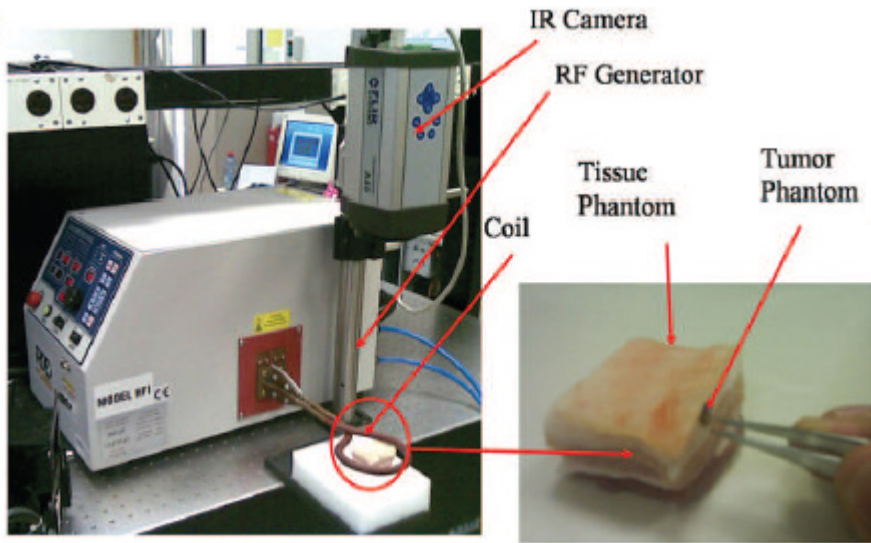

A. Levie et al, *Nanomedicine* 6 (2010) 786–796

- MRI: Proton Shift Frequency or T_1 -measurement (but not applicable near MNPs)
- Thermosensitive MRI contrast agents (thermosensible liposomes or polymers)
- Organic fluorescence dyes (Rhodamine, Cyanine...)
- Luminescent inorganic NPs (lanthanide dopants, upconverting particles...)

H field intensity/frequency measurement

→ a technical note will be written by WG4

- ~~Hall probes (work only up to 25-50 kHz)~~

- Current measurement directly on inductor coil
- Voltage measurement directly on inductor coil

} Need to compute inductance by FEM simulation

- Measured the electromotive force (e_{\max}) in a scout coil (Lenz induction law)

$$B(\text{Tesla}) \approx \frac{e_{\max}}{N \times S \times 2\pi f}$$

Mesure de l'induction dans une spire à
D=15cm (f=755kHz)

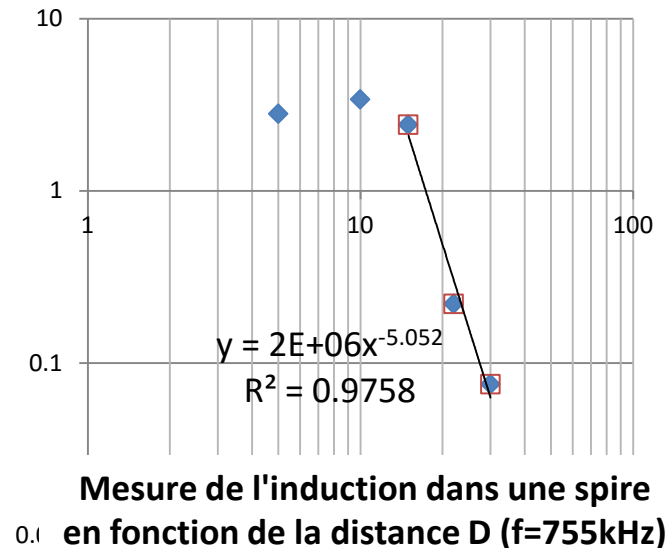
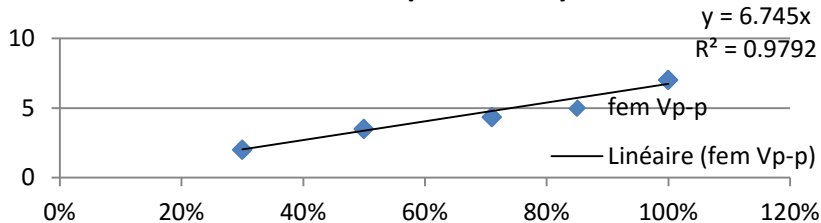

H field intensity/frequency measurement

→ a technical note will be written by WG4

• ~~Hall probes~~ (work only up to 25-50 kHz)

• Current measurement directly on inductor coil

• Voltage measurement directly on inductor coil

} Need to compute inductance
by FEM simulation

• Measured the electromotive force (e_{\max}) in a scout coil (Lenz induction law)

$$B(\text{Tesla}) \approx \frac{e_{\max}}{N \times S \times 2\pi f}$$

Mesure de l'induction dans une spire à
D=15cm (f=755kHz)

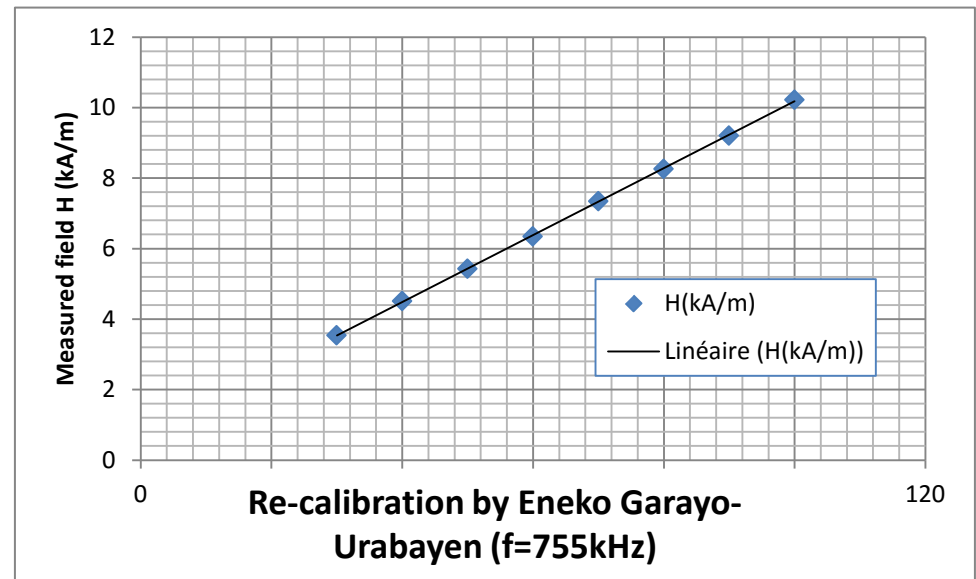
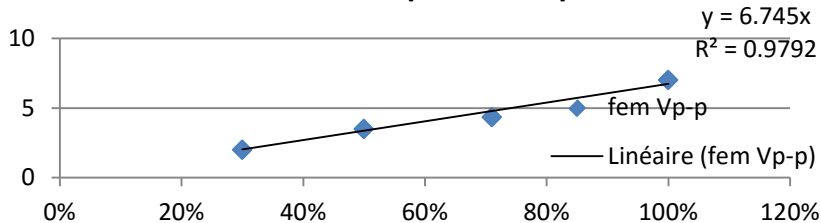

H field intensity/frequency measurement

→ a technical note will be written by WG4

- ~~Hall probes~~ (work only up to 25-50 kHz)
- Current measurement directly on inductor coil
- Voltage measurement directly on inductor coil
- Measured the electromotive force (e_{\max}) in a scout coil (Lenz induction law)

Need to compute inductance by FEM simulation

$$B(\text{Tesla}) \approx \frac{e_{\max}}{N \times S \times 2\pi f}$$

Need to maintain the coil geometry constant!

