



HAL
open science

Vitamine ENA: A framework for the development of ecosystem-based indicators for decision makers

Georges Safi, Diana Giebels, Nina Larissa Arroyo, Johanna Heymans, Izaskun Preciado, Aurore Raoux, Ulrike Schückel, Samuele Tecchio, Victor de Jonge, Nathalie Niquil

► To cite this version:

Georges Safi, Diana Giebels, Nina Larissa Arroyo, Johanna Heymans, Izaskun Preciado, et al.. Vitamine ENA: A framework for the development of ecosystem-based indicators for decision makers. *Ocean and Coastal Management*, 2019, 174, pp.116-130. <10.1016/j.ocecoaman.2019.03.005>. <hal-02152481>

HAL Id: hal-02152481

<https://hal.science/hal-02152481v1>

Submitted on 16 Dec 2020

HAL is a multi-disciplinary open access archive for the deposit and dissemination of scientific research documents, whether they are published or not. The documents may come from teaching and research institutions in France or abroad, or from public or private research centers.

L'archive ouverte pluridisciplinaire **HAL**, est destinée au dépôt et à la diffusion de documents scientifiques de niveau recherche, publiés ou non, émanant des établissements d'enseignement et de recherche français ou étrangers, des laboratoires publics ou privés.



HAL Authorization



Vitamine ENA: A framework for the development of ecosystem-based indicators for decision makers



Georges Safi^{a,b,*}, Diana Giebels^{c,d}, Nina Larissa Arroyo^{e,k}, Johanna J. Heymans^{f,g}, Izaskun Preciado^e, Aurore Raoux^a, Ulrike Schückel^h, Samuele Tecchioⁱ, Victor N. de Jonge^j, Nathalie Niquil^a

^a Unité Biologie des Organismes et Ecosystèmes Aquatiques (BOREA), MNHN, CNRS, IRD, Sorbonne Université, Université de Caen Normandie, Université des Antilles, CS 14032, 14000 CAEN, France

^b France Energies Marines ITE-EMR, 525 Avenue Alexis de Rochon, 29280 Plouzané, France

^c Erasmus School of Social and Behavioural Sciences, Erasmus University Rotterdam, P.O. Box 1738, 3000 DR Rotterdam, the Netherlands

^d Ecological Economics, Carl von Ossietzky Universität Oldenburg, Postfach 2503, 26111 Oldenburg, Germany

^e IEO, Instituto Español de Oceanografía, Promontorio de San Martín s/n, 39004 Santander, Cantabria, Spain

^f SAMS, Scottish Marine Institute, Oban PA37 1QA, UK

^g European Marine Board, Wandelaarkaai 7, Oostende 8400, Belgium

^h The Schleswig-Holstein Agency for Coastal Defence, National Park and Marine Conservation, National Park Authority, Schlossgarten 1, 25832 Tönning, Germany

ⁱ Sinay – Maritime Data Solutions, 117 Cours Caffarelli, 14000 Caen, France

^j Institute of Estuarine and Coastal Studies, University of Hull, Hull HU6 7RX, UK

^k Investalga Ahti S.L CDTUC, Avda. de Los Castros, 44. Local P-205, Fase A (E.T.S.I.), 39005 Santander, Cantabria, Spain

ABSTRACT

The Water Framework Directive (article 2, paragraph 21) as well as the Marine Strategy Framework Directive (MSFD, Descriptor 4) stress the need for assessing the quality of the structure and the functioning of ecosystems. The MSFD also underlines the urgent need for development, testing, and validation of ecosystem state indicators. Holistic function-based criteria and indicators as provided by Ecological Network Analysis (ENA) could be used to define and assess the 'Good Environmental Status' of marine ecosystems. This approach also feeds Ecosystem Based Management (EBM). ENA generally analyses the fluxes' quality of a single medium such as here the carbon fluxes in a food web and produces a number of useful metrics that indicate, *inter alia*, the total carbon flow through the system, the quality of the functioning of the system or the trophic efficiency of system. A short list of indices [*i.e.* Detritivory over Herbivory ratio (D/H), Connectance Index (CI), Transfer Efficiency (TE) over trophic levels, System Omnivory Index (SOI), Finn's Cycling Index (FCI), relative Redundancy (R/DC), Average Mutual Information (AMI) and Interaction Strength (IS)] is proposed for practical use. This paper presents a first framework for OSPAR Regional Sea Convention food web indicators based on ENA. These are presented here focusing on their applicability and what is needed for implementation, illustrating their potential use by case studies.

1. Introduction

1.1. The ecosystem-based approach for the management of marine ecosystems

The call for integrated or holistic approaches and ecosystem-based management (EBM) to the governance of our marine ecosystems is well-known and well-established (de Jonge, 2003, 2007; Borja et al., 2010; UNEP, 2011; Katsanevakis et al., 2011; de Jonge et al., 2012; Rodriguez, 2017; Oakley et al., 2018). The EBM philosophy stresses the necessity for decision makers to understand and decide upon entire ecosystems (Curtin and Prelezo, 2010) instead of food web subsets (de Jonge et al., accepted B) or independent species. Over the last two

decades, the European Commission has launched different directives fostering the implementation of ecosystem-based management in the European Union (van Leeuwen et al., 2014). The Water Framework Directive (WFD, article 2, paragraph 21) (EC, 2000) stresses the need for assessing the quality of the structure and the functioning of ecosystems. The Marine Strategy Framework Directive (MSFD; Descriptors 4) (EC, 2005a, b; 2008) mentions the urgency to develop, test and validate ecosystem state indicators. The ecosystem approach, including the assessment of food webs, is explicitly suggested in the MSFD as means to attain a 'Good Environmental Status' (GES) of marine ecosystems. The recent revision of the MSFD (EC, 2017) has even reinforced the importance of considering marine ecosystem structure, ecosystem functioning and other processes toward achieving GES.

* Corresponding author. Unité Biologie des Organismes et Ecosystèmes Aquatiques (BOREA), MNHN, CNRS, IRD, Sorbonne Université, Université de Caen Normandie, Université des Antilles, CS 14032, 14000 CAEN, France.

E-mail address: safigeorges@hotmail.fr (G. Safi).

<https://doi.org/10.1016/j.ocecoaman.2019.03.005>

Received 31 July 2018; Received in revised form 23 February 2019; Accepted 7 March 2019

0964-5691/© 2019 Elsevier Ltd. All rights reserved.

Further development of MSFD food web indicators should be directed towards more integrative or holistic and process-based ones (Rombouts et al., 2013; Tam et al., 2017). The view has emerged that holistic approaches are essential to account for the complexity, the dynamics, accumulated natural variation as expressed in the functioning and the structure of the biota and the additional effects of human interventions (see de Jonge et al., accepted B). Knowledge from the natural sciences is needed to understand and assess the state of an ecosystem. The knowledge of natural as well as the social sciences is needed to understand what changes took place due to what sort of interventions (e.g. engineering, fishing, sand mining, dredging, and drilling activities) and how human behaviour in combination with societal structures as well as laws may impact the ecosystem state and development potential both directly and indirectly (UNEP, 2011). This has been reiterated by the European Marine Board's newest Future Science Brief on ecosystem modelling, which calls for “making marine ecosystem models more relevant to management and policy by being more transparent about model limitations and the uncertainties in their predictions; including socio-economic drivers; promoting co-design and dialogue between model developers and users” (Heymans et al., 2018).

The call for holism seems, however, to be a bottleneck for both decision makers and scientists. In theory, EBM decision makers need knowledge that reflects interconnected social and ecological complexity for their step-by-step decisions in a process that fits the idea of adaptive management (Holling, 1978; Walters, 1986; Giebels et al., 2013). Evidence is growing that these principles are not easily implemented in practice. Although progress has been made, cases from Norway, Australia, US, Canada, Philippines, Japan, China and the European Union (Rodriguez, 2017; Giebels et al., 2016; Kirkman, 2013; Garces et al., 2013; Furukawa, 2013; Huang et al., 2013; Peng et al., 2013) show that problems remain when establishing holistic management regimes and when gaining holistic knowledge. Often, mono-disciplinary perspectives dominate the knowledge production and utilization process – such as in environmental impact assessments – evidencing difficulties in combining social and ecological approaches. Moreover, the socio-economic and ecological approaches cannot be combined or integrated easily. In practice, EBM also suffers from a lack of holistic description of each of its constituents (i.e. socio-economic and ecological perspectives). There is further a clear friction between what can be delivered in terms of ‘useful holistic indicators’ and what decision makers require in terms of ‘simple, easy to understand and affordable’ while the real situation is extremely complex when considering all the parameters such as the required monitoring, the data analysis etc. (see de Jonge et al., 2012). By fostering the call for such ecological indicators, so far the decision makers have not yet been able to create a holistic overview and perspective about the functioning of the entire ecosystem. Available indicators only reflect small parts of the ecosystem.

1.2. Ecological Network Analysis (ENA): a promising method for a holistic ecological perspective under contemporary European Directives

Ecological Network Analysis (ENA) is a systems ecology oriented methodology to analyse all fluxes (e.g. carbon flow or nutrient or energy transfer) among all constituents of a food web. It is used to identify holistic properties that are otherwise not evident from direct observations (see Fath et al., 2007). ENA aims to characterize, *inter alia*, the functioning of food webs, i.e. the complex flow of matter or energy between groups of organisms in an ecosystem (Niquil et al., 1999). ENA allows (1) assessing the functioning of food webs based on the analysis of the interactions among the living (biological compartments) and the non-living (carbon pools) components; (2) identifying the most important trophodynamic links between compartments at the species level or functional group level; (3) identifying limiting resources and keystone species in a food web; (4) analysing and identifying the main energy flows within a food web; and (5) analysing the effect of specific pressures on the biomass distribution of specific food webs (e.g. Baird

and Ulanowicz, 1989; Wulff et al., 1989; Ulanowicz, 1986, 1997, 2004; Libralato, 2008; Baird et al., 2012; Heymans et al., 2014, de Jonge and Schückel, this volume).

Over the past 40 years, ENA has been demonstrated to be a promising tool to capture and assess the complexity of ecological systems with the potential to bridge the ecological and socio-economic systems (de Jonge, 2003; de Jonge et al., 2012; Borrett et al., 2018). Therefore, here we start to build a framework to integrate food web indicators as potentially valid measurements of aspects related to critical ecosystem characteristics such as ecosystem status. In the WFD (EC, 2000) the Ecological Status is defined as “an expression of the quality of the structure and functioning of aquatic ecosystems associated with surface water, classified in accordance with Annex V” (WFD Article 2, paragraph 21). The purpose of the ENA indices is to conduct an integrative, holistic and also unambiguous assessment of the status of marine ecosystems by analysing their functioning. Studies are required (see e.g. de Jonge and Schückel, this volume) to establish the effects of specific pressures on quantitative shifts of species biomasses for specific (parts of) ecosystems and if possible its effect on indices representing the system ‘functioning’. This is now the main challenge. However, recent years have seen studies tackle this challenge in a context of a wide variety of pressures such as fisheries (Bentley et al., 2017; Corrales et al., 2017; Serpetti et al., 2017; Preciado et al., 2019), invasive species (Baird et al., 2012; Corrales et al., 2017), port extensions (Tecchio et al., 2016), offshore wind farms (Raoux et al., 2017), eutrophication in terms of time (Schückel et al., 2015) and finally also the effects of human interventions such as dredging (changing light conditions) and loads of organic waste (de Jonge and Schückel, this volume).

Once the assessment is available, these ENA indices can be used in the decision-making process at the appropriate scale, i.e. local, regional, national and/or international scale. This scale-transferability is an important asset for contemporary EBM implementation in the European Union. It allows decision makers in a variety of governance settings to apply the indices. EBM approaches are typically emerging as processes of regional governance, urging cooperation and integration across actors representing most diverse public and private institutions as well as governance scales (Giebels et al., 2013; van Leeuwen et al., 2014; Soma et al., 2015; Oakley et al., 2018). Hence it is important to develop indices that can speak to a variety of governance levels. Furthermore, we know from survey research (see Hendriksen et al., 2014), that actors responsible for EBM implementation in European seas under the umbrella of MSFD prefer tailor-made solutions rather than standardized one-size-fits-all approaches when implementing EBM. Although the ENA framework needs to be built on standardized procedures and protocols to calculate ecosystem state, it does so using what is known about the regional entities of an ecosystem. The regionally calculated state index can thus be used as an additional knowledge input (= Vitamine ENA) for a decision-making process that might also use other calculations and approaches.

If already existing monitoring programs are adapted to the requirements set by the ENA application, these indices can also serve the long-term monitoring of ecosystem state. Indices that deviate from their reference that reflects the optimum ecological situation, should then be a reason for investigating the effects of human activities (e.g. pollution, constructions, loads or organic waste, dredging, fisheries) that translate to quantitative shifts in species abundance or biomass and thus a change in the indices' mean value. At the end, policy makers should be offered the possibility to test experimentally the effects of measures in terms of index or metrics values. That means that they would then have a tool where they can change the stresses or the foreseen measures so that the index under consideration reaches a desired value. The value of the different ENA indicators informs policy makers and managers about the required development direction in a process that can be indicated as ‘adaptive ecosystem management’. The challenge is to use the indices as reference while establishing the optimum ecological situation for a given case.

1.3. Aim of paper

Ecological Network Analysis indices are numerous and each ENA index describes different aspects of the food web. In this paper, eight indices are presented [*i.e.* Detritivory over Herbivory ratio (D/H), Connectance Index (CI), Transfer Efficiency (TE) over trophic levels, System Omnivory Index (SOI), Finn's Cycling Index (FCI), relative Redundancy (R/DC), Average Mutual Information (AMI) and Interaction Strength (IS)] which reflect the outcome of European experts' work and discussions on ENA in the context of the OSPAR Commission between 2011 and 2017. The paper describes the potential of ENA indices to be incorporated in general management strategies in order to give a holistic assessment of the status of marine ecosystems as intended within MSFD, WFD or Regional Sea's conventions programs. This is done by presenting a first framework for OSPAR Regional Seas Convention food web indicators based on ENA, explaining what these selected ENA indices calculate, highlighting what needs to be incorporated for example in monitoring programs and what needs to be understood to start using these indices in global assessment evaluation programs and illustrating results using different case studies.

2. The ENA methodological framework

2.1. Building the network

Food webs, or ecological networks, are simplified representations of functional species interactions in a certain geographical area and setting. Food webs are thus diagrams that depict compartments (species, functional groups and carbon/nutrient/energy pools) as nodes and their interactions represented as edges. The abstracted set of connections can represent an ecosystem, community or habitat.

Ernst Haeckel not only coined in 1869 the term “ecology” but he also introduced the concept of “patterns of eating and being eaten” or in a more recent and popular fashion as patterns of “*who eats whom or what and how much*” (Pimm, 1982). Ulanowicz (2004) split the formulation by Pimm (1982) into two questions: (1) who eats whom?, and (2) at what rate? The first of the two needs to be extended as “Who eats whom or what?”: it refers to the non-living pools (detritus) which play a major role in the functioning of ecological networks. Prior to the first question, it is necessary to identify the significant taxa (species or functional groups) comprising the living part of the ecosystem. Once that information is available, the system can be presented graphically as a diagram (Fig. 1-A), where each transaction is represented as an arrow that originates from the (to be eaten) prey taxon node or detritus and terminates (with an arrowhead) at the predator node.

Ecosystems are open, meaning that they exchange material and energy with their surroundings. These exchanges are represented by three kinds of arrows: (i) Exogenous inputs to the ecosystem (e.g. primary production, transport of nutrients, POC or DOC or immigration), which is represented by an arrow that originates out of no visible taxon and terminates (with an arrowhead) into the actual receiving node (Fig. 1-B); (ii) Exogenous outputs from the ecosystem, which is the export of material or energy still useful for other ecosystems of comparable scale (e.g. physical transport of POC and or DOC, emigration of species or harvesting by humans), and represented by an arrow that originates from the given taxon but terminates in an empty space referring to surrounding ecosystems (Fig. 1-B); and (iii) Exogenous dissipation of energy: that part of the exogenous output that may be dissipated into mainly respiration, and is represented by arrows directed to the ground as ground wire (striped arrowhead) (Fig. 1-B). The second query “at what rate?” invokes linear matrix algebra to analyse network patterns in a systematic fashion. To do so, a single medium (e.g. organic material expressed in organic carbon, wet mass, energy, or other chemical elements such as N and P) is required to express flows. Then, literature or local measurements are used to define metabolic rates of each compartment (e.g. the total consumption/demand by the

population or organisms can then be estimated). Given the scarcity of some chemical elements such as N and P, in the biosphere, it is inevitable that the same material be used repeatedly by many of the biological species. This is called “recycling” of the medium and is quantified also in the network construction, by cyclic pathways. Finally, the model can be balanced in order to force fluxes to have the same property for each compartment *i.e.* sum of entering fluxes = sum of exiting fluxes. It is worth noting that the choice of balancing procedure can influence the ENA indices (see Odum, 1969, 1973, Polovina, 1984, Allesina and Bondavalli, 2003, Fath et al., 2007, Jørgensen et al., 1999, de Jonge and Schückel, this volume for more details).

Once the ecosystem network has been constructed, the performance of the system as a whole can be evaluated by using ENA indices. These indices represent the nature of the connections between compartments through an analysis of several types of fluxes in comparison to the total flux through the system, the trophic structure based on a linearization of the network and the degree of redundancy or specialization of the flows (Ulanowicz, 1986, 1997, 2004; Fath et al., 2007; Saint-Béat et al., 2013). The levels of both anthropogenic and natural stress of aquatic ecosystems on the functioning of the ecosystem is then captured by the ENA indices (Heymans et al., 2014; Tecchio et al., 2016, de Jonge and Schückel, this volume).

2.2. Algorithms to calculate ENA indices

ENA indices are based on an instantaneous estimate of the value of each flow type within the food web. This estimate is generally calculated based on annual averages by different algorithms (e.g. Ecopath, NETWRK, enaR). Today, to our knowledge, five different software tools are available which can calculate ENA indices, namely NETWRK (Ulanowicz and Kay, 1991), Ecopath with Ecosim or EwE (Christensen and Pauly, 1992), R package NetIndices (Soetaert, 2009), R Package EcoTroph (Colléter et al., 2013) and R package enaR (Borrett and Lau, 2014; Lau et al., 2015). Several methods have evolved recently to allow the estimation of uncertainty intervals using the ENA-tool for Ecopath (Guesnet et al., 2015), LIM-MCMC for the Linear Inverse Modelling (R package limSolve, van der Meersche et al., 2009), the ENA uncertainty function implemented in enaR (Hines et al., 2018) and linking LIM with enaR (R package FlowCAR, Waspe et al., 2018). Considering the uncertainty around each input value is the most used approach to begin this estimation. Then, the application of the linear equations of the model transfers this uncertainty to the output unknowns – *i.e.* the flows – and, from them, to the values of the ENA indices. Thanks to this uncertainty intervals determination, it is now possible to test the statistical significance of the difference between two values, describing two situations for the same index (Tecchio et al., 2016, Raoux et al. in press), for example by comparing the impact of an event by comparing before and after situations. The uncertainty analyses, implemented in enaR, have also recently been used to compare the impact of differences in diet input on the calculation of food-web indices such as FCI and others (Bentley et al., 2019).

2.3. Data requirements

The first step prior to calculating the ENA indices is the construction of the model for the targeted ecosystem (Odum, 1973; Pimm, 1982; Ulanowicz, 2004). The complexity of the model (e.g. the number of species or compartments included, the level of aggregation of species in the trophic compartments, the spatial resolution, etc.) is strongly related to data availability and to the policy question that needs to be answered. However, whatever the complexity of the model that is built, any local system's specific information based on ENA is highly appreciated because it provides an indication on the status of the local food web. In general, the plankton biomass (*i.e.* phytoplankton, micro-phytobenthos on the intertidal flats/sediment bed plus its re-suspended fraction and micro-meso- macro-zooplankton) is required along with

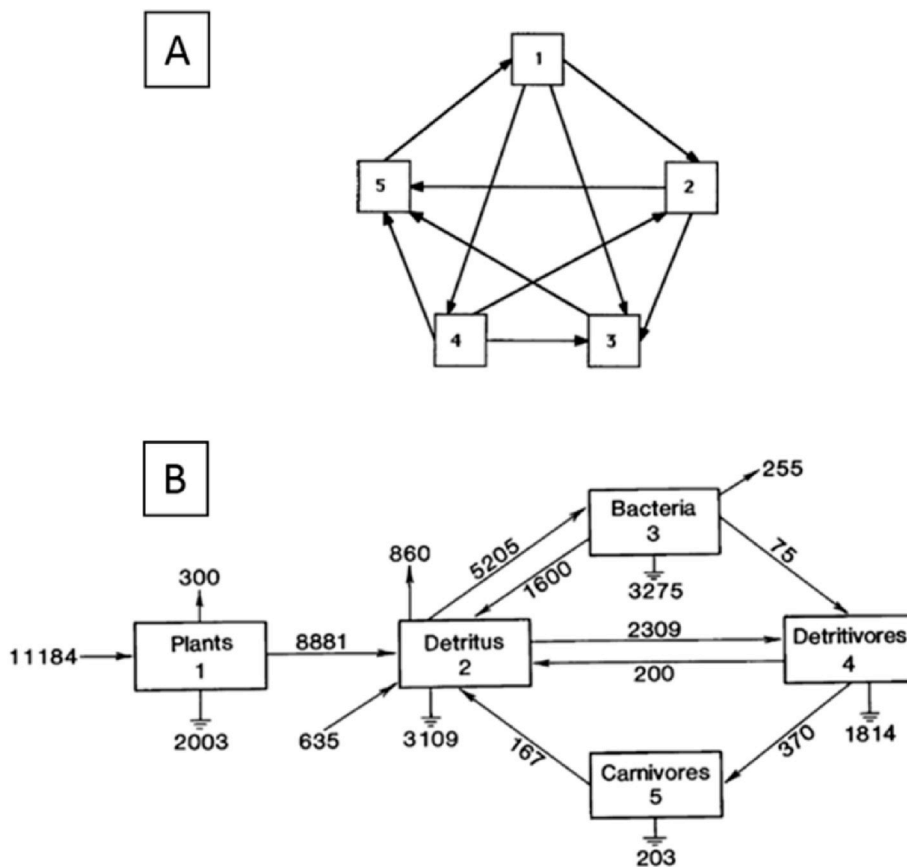

Fig. 1. Schematic representation of the information required for the Ecological Network Analysis indices. A- A directed flow graph; B- The trophic exchange of here energy ($\text{kcal.m}^{-2}.\text{y}^{-1}$) but it could also be in organic Carbon ($\text{gC.m}^{-2}.\text{y}^{-1}$), nitrogen, or even wet weight. The arrows not originating from a box represent exogenous inputs, arrows not terminating in a box portray exogenous outputs and ground symbols represent mainly respiration. Figures are from Ulanowicz (2004).

bacteria, benthic organisms, fish and invertebrates, mammals, and bird biomass data (Saint-Béat et al., 2013, 2015, de Jonge et al. accepted A,B). Information on the organisms < 1 mm (e.g. algae, microzooplankton, meiofauna, bacteria) can be essential for the analyses (de Jonge et al., accepted B). If this information is not locally available, literature from ecosystems expected to be close to the studied ecosystem can be helpful to estimate the biomasses although this will introduce unknown uncertainty in the model.

The food web is normally characterized by biomass values of a single medium such as the carbon biomass values of the compartments. To gain a better understanding of the strength of the relationships occurring within a food web, a measure of the amount of carbon (or energy/nutrient) needed from each prey item is required. Stomach content and stable isotope analyses are used to account for these measures (see as examples Velasco et al., 2003; Le Loc'h et al., 2008, Jennings and Molen, 2015). The quantity of a specific prey in the stomach of a predator and/or the isotope signature is then a proxy of the strength of the link between predator and prey (Arroyo et al., 2017).

Once this information is available, the model can be parameterized with biomasses per unit area, with all the required ratios of processes over biomass [such as production over biomass ratios (P/B, usually determined as mean per annum), consumption over biomass ratios (C/B, as mean per annum) or respiration over biomass (R/B) and egestion (E/B)] and a diet matrix which establishes the interactions between predators and preys in the ecosystem. Whatever the modelling approach, a system of assumed linear relations (equations) between total food intake and the relative importance of certain prey species will then lead to fluxes of prey food per species. As a result, a rectangular $n \times n$ matrix containing all flows is obtained which forms the basis for the ENA analysis (e.g. Fath et al., 2007).

3. Applying ENA indices under regional cooperation towards EBM approach

3.1. ENA indices as guidelines to advise on regional monitoring programs: the OSPAR case

Strongly institutionalized management regimes have the advantage of long-term institutional existence and stability. They can typically build up and upon extensive databases, integrating monitoring parameters and efficiently advising to decision-making through institutionalized procedures. Regarding such databases, ENA indices are increasingly considered to be useful to develop and operationalize monitoring parameters accounting for holistic systems ecological approaches at large temporal and spatial scales.

The OSPAR commission represents such a long-term institutional entity (www.ospar.org). Based on the OSPAR convention it represents an international cooperation for the North East Atlantic marine environmental protection, and an international structure by which EU Member States, sharing marine regions or sub-regions, can cooperate to ensure that the MSFD's objectives are achieved. Within OSPAR, the necessary actions on each step of the marine strategy can also be coordinated. Following the adoption of the MSFD (EC, 2008), EU Member States are required to cooperate to ensure the coordinated development of marine strategies. Member states are encouraged to conduct joint assessments of their shared waters to obtain coherent and integrative perspectives of their environmental status.

Ecological Network Analysis are among the OSPAR indicators (OSPAR FW9 indicator). The holistic rationale behind ENA, capturing functional aspects of the food web, rather than only fish and commercial species (Rombouts et al., 2013), led to its inclusion as a potential food web indicator in the OSPAR list of indicators (Table 1). So far, under the OSPAR framework, the Intersessional Correspondence Group

Table 1

OSPAR Food Web (FW) list of indicator descriptions (Niquil et al., 2014a). FW3 and FW4 are currently adopted as common indicators in some of the OSPAR regions. These indicators are applied in the OSPAR 2017 intermediate assessment (<https://oap.ospar.org/en/ospar-assessments/intermediate-assessment-2017/>). The rest of the indicators (i.e. FW1, FW5, FW6, FW7, FW8 and FW9) are still candidate indicators, for which development work is ongoing, or which are under consideration for potential future development for EU MSFD Descriptor 4. FW2 is the only candidate indicator that contributed partially to the OSPAR 2017 intermediate assessment. For more details, see www.ospar.org.

OSPAR indicators code	Indicator descriptions
FW1	Reproduction success of marine birds in relation to food availability
FW2	Production of phytoplankton
FW3	Size composition in fish communities
FW4	Changes in average trophic level of marine predators
FW5	Change of plankton functional types (life form) index ratio
FW6	Biomass, species composition and spatial distribution of zooplankton
FW7	Biomass and abundance of functional groups
FW8	Changes in the distribution of biomass and species over trophic levels and body size
FW9	Ecological Network Analysis

for Coordination of Biodiversity Assessment and Monitoring (ICG-COBAM) proposed a list of nine indicators (Table 1) to capture food web characteristics (i.e. structure, functioning and dynamics) (Niquil et al., 2014a).

To date, however, only fisheries related indicators [i.e. Size Composition in Fish Communities, (Typical Length, OSPAR FW3 indicator) and Mean Trophic Level (MTL, OSPAR FW4 indicator)] are currently adopted as common indicators (Table 1). The Typical Length indicator, represents the average length of fish and is expected to decline in response to high fishing pressure as fishing is a size-selective process (Boudreau and Dickie, 1992; Rossberg, 2012; Fung et al., 2013). The MTL gives information on the structural changes in the ecosystem as a result of fishing (Pauly et al., 1998). However, although these two indicators describe some important features of the ecosystem (i.e. fish, elasmobranch and invertebrates) and are used for assessing the environmental status in OSPAR regions, they do not provide the “holistic” view as desired or foreseen by the political will and the intention of the directives (e.g. EC, 2008, 2017).

OSPAR, by functioning as one of the advisory commissions on the supranational level could provide further “experimental room/opportunity” for ENA approaches to become operationalized at larger regional scales. This space can be seized to close existing data gaps via monitoring and to develop ecologically robust assessment models. The supranational level of OSPAR as advisory body to the EU Commission presents an important advantage as national constraints do not directly influence or compete (e.g. competition between the ministries of economy and nature protection; monitoring cut backs due to financial crisis; fragmentation of the administrative system due to reforms; lack of cooperation between administrations; lack of common monitoring standards because of administrative fragmentation).

3.2. ENA indices proposed by the food web experts under the OSPAR ICG-COBAM group

ENA indices are numerous and each describes different aspects of the food web. In this section, eight indices are presented as listed in Table 2. These indices are proposed as a first set of ENA indices to be considered under the “OSPAR FW9 indicator” (Table 1). The eight indices reflect the outcome of the ICG-COBAM Food Web expert working group between 2011 and 2017. Their function is here restricted to a graphical representation and description of what the different indices represent in a network plus the equations and the theoretical meaning underneath.

3.2.1. Detritivory/herbivory (D/H)

3.2.1.1. *Description of the index.* Detritivory and Herbivory reflect the transfer of carbon (or energy, nutrients) from detritus and/or autotrophs (e.g. plants) to level II (i.e. to detritivores and herbivores,

respectively) in a food web (Odum, 1969; Kay et al., 1989; Ulanowicz, 1992; Niquil et al., 2014b). A detritivore increases recycling (Saint-Béat et al., 2013), in parallel with the microbial loop, which plays an important role in marine ecosystems (Odum and Heald, 1975; Heymans et al., 2002). Thus, an ecosystem that shifts from high Detritivory to low Detritivory is less dependent on Detritus (Fig. 2), and more dependent on plant material (phanerogams and/or algae) for the transfer of energy from level I to level II (Luong et al., 2014).

3.2.1.2. *What are the implications of varying D/H for food web status?* High D/H values reflect an ecosystem where detritus plays an important role in the medium recycling such as carbon recycling, while low D/H reflects an ecosystem where primary producers (phytoplankton and/or algae) play a vital role as food for the second level (Luong et al., 2014; Chrystal and Scharler, 2014, de Jonge et al., accepted A). An increase in the D/H ratio indicates a shift to a more detritus-based food web. The reasons for a shift can be several. Odum (1969) relates the increase in Detritivory to the maturity of ecosystems. Following experiments with computer models, detritus-based systems seem to be more stable and show higher resilience than ecosystems based solely on primary production (Lassalle et al., 2011). However, observations on real life ecosystems show that disturbances may increase the D/H in situations like a flood event in an estuary (Niquil et al., 2014b), eutrophication (Schückel et al., 2015), in a salt-marsh disturbed with high stress conditions (Dame and Christian, 2007) and with high waste loads (de Jonge and Schückel, this volume).

3.2.2. Connectance Index (CI)

3.2.2.1. *Description of the index.* Connectance is a measure of network complexity and can generally be defined as the number of actual interactions in a food web divided by the total possible number of interactions or links – essentially the density of interactions in binary networks (Martinez, 1991; Warren, 1994; Christensen and Walters, 2004; Banasek-Richter et al., 2009). Going from high CI towards low CI (Fig. 3) is represented by a loss of pathways or edges between compartments. Naturally stressed ecosystems, such as estuaries, show low CI values (Lobry et al., 2008). CI also decreases under stressing conditions such as fishing impacts (Eddy et al., 2017).

3.2.2.2. *What are the implications of varying CI for food web status?* Stability increases with the number of links in a food web, and therefore the higher the CI, the more stable and robust the food web (Rooney and McCann, 2012). Studying the CI is important for ecologists wishing to understand what determines the stability of a community. However, by its very definition, CI is strongly correlated with the level of aggregations considered in the system (Martinez, 1991). It is thus important to restrain its use for comparing systems with the exact same level of aggregation.

Table 2

List of ENA indices proposed in the OSPAR Convention context. This list is not adopted by OSPAR Commission at the date of writing this paper. It only reflects the current discussions between Food Web experts in the context of the OSPAR ICG-COBAM Food Web working group.

ENA indices	Symbol	Definition and calculation	Literature
Detritivory over Herbivory ratio	D/H	Importance of living trophic interactions compared to detritus chain. D/H is a simple ratio where Detritivory corresponds to the sum of all predation flows (i.e. flows from detritus to consumers) on the detritus compartment, and Herbivory represents the flows of predation on plants. The connectance index (CI) is measured following the equation $CI = L/S^2$ where L is the actual number of links and S^2 represents the number of possible links (S being the number of species).	Kay et al. (1989), Ulanowicz (1992), Baird et al. (2009).
Connectance Index	CI	where L is the actual number of links and S^2 represents the number of possible links (S being the number of species).	Martinez (1991), Warren (1994)
Transfer Efficiency over TLs	TE	Proportion of outbound flows of a discrete trophic level that throughput into the next. TE is calculated as the fraction of the total carbon input to a given level that is transmitted to the next higher level. The overall transfer efficiency of the system is then derived from the logarithmic mean of the efficiencies of the trophic levels.	Lindeman (1942), Baird and Ulanowicz (1989)
System Omnivory Index	SOI	Mean of consumers' omnivory indices, weighted by the logarithm of their consumption.	Christensen and Pauly (1993), Christensen and Walters (2004), Libralato (2008)
Finn's Cycling Index	FCI	Finn Cycling Index can be calculated by the total cycling throughflow (Cycled flow of node i is $TSTci = ((ni - 1)/ni)Ti$) divided by total system throughflow (TSTflow): $FCI = \frac{\sum TSTci}{TSTflow}$	Odum (1969), Finn (1976, 1980, 1983)
Relative Redundancy	R/DC	Proportion of internal flows overhead on total development capacity. R/DC is calculated $\frac{R}{DC} = \sum_{i,j=1}^n Tij \log_2 \left[\frac{Tij^2 T_{j..}}{Ti. T_{.j}} \right] / \sum_{i=1}^{n+2} \sum_{j=0}^n Tij \log_2 \left(\frac{Tij}{Ti. T_{.j}} \right)$ Where Tij is the flow from compartment i to compartment j; Ti. is the sum of all flows leaving compartment i; T.j is the sum of all flows entering in compartment j; T. is the sum of all flows.	Ulanowicz (1986), Christensen (1995), Ulanowicz (2001), Saint-Béat et al. (2013)
Average Mutual Information	AMI	Measures the organization of the exchanges between compartments. AMI is calculated with the following formula: $AMI = k \sum_{i=1}^{n+2} \sum_{j=0}^n \frac{Tij}{T.} \log_2 \left(\frac{Tij T_{.j}}{Ti. T_{.j}} \right)$ Where Tij is the flow from compartment i to compartment j; Ti. is the sum of all flows leaving compartment i; T.j is the sum of all flows entering in compartment j; T. is the sum of all flows.	Hirata and Ulanowicz (1984), Latham and Scully (2002)
Interaction Strength	IS	The formula for interaction strength between a predator and a particular prey item is: $lij = mij/imij$ formulated as the diet contribution (mij , in biomass or volume) of species i to the diet (gut content) of consumer species j	McCann (2000), Arroyo et al. (2017)

3.2.3. Transfer efficiency (TE) over trophic levels

3.2.3.1. Description of the index. The basic process in trophic dynamics is the transfer of carbon (or energy, nutrients) from one trophic level to another (Lindeman, 1942; Odum, 1973; Kay et al., 1989). All functions and indeed all forms of life within an ecosystem depend upon the utilization of an external source of energy such as solar radiation (Lindeman, 1942). Phytoplankton production is the first process where light energy is used to convert relatively simple resources into complex organic substances. Lindeman (1942) was first to define transfer “efficiency” (TE) for each trophic level as the percentage of the production of one trophic level converted to production by the next trophic level. The shift from high to low TE (Fig. 4) is reflected by an increase in the time duration for energy to transfer from low trophic

compartments (e.g. level I) towards higher ones (e.g. level IV) (Odum, 1973).

3.2.3.2. What are the implications of varying TE for food web status?. A high value of TE is characteristic of a mature ecosystem or of an oligotrophic ecosystem with scarce element (Lobry et al., 2008; Scharler et al., 2015). However, it is important to note that TE is related to the type of ecosystem described, as Heymans et al. (2014) showed that TE is significantly different in ecosystems of different average depths (i.e. shallow estuaries vs. deep sea ecosystems that include the water column), so for management purposes, it is best to only compare TE within a system, not across systems. Disturbances of various origins (e.g. species invasions, Baird et al., 2012;

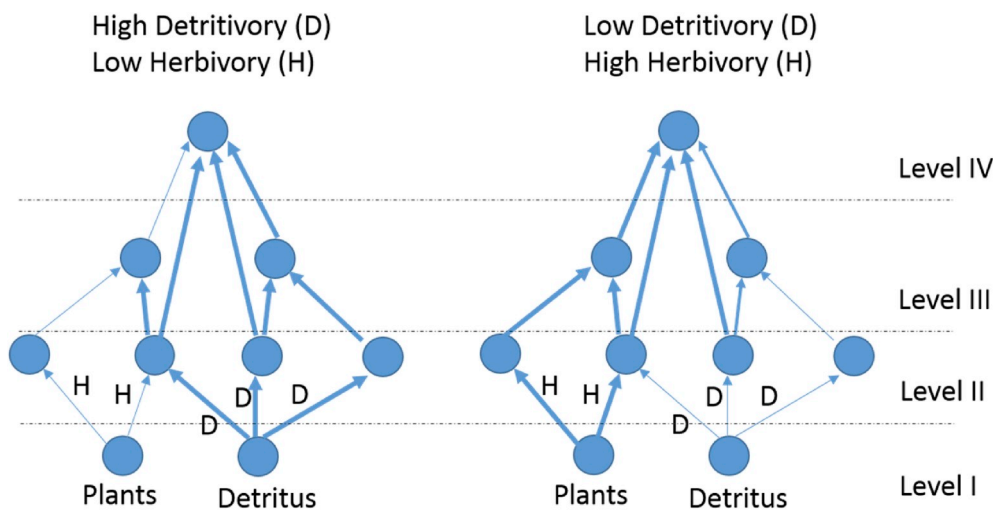

Fig. 2. Schematic representation of the concept of Detritivory (D) and Herbivory (H).

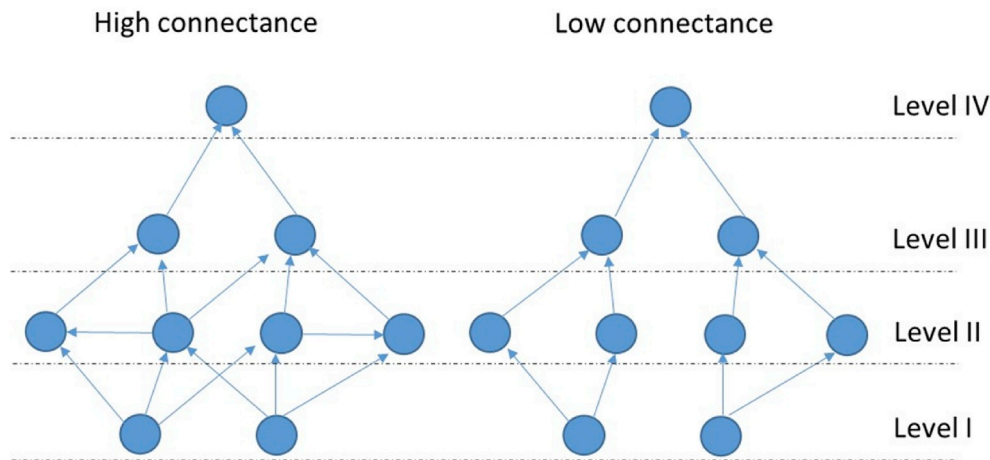

Fig. 3. Schematic representation of the concept of food web Connectance (CI).

eutrophication, Libralato et al., 2004) have been shown to lower the ecosystem TE. In different case studies it has been demonstrated that there is a correlation between higher fishing pressure levels and lower TE (Libralato et al., 2008; Coll et al., 2009; Heymans et al., 2012). However, the phenomenon is not a systematic one as indirect effects may lower the efficiency of some trophic levels but increase the mean efficiency as estimated at the ecosystem level (Duan et al., 2009).

3.2.4. System Omnivory Index (SOI)

3.2.4.1. *Description of the index.* Omnivory in the common sense is understood as the practice of feeding on more than one type of food sources such as detritus, plant material or fauna. Libralato (2008) presented the System Omnivory Index (SOI) as a mean index that quantifies the distribution of feeding interactions among trophic levels of the food web through the weighted average of omnivory of the consumers (Christensen and Pauly, 1993, Christensen and Walters, 2004, Libralato, 2008). Omnivory is then defined as the variability of trophic levels of preys. Going from higher to lower SOI mean values represents (Fig. 5) the transitional shift from a food web with a wide web-like structure (i.e. with several pathways and omnivory relationships between compartments/species) to a narrower chain-like structure (i.e. with fewer pathways and a structure consisting of several simplified food chains) (Dimitrios et al., 2018).

3.2.4.2. What are the implications of varying SOI for food web

status?. Omnivory increases the complexity of food webs and therefore, SOI represents an overall measure of the complexity of a given ecological network, allowing comparison among ecosystems and for assessing their development stage and maturity (Lobry et al., 2008). SOI has been often applied as a quantification of the web-like structure of weighted and directed food webs (Libralato, 2008), and it has also been described as a relevant indicator of stress (Lobry et al., 2008; Selleslagh et al., 2012). SOI has been shown to decrease with the level of fishing pressure (Heymans et al., 2012). As omnivory gives flexibility to the system, more omnivorous systems are able to absorb perturbations and to recover quicker after them (Fagan, 1997; Libralato, 2008). And, according to Fagan (1997), an increase in the degree of omnivory may have a stabilizing role on the system.

3.2.5. Finn's cycling index (FCI)

3.2.5.1. *Description of the index.* Christensen and Walters (2004) described the cycling index as the fraction of an ecosystem's throughput that is recycled, i.e. that is circulating in cycling pathways (forming loops). FCI quantifies the importance of cycling in the system (Finn, 1976) and is presented as the percentage of flows generated by cycling. Going from high FCI towards low FCI is represented by the reduction in the number of cyclic pathways within the food web (Fig. 6) or the reduction in the flow value within those cycling pathways (Finn, 1976, 1980; Scharler and Baird 2005; Tecchio et al., 2015).

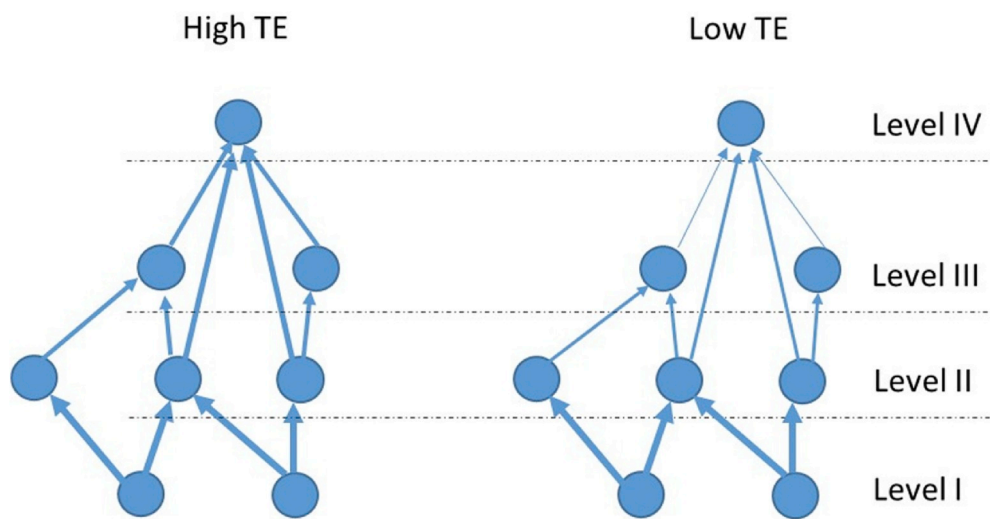

Fig. 4. Schematic representation of the concept of transfer efficiency (TE).

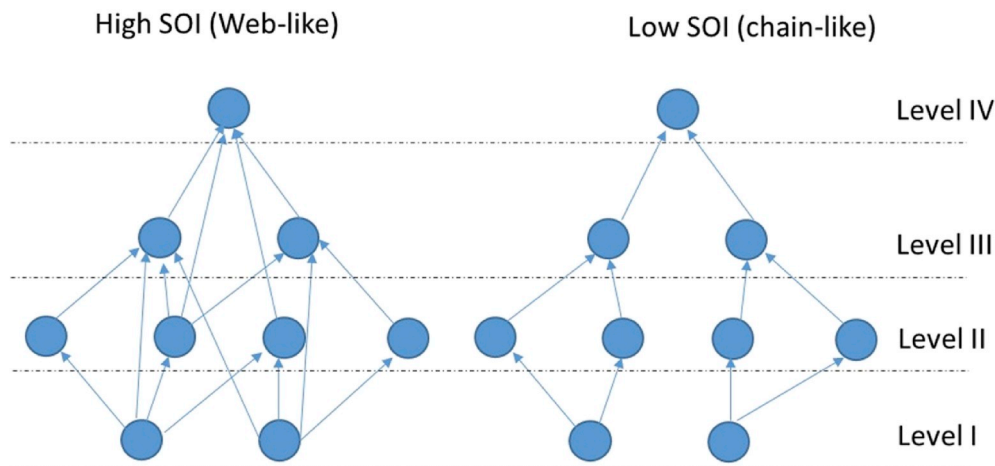

Fig. 5. Schematic representation of the concept of System Omnivory Index (SOI).

3.2.5.2. *What are the implications of varying FCI for food web status?* The FCI is often considered as a possible indicator of stress and an increase in recycling is usually interpreted as a response to stress (Odum, 1985; Scharler and Baird 2005; Tecchio et al., 2015; Pezy et al., 2018). However, cycling can also act as a buffer during perturbation and increase the ability of the system to resist changes, increasing its resistance (Sain Béat et al., 2015). The consideration of the recycling as an indicator of stress must also be adapted to the hydrological features of the studied system. This is especially true for estuaries, where the strong influence of physical factors such as hydrodynamics should be accounted for when interpreting FCI results (Niquil et al., 2012, de Jonge and Schückel, this volume).

3.2.6. *Relative redundancy (R/DC)*

3.2.6.1. *Description of the index.* Relative redundancy (R/DC) measures the extent to which internal flows within a food web follow parallel pathways. Thus, R/DC decreases as the food web's specialization increases, i.e. the food web becomes more dependent on one of the sources as for example a source from level I (Fig. 7) or from another level (Ulanowicz, 1986). Considering only internal flows means excluding export, import, and dissipation flows from the calculation, and focusing uniquely on prey-predator interactions (Tecchio et al., 2016). Hence only internal flows are considered in the R/DC calculation.

3.2.6.2. *What are the implications of varying R/DC for food web status?* R/DC corresponds to an indicator of the inefficiency of the network (Hirata and Ulanowicz, 1984; Bondavalli et al., 2000; Saint-

Béat et al., 2013) as it measures the number of parallel trophic itineraries connecting the different trophic compartments, but it is also a way for ecosystems to show a high resilience as one pathway can replace another one (Ulanowicz, 1997). It has been shown as sensitive to persistent ecosystem changes such as overfishing combined with acute impacts such as temperature fluctuations (Heymans and Tomczak, 2016; Tomczak et al., 2013).

3.2.7. *Average mutual information (AMI)*

3.2.7.1. *Description of the index.* The Average Mutual Information (AMI) is a measure of how efficiently material is transported through the network (Rutledge et al., 1976; Hirata and Ulanowicz, 1984; Latham and Scully, 2002). AMI measures the organization of the energy exchanges between compartments/components of a food web and thus reflects the system's overall organization. A rise in AMI signifies that the system is becoming more constrained and is channelling flows along more specific pathways. Lower values of AMI mean a system evolving towards a web-like network, while a higher value indicates an increase in specialization/constraints (Fig. 8) (Ulanowicz, 1997, 2004).

3.2.7.2. *What are the implications of varying AMI for food web status?* Historically, ecosystems were theorized to tend for higher efficiency (higher AMI) throughout succession, but currently it is foreseen that systems with excessive (high AMI) or too little efficiency (low AMI) are less likely to persist (Ulanowicz, 2009; Ludovisi and Scharler, 2017). AMI values are highest in networks where there are fewer pathways for energy to get to the top trophic

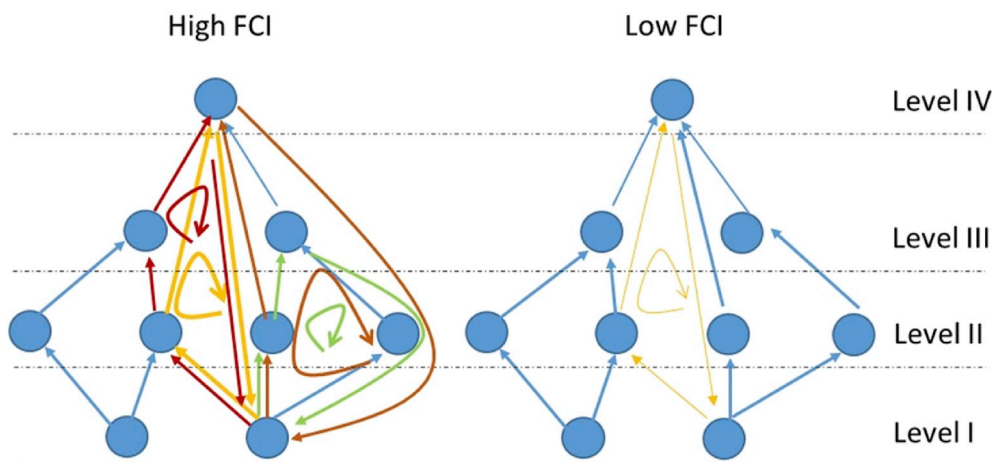

Fig. 6. Schematic representation of the concept of Finn's Cycling Index (FCI). In the left part (High FCI), the number of cyclic loops and their magnitude is higher which reflects a higher amount of material that is circulating within/among loops. The different loops are presented with different colours. (For interpretation of the references to colour in this figure legend, the reader is referred to the Web version of this article.)

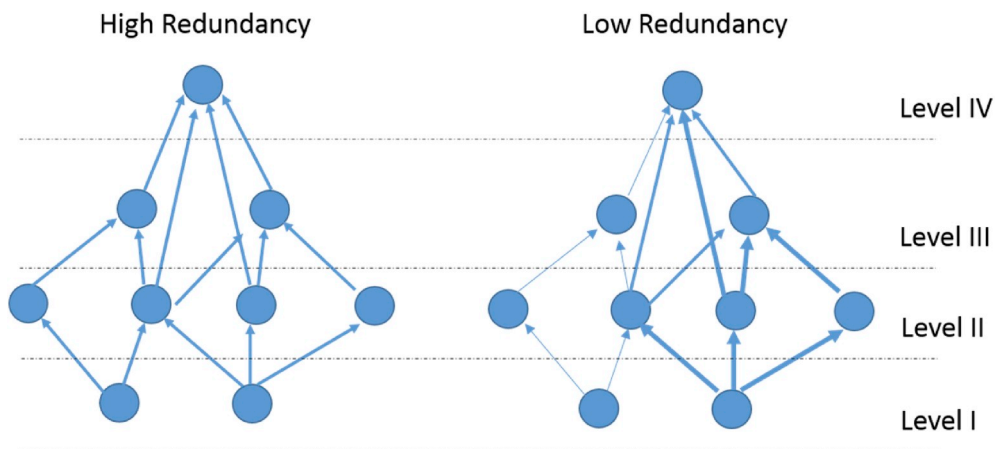

Fig. 7. Schematic representation of the concept of food web Relative Redundancy (R/DC).

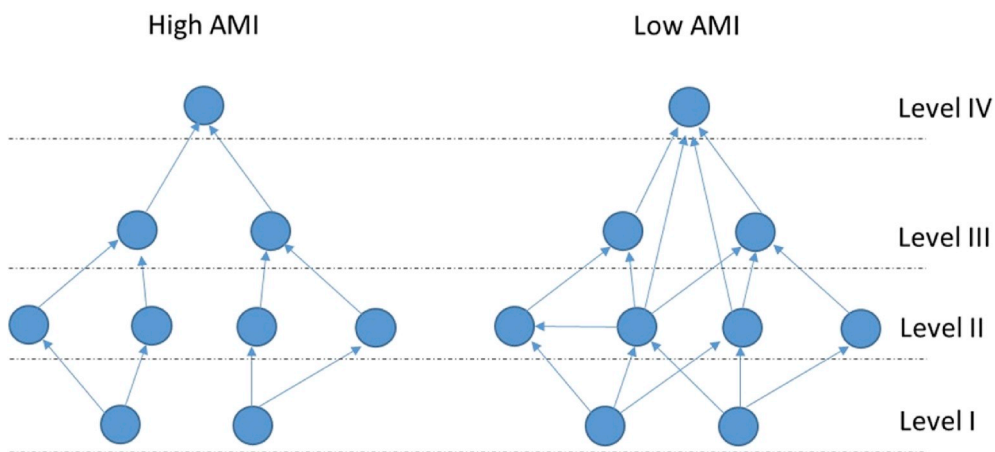

Fig. 8. Schematic representation of the concept of Average Mutual Information (AMI).

levels, and lowest in networks that are fully connected and all links transport an equal amount of material (Ulanowicz, 1980, 2009).

3.2.8. Interaction strength (IS)

3.2.8.1. Description of the index. The Interaction Strength ($a_{i,j}$) of species j on species i , is generally defined as the per capita measure of the instantaneous rate of population change of species i owing to a change in species j . This can be interpreted as the rate of biomass flux between species j and i (e.g. the IS, in terms of biomass flux, of predator j on prey species i is the per capita functional response) (Rooney and McCann, 2012). The relationship can be assimilated to the biomass of prey species i consumed by predator/consumer species j (Fig. 9), and thus the calculation of IS between these elements be based on diet analysis of the various predator/consumer species conforming a specific food web (Velasco et al., 2003; Le Loc'h et al., 2008). From the obtained values, a mean (and a variance) of the IS for that specific food web can be obtained (Arroyo et al., 2017).

3.2.8.2. What are the implications of varying IS for food web status?. The distribution of IS in nature is such that there are many weak links and few strong interactions, various theoretical and empirical studies showing this stabilizing effect in the species relationship (McCann, 2000; Kokkoris et al., 2002; Gellner and McCann, 2012). In general, a decrease in the mean and the variance of IS within a food web is a sign of increasing stability, and thus, of an increased resistance/resilience of the system to perturbations (McCann, 2000; Gellner and McCann, 2016; Arroyo et al., 2017).

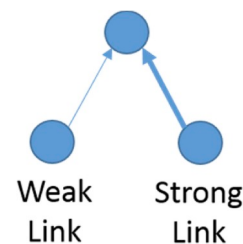

Fig. 9. Schematic representation of the concept of Interaction Strength (IS).

4. Applying ENA indices: a promising approach to satisfy the decision makers quest for ecosystem-holism in management

4.1. Bottlenecks for administrative and political implementation of ENA indices

When it comes to Ecosystem Based Management (EBM) implementation, the scientific quest for holism typically overlaps with the political-administrative quest for holism. In organizational terms, EBM implementation requires “[...] management actions across a range of spatial scales and attention to connections among spatial as well as governance units” (Lester et al., 2010). These connections need to be driven by cooperation and integration to result in effective management regimes (see Soma et al., 2015). Simultaneously, EBM requires decision makers to work at clearly defined local levels “As structures and functioning of ecosystems are diverse and formed at the local levels so too must

management be varied and be tailored to the characteristics of each specific location.” (Curtin and Prelezo, 2010; Oakley et al., 2018).

The level of available knowledge is an important factor often restricting decision maker's possibilities to apply good knowledge for decision-making (Tallis et al., 2010). The analysis and comparison across contemporary practice of successful EBM knowledge governance revealed that decision makers have applied a variety of practices to organize knowledge for decision-making, but still struggle to incorporate ecosystem-holism (Giebels and de Jonge, 2014). The following cases show that Ecological Network Analysis is a promising approach in that respect, because it can be applied for decision-making to satisfy the quest for ecosystem-holism in a variety of organizational contexts.

4.2. Case studies reflecting the (potential) benefits of applying ENA indices

4.2.1. Ecological implications of the EU landing obligation and fishing mortality

In the context of the reformed Common Fisheries Policy (EC, 2013), the landing obligation of all fisheries catches including discards was implemented. Dimitrios et al. (2018) assessed the ecological implications of the EU landing obligation on the Ionian Sea food web. Simulations showed that discards are cascading up the food web and changes in the management of discards lead to significant consequences for top organisms (mainly marine seabirds) especially when applying this regulation without any change in the fishing effort. However, the Ionian Sea food web seemed to be not impacted by the application of the landing obligation as the main commercial fish species showed low biomass changes. This was enhanced by the estimated values of the ecological indicators, including ENA indices (TE, FCI, CI and SOI), in which no deviations were observed from the initial condition. The overall low impact of changes in discarding policy is due to the fact that most of the species groups did not rely on the small amounts of discards estimated for the Ionian Sea. The Ionian Sea is described as a mature system (Finn, 1976), presenting a good resistance to unexpected perturbations (Ulanowicz and Norden, 1990) with a food web with a high web-like structure having the highest SOI values compared to other Mediterranean systems (Piroddi et al., 2015, 2016).

Fishing mortality, and particularly overfishing, can have impacts on ecosystem functioning. Eddy et al., (2017) studied the ecosystem effects of invertebrate fisheries by analysing twelve ecosystem models worldwide. These authors demonstrated the important role of invertebrates in marine ecosystems and that their exploitation can have strong ecosystem impacts with a reduction in ecosystem connectance (CI). Generally, exploitation of cephalopods had the greatest impacts across the twelve studied ecosystems, with more than 20% of other groups affected by a 40% biomass change in cephalopods at high exploitation levels. Cephalopods had the highest CI values and low relative abundance indicating their strong predatory role in the various studied ecosystems and thus, underlying their top-down regulation role in these ecosystems. Overall, Eddy et al., (2017) concluded that relative abundance and CI of exploited invertebrate groups were good predictors of ecosystem impacts.

Further effects of overfishing and ecosystem's recovering trends after the enforcement of fisheries regulations were recorded by Arroyo et al. (2017) in the Cantabrian Sea. Here, fishing reached its peak intensity during the 90's causing the mean trophic level of the catches to reach minimal levels (Sánchez and Olaso, 2004). Nowadays, an increasing body of evidence indicates that the system seems to be on a recovery trend after the enforcement of quotas and fisheries regulations. In this study, consumer network structure (i.e. all trophic levels above primary producers, all consumers) variations were used over a 22 year period (1992–2013), together with species and functional group indicators, to investigate the extent to which biological diversity and functionality have been restored in this area with the reduction in fishing pressure. Arroyo et al., (2017), showed that trends of increased

species richness and diversity of functional groups were paralleled by an increase in links per species and a reduction in the mean and the variance of interaction strengths (IS) between the main consumer species and their potential prey, indicating a progression towards increased stability of the benthic-demersal assemblages in this area, in accordance with ecological theory. Specifically, while the role of strong interactors as keystone species is well established, weak interactors have important stabilizing roles as buffering agents in production transfer processes (de Ruiter et al., 1995, O'Gorman and Emmerson, 2009), allowing the co-existence of many species and adding stability to the system (McCann and Rooney, 2009). These results provide additional evidence on how network structure analyses may provide a convincing tool for evaluating and monitoring both impacts and recovery trends in well-sampled ecosystems.

Another example of how ENA can be applied was shown in the northern Benguela ecosystem (Heymans and Tomczak, 2016). Here ENA analysis showed how fishing and the environment (most likely) combined to re-organize the ecosystem. Heymans and Tomczak (2016) showed with ENA indices how the structure of the ecosystem had evolved between 1956 and 2003. The large fishing effort that occurred in this ecosystem before the mid-1970's combined with the Benguela Niño (a lack of upwelling and increased sea surface temperature due to changes in wind patterns) in 1972 changed the internal structure of the ecosystem (reflected by an increase in the Average Mutual Information (AMI) index). This change in the internal structure, combined with another Benguela Niño in 1984 which caused very low primary production, created a regime shift which was as a statistically significant reduction in the redundancy (R/DC), when the system abruptly changed. This was manifested in a large change in the most important fished species, with the ecosystem changing from a system dominated by pelagic fisheries, to one dominated by demersal species, and the pelagic energy flowing through species that cannot be fished such as jellyfish and gobies (Utne-Palm et al., 2010). Heymans and Tomczak (2016) suggested that the system should now be managed as one with reduced redundancy, thus imposing a reduced fishing pressure. A similar regime shift in the ecosystem due to changes in the exploitation and nutrients was also shown in the Baltic Sea by Tomczak et al. (2013), and in this case the reorganization (changes in the redundancy; i.e. R/DC) in the ecosystem was shown to last about 10 years.

4.2.2. Harbour construction and offshore wind farm: building hard structures at sea

The study of Tecchio et al. (2015, 2016) shows how ENA can be developed as an add-on to the use of environmental impact assessment to better understand the impacts of big national infrastructure projects at the local level. Tecchio et al. (2015, 2016) investigated the effect on the local ecosystem of a commercial port extension at Le Havre, in the Seine Estuary (Northern France). ENA indices were applied, integrating the ecological data from years 1996–2002 (before the port extension – Tecchio et al., 2015) with those from 2005 to 2012 (after the port extension – Tecchio et al., 2016). Results showed that the two habitats with a functioning most related to a stressed state were the northern and central navigation channels, where building works were a-priori considered major anthropogenic stressors. Modelling the response of the various habitats separately permitted disclosing the specific response of the functioning properties of the food web to the different pressures. After the port construction on the northern flank of the Seine estuary, results showed a food web with an increased detritivory (D/H) and carbon recycling (FCI), which possibly regressed to a previous step in ecological succession.

In addition to the local level, ENA is also useful to describe impacts at the regional scale. Raoux et al. (2017, in press) investigated the applicability of ENA indices in the context of offshore wind farm construction in the French EEZ. An Ecopath ecosystem model was built composed of 37 compartments, from the bacterial compartment, which is at the lowest trophic level, up to seabirds' compartment, among the

high predators. The model describe the situation “before” the construction of the wind farm (Raoux et al., 2017). Then, an Ecosim projection over 30 years after the building of the wind farm was performed, increasing the biomass of targeted benthic and fish compartments subjected to reef effect (Raoux et al., In Press). ENA indices were calculated for the two periods, “before” and “after”, to compare network functioning and the overall structural properties of the food web. Simulation results showed that the carbon recycling (FCI) and the system omnivory (SOI) indices as well as the Detritivory/Herbivory ratio (D/H) increased after the construction of the offshore wind farm (Raoux et al., 2017).

4.2.3. The effects of nutrient enrichment on marine ecosystems

Luong et al., (2014) assessed the effects of continuous nutrient additions on the structural and functional dynamics of a marine planktonic ecosystem combining data from mesocosm experiments with carbon budget modelling and ENA indices. Increasing nutrient additions showed a food web restructuring with a decrease in TE as the food web efficiency was reduced implying that more net primary production was required to produce the same biomass of copepods. The authors relate the decrease in food web efficiency to inadequate food quality, reduced assimilation efficiency and reduced growth efficiency. Nutrient enrichment also promoted herbivory (i.e. decreasing the D/H ratio) which resulted in a decrease in recycling (i.e. decrease in FCI). Hence, under high nutrient addition rates, food webs show a higher degree of utilization of primary production compared to detritivory.

4.2.4. Potential use of ENA for improving habitat restoration efforts: an endangered Danish fish species

Denmark's second largest river restoration project was organized alongside the goal to restore the habitat of an almost extinct fish species, the Danish Houting (*Coregonus oxyrinchus*). This river restoration project was managed by a regime that worked very well to organize decision-making quickly and timely, successfully bridging all of the most necessary institutional boundaries on the regional, the national as well as the supranational level. The quest for knowledge-holism however was a big challenge here and more difficult to be achieved than expected. Since the Danish Houting was almost extinct and not much scientific knowledge was available about the species, the production and use of knowledge was an ongoing quest throughout the decision-making. Decision makers approached this problem by producing and aligning knowledge step by step (see Giebels et al., 2015 for further details).

Although the restoration project as such is finalized by now, the lack of biological knowledge implies continuing research and management questions. Different studies have been conducted, for example investigating reproduction patterns, migration behaviour and habitat requirements (Jensen et al., 2015) as well as impact of predators on mortality (Jensen et al., 2017). Jensen's et al. (2015 and 2017) research results, although not directly mentioning the use of ENA, imply the usefulness of ENA indices as additional decision-making guidance for future conservation actions. The measurement of Interaction Strength could for example be used as an indicator to better understand and estimate predation risk. Jensen et al. (2017) found that predation pressure by cormorants (*Phalacrocorax carbo sinensis*), increased in the project's region due to the establishment of artificial lakes. Accordingly, for future restoration decisions it would be important to understand whether cormorant predation is likely to become a settled pressure within regionally located food webs or whether indices would rather predict that predator-prey relationships are less stable and hence likely to change.

The advantage of ENA is that it accounts for single species and prey-predator interactions through the inclusion of all relevant processes that influence the successfulness of individual species in relation to their ecosystem. Calculated factors like mortality rate, food availability and intake, diet composition and respiration that stem from and impact

upon the species itself, but can also account for indirect effects such as migrating species. Using ENA as an overall measurement of ecosystem state through the combined use of indicators, like proposed throughout this paper, can then become useful to calculate very regional threshold values while not neglecting the external influences that typically impact upon geographical areas as well.

5. Discussion

Environmental managers who neglect ecosystem-level structures and functioning run the risk of taking decisions that might lead to even higher costs in the long-term. The consequences might be a deterioration of ecosystem state, which includes degradation of its provided services and, thus, high restoration and reparation costs. Using an indicator-based representation of ecosystem-dynamics based on Ecological Network Analysis (ENA) is considered here as a potentially helpful tool in that respect. Although the application of the approach is still in its infancy, the current paper shows why and how ENA can strengthen ecosystem-holism for decision-making application.

ENA indices can be applied at all scales, from global (Heymans et al., 2014), regional (de la Vega et al., 2018, de Jonge et al., accepted A, B) to local scales (Tecchio et al., 2015, 2016; Pezy et al., 2017; Raoux et al., 2017). The selection of ENA indices can be conducted under Regional Seas Conventions, such as the OSPAR Convention, and other international arenas when considering a regional approach. Important is that the EU Commission supports a situation where European Member States work together to produce new and solid common indicators towards an increased coherence in the implementation of all the relevant (existing and new) European Directives while enhancing joint monitoring programs through collaborative efforts.

In this context, the OSPAR/ICG-COBAM food web experts worked together between 2011 and 2017 to propose a “short list” of ENA indices [i.e. Detritivory over Herbivory ratio (D/H), Connectance Index (CI), Transfer Efficiency (TE) over trophic levels, System Omnivory Index (SOI), Finn's Cycling Index (FCI), relative Redundancy (R/DC), Average Mutual Information (AMI) and Interaction Strength (IS)] to foster the common efforts between Member States. The selection of these indices is based on the (1) experts judgment of the high sensitivity of these indices to capture changes occurring in marine food webs, (2) the potential of these indices to be easily communicated to policy-makers and stakeholders and (3) the complementarity of the indices in describing the functioning of ecosystems, which is an important quest emerging from European Directives. The complementarity of these indices is related to their historical evolution. During the 20th century, the understanding of ecosystem functioning started with a linear chain-like thermodynamic vision (Elton, 1927; Lindeman, 1942). This vision evolved afterwards from a chain-like vision towards a web-like vision (MacArthur, 1955; Odum, 1969). This is related to the fact that the importance of omnivory has been discovered (Odum, 1969). The other important element is detritivory (Wiegert and Owen, 1971), i.e. the entry of the energy into the ecosystem is not only due to primary production (herbivory). This new concept of web-like ecosystem functioning required thus the characterization of omnivory (SOI) as well as herbivory and detritivory (D/H), but also recycling (FCI), which is a crucial process within this complex web-like vision (Finn, 1976, 1980; Kay et al., 1989; Ulanowicz, 1992; Christensen and Pauly, 1993). The pyramidal vision of the food web and its functioning led to the calculation of transfer efficiency (TE) between the different trophic levels of the food web (Lindeman, 1942; Baird and Ulanowicz, 1989). Food web efficiency is however also related to the network structure and complexity, which refers to the concepts of connectance (CI), average mutual information (AMI) and to relative redundancy (R/DC) (Hirata and Ulanowicz, 1984; Martinez, 1991; Christensen, 1995). R/DC is also related by the theories of information to the system robustness with the idea, which is originally from MacArthur (1955), that the loss of one element can be replaced by another (Ulanowicz, 1986). However, other

more recent approaches to stability have led to interest in the equilibrium between interaction strength (McCann, 2000).

The political quest for indicators that would capture the food-web functioning (EC, 2008; EC, 2017) led several groups of researchers to coordinate their answers to this demand by publishing their work in the context of EU collaborative projects (e.g. Devotes, Lynam et al., 2016; Piroddi et al., 2016), ICES groups (Tam et al., 2017), or the OSPAR food web group (Rombouts et al., 2013). The current paper reflects the recent coordinated work of the OSPAR/ICG-COBAM food web group. However, collaborations between researchers and decision makers are still ongoing. During a recent workshop of Ecological Network Analysis experts on invitation of the Schleswig-Holstein Agency for Coastal Defense, National Park and Marine Conservation and the Alfred-Wegener-Institut (Schückel et al., 2018), there was a concerted effort to determine how to reach a broader audience, specifically environmental managers and decision makers, with network tools and perspectives. Fath et al. (this issue) proposed a complementary set of ENA indices [i.e. Average Path Length (APL), FCI, D/H, Mean Trophic Level (MTL), Keystoneness, Structural Information and Flow-based Information indices]. Although two common indices - FCI and D/H - emerged between Fath et al. and the present paper, additional indices are proposed by Fath et al. The MTL is an indicator that has also been fostered by OSPAR/ICG-COBAM food web experts but as a separate food web indicator (i.e. not in the ENA indices short list). The reason for that is to allow its application using a multiple set of data sources (such as International Bottom Trawl Survey data or fisheries landing data) and not only using modelling outputs (Arroyo et al. in press, Safi et al. in prep). In line with these works and as result of the EcAprHA project (European Union's DG ENV/MSFD/Action Plans 2014), Preciado et al. (2019) concluded that MTL can be a good indicator to monitor changes in food web structure with a direct response of a manageable pressure such as fishing. They also confirm that the impact of bottom trawling spreads through benthic-demersal food webs, the intensity of its effects being directly related to the intensity of fishing in a specific area at small-scale spatial resolution. The MTL is already used by the OSPAR commission to conduct regional environmental status assessments (www.ospar.org). Fath et al. proposed flow-based information indices which actually include several indices among which AMI and R/DC are found, and also A/DC (relative ascendancy) and Φ /DC (relative overhead). APL, Keystoneness and structural information are also important features to characterize food web functioning. This is achieved by investigating the amount of system activity generated by each unit input into the system (APL, Finn, 1976), identifying species that play a particular role that is fundamental in structuring an ecosystem or exerts a strong impact on its function (Keystoneness, e.g. Valls et al., 2015) and describing the information embedded in network composition (Structural Information, Ludovisi and Scharler, 2017).

According to Cash et al. (2003) knowledge that has the potential to impact upon decision-making needs to be credible, salient and legitimate at the same time. The coordinated work of OSPAR/ICG-COBAM reveals that the request for the development of ENA indices has been supported by decision makers themselves, indicating that in particular the salience criterion is fulfilled. Further implementation of ENA to the ecosystem approach should be via so-called adaptive management policy and practice (Holling, 1978; Rogers et al., 2000; Curtin and Prellezo, 2010; de Jonge et al., 2012; Wasson et al., 2015) as to reveal whether ENA indices will also be able to achieve credibility and legitimacy. Adaptive management is essentially 'learning by doing' with policy and practice being constantly monitored and re-oriented as experience is gained during implementation. Such an approach accepts the inherent complexities and uncertainties that often shroud the utilization of marine resources. Fath et al. (this volume) ENA indices and the indices proposed in this paper are complementary. However, the final selection of ENA indices should be kept as an adaptive process to increasing knowledge acquisition by conducting experimental testing on ENA. For instance, one of the main challenges encountered by some

ENA indices is their sensitivity to multiple pressures that are not always related (e.g. fishing pressure and climate change). Numerical experiments will help disentangle pressures and quantify resilience/resistance in terms of specific pressures. It is also imperative that multiple models, calculating the indicators for the same ecosystem should be undertaken, such as is done in the climate modellers, as is suggested in the Future Science Brief on Ecosystem Modelling (Heymans et al., 2018). Exploring pressure/state relationships can be overcome by using numerical experiments to mimic controlled perturbations once appropriate models of specific ecosystems are defined (e.g. Raoux et al., 2017 for the simulation of an offshore wind farm impact). By realizing such numerical experiments, additional knowledge is acquired on the ENA indices which could lead, in the adaptive management policy and practice context, to update the ENA lists at the various scales.

ENA indices are conceptually powerful and have shown their capacity of detecting changes in ecosystems as presented in this paper. However, these indices might be sensitive to the effect of cumulated pressures. Thus, two major steps would need to be investigated in future work to cope with the knowledge gaps. The various pressures effects on ENA indices need to be studied (1) separately, and (2) under multi-pressure conditions (the cumulative effects). The mathematical and statistical dependence of indices between each other's should also be investigated in future work (see as an example Niquil et al., 2012; Tomczak et al., 2013; Kazanci and Ma, 2015).

6. Conclusion

The selection of a set of ENA indices as presented in this paper was largely done within the framework of the OSPAR food web working group. This kind of reflection exists also in other working groups and it is important to be able to share the points of view and the knowledge between groups. The main purpose of this paper is to present ENA indices functioning, in a simple way with concrete case studies, to draw attention of stakeholders and decision makers on the potential of these indices to reach Ecosystem Based Management (EBM). EBM requires also bridging ecological and socio-economical approaches which is potentially achievable by mean of ENA indices. The case studies presented in this paper are used to show the variety of contexts in which ENA indices can be applied and to show also a case study where ENA indices would have been useful for EBM application.

This paper also underlines the importance of progressing work on ENA indices towards their operationalisation under regional cooperation (in this MS we describe as an example work under OSPAR regional sea convention). The supranational level of work allows to progress work in a coherent manner between EU countries and also to avoid national constraints (e.g. competition between ministries or monitoring cut backs due to financial crisis etc.).

Finally, in future work, it would be interesting to generalize the approach combining ecological research and managers work under the supervision of social sciences as described by de la Vega et al., (2018) (project STopP approach).

Author contributions

GS and NN took the lead in writing the manuscript and developed the paper structure, DG, JJH, NLA and VdeJ added content, AR, DG, IP, JJH, NLA, ST and US added cases. All authors provided critical feedback and helped shape the final manuscript.

Acknowledgments

This work was mainly supported by the EcAprHA project (Addressing gaps in biodiversity indicator development for the OSPAR Region from data to ecosystem assessment: Applying an ecosystem approach to (sub) regional habitat assessments), co-financed by the European Union (EU). Grant No. 11.0661/2015/712630/SUB/ENVC.2

OSPAR. Ulrike Schüchel was supported by the joint research project STOP-Synthese (FKZ03F0745A) funded by the German Federal Ministry of Education and Research (BMBF). Johanna Heymans was funded by the Natural Environment Research Council and Department for Environment, Food and Rural Affairs under the Marine Ecosystems Research Programme (MERP) (grant No. NE/L003279/1). Georges Safi was partly supported by 'France Energies Marines' and the 'Agence Nationale de la Recherche' joint research project TROPHIK (grant No. ANR-10-IEED-0006-12).

References

- Allesina, S., Bondavalli, C., 2003. Steady state of ecosystem flow networks: a comparison between balancing procedures. *Ecol. Model.* 165 (Issues 2–3), 221–229. [https://doi.org/10.1016/S0304-3800\(03\)00075-9](https://doi.org/10.1016/S0304-3800(03)00075-9).
- Arroyo, N.L., Preciado, I., López-López, L., Muñoz, I., Punzón, A., 2017. Trophic mechanisms underlying benthic-demersal community recovery in the north-east Atlantic. *J. Appl. Ecol.* 54, 1957–1967.
- Arroyo, N.L., Safi, G., Vourot, P., López-López, L., Niquil, N., Le Loch, F., Hatab, T., Preciado, I., 2019. Towards coherent GES assessments at sub-regional level: signs of fisheries expansion processes in the Bay of Biscay using an OSPAR food web indicator, the mean trophic level. *ICES J. Mar. Sci.* <https://doi.org/10.1093/icesjms/fsz023> (in press).
- Baird, D., Ulanowicz, R.E., 1989. The seasonal dynamics of the Chesapeake bay ecosystem. *Ecol. Monogr.* 59, 329–364.
- Baird, D., Fath, B.D., Ulanowicz, R.E., Asmus, H., Asmus, R., 2009. On the consequences of aggregation and balancing of networks on system properties derived from ecological network analysis. *Ecol. Model.* 220, 3465–3471.
- Baird, D., Asmus, H., Asmus, R., 2012. Effect of invasive species on the structure and function of the Sylt-Rømø Bight ecosystem, northern Wadden Sea, over three time periods. *Mar. Ecol. Prog. Ser.* 462, 143–162.
- Banasek-Richter, C., Bersier, L.-F., Cattin, M.-F., Baltensperger, R., Gabriel, J.-P., Merz, Y., Ulanowicz, R.E., Tavares, A.F., Williams, D.D., De Ruiter, P.C., Winemiller, K.O., Naisbit, R.E., 2009. Complexity in quantitative food webs. *Ecology* 90, 1470–1477.
- Bentley, J.W., Serpetti, N., et al., 2017. Investigating the potential impacts of ocean warming on the Norwegian and Barents Seas ecosystem using a time-dynamic food-web model. *Ecol. Model.* 360, 94–107.
- Bentley, J.W., Hines, D., Borrett, S., Serpetti, N., Heymans, J.J., 2019. Diet uncertainty analysis strengthens model derived indicators of food web structure and function. *Ecol. Indic.* 98, 239–250.
- Bondavalli, C., Ulanowicz, R.E., Bodini, A., 2000. Insights into the processing of carbon in the South Florida Cypress Wetlands: a whole-ecosystem approach using network analysis. *J. Biogeogr.* 27, 697–710.
- Borja, A., Elliott, E., Carstensen, J., Heiskanen, A.S., van de Bund, W., 2010. Marine management – towards an integrated implementation of the European marine strategy framework and the water framework directive. *Mar. Pollut. Bull.* 60, 2175–2186.
- Borrett, S.R., Lau, M.K., 2014. enaR: an R package for ecosystem network analysis. *Methods Ecol. Evol.* 5 (11), 1206–1213.
- Borrett, S.R., Sheble, L., Moody, J., Anway, E.C., 2018. Bibliometric review of ecological network analysis: 2010–2016. *Ecol. Model.* 382, 62–82.
- Boudreau, P.R., Dickie, L.M., 1992. Biomass spectra of aquatic ecosystems in relation to fisheries yield. *Can. J. Fish. Aquat. Sci.* 49, 1528–1538. <https://doi.org/10.1139/f92-169>.
- Cash, D., Clark, W.C., Alcock, F., Dickson, N.M., Eckley, N., Guston, D., Jäger, J., Mitchell, R., 2003. Knowledge systems for sustainable development. *Proc. Natl. Acad. Sci. U. S. A.* 100, 8086–8091.
- Christensen, V., 1995. Ecosystem maturity - towards quantification. *Ecol. Model.* 77, 3–32.
- Christensen, V., Pauly, D., 1992. E C O P A T H II - a software for balancing steady-state ecosystem models and calculating network characteristics. *Science* (80-.) 61, 169–185.
- Christensen, V., Pauly, D., 1993. Trophic models of aquatic ecosystems. In: *ICLARM Conference Proceedings No. 26*, pp. 390.
- Christensen, V., Walters, C.J., 2004. Ecopath with Ecosim: methods, capabilities and limitations. *Ecol. Model.* 172, 109–139. <https://doi.org/10.1016/j.ecolmodel.2003.09.003>.
- Chrystal, R.A., Scharler, U.M., 2014. Network analysis indices reflect extreme hydro-dynamic conditions in a shallow estuarine lake (Lake St Lucia), South Africa. *Ecol. Indic.* 38, 130–140.
- Coll, M., Palomera, I., Tudela, S., 2009. Decadal changes in a NW Mediterranean Sea food web in relation to fishing exploitation. *Ecol. Model.* 220, 2088–2102. <https://doi.org/10.1016/j.ecolmodel.2009.04.049>.
- Colléter, M., Guitton, J., Gascuel, D., 2013. An introduction to the EcoTroph R Package: analyzing aquatic ecosystem trophic networks. *R J.* 5, 98–107.
- Corrales, X., Coll, M., et al., 2017. Hindcasting the dynamics of an Eastern Mediterranean marine ecosystem under the impact of multiple stressors. *Mar. Ecol. Prog. Ser.* 580, 17–36.
- Curtin, R., Prellezo, R., 2010. Understanding marine ecosystem based management: a literature review. *Mar. Pol.* 34, 821–830.
- Dame, J.K., Christian, R.R., 2007. A statistical test of network analysis: can it detect differences in food web properties? *Ecosystems* 10, 906–923.
- Dimitrios, K.M., Konstantinos, T., Athanassios, M., 2018. Assessing ecological and fisheries implications of the EU landing obligation in Eastern Mediterranean. *J. Sea Res.* 141, 99–111. <https://doi.org/10.1016/j.seares.2018.08.006>.
- Duan, L.J., Li, S.Y., Liu, Y., Moreau, J., Christensen, V., 2009. Modeling changes in the coastal ecosystem of the Pearl river estuary from 1981 to 1998. *Ecol. Model.* 220, 2802–2818. <https://doi.org/10.1016/j.ecolmodel.2009.07.016>.
- EC, 2000. Directive 2000/60/EC of European Parliament and of the Council of 23 October 2000 establishing a framework for community action in the field of water policy. *Off. J. Eur. Comm.* L327/22/12/200:0001e0073.
- EC, 2005a. Thematic Strategy on the Protection and Conservation of the Marine Environment. Communication from the Commission to the Council and European Parliament. European Commission, Brussels 24.10.2005, COM(2005) 504 final.
- EC, 2005b. Framework for Community Action in the Field of Marine Environmental Policy (Marine Strategy Directive). Proposal for a Directive from the European Commission Brussels, 24.10.2005, COM(2005) 505 final.
- EC, 2008. Directive 2008/56/EC of the European parliament and of the Council of 17 June 2008 establishing a framework for community action in the field of marine environmental policy (marine strategy framework directive). *Off. J. Eur. Comm. L* 164, 19e40.
- EC, 2013. European Regulation (EU) No 1380/2013 of the European Parliament and of the Council of 11 December 2013 on the Common Fisheries Policy. amending Council Regulations (EC) No 1954/2003 and (EC) No 1224/2009 and repealing Council Regulations (EC) No 2371/2002 and (EC) No 639/2004 and Council Decision 2004/585/EC.
- EC, 2017. Directive 2017/845/EC of 17 May 2017 amending Directive 2008/56/EC of the European Parliament and of the Council as regards the indicative lists of elements to be taken into account for the preparation of marine strategies. *Off. J. Eur. Comm. L* 125/27.
- Eddy, T.D., Lotze, H.K., Fulton, E.A., Coll, M., Ainsworth, C.H., de Ara ujo, J.N., Bulman, C.M., Bundy, A., Christensen, V., Field, J.C., Gribble, N.A., Hasan, M., Mackinson, S., Townsend, H., 2017. Ecosystem effects of invertebrate fisheries. *Fish Fish.* 18, 40–53. <https://doi.org/10.1111/faf.12165>.
- Elton, C., 1927. *Animal Ecology*. N. Y. Macmillan Co.
- Fagan, W.F., 1997. Omnivory as a stabilizing feature of natural communities. *Am. Nat.* 150, 554–567.
- Fath, B.D., Scharler, U.M., Ulanowicz, R.E., Hannon, B., 2007. Ecological network analysis: network construction. *Ecol. Model.* 208, 49–55. <https://doi.org/10.1016/j.ecolmodel.2007.04.029>.
- Finn, J.T., 1976. Measures of ecosystem structure and function derived from analysis of flows. *J. Theor. Biol.* 56, 363–380. [https://doi.org/10.1016/S0022-5193\(76\)80080-X](https://doi.org/10.1016/S0022-5193(76)80080-X).
- Finn, J.T., 1980. Flow analysis of models of the Hubbard Brook ecosystem. *Ecology* 61, 562–571.
- Finn, J.T., 1983. Cycling index. *Nature* 304, 5925.
- Fung, T., Farnsworth, K.D., Shephard, S., Reid, D.G., Rossberg, A.G., 2013. Why the size structure of marine communities can require decades to recover from fishing. *Mar. Ecol. Prog. Ser.* 484, 155–171. <https://doi.org/10.3354/meps10305>.
- Furukawa, K., 2013. Case studies for urban wetlands restoration and management in Japan. *Ocean Coast. Manag.* 81, 97–102.
- Garces, L.R., Pido, M.D., Tupper, M.H., Silvestre, G.T., 2013. Evaluating the management effectiveness of three marine protected areas in the Calamianes Islands, Palawan Province, Philippines: process, selected results and their implications for planning and management. *Ocean Coast. Manag.* 81, 49–57.
- Gellner, G., McCann, K., 2012. Reconciling the omnivory-stability debate. *Am. Nat.* 179, 22–37.
- Gellner, G., McCann, K., 2016. Consistent role of weak and strong interactions in high- and low-diversity trophic food webs. *Nat. Commun.* 7, 11180. <https://doi.org/10.1038/ncomms11180>.
- Giebels, D., de Jonge, V.N., 2014. Making ecosystem-based management effective: identifying and evaluating empirical approaches to the governance of knowledge. *Emergence* 16 (1), 60–76.
- Giebels, D., van Buuren, A., Edelenbos, J., 2013. Ecosystem-based management in the Wadden Sea: principles for the governance of knowledge. *J. Sea Res.* 82, 176–187.
- Giebels, D., van Buuren, A., Edelenbos, J., 2015. Using knowledge in a complex decision-making process – evidence and principles from the Danish Houting project's ecosystem-based management approach. *Environ. Sci. Policy* 47, 53–67.
- Giebels, D., van Buuren, A., Edelenbos, J., 2016. Knowledge governance for ecosystem-based management: understanding its context-dependency. *Environ. Sci. Policy* 55, 424–435.
- Guesnet, V., Lassalle, G., Chaalali, A., Kearney, K., Saint-Béat, B., Karimi, B., Grami, B., Tecchio, S., Niquil, N., Lobry, J., 2015. Incorporating food-web parameter uncertainty into Ecopath-derived ecological network indicators. *Ecol. Model.* 313, 29–40.
- Hendriksen, A., Jouanneau, C., Koss, R., Raakjaer, J., 2014. Fishing for opinions: stakeholder views on MSFD implementation in European seas. *Mar. Pol.* 50, 353–363.
- Heymans, J.J., Tomczak, M.T., 2016. Regime shifts in the northern Benguela ecosystem: challenges for management, in: *Ecopath 30 years - modelling ecosystem dynamics: beyond boundaries with Ewe*. *Ecol. Model.* 331, 151–159.
- Heymans, J.J., Ulanowicz, R.E., Bondavalli, C., 2002. Network analysis of the south Florida everglades Gramminoid Marshes and comparison with nearby cypress ecosystems. *Ecol. Model.* 149, 5–23.
- Heymans, J.J., Coll, M., Christensen, V., Liralato, S., 2012. Ecopath theory, modelling and application to coastal ecosystems. In: *In: Baird, D., Mehta, A. (Eds.), Treatise on Estuarine and Coastal Science, vol. 9. estuarine and coastal ecosystem modelling*. Elsevier, Oxford, pp. 93–113.
- Heymans, J.J., Coll, M., Liralato, S., Morissette, L., Christensen, V., 2014. Global

- patterns in ecological indicators of marine food webs: a modelling approach. *PLoS One* 9, e95845.
- Heymans, J.J., Skogen, M., Schrum, C., Solidoro, C., 2018. In: Larkin, K.E., Coopman, J., Muniz Piniella, A., Kellett, P., Simon, C., Rundt, C., Viegas, C., Heymans, J.J. (Eds.), *Enhancing Europe's Capability in Marine Ecosystem Modelling for Societal Benefit*. Future Science Brief 4 of the European Marine Board, Ostend, Belgium, pp. 32 ISBN: 9789492043580 ISSN: 2593-5232.
- Hines, D.E., Ray, S., Borrett, R.S., 2018. Uncertainty analyses for Ecological Network Analysis enable stronger inferences. *Environ. Model. Softw* 101, 117–127. <https://doi.org/10.1016/j.envsoft.2017.12.011>.
- Hirata, H., Ulanowicz, R.E., 1984. Information theoretical analysis of ecological networks. *Int. J. Syst. Sci.* 15, 261–270.
- Holling, C.S. (Ed.), 1978. *Adaptive Environmental Assessment and Management*. John Wiley & Sons ISBN 9781932846072.
- Huang, J., Lin, J., Zhang, Y., Li, Q., Hong, H., 2013. Analysis of phosphorus concentration in a subtropical river basin in southeast China: implications for management. *Ocean Coast. Manag.* 81, 29–37.
- Jennings, S., Molen, J. Van Der, 2015. Trophic levels of marine consumers from nitrogen stable isotope analysis: estimation and uncertainty. *ICES J. Mar. Sci.* 72, 2289–2300. <https://doi.org/10.1093/icesjms/fsv120>.
- Jensen, L.F., Søndergård Thomsen, D., Madsen, S.S., Ejbye-Ernst, M., Brandt Poulsen, S., Svendsen, J.C., 2015. Development of salinity tolerance in the endangered anadromous North Sea houting *Coregonus oxyrinchus*: implications for conservation measures. *Endanger. Species Res.* 28, 175–186.
- Jensen, L.F., Rognon, P., Aarestrup, K., Wohlf Böttcher, J., Pertoldi, C., Nøhr Thomsen, S., Hertz, M., Winde, J., Svendsen, J.C., 2017. Evidence of cormorant-induced mortality, disparate migration strategies and repeatable circadian rhythm in the endangered North Sea houting (*Coregonus oxyrinchus*): a telemetry study mapping the post-spawning migration. *Ecol. Freshw. Fish* 1–14.
- de Jonge, V.N., 2003. The need for new paradigms in integrated socio-economic and ecological coastal policy making. In: *Proceedings of 10th International Wadden Sea Symposium*. Ministry of Agriculture, Nature Management and Fisheries, Department North, Groningen, pp. 247–270 272.
- de Jonge, V.N., 2007. Toward the application of ecological concepts in EU coastal water management. *Mar. Pollut. Bull.* 55, 407e414.
- de Jonge, V.N., Schückel U., submitted. Exploring the effects of dredging and organic waste on the quantitative structure and functioning of an estuarine food web by Ecological Network Analysis. *Ocean Coast Manag.* (##: ##-##). <https://doi.org/10.1016/j.ocecoaman.2019.03.013>.
- de Jonge, V.N., Schückel, U., Baird, D., accepted A. Spatial differences in boundary conditions impact carbon flows and ecological network metrics as exemplified for the Ems estuary ecosystem. *Mar. Ecol. Progr. Ser.* ##: ##-##, <https://doi.org/10.3354/meps12825>.
- de Jonge, V.N., Schückel, U., Baird, D., 2019. Subsets of food webs cannot be used as a substitute to assess the functioning of entire ecosystems. *accepted B. Mar. Ecol. Progr. Ser.*
- de Jonge, V.N., Pinto, R., Turner, R.K., 2012. Integrating ecological, economic and social aspects to generate useful management information under the EU Directives 'Ecosystem Approach'. *Ocean Coast Manag.* 68, 169–188.
- Jørgensen, S.E., Patten, B.C., Straškraba, M., 1999. Ecosystems emerging: 3. openness. *Ecol. Model.* 117 (1), 41–64.
- Katsanevakis, et al., 2011. Ecosystem-based marine spatial management: review of concepts, policies, tools and critical issues. *Ocean Coast Manag.* 54, 807–820.
- Kay, J.J., Graham, L.A., Ulanowicz, R.E., 1989. A detailed guide to network analysis. In: Wulf, F. (Ed.), *Network Analysis in Marine Ecology*. Springer-Verlag Berlin Heidelberg 1989.
- Kazanci, C., Ma, Q., 2015. Chapter 3 – system-wide measures in ecological network analysis. In: Park, Y.-S., Lek, S., Baehr, C., Jørgensen, S.E. (Eds.), *Advanced Modelling Techniques Studying Global Changes in Environmental Sciences*. Elsevier, pp. 45–68. <https://doi.org/10.1016/B978-0-444-63536-5.00003-X>.
- Kirkman, H., 2013. Choosing boundaries to marine protected areas and zoning the MPAs for restricted use and management. *Ocean Coast. Manag.* 81, 38–48.
- Kokkoris, G.D., Jansen, V.A.A., Loreau, M., Troumbis, A.Y., 2002. Variability in interaction strength and implications for biodiversity. *J. Anim. Ecol.* 71, 362–371.
- Lassalle, G., Lobry, J., Le Loc'h, F., Bustamante, P., Certain, G., Delmas, D., Dupuy, C., Hily, C., Labry, C., Le Pape, O., Marquis, E., Petitgas, P., Pusineri, C., Ridoux, V., Spitz, J., Niquil, N., 2011. Lower trophic levels and detrital biomass control the Bay of Biscay continental shelf food web: implications for ecosystem management. *Prog. Oceanogr.* 91, 561–575. <https://doi.org/10.1016/j.pocan.2011.09.002>.
- Latham, L.G., Scully, E.P., 2002. Quantifying constraint to assess development in ecological networks. *Ecol. Model.* 154, 25–44.
- Lau, M.K., Borrett, S.R., Singh, P., 2015. *Ecosystem Network Analysis with R: A Guide for Using enaR* 1–45.
- van Leeuwen, J., Raakjaer, J., van Hoof, L., van Tatenhove, J., Long, R., Ounanian, K., 2014. Implementing the Marine Strategy Framework Directive: a policy perspective on regulatory, institutional and stakeholder impediments to effective implementation. *Mar. Pol.* 50 (Part B), 325–330.
- Lester, S.E., McLeod, K.L., Tallis, H., Ruckelshaus, M., Halpern, B.S., Levin, P.S., Chavez, F.P., Pomeroy, C., McCay, B.J., Costello, C., Gaines, S.D., Mace, A.J., Barth, J.A., Fluharty, D.L., Parrish JK, J.K., 2010. Science in support of ecosystem-based management for the US West Coast and beyond. *Biol. Conserv.* 143, 576–587. <https://doi.org/10.1016/j.biocon.2009.11.021>.
- Libralato, S., 2008. System omnivory index. In: *Encyclopedia of Ecology*, pp. 3472–3477. <https://doi.org/10.1016/j.elsep.2009.07.001>.
- Libralato, S., Pranovi, F., Raicevich, S., Da Ponte, F., Giovanardi, O., Pastres, R., Torricelli, P., Mainardi, D., 2004. Ecological stages of the Venice Lagoon analysed using landing time series data. *J. Mar. Syst.* 51, 331–344. <https://doi.org/10.1016/j.jmarsys.2004.05.020>.
- Libralato, S., Coll, M., Tudela, S., Palomera, I., Pranovi, F., 2008. Novel index for quantification of ecosystem effects of fishing as removal of secondary production. *Mar. Ecol. Progr. Ser.* 355, 107–129.
- Lindeman, R.L., 1942. The trophic-dynamic aspect of ecology. *Ecology* 23, 399–417. <https://doi.org/10.1017/CBO9781107415324.004>.
- Lobry, J., David, V., Pasquaud, S., Lepage, M., Sautour, B., Rochard, E., 2008. Diversity and stability of an estuarine trophic network. *Mar. Ecol. Progr. Ser.* 358, 13–25.
- Le Loc'h, F., Hily, C., Grall, J., 2008. Benthic community and food web structure on the continental shelf of the Bay of Biscay (North Eastern Atlantic) revealed by stable isotopes analysis. *J. Mar. Syst.* 72, 17–34. <https://doi.org/10.1016/j.jmarsys.2007.05.011>.
- Ludovisi, A., Scharler, U.M., 2017. Towards a sounder interpretation of entropy-based indicators in ecological network analysis. *Ecol. Indic.* 72, 726–737.
- Luong, A.D., De Laender, F., Olsen, Y., Vadstein, O., Dewulf, J., Janssen, C.R., 2014. Inferring time-variable effects of nutrient enrichment on marine ecosystems using inverse modelling and ecological network analysis. *Sci. Total Environ.* 493, 708–718. <https://doi.org/10.1016/j.scitotenv.2014.06.027>.
- Lynam, C.P., Uusitalo, L., Patrício, J., Piroddi, C., Queirós, A.M., Teixeira, H., Rossberg, A.G., Sagarminaga, Y., Hyder, K., Niquil, N., Möllmann, C., Wilson, C., Chust, G., Galparsoro, I., Forster, R., Verissimo, H., Tedesco, L., Revilla, M., Neville, S., 2016. Uses of innovative modeling tools within the implementation of the marine strategy framework directive. *Front. Mar. Sci.* 3, 182. <https://doi.org/10.3389/fmars.2016.00182>.
- MacArthur, R., 1955. Fluctuations of animal populations and a measure of community stability. *Ecology* 36 (3), 533–536. <https://doi.org/10.2307/1929601>.
- Martinez, N.D., 1991. Artifacts or attributes? Effects of resolution on the little rock lake food web. *Ecol. Monogr.* 61 (4), 367–392.
- McCann, K.S., 2000. The diversity–stability debate. *Nature* 405, 228–233. <https://doi.org/10.1038/35012234>.
- McCann, K.S., Rooney, N., 2009. The more food webs change, the more they stay the same. *Philos. Trans. R. Soc. B* 364, 1789–1801.
- van den Meersche, K., Soetaert, K., Van Oevelen, D., 2009. Xsample(): an R function for sampling linear inverse problems. *J. Stat. Softw., Code Snippets* 30 (1), 1–15.
- Niquil, N., Arias-González, J.E., Delesalle, B., Ulanowicz, R.E., 1999. Characterization of the planktonic food web of Takapoto Atoll lagoon, using network analysis. *Oecologia* 118, 232–241. <https://doi.org/10.1007/s004420050723>.
- Niquil, N., Chaumillon, E., Johnson, G.A., Bertin, X., Grami, B., David, V., Bacher, C., Asmus, H., Baird, D., Asmus, R., 2012. The effect of physical drivers on ecosystem indices derived from ecological network analysis: comparison across estuarine ecosystems. *Estuar. Coast. Shelf Sci.* 108, 132–143. <https://doi.org/10.1016/j.ecss.2011.12.031>.
- Niquil, N., Le Loc'h, F., Tecchio, S., Chaalali, A., Vouriot, P., Mialet, B., Fizzala, X., Féral, J.-P., Lamare, S., Dauvin, J.-C., Safi, G., 2014a. Ongoing research on ecosystem health indicators for food webs in the MSFD context. In: *Trans-Channel Forum Proceedings "Science and Governance of the Channel Marine Ecosystem"*, pp. 14–15.
- Niquil, N., Baeta, A., Marques, J.C., Chaalali, A., Lobry, J., Patrício, J., 2014b. Reaction of an estuarine food web to disturbance: Lindeman's perspective. *Mar. Ecol. Progr. Ser.* 512, 141–154. <https://doi.org/10.3354/meps10885>.
- O'Gorman, E.J., Emmerson, M.C., 2009. Perturbations to trophic interactions and the stability of complex food webs. *Proc. Natl. Acad. Sci. U. S. A.* 106, 13393–13398.
- Oakley, J.W., Lawing, A.M., Guillen, G.J., Gelwicka, F., 2018. Defining ecologically, geographically, and politically coherent boundaries for the Northern Gulf of Mexico coastal region: facilitating ecosystem-based management. *Ocean Coast Manag.* 154, 1–7.
- Odum, E.P., 1969. The strategy of ecosystem development. *Science* 164, 262–270.
- Odum, E.P., 1973. *Fundamentals of Ecology*, third ed. W. B. Saunders, Philadelphia.
- Odum, E.P., 1985. Trends expected in stressed ecosystems. *Bioscience* 35, 419–422.
- Odum, W.E., Heald, E.J., 1975. The detritus-based food web of an estuarine mangrove community. In: Cronin, L.E. (Ed.), *Estuarine Research*. Academic Press, New York, NY, pp. 265–286.
- Pauly, D., Christensen, V., Dalsgaard, J., Froese, R., Torres Jr., F., 1998. Fishing down marine food webs. *JSTOR* 279, 860–863.
- Peng, B., Chen, N., Lin, H., Hong, H., 2013. Empirical appraisal of Jiulong river watershed management program. *Ocean Coast. Manag.* 81, 77–89.
- Pezy, J.P., Raoux, A., Marmin, S., Balay, P., Niquil, N., Dauvin, J.C., 2017. Before-After analysis of the trophic network of an experimental dumping site in the eastern part of the Bay of Seine (english channel). *Mar. Pollut. Bull.* 118, 101–111.
- Pezy, J.P., Raoux, A., Marmin, S., Bailay, P., Niquil, N., Dauvin, J.C., 2018. Short-term response of subtidal soft-bottom community to dredge deposit of spoil estuarine sediment supports the intermediate disturbance hypothesis. *Ecol. Indic.* 91, 232–240.
- Pimm, S.L., 1982. *Food Webs*. Chapman and Hall, London, pp. 219.
- Piroddi, C., Coll, M., Steenbeek, J., Macias Moy, D., Christensen, V., 2015. Modelling the Mediterranean marine ecosystem as a whole: addressing the challenge of complexity. *Mar. Ecol. Progr. Ser.* 533, 47–65.
- Piroddi, C., Moutopoulos, D.K., Gonzalvo, J., Libralato, S., 2016. Using an ecosystem modelling approach to assess the health status of a Mediterranean semi-enclosed embayment (Amvrakikos Gulf, Greece). *Cont. Shelf Res.* 121, 61–73.
- Polovina, J.J., 1984. An overview of the ECOPATH model. *Fishbyte* 2 (2), 5–7.
- Preciado, I., Arroyo, N.L., González-Irusta, J.M., López-López, L., Punzón, A., Muñoz, I., Serrano, A., 2019. Small-scale spatial variations of trawling impact on food web structure. *Ecol. Indic.* 98, 442–452.
- Raoux, A., Tecchio, S., Pezy, J.P., Lassalle, G., Degraer, S., Wilhelmsson, D., Cachera, M., Ernande, B., Le Guen, C., Haraldsson, M., Grangeré, K., Le Loc'h, F., Dauvin, J.C., Niquil, N., 2017. Benthic and fish aggregation inside an offshore wind farm: which

- effects on the trophic web functioning? *Ecol. Indic.* 72, 33–46. <https://doi.org/10.1016/j.ecolind.2016.07.037>.
- Raoux, A., Lassalle, G., Pezy, J.P., Tecchio, S., Safi, G., Ernande, B., Mazé, C., Le Loch, F., Lequesne, J., Girardin, V., Dauvin, J.C., Niquil, N., 2019. Measuring sensitivity of two OSPAR indicators for a coastal food web model under offshore wind farm construction. In Press. *Ecol. Indic.* 96, 728–738.
- Rodriguez, N.J.L., 2017. A comparative analysis of holistic marine management regimes and ecosystem approach in marine spatial planning in developed countries. *Ocean Coast Manag.* 137, 185–197.
- Rogers, K., Roux, D., Biggs, H., 2000. Challenges for catchment management agencies: lessons from bureaucracies, business and resource management. *Water SA* 26 (4), 505–511.
- Rombouts, I., Beaugrand, G., Fizzala, X., Gaill, F., Greenstreet, S.P.R., Lamare, S., Le Loc'h, F., McQuatters-Gollop, A., Mialet, B., Niquil, N., Percelay, J., Renaud, F., Rossberg, A.G., Féral, J.P., 2013. Food web indicators under the marine strategy framework directive: from complexity to simplicity? *Ecol. Indic.* 29, 246–254. <https://doi.org/10.1016/j.ecolind.2012.12.021>.
- Rooney, N., McCann, K.S., 2012. Integrating food web diversity, structure and stability. *Trends Ecol. Evol.* 27, 40–45. <https://doi.org/10.1016/j.tree.2011.09.001>.
- Rossberg, A.G., 2012. A complete analytic theory for structure and dynamics of populations and communities spanning wide ranges in body size. *Adv. Ecol. Res.* 46, 429–522.
- de Ruiter, P.C., Neutel, A.M., Moore, J.C., 1995. Energetics, patterns of interaction strengths, and stability in real ecosystems. *Science* 269 (5228), 1257–1260. <https://doi.org/10.1126/science.269.5228.1257>.
- Rutledge, R.W., Basore, B.L., Mulholland, R.J., 1976. Ecological stability: an information theory viewpoint. *J. Theor. Biol.* 57, 355–371.
- Sain-Béat, B., Baird, D., Asmus, H., Asmus, R., Bacher, C., Pacella, S.R., Johnson, G.A., David, V., Vézina, A.F., Niquil, N., 2015. Trophic networks: how do theories link ecosystem structure and functioning to stability properties? A review. *Ecol. Indic.* 52, 458–471.
- Saint-Béat, B., Dupuy, C., Bocher, P., Chalumeau, J., De Crignis, M., Fontaine, C., Guizien, K., Lavaud, J., Lefebvre, S., Montanié, H., Mouget, J.L., Orvain, F., Pascal, P.Y., Quaintenne, G., Radenac, G., Richard, P., Robin, F., Vézina, A.F., Niquil, N., 2013. Key features of intertidal food webs that support migratory shorebirds. *PLoS One* 8, 1–17. <https://doi.org/10.1371/journal.pone.0076739>.
- Sánchez, F., Olaso, I., 2004. Effects of fisheries on the Cantabrian Sea Shelf ecosystem. *Ecol. Mod.* 172, 151–174.
- Scharler, U.M., Baird, D., 2005. A comparison of selected ecosystem attributes of three South African estuaries with different freshwater inflow regimes, using network analysis. *J. Mar. Syst.* 56, 283–308. <https://doi.org/10.1016/j.jmarsys.2004.09.001>.
- Scharler, U.M., Ulanowicz, R.E., Fogel, M.L., Wooller, M.J., Jacobson-Meyers, M.E., Lovelock, C.E., Feller, I.C., Frischer, M., Lee, R., McKee, K., Romero, I.C., Schmit, J.P., Shearer, C., 2015. Variable nutrient stoichiometry (carbon:nitrogen:phosphorus) across trophic levels determines community and ecosystem properties in an oligotrophic mangrove system. *Oecologia* 179 (3), 863–876. <https://doi.org/10.1007/s00442-015-3379-2>.
- Schückel, U., Kröncke, I., Baird, D., 2015. Linking long-term changes in trophic structure and function of an intertidal macrobenthic system to eutrophication and climate change using ecological network analysis. *Mar. Ecol. Prog. Ser.* 536, 25–38.
- Schückel, U., de Jonge, V., Ludovisi, A., Giebels, D., Horn, S., Niquil, N., Asmus, H., Asmus, R., Eulaers, I., Safi, G., Scharler, U., 2018. Use of Coastal and Estuarine Food Web Models in Policy Making and Management: the Need for an Entire Approach. pp. 26.
- Selleslagh, J., Lobry, J., Amara, R., Brylinski, J.M., Boët, P., 2012. Trophic functioning of coastal ecosystems along an anthropogenic pressure gradient: a French case study with emphasis on a small and low impacted estuary. *Estuar. Coast. Shelf Sci.* 112, 73–85. <https://doi.org/10.1016/j.ecss.2011.08.004>.
- Serpenti, N., Baudron, A.R., et al., 2017. Impact of ocean warming on sustainable fisheries management informs the ecosystem approach to fisheries. *Nat. Sci. Rep.* 7 (13438).
- Soetaert, K., 2009. Package NetIndices, network indices and food web descriptors in R. *Ecology* 1, 1–10.
- Soma, K., Tatenhove, J., Van, Leeuwen, J., Van, 2015. Marine Governance in a European context: regionalization, integration and cooperation for ecosystem-based management. *Ocean Coast. Manag.* 117, 4–13.
- Tallis, H., Levin, P.S., Ruckelshaus, M., Lester, S.E., McLeod, K.L., Fluharty, D.L., Halpern, B.S., 2010. The many faces of ecosystem-based management: making the process work today in real places. *Mar. Pol.* 34, 340–348.
- Tam, J.C., Link, J.S., Rossberg, A.G., Rogers, S.I., Levin, P.S., Rochet, M.-J., Bundy, A., Belgrano, A., Liralato, S., Tomczak, M., van de Wolfshaar, K., Pranovi, F., Gorokhova, E., Large, S.I., Niquil, N., Greenstreet, S.P.R., Druon, J.N., Lesutiene, J., Johansen, M., Preciado, I., Patrício, J., Palialexis, A., Tett, P., Johansen, G.O., Houle, J., Rindorf, A., 2017. Towards ecosystem-based management: identifying operational food-web indicators for marine ecosystems. *ICES J. Mar. Sci.* <https://doi.org/10.1093/icesjms/fsw230>.
- Tecchio, S., Rius, A.T., Dauvin, J.-C., Lobry, J., Lassalle, G., Morin, J., Bacq, N., Cachera, M., Chaalali, A., Villanueva, M.C., Niquil, N., 2015. The mosaic of habitats of the Seine estuary: insights from food-web modelling and network analysis. *Ecol. Model.* 312, 91–101. <https://doi.org/10.1016/j.ecolmodel.2015.05.026>.
- Tecchio, S., Chaalali, A., Raoux, A., Tous Rius, A., Lequesne, J., Girardin, V., Lassalle, G., Cachera, M., Riou, P., Lobry, J., Dauvin, J.C., Niquil, N., 2016. Evaluating ecosystem-level anthropogenic impacts in a stressed transitional environment: the case of the Seine estuary. *Ecol. Indic.* 61, 833–845. <https://doi.org/10.1016/j.ecolind.2015.10.036>.
- Tomczak, M.T., Heymans, J.J., et al., 2013. Ecological network indicators of ecosystem status and change in the Baltic Sea. *PLoS One* 8 (10), e75439.
- Ulanowicz, R.E., 1980. An hypothesis on the development of natural communities. *J. Theor. Biol.* 85, 223–245.
- Ulanowicz, R.E., 1986. Growth and Development. Springer-Verlag, New-York.
- Ulanowicz, R.E., 1992. Ecosystem health and trophic flow networks. In: Costanza, R., Norton, B.G., Haskell, B.D. (Eds.), *Eco-system Health: New Goals for Environmental Management*. Island Press, Washington, DC, pp. 190–225.
- Ulanowicz, R.E., 1997. *Ecology: the Ascendant Perspective*. Columbia University Press, New York, pp. 201.
- Ulanowicz, R.E., 2001. Information theory in ecology. *Comput. Chem.* 25, 393–399.
- Ulanowicz, R.E., 2004. Quantitative methods for ecological network analysis. *Comput. Biol. Chem.* 28, 321–339. <https://doi.org/10.1016/j.compbiolchem.2004.09.001>.
- Ulanowicz, R.E., 2009. Increasing entropy: heat death or perpetual harmonies? *Int. J. Des. Nat. Ecolodyn.* 4 (2), 83–96.
- Ulanowicz, R.E., Kay, J. J., 1991. A package for the analysis of ecosystem flow networks. *Environ. Softw.* 6, 131–142.
- Ulanowicz, R.E., Norden, J.S., 1990. Symmetrical overhead in flow networks. *Int. J. Syst. Sci.* 1, 429–437.
- UNEP, 2011. Taking Steps toward Marine and Coastal Ecosystem-Based Management – an Introductory Guide.
- Utne-Palm, A.C., Salvanes, A.G., Currie, B., Kaartvedt, S., Nilsson, G.E., Braithwaite, V.A., Stecyk, J.A., Hundt, M., van der Bank, M., Flynn, B., Sandvik, G.K., Klevjer, T.A., Sweetman, A.K., Brüchert, V., Pittman, K., Peard, K.R., Lunde, I.G., Strandabø, R.A., Gibbons, M.J., 2010. Trophic structure and community stability in an overfished ecosystem. *Science* 329 (5989), 333–336. <https://doi.org/10.1126/science.1190708>.
- Valls, A., Coll, M., Christensen, V., 2015. Keystone species: toward an operational concept for marine biodiversity conservation. *Ecol. Monogr.* 85 (1), 29–47.
- de la Vega, C., Schückel, U., Horn, S., Kröncke, I., Asmus, R., Asmus, H., 2018. How to include ecological network analysis results in management? A case study of three tidal basins of the Wadden Sea, south-eastern North Sea. *Ocean Coast Manag.* 163, 401–416.
- Velasco, F., Olaso, I., Sanchez, F., 2003. Annual variations in the prey of demersal fish in the Cantabrian Sea and their implications for food web dynamics. In: *ICES Marine Science Symposia*, vol. 219. pp. 408–410.
- Walters, Carl J., 1986. *Adaptive Management of Renewable Resources*. Macmillan ISBN 0029479703.
- Warren, P.H., 1994. In: *Food Webs* 9.
- Waspe, C., Mahabir, R., Scharler, U.M., 2018. FlowCAR: Flow Network Construction and Assessment in R. <https://doi.org/10.5281/zenodo.1408672>.
- Wasson, K., Suarez, B., Akhavan, A., McCarthy, E., Kildow, J., Johnson, K.S., Fountain, M.C., Woolfolk, A., Silberstein, M., Pendleton, L., Feliz, D., 2015. Lessons learned from an ecosystem-based management approach to restoration of a California estuary. *Mar. Pol.* 58, 60–70.
- Wiegert, R.G., Owen, D.F., 1971. Trophic structure, available resources and population density in terrestrial vs. Aquatic ecosystems. *J. Theor. Biol.* 30, 69–81.
- Wulff, F., Field, J.G., Mann, K.H. (Eds.), 1989. *Coastal and Estuarine Studies*, vol. 32. Springer-Verlag, NewYork, pp. 134.