



HAL
open science

Fault tolerant gripper in robotics

Rachid Noureddine, Farid Noureddine, Ali Benamar

► **To cite this version:**

Rachid Noureddine, Farid Noureddine, Ali Benamar. Fault tolerant gripper in robotics. 9th France-Japan, Nov 2012, Paris, France. pp.122-127. hal-02135788

HAL Id: hal-02135788

<https://hal.science/hal-02135788>

Submitted on 21 May 2019

HAL is a multi-disciplinary open access archive for the deposit and dissemination of scientific research documents, whether they are published or not. The documents may come from teaching and research institutions in France or abroad, or from public or private research centers.

L'archive ouverte pluridisciplinaire **HAL**, est destinée au dépôt et à la diffusion de documents scientifiques de niveau recherche, publiés ou non, émanant des établissements d'enseignement et de recherche français ou étrangers, des laboratoires publics ou privés.



Open Archive Toulouse Archive Ouverte (OATAO)

OATAO is an open access repository that collects the work of Toulouse researchers and makes it freely available over the web where possible

This is an author's version published in: <http://oatao.univ-toulouse.fr/22978>

Official URL: <https://doi.org/10.1109/MECATRONICS.2012.6450997>

To cite this version:

Noureddine, Rachid and Noureddine, Farid and Benamar, Ali *Fault tolerant gripper in robotics*. (2013) In: 9th France-Japan, 21 November 2012 - 23 November 2012 (Paris, France).

Any correspondence concerning this service should be sent to the repository administrator: tech-oatao@listes-diff.inp-toulouse.fr

Fault Tolerant Gripper in Robotics

Rachid Noureddine
University of Oran, IMSI
BP 1524 El-M'Naouer
31000 Oran, Algérie
Email:noureddine.rachid@univ-oran.dz

Farid Noureddine
ENIT, LGP
47, Avenue d'Azereix
65016 Tarbes, France
Email:farid.noureddine@enit.fr

Ali Benamar
ENSET, LaRTFM,
BP 1523 El-M'Naouer
31000 Oran, Algérie
Email:ali.benamar@enset-oran.dz

Abstract—The work presented in this article shows, through a case study, the different stages of designing a fault tolerant system; a system which can tolerate faults without losing its operational capability. This system includes a gripper mounted on the wrist of a robot manipulator. First the faults were identified, then the residual generation stage was designed. Analyzing this residual allows us to show that artificially injected faults can be detected and an alarm is generated for an emergency stop command. With regards to the gripper, we have only dealt with the faults we were able to solve thanks to the accommodation stage which must control both hardware and software reconfigurations. The considered faults originated in the electronic interfaces and for an efficient supervision we have designed the whole gripper control. The electronic interfaces concerned by fault occurrence are duplicated to ensure robot task continuity.

Index Terms—Model based fault detection, fault accommodation, electronic redundancy, fault tolerance in robotics.

I. INTRODUCTION

Increasing productivity gains has always been a constant concern in the industry. One of the enhancing solutions is therefore to reduce costs caused by the unavailability of the production tool. This unavailability is often due to the failures of some machines on the production line. Various solutions to enhance the availability of machines, and more generally speaking of systems, can be implemented depending on the industrial field. They also depend on how complex the equipment are and on their nature, as well on how far enhancing solutions can be implemented on equipment that are already designed and in operation. A milestone report is presented in [1] and stresses the needs for reliability and security in industrial processes. Numerous achievements, where the plant maintains safe process operations, are presented in several domains such as power plants, chemical plants, mineral processing, transportation systems, electronic embedded systems and mechatronics.

As regards to enhancing the availability of the systems, it is fundamental to know at what step of the design we can intervene. Numerous degrees of freedom are obviously available in choosing solutions if specifications are taken into account from the design stage of the system. On the contrary if the system is already designed, quite often in operation, and if we want to overcome operating problems detected in the operational phase, the solutions will be much more limited.

As for the design, reliability imperatives impose a rigorous design and the most reliable and available components must

be used. Despite these procedures, faults due to the random nature of operations as well as to the premature wear of some components remain possible. So fault tolerant methods must be implemented and an overview of these methods is presented in the book of [2].

Several steps have to be taken in order to design fault tolerant systems. An essential primary step is the design of fault detection and location. Moreover a diagnosis can be carried out in some cases such as measuring the fault amplitude.

Different approaches can be led to design fault detection and location algorithms and some of these approaches use the analytical model of the considered system. This model is sometimes established as early as the control design phase. So [3] present, for this kind of approach, the basic concepts of fault detection. Most of the developments deal with cases where the systems are linear and time invariant. A more recent study in [4] sums up a quite complete state of the art of the quantitative model-based methods and stresses the advantages and disadvantages of this approach. It uses the analytical model that is well appropriate when the system is modelled by a linear model and when the disturbances can be modelled by an additive term in the state equation. The linear model can be obtained by an identification scheme as in [5]. Errors-in-Variables (EIV) models and the related algorithms were implemented to make the diagnosis of a gas turbine prototype, in this previous work some indices have been used and described in [6] in order to evaluate the efficiency of the fault diagnostic scheme. Another way to proceed in order to use all useful tools in linear systems is to consider different operating points and to deduce from them a multiple linear sub-system. This approach was used in [7] to detect faults in the startup transition of a pH neutralization reactor in a laboratory and in [8], where multi-models are used to design a Fault Detection and Isolation (FDI) scheme applied to a hydraulic system.

In [9] a FDI scheme compatible with distributed control system was suggested for a two-tank system. In this work, Bond graphs are used to model the system, and to obtain the analytical redundancy relations, which are derived from the linear model. In [10] a Linear Matrix Inequality (LMI) based on the filter design methodology for fault detection is suggested, this work is original in so far as it formulates the fault detection problem as a filter-based multi-objective

optimization problem and as it is applied to an aircraft's closed-loop system.

To complete this state of the art for FDI methods, let us quote the methods using qualitative model-based or data-based methods. They are all the more interesting as the analytical model is not available or too complex. Recent works can be found in [11], [12], [13], they review methods based on artificial intelligence and learning control strategies.

In the manufacturing industry, which our paper deals with, the production tool is mainly composed of machine tools, robots, conveyors and these elements are prone to unavoidable faults as well as inadvertent operator errors. In [14] and [15] fault tolerant concepts have been applied in the field of robotics. In the last mentioned paper, the analysis stage shows all the parts of the robot which are concerned by failures. Fault accommodation is considered and based on the kinematic redundancy principle. Calculating the inverse kinematic model of the robot, under some conditions of joint failure, enables the generation of an alternative trajectory to ensure the robot continues to work.

In this article, the system we are working on is composed of a robot gripper attached to the wrist of an industrial robot manipulator. This paper is organized as follows: in section II an analysis of faults that can occur on the gripper mounted on the wrist is presented. The next section treats the fault detection problem on the wrist robot. The last section is dedicated to the designing of a fault tolerant gripper including fault detection and fault accommodation using reconfiguration capabilities. A conclusion ends this article.

II. SYSTEM DESCRIPTION AND FAULT ANALYSIS

The system we are working on is shown in Figure 1. It is composed of a gripper (2 fingers) attached to the wrist of a five rotary joints robot. Only the wrist roll rotation is taken into account.

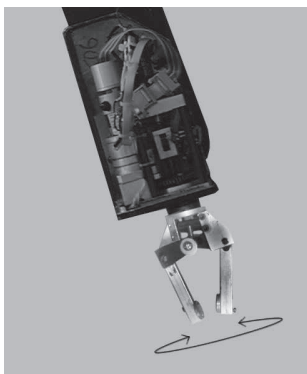

Figure 1. Free rotation of the gripper

In order to

- fully assume the monitoring of all the control processes,
- implement the artificial fault injection and the fault accommodation stage,

we have designed the controller and all the electronic interfaces and associated software.

A. Fault analysis

The failure of the gripper can result in various ways:

- A fault of the drive mechanisms
- A clamping fault on the gripper

To identify fault causes and deduce their consequences, methods of systemic analysis exist. Applying standard approaches such as Failure Mode Effects Analysis (FMEA), Fault Tree Analysis (FTA) are often synonymous with efficiency and rigour. Frequently used in the industry, FMEA is a qualitative method used to identify potential failures of a system or subsystem and then determine the frequency and the impact of the failure. The main objective is to generate a Risk Priority Number (RPN) for each failure mode. The higher the RPN, the more serious the failure. Therefore special attention must be paid to the failure mode. The FMEA technique is explained in [16] and two examples of industrial robots (3 linear joints and 6 rotary joints) are analysed and their RPN are calculated.

Carrying out FMEA requires an initial functional analysis. This functional analysis will depend on the desired degree of precision which will be linked to the size of the selected subsystems. Thus from a very high level, the system we are working on can be decomposed into two subsystems:

- 1) A controller subsystem including a computer, microcontrollers, communication links, electronic boards, power suppliers, ...
- 2) A gripper with joint 5 which can be decomposed, in its turn, into three subsystems:
 - A mechanical subsystem including links, joints, gears, fingers ...
 - Actuator subsystems including motors, brakes, ...
 - Sensors including optical encoders, limit switches...

III. FAULT DETECTION ON THE ROBOT WRIST

The wrist roll rotation is achieved by the fifth joint which is equipped with a DC motor. The angular velocity of the joint is controlled to ensure given performances, its maximum value is 2.2 rad/s . An absolute optical encoder is used to measure the angular position, so the angular velocity is obtained by calculating the derivative. The power amplifier is a fast-switching field effect transistor used in a bridge configuration. A processor board is designed using a microcontroller of the C8051F0000 family, ([17]). An on-board JTAG debug support allows an efficient and quick algorithms development.

To validate our detection algorithms, artificial faults have to be injected into our system. Two types of artificial faults were considered. The first type of fault (f_s) is called sensor fault or measurement fault. The sensor is an absolute optical position encoder. A poor reading of one track of the encoder can lead to an offset on the measured position. The modelling of this fault results in a step signal in the measurement equation of the state modelling. This fault is introduced via a software, modifying the value given by the position encoder.

The second type is often qualified as a dynamic fault (f_d), because it occurs in the state model as a term on the dynamic state equation. Two dynamic faults were considered, the first one, (f_{d1}), concerns the electronic control of the servomotor of joint 5. The second type, (f_{d2}), is a mechanical fault and is implemented by a partial manual locking of joint 5.

A digital controller is implemented and the discrete-time state equations where all variables $\in \mathbb{R}$ are given by:

$$\begin{cases} x_{k+1} = Ax_k + Bu_k + f_{dj_k} \\ y_k = x_k + f_{s_k} \end{cases}, \quad (1)$$

where both dynamic and sensor faults are modelled by an additive term in the state equation. This type of modelling is sufficient when one does not consider the location problem. With a realistic approach, we consider that there can not be 2 or 3 simultaneous faults.

A. Residual generation

Our goal is to provide the decision algorithms with a signal indicating the fault occurrence, known as a residual. Generally speaking the algorithms use can be, depending on the case, just to detect or to detect and locate or else in a complete way to detect, locate and make a diagnosis. Then the decision system must commute the redundant architecture in real time to ensure continued operation.

The model based methods for the detection are widely described in the literature in some surveys given in [18], [19], [20]).

The principle of the chosen method is to estimate the state of the system and then to generate an estimated output which will be subtracted from the real output of the system. When no fault occurs, the difference, which is the residual, should be near zero. The considered system is linear, not very noisy, so a deterministic approach would therefore be appropriate.

The observer is defined by:

$$\begin{cases} \hat{x}_{k+1} = (A - L)\hat{x}_k + Bu_k + Ly_k \\ \hat{y}_k = \hat{x}_k \end{cases}.$$

This observer is such that its error follows the equation $e_{k+1} = \hat{x}_{k+1} - x_k$ and leads to 0 with a dynamics fixed by the choice of $(A - L)$. The error estimation, in our case, may be confused with the residual which we define as: $r_k = e_k$.

The error follows:

$$e_{k+1} = (A - L)e_k + Lf_{s_k} + B(1 - f_{dj_k}).$$

The observer dynamics is chosen to be greater than A , so $(A - L) = 1.25A$. The numerical values corresponding to the system and observer parameters are summarized in Table I.

A	B	L	T	τ_1	α
0.7	0.3	-0.175 ms	25 ms	75 ms	0.7

Table I
SYSTEM AND OBSERVER PARAMETERS

B. Experimental results

We introduced into the system the above mentioned artificial faults described in the section (II-A) and we analysed the residual evolution which is the main decisive element on fault occurrence.

The monitoring of the robot gripper is operated after the velocity has reached its steady-state value.

The results of each experiment are illustrated by three curves showing the evolution of the real velocity of the gripper, the evolution of its estimated velocity and finally the evolution of the residual. The desired velocity varies from $0.5rd/s$ to $1rd/s$. All experiments are shown in Figures 2, 3 and 4.

1) *Injection of sensor fault f_s* : The results are shown in Figure 2. The introduced step, corresponding to the simulated software fault, modifies the measurement of the velocity only at the edges of the signal. At these two moments, the residual becomes significant showing the fault influence. The amplitude of this step is set to $5.24rd/s$ during a period of $1.25s$.

The behaviour of the system faced with a step signal is fully logical because the introduction of the fault is carried out at the level of the position sensor and the velocity is obtained by digital derivation of this position.

The velocity regulation through a position encoder has the advantage of getting rid of the step fault.

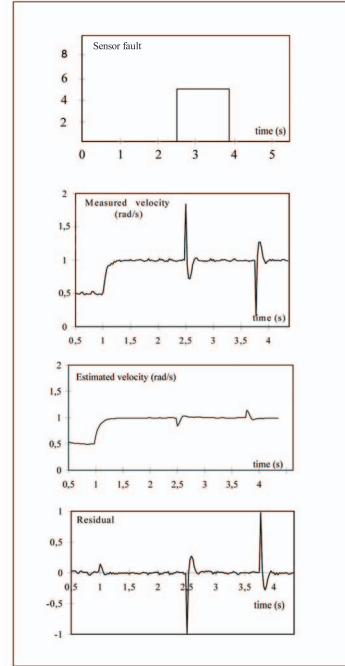

Figure 2. Velocities and residual evolution with sensor fault

2) *Injection of the electronic fault f_{d1}* : This artificial fault caused by a non-destructive short-circuit has a saturation effect on the output of an operational amplifier. The permanent fault is introduced at about $t = 4.25s$ as shown in Figure 3. The gripper reacts consistently because its velocity reaches the maximal reference ($2.2rd/s$). The estimated velocity, which

followed the measured velocity at the time previous to the incipient fault, deviates clearly from it.

The value of the residual proves the occurrence of a fault. Previously to the occurrence of a fault, the residual is virtually zero. At time $t = 1s$, time of the change reference, we note its relatively low value.

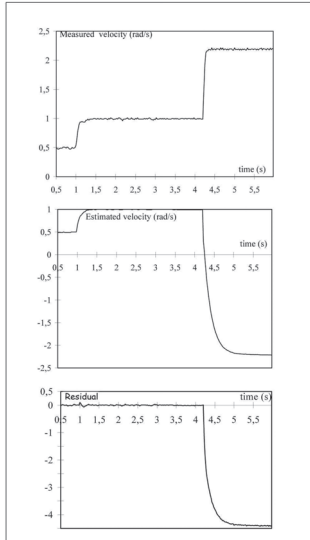

Figure 3. Velocities and residual evolution with electronic fault

3) *Injection of the mechanical fault f_{d2}* : This fault is introduced by a variable manual brake on the gripper. This hard braking displays a high increase in the friction coefficient and thus a modification of the A parameter of (1).

This fault is introduced at about time $t = 3s$, all curves are shown in Figure 4 and from this moment the velocity decreases, then and due to this variable braking, the velocity behaves in a fully uncontrolled way.

The influence of the fault can be seen in the evolution of the estimated velocity as well, the outcoming residual is indicative of the occurrence of a fault and should then be treated.

C. Residual evaluation

When taking only detection into account, a simple way of doing so is to compare the residual with a threshold. The threshold crossing by the residual indicates the occurrence of a fault, this procedure is used in a lot of industrial cases. If we need to identify the fault origin, developments have to be carried out using banks of residuals where each residual refers to only one given fault, [3]. In fact, it all depends on the solutions implemented after the decision step. What solution can be brought to the accommodation problem? In the case when the mechanical structure must be called into question, it hardly seems possible to provide reconfiguration solutions, therefore an emergency stop of the system is activated. This solution is fundamental because it nonetheless allows the stopping of the system and to reduce possible damages and indeed avoid dangerous situations for the operators.

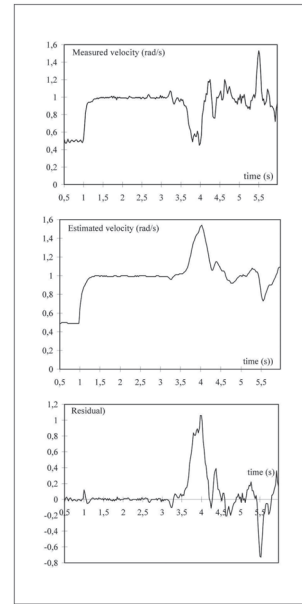

Figure 4. Velocities and residual evolution with mechanical fault

By analyzing the 3 residuals, we are able to see that the setting of a fixed threshold, which takes the noise into account, allows the detection of an occurrence of one of the three faults and so perform an emergency stop. At this point the maintenance team will be in charge of the diagnosis to repair the system.

IV. FAULT TOLERANT GRIPPER

Our work in this part is to design the different stages of a fault tolerant gripper shown in Figure 5, this means the gripper can tolerate faults without losing its operational capability.

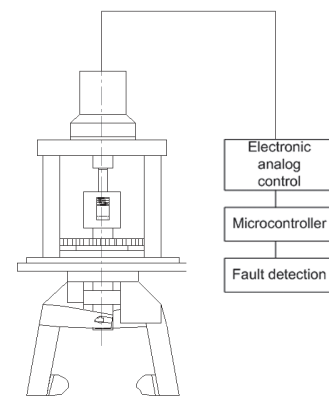

Figure 5. The gripper and its control

We have only dealt with the faults we were able to solve due to the accommodation stage which must control the hardware

and software reconfiguration. The considered faults originate in the electronic interfaces and for an efficient supervision we have designed the whole control of the gripper, software and hardware. The electronic interfaces concerned by the fault occurrence are duplicated to ensure a continued robot task. All the duplicate electronic components are mounted on an electronic board, namely the redundant board. A decision system has to control the switching between the normal and the redundant boards as seen in Figure 6.

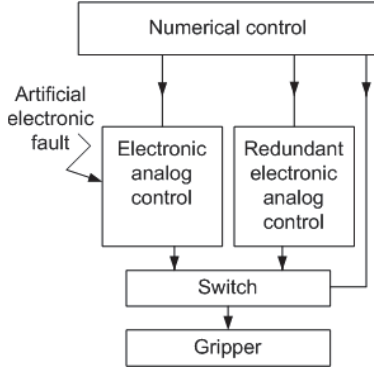

Figure 6. Switching principle

The failure of the gripper can be shown in two different ways:

- either the grasping force is too weak and consequently the object will fall
- or the grasping force is too strong and some objects may be smashed

The fault analysis carried out in section (II-A) on the whole system has enabled us to define the kind of faults which can occur on the system. We are able to bring a concrete reconfiguration solution to the electronic faults. These faults are generated thanks to switches allowing the short-circuit of inputs of some operational amplifier, either to the ground or to the supply voltage. It must be noted that some faults originating in electronic interfaces do not cause the model breakdown, the system remains consistent. For example a short-circuit on an operational amplifier will cause a (high or low) saturation in its output. This saturated signal could be the image of a maximal reference input and thus be interpreted as a normal operation.

A. Motor current control

It is necessary to control the torque developed by the gripper so as to perform manipulations of different forces. The analog control is carried out in adjusting the motor current which puts a pressure force on the gripper through a transmission system. The motor is a DC motor of 15W under a 12V power supply. From an electrical point of view, the motor can be seen as a first order system when the gripper grasps the object. Up to this very point the motor is at rest, the velocity Ω is equal to 0 and thus $K_c\Omega = 0$. The transfer function between the motor current and the desired current is given in the following formula:

$$\frac{i_{mes}}{i_{des}} = \frac{K_1 K_3 K_i + p K_1 K_3 K_p}{L p^2 + (R + K_2 K_3 K_p) p + K_2 K_3 K_i},$$

where:

- K_1 is the gain of the digital-to-analog converter
- K_2 is the gain of the feedback loop
- K_3 is the gain of the power amplifier
- K_p and K_i are the parameters of the controller using a proportional plus integrable law

Γ is the load torque and Γ_s is the dry friction torque. Both are seen as disturbances. The procedure to calculate K_p and K_i is based on the direct design method of Ragazzini, ([21]). From the equation

$$\frac{i_{mes}}{i_{des}} = \frac{K_1 K_3 K_i + p K_1 K_3 K_p}{L p^2 + (R + K_2 K_3 K_p) p + K_2 K_3 K_i} = \frac{k}{1 + \tau_2 p},$$

where k and τ_2 are chosen according to the values of Table II, we obtain $k = \frac{K_2}{K_1}$, $K_i = \frac{1}{K_2 K_3} \left(\frac{-L}{\tau_2} + \frac{R + K_2 K_3 K_p}{\tau_2} \right)$ and $K_p = \frac{1}{K_2 K_3} \left(\frac{L}{\tau_2} \right)$. The numerical values of all parameters are given in Table II.

L	R	τ_2	K_1	K_2	k	K_3	K_p	K_i
13mh	21 Ω	0.5 ms	11	11	1	1.85	1.27	2064

Table II

CURRENT CONTROL PARAMETERS

B. Fault detection and fault accommodation

The generation of the residual is obtained by comparing the desired input with the measured output. It is in fact the error signal of the control loop expressed as:

$$r(t) = i_{des} - i_{mes} \quad (2)$$

The fault is monitored under steady-state conditions and in a duration long enough so that there cannot be any confusion with the activity of the regulator resulting from the treatment of any disturbance. In these operating conditions, the use of a fixed threshold is suitably appropriate as expressed in [5].

This simple residual evaluation is achieved by comparing $r(t)$ with a fixed threshold λ as follows:

$$\begin{cases} r(t) \leq \lambda, & \text{no fault} \\ r(t) > \lambda, & \text{fault occurs} \end{cases}$$

The threshold level was defined by experiments. If the residual $r(t)$ exceeds the threshold, a fault will have occurred and a signal generated to switch to the redundant board, see Figure 7. Discussions about the use of comparators with different threshold voltages are given in [22] where a method of fault diagnosis of analog parts of electronic embedded systems is presented.

The reconfiguration problems are that much easier to solve as we have designed all the electronic control boards as well

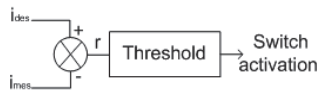

Figure 7. Switch control

as the redundant board identical to the normal board. Both cards are gathered on a single board. This board is connected to the C8051 F0005DK development kit and all programs are written in C language.

V. CONCLUSION

As for the wrist, using the model based method and more precisely the observer design we have shown that all artificial injected faults were detected. This technique of fault detection is appropriate because the model is already implemented due to the velocity control design. Thanks to several residuals, we were able to distinguish between electronic and mechanical faults.

With regards to the gripper, we have only dealt with the faults we were able to solve at the accommodation stage. The considered faults originate in the electronic interfaces and for an efficient supervision we designed the whole control of the gripper. Though this work required a great deal of engineering investment during two years, that is the contribution of students (internships) and the technician involvement, it also brought to the fore the close link that is absolutely necessary between normal mode design and all reconfiguration problems.

REFERENCES

- [1] Mc Avoy, T., Jämsä-Jounela, S. L., Patton, R. J., Perrier, M., Weber, H. and Georgakis C. (2004). Milestone report for area 7 industrial applications. *Control Engineering Practice*, 12, 113-119.
- [2] Blanke, M., Kinnaert, M., Lunze, J. and Staroswiecki, M. (2003). *Diagnosis and fault-tolerant control*. Springer.
- [3] Chen, J. and Patton, R. J. (1999). *Robust model-based fault diagnosis for dynamic systems*. Kluwer Academic Publishers.
- [4] Venkatasubramanian, V., Rengaswamy, R., Yin, K. and Kavury, S. N. (2003). A review of process fault detection and diagnosis. Part I: Quantitative model-based methods *Computers and Chemical Engineering*, 27, 293-311.
- [5] Simani, S. and Patton, R. J. (2008). Fault diagnosis of an industrial gas turbine prototype using a system identification approach. *Control Engineering Practice*, 16, 769-786.
- [6] Bartys, M., Patton, R., Syfert, M., De las Heras, S. and Quevedo, J. (2006). Introduction to the DAMADICS actuator FDI benchmark study. *Control Engineering Practice*, 14, 577-596.
- [7] Bhagwat, A., Srinivasan, R. and Krishnaswamy, P. R. (2003). Multilinear model-based fault detection during process transitions. *Chemical Engineering Sciences*, 58, 1649-1670.
- [8] Rodrigues, M., Theilliol, D., Adam-Medina, M. and Sauter, D. (2008). A fault detection and isolation scheme for industrial systems based on multiple operating models. *Control Engineering Practice*, 16, 225-239.
- [9] Samantaray, A. K., Ghostal, S. K. and Chakraborty, S. (2007). Bond graph model based design of supervision algorithm for distributed fault tolerant control systems. *International Journal of Automation and Control*, 1, 1, 28-47.
- [10] Zhou, J. and Huang, X. (2008). Application of a new fault detection approach to aircraft's closed-loop control system. *ICIRA, Part II*, Springer-Verlag, 1223-1232.
- [11] Kettunen, M., Zhang, P. and Jämsä-Jounela, S. L. (2008). An embedded fault detection, isolation and accommodation system in a model predictive controller for an industrial benchmark process. *Computers and Chemical Engineering*, 32, 2966-2985.
- [12] Marcu, T., Köppen-Seliger, B. Stücher, R. (2008). Design of fault detection for a hydraulic looper using dynamic neural networks. *Control Engineering Practice*, 16, 192-213.
- [13] Zaki, O., Brown, K., Fletcher, J. and Lane, D. (2007). Detecting faults in heterogeneous and dynamic systems using DSP and agent-based architecture. *Engineering Applications of Artificial Intelligence*, 20, 1112-1124.
- [14] Filaretov, V.F., Vukobratovic, M.K. and Zhibabob, A.N. (2008). Parity relation approach to fault diagnosis in manipulation robots. *Mechatronics*, 12(8), 999-1010.
- [15] Nouredine, F., Larroque, B. and Rotella, F. (2009). Fault tolerance in robotics. *International Journal of Mechatronics and Manufacturing Systems*, vol.2, N°3, 2009.
- [16] Korayem, M. and Iravani, A. (2008). Improvement of 3p and 6r mechanical robots reliability and quality applying FMEA and QFD approaches. *Robotics and Computer-Integrated Manufacturing*, 24, 472-487.
- [17] Silicon Labs, <https://www.silabs.com>. Mixed-Signal 32 KB ISP Flash MCU Family.
- [18] Patton, R.J. and Chen, J. (1997). Observer-based fault detection and isolation: robustness and applications. *Control Engineering Practice*, 5(5), 671-682.
- [19] Isermann (1997). Supervision, fault detection and fault-diagnosis methods-An introduction. *Control Engineering Practice*, 5(5), 639-652.
- [20] Garcia, E.A. and Franck, P.M. (1997). Deterministic non linear observer-based approaches to fault diagnosis : A survey. *Control Engineering Practice*, 5(5), 663-670.
- [21] Frankl brought to the fore, G. F., Powel, J. D. and Workman, M. L. (1990). *Digital Control of Dynamic Systems*. Second Edition, Addison-Wesley.
- [22] Czaja (2009). A method of fault diagnosis of analog parts of electronic embedded systems with tolerances. *Measurement* 42, 903-915