



HAL
open science

Supercritical carbon dioxide extraction and fractionation of lipids from freeze-dried microalgae *Nannochloropsis oculata* and *Chlorella vulgaris*

Sara Obeid, Nicolas Beaufiles, Séverine Camy, Hosni Takache, Ali Ismail,
Pierre-Yves Pontalier

► To cite this version:

Sara Obeid, Nicolas Beaufiles, Séverine Camy, Hosni Takache, Ali Ismail, et al.. Supercritical carbon dioxide extraction and fractionation of lipids from freeze-dried microalgae *Nannochloropsis oculata* and *Chlorella vulgaris*. *Algal Research - Biomass, Biofuels and Bioproducts*, 2018, 34, pp.49-56. 10.1016/j.algal.2018.07.003 . hal-02135624

HAL Id: hal-02135624

<https://hal.science/hal-02135624v1>

Submitted on 21 May 2019

HAL is a multi-disciplinary open access archive for the deposit and dissemination of scientific research documents, whether they are published or not. The documents may come from teaching and research institutions in France or abroad, or from public or private research centers.

L'archive ouverte pluridisciplinaire **HAL**, est destinée au dépôt et à la diffusion de documents scientifiques de niveau recherche, publiés ou non, émanant des établissements d'enseignement et de recherche français ou étrangers, des laboratoires publics ou privés.



Open Archive Toulouse Archive Ouverte (OATAO)

OATAO is an open access repository that collects the work of some Toulouse researchers and makes it freely available over the web where possible.

This is an author's version published in: <http://oatao.univ-toulouse.fr/21082>

Official URL: <https://doi.org/10.1016/j.algal.2018.07.003>

To cite this version:

Obeid, Sara and Beaufils, Nicolas and Camy, Séverine and Takache, Hosni and Ismail, Ali and Pontalier, Pierre-Yves Supercritical carbon dioxide extraction and fractionation of lipids from freeze-dried microalgae *Nannochloropsis oculata* and *Chlorella vulgaris*. (2018) *Algal Research*, 34. 49-56. ISSN 2211-9264

Any correspondence concerning this service should be sent to the repository administrator:

tech-oatao@listes-diff.inp-toulouse.fr

Supercritical carbon dioxide extraction and fractionation of lipids from freeze-dried microalgae *Nannochloropsis oculata* and *Chlorella vulgaris*

Sara Obeid^{a,b,c,*}, Nicholas Beaufile^a, Séverine Camy^d, Hosni Takache^{b,c}, Ali Ismail^{b,c}, Pierre-Yves Pontalier^a

^a Laboratoire de Chimie Agro-industrielle (LCA), Université de Toulouse, INRA, INPT, 4 allée Emile Monso, 31030 Toulouse cedex 4, France

^b Département des Sciences et Technologies Alimentaires, Faculté des Sciences Agronomiques, Université Libanaise, Dekwaneh, Lebanon

^c Plateforme de Recherches et d'Analyses en Sciences de l'Environnement (PRASE), Ecole Doctorale des Sciences et Technologies, Université Libanaise, Hadath, Lebanon

^d Laboratoire de Génie Chimique (LGC), INP-ENSIACET, Université de Toulouse, 31030 Toulouse, France

ABSTRACT

Keywords:

Supercritical carbon dioxide extraction

Solid phase extraction

Neutral lipids

Chlorella vulgaris

Nannochloropsis oculata

This study deals with the selective extraction of neutral lipids from microalgae. We investigated the consequences of bypassing cell-wall disintegration before supercritical carbon dioxide extraction. Different operating parameters (use of co-solvent, pressure, and time) were tested on freeze-dried *Chlorella vulgaris* and *Nannochloropsis oculata*. The solid phase extraction technique (SPE) was used throughout the extraction process to assess variations in the yield of liberated neutral lipids, glycolipids, and phospholipids. Under operating conditions, 97% of neutral lipids were extracted from *C. vulgaris* using ethanol (10% v/v) as co-solvent. Neutral lipids from *N. oculata* represented most of the extracts (83%), whereas the proportion of glycolipids and phospholipids did not exceed 12.1% and 5.3%, respectively. Microscopic observation showed that cell wall integrity was maintained during the extraction process.

1. Introduction

Microalgal Lipids can generally be divided into two large classes based on the polarity of the molecular head group: polar and neutral lipids. Polar lipids can be categorized into phospholipids (PPL) and glycolipids (GL). They are essential structural components of cell membranes and organelle membranes that contribute to their flexibility, fluidity and selective permeability. Neutral lipids (NL) consist of acylglycerols and free fatty acids and are used for energy storage [1]. They are present as droplets in the chloroplast matrix and in the cytoplasm. Their extraction from the cellular matrix into the surrounding medium can be diminished by the rigidity of cell wall. Indeed, the microalgal lipids recovery involves several steps including cultivation, harvesting, drying and lipid extraction [2] [3]. Based on life cycle assessment studies, the oil extraction process consumes 90% of the energy, which signifies a need to improve the economic viability of the process [4].

Lipid extraction from microalgae is generally carried out using organic solvent. This is because chemical solvent has high selectivity and solubility towards lipids. However, such processes, which give rise to

high lipids yields, cannot be used at industrial scale due to the high toxicity of organic solvents on human and environment [5].

In extraction using chemical solvent, diffusion is always the limiting factor in the overall mechanism [6]. However, this factor becomes more critical in microalgae as the cell wall may prohibit solvent from diffusing into the inner cell for lipid extraction. Therefore, mechanical pretreatments are generally introduced to enhance solvent diffusion efficiency and consequently, to improve microalgal lipid recovery rate. However, the methods used are nonselective and generally accompanied by cell wall destruction, leading to complex extracts of hydrophilic and hydrophobic components. Such treatments require additional costly stages in downstream processing for phase separation and compound purification. For example the presence of phospholipids in lipid extracts implies an additional degumming step to remove them either for food, health and energy applications [3].

Supercritical carbon dioxide (ScCO₂) extraction of microalgal lipids has received attention as an alternative to organic solvent extraction and has been shown to be an ideal method for extracting certain lipids [7]. Several studies reported high extraction yield using ScCO₂ [8] [9] [10]. However, from these works, it appears that the microalgae

Abbreviations: SPE, solid phase extraction; PPL, phospholipids; GL, glycolipids; NL, neutral lipids; ScCO₂, supercritical carbon dioxide

* Corresponding author at: Laboratoire de Chimie Agro-industrielle (LCA), Université de Toulouse, INRA, INPT, 4 allée Emile Monso, 31030 Toulouse cedex 4, France.

E-mail addresses: saraobeid.university.leb@live.com (S. Obeid), Pontalier@ensiacet.fr (P.-Y. Pontalier).

<https://doi.org/10.1016/j.algal.2018.07.003>

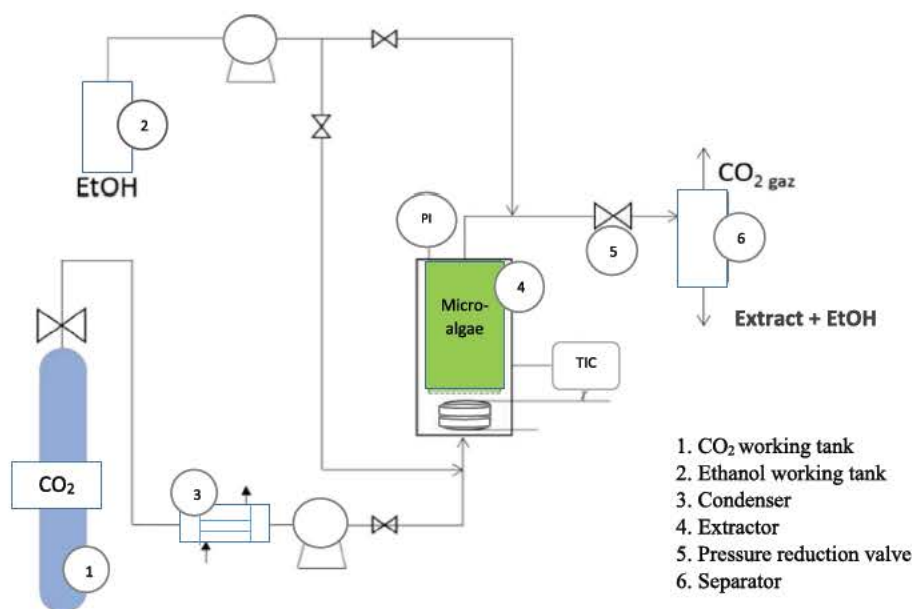

Fig. 1. Description of the supercritical carbon dioxide pilot.

pretreatment is highly significant to perform an efficient extraction with ScCO₂. In major cases, prior to supercritical extraction, mechanical pretreatment was carried out and high amount of organic co solvent was used for increasing lipid extraction yield all in sharply decreasing selective NL extraction. Patil et al. [9] subjected *Nannochloropsis* biomass to microwave pretreatment prior to supercritical extraction and added an azeotropic mixture (hexane/ethanol) as co solvent to enhance ScCO₂ affinity towards NL, giving a low selective extraction. Increasing the co extraction of polar lipids necessitates therefore further purification steps. Cheng et al. [10] studied NL extraction from freeze dried *Pavlova* sp. subjected to cell disruption prior to extraction. The highest extraction yield of 98.7% was observed using ScCO₂ with bead beating as pretreatment. However, low selectivity of lipid extraction was obtained due to cell disintegration and as result, further purification steps were necessary. Recently, Crampon et al. [11] reported the use of ScCO₂ at industrial scale for the extraction of NL from *Spirulina platensis* without cell disruption. However *S. platensis* is known to have a vulnerable cell wall and did not require a severe cell disruption contrary to lipid rich microalgae having a robust cell wall like *C. vulgaris* and *N. oculata* [12].

The aim of this study was to investigate the extraction of NL from *C. vulgaris* and *N. oculata* using ScCO₂ without cell disruption. On the one hand, we study the effect of ScCO₂ key parameters on the extraction yield: temperature, pressure and addition of polar modifier (ethanol 10% v/v). Such addition of polar modifier allows to understand the effect of polar lipid co extraction on NL extraction yield. On the second hand, the selectivity of NL extraction was evaluated by analyzing the composition of microalgal lipid extracts all long the process using solid phase extraction (SPE) technique. To our knowledge, similar study has never been discussed in the literature.

2. Materials and methods

2.1. Microalgae biomass

C. vulgaris and *N. oculata* used in this study were provided freeze dried by Alpha Biotech (Ass rac, France). These two species were used because they possess an extra rigid membrane, due to their growth under stressful conditions [12]. *N. oculata* was cultivated in modified Conway media under conditions of N nutrient deficiency to favor the accumulation of lipids, whereas the microalga *C. vulgaris* was cultivated in Sueoka media under conditions of high N nutrient concentration to

favor protein accumulation. Biomass have been harvested during the exponential growth phase and concentrated by centrifugation (20–24% dry weight). The frozen paste of crude microalgae was freeze dried in a Fisher Bioblock Scientific Alpha 2 4 LD Plus device (Illkirch, France). During freeze drying, the pressure was reduced to 0.01 bar, and the temperature decreased to -80°C for 48 h to give a completely dry biomass. After freeze drying process, freeze dried aggregates were slightly spread with a laboratory spatula. The mean diameter of particles was measured using Mastersizer 2000 granulometer (Malvern Instruments Ltd.) showing a value around 200 μm .

2.2. Total lipids content

The term “total lipids” represents the amount of all extractable lipids initially present in the algal biomass. This amount served as a reference throughout the study to evaluate the effectiveness of lipid extraction using ScCO₂. Total extractable lipids were measured after extraction in a Soxhlet apparatus using a slightly modified method based on the two methods developed by Blight and Dyer (1959) and Folch (1957), using a mixture of polar and non polar solvents: chloroform/methanol (0.35/0.65, V/V) [13] [14] [15]. The microalgal biomass (3 g) was placed in a cartridge filter paper in 200 mL solvent. The Soxhlet extractor was operated for multiple cycles for 18 h to ensure the extraction of all extractable lipids.

2.3. ScCO₂ extraction

Extraction was carried out using a pilot unit developed by the company Separex (Nancy, France). The pilot was composed of a 25 cm³ autoclave (Fig. 1). This unit could be operated at pressures up to 1000 bar and a temperature up to 250 $^{\circ}\text{C}$. At the beginning of the experiment, the extractor was filled with determined mass of freeze dried microalgae powder (Table 1) and the module was supplied with liquid CO₂ through a pump which was maintained at a temperature below 7 $^{\circ}\text{C}$ to keep the CO₂ in the liquid state. Ethanol was introduced into the extractor either as a co solvent or a cleaning fluid.

Several extractions were performed by varying the working pressure and solvent polarity (addition of ethanol 10% v/v). All supercritical extractions were carried out under constant temperature of 50 $^{\circ}\text{C}$. A simple extraction consisted of one step of ScCO₂ extraction with or without ethanol as co solvent (10% v/v), whereas a double extraction

Table 1

Operating conditions for ScCO₂ extraction applied to freeze-dried *C. vulgaris* and *N. oculata*, with and without ethanol (10%) as co-solvent.

Microalgae	T (°C)	P (bar)	CO ₂ flow rate (g/min)	CO ₂ (g/min)	Biomass (g)	Solvent rate (g/g·min ⁻¹)	Ethanol as co-solvent	Ethanol flow rate (g/min)	Operation time (min)
Simple extraction									
<i>C. vulgaris</i>	50	250	25		12.1	0.45	Yes	1.9	230
<i>N. oculata</i>	50	250	25		25.4	1.02	No	–	210
<i>N. oculata</i>	50	450	25		8.8	0.35	No	–	240
<i>N. oculata</i>	50	750	25		8.8	0.35	No	–	240
Double extraction									
<i>C. vulgaris</i>	50	250	25		25.4	1.02	No	–	210
Residue	50	250	25		23.4	0.87	Yes	1.9	210

Note: Simple extraction: ScCO₂ extraction with 10% ethanol as co-solvent. Double extraction: ScCO₂ extraction with addition of ethanol at t = 210 min. Solvent rate is the ratio of incorporated biomass (g) with respect to the CO₂ flow rate (g/min), as the extraction is semi-continuous.

C. vulgaris: *Chlorella vulgaris*, *N. oculata*: *Nannochloropsis oculata*, T: temperature, P: pressure, CO₂: carbon dioxide, ScCO₂: supercritical carbon dioxide.

consisted of first performing ScCO₂ extraction followed by a second ScCO₂ extraction with co solvent (Table 1).

2.4. Fractionation of neutral and polar lipids

All lipids extracted from *N. oculata* and *C. vulgaris*, either by ScCO₂ or Soxhlet, were fractionated into neutral and polar lipids using the solid phase extraction method (SPE) described by Juaneda and Rocquelin [16]. The cartridges were conditioned by slowly adding 5 mL chloroform followed by 5 mL methanol, reaching the top of the gel to ensure good rinsing. A sample of 25 mg lipids was applied to the top of the silica cartridges Supelco (500 mg, Sigma Aldrich). The NL fraction was eluted with 10 mL chloroform, whereas the GL and PPL fractions were eluted with 10 mL acetone and methanol, respectively. Once eluted and freeze dried under liquid nitrogen, every fraction was measured gravimetrically. The contents of neutral and polar lipids are expressed in g/g dry biomass.

2.5. Microscopic observation

Microscopically qualitative approach was done to characterize any cell disintegration of the biomass. Observation at high magnifications (×1000) was performed before and directly after ScCO₂ treatments. A small quantity of cell suspension was placed on a specific plate (Nikon SMZ 1500). The images were captured under a constant exposure and illumination by Nikon eclipse E600 camera.

2.6. Statistical analysis

Results for microalgae characterization in terms of lipid content were based on 3 replicates for 3 experiments (n = 9). All supercritical extraction data were presented as mean values ± standard deviations of three experiments. Statistically significant differences (p < 0.05) between the means were evaluated using one way analysis of variance (ANOVA) and the Tukey's test on XLSTAT software version 2018.1.

3. Results and discussion

3.1. Microalgae characterization

The lipids composition of the studied microalgae was defined according to the values following Soxhlet extraction [17]. The maximal lipids extraction yield was obtained after 18 h: 0.399 ± 0.016 and 0.244 ± 0.010 g/g dry weigh for *N. oculata* and *C. vulgaris*, respectively (Table 2).

The proportions of various lipids classes were evaluated by SPE fractionation. *N. oculata* was rich in NL, comprising 44.0 ± 1.6% of its total lipids content. The high lipids content of *N. oculata* may be explained by the growth conditions. In fact, the studied strain was grown under conditions of normal CO₂ concentration and nitrogen depletion.

Cultivation under such conditions can induce lipids accumulation which surpasses that during normal growth conditions, as well as favoring the production of mostly NL [18].

In contrast to *N. oculata*, *C. vulgaris* was grown under conditions of high N nutrient levels. Microalgae grown under such conditions have polar lipids as predominant lipids, which are located in chloroplasts and cell membranes [19].

C. vulgaris had a lower NL content (26.0 ± 0.4% of its total lipids) than *N. oculata*. This suggests that *C. vulgaris* did not accumulate large amounts of reserve lipids due to the growth conditions. Hence, most of the available lipids were polar, especially GL, which represented 59.0 ± 0.8% of the total lipid content. Our results concerning the lipids composition of *N. oculata* and *C. vulgaris* are in accordance with several studies in the literature [20] [21] [22]. These results were used as reference values throughout this study.

3.2. Supercritical extraction yield and kinetics

3.2.1. Effect of pressure on lipids extraction from *N. oculata*

Fig. 2 shows the effect of pressure on the extraction yield of microalgal lipids from freeze dried *N. oculata* by ScCO₂. Extraction at 250 bar resulted in a very low yield (15%). Increasing the pressure to 450 and 750 bar led to an increase of the extraction yield (20%). Several studies reported that the extraction efficiency of ScCO₂ increases with pressure [23] [24]. In fact, increasing the pressure results in an increase in the solubility of NL in ScCO₂. Moreover, the adsorption capacity of solute decreases at high pressure [25] [26]. At least, part of the lipids droplets bounded to the cell matrix may desorb during extraction at high pressure.

Microscopic observation of *N. oculata* subjected to ScCO₂ treatment showed maintained cell wall integrity (Fig. 3). The presence of such structure could limit the mass transfer of the solvent and then the extraction of NL which may explain the low extraction yield obtained for all pressures.

3.2.2. Effect of medium polarity on lipid extraction from *C. vulgaris*

The solubility of lipids in ScCO₂ or ethanol depends on their chemical composition. Studied *C. vulgaris* strain was grown under high N nutrient growth conditions. It was thus expected to have a low lipids content, mainly composed of polar lipids (GL and PPL) as shown in Table 2.

Given the relatively high polarity of the initial lipids fraction, we tested the addition of ethanol as co solvent to enhance its solubilization/extraction (Fig. 4). The addition of ethanol (10% v/v) at the beginning of the process markedly enhanced the extraction kinetics during the first 100 min relative to the first stage (absence of ethanol) of the double extraction procedure. In the presence of co solvent, the final yield reached almost 40.3 ± 1.1% of the total extract (Fig. 4A).

The extraction of lipids was likely controlled initially by their solubility in ScCO₂/ethanol and then, after the break of the curve, it was

Table 2

Lipids fractions (NL, GL, PPL) relative to total lipids and dry matter in *C. vulgaris* and *N. oculata*. Results are based on 3 replicates for 3 experiments \pm SD (n = 9).

	<i>C. vulgaris</i>			<i>N. oculata</i>		
Total lipids (g/g DM)	0.244 \pm 0.010			0.399 \pm 0.016		
Fraction in total lipids (%)	NL	GL	PPL	NL	GL	PPL
	26.0 \pm 0.4	59.0 \pm 0.8	15.0 \pm 0.6	44.0 \pm 1.6	30.1 \pm 0.8	25.9 \pm 0.9

Note: *C. vulgaris*: *Chlorella vulgaris*, *N. oculata*: *Nannochloropsis oculata*, NL: neutral lipids, GL: glycolipids, PPL: phospholipids.

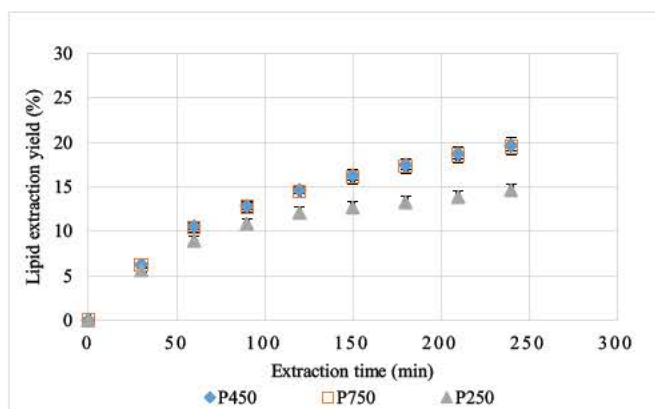

Fig. 2. Lipid extraction yield (extracted/total extractable) from *Nannochloropsis oculata* over time using supercritical CO₂ (ScCO₂) extraction under different applied pressures (P): 250, 450, or 750 bar. Data shown as mean \pm SD (n = 3).

probably related to lipids desorption from the cell matrix [27]. The non-extracted lipids remain adsorbed on the microalgal matrix and the equilibrium phase are described by the adsorption isotherm. The adsorption capacity can be estimated from the point at which the slope of the extraction curve suddenly decreases.

Lipids extraction from *C. vulgaris* using ScCO₂ without ethanol showed stabilization of the extraction yield at almost 12.5 \pm 0.6% after 120 min (Fig. 4B). Ethanol (10% v/v) addition after 210 min increased the yield. The addition of ethanol modified the solvent (CO₂) properties, shown by the increased slope for the linear portion of the curve. Changing solvent polarity allowed further extraction of molecules that were not accessible to the ScCO₂. Indeed, combining ethanol (a polar solvent) with CO₂ has been shown to improve the extraction of

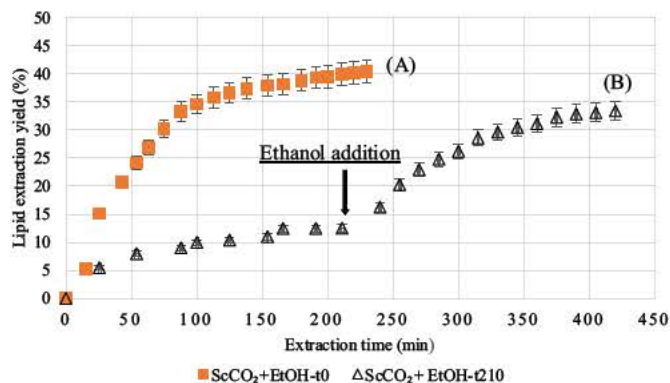

Fig. 4. Lipid extraction yield (extracted lipids/total extractable lipids) from *Chlorella vulgaris* over time under P = 250 bar. (A) Simple supercritical CO₂ (ScCO₂) extraction with ethanol (10% v/v) as co-solvent, (B) double extraction: ScCO₂ extraction with addition of ethanol at t = 210 min. Data shown as mean \pm SD (n = 3).

various lipids classes (neutral, polar) as reported in the literature [28]. Microscopic observation showed that *C. vulgaris* microalgae preserve its cell wall integrity after ScCO₂ treatment (Fig. 5).

3.3. Extracts composition

3.3.1. *N. oculata* extracts composition

Lipids extraction from *N. oculata* by ScCO₂ under 450 and 750 bar, resulted in comparable quantities of extracted lipids of similar quality. Under 450 bar, NL represented 70.0 \pm 1.3% of the extracts at the beginning and 80 \pm 2% by the end of the extraction (Fig. 6A). The fraction of PPL did not exceed 7.1 \pm 0.3% throughout the analysis, while GL made up 26.0 \pm 1.1% of the extracts at the beginning and

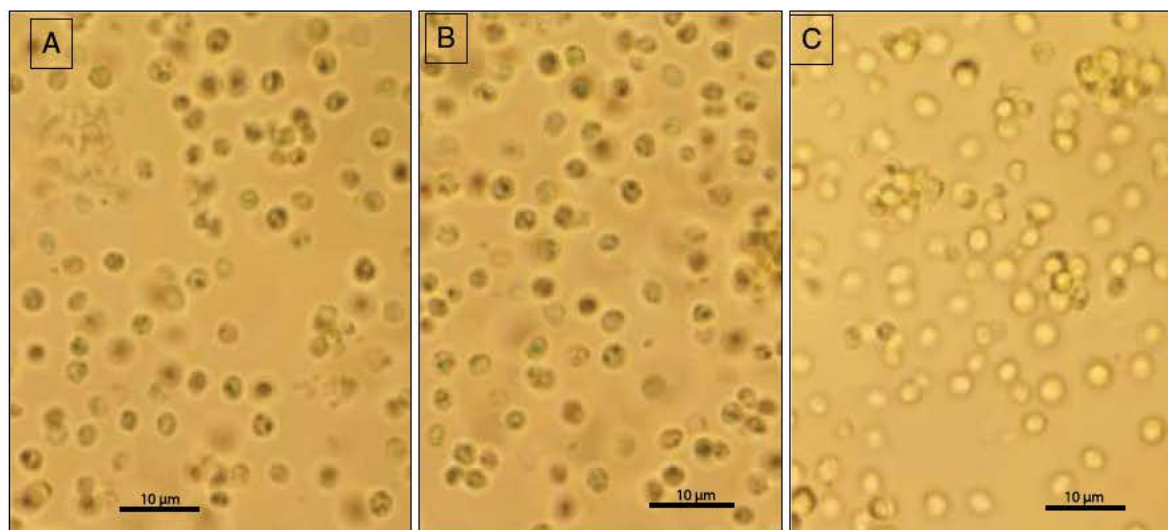

Fig. 3. Microscopic observation at high magnification (\times 1000) of *Nannochloropsis oculata* cells after supercritical CO₂ (ScCO₂) extraction. (A) Control before extraction, (B) After extraction under 450 bar, (C) After extraction under 750 bar.

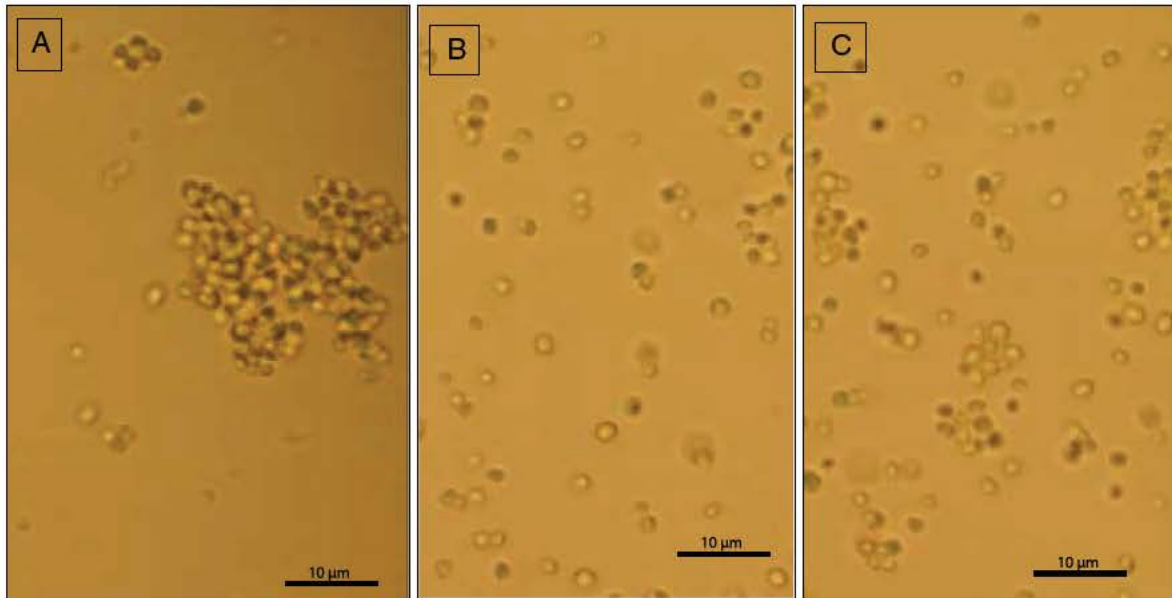

Fig. 5. Microscopic observation at high magnifications ($\times 1000$) of the *Chlorella vulgaris* cells after supercritical CO_2 (ScCO_2) extraction. (A) Control before extraction (B) After double extraction (C) After simple extraction.

decreased to $15.2 \pm 0.7\%$ by the end of the extraction. Similar lipids fraction profiles were obtained under higher pressure extraction condition (750 bar), showing no significant difference ($p > 0.05$). NL represented most of the extracts with $70.0 \pm 1.7\%$ at the beginning, rising to $83.0 \pm 3.3\%$ after 211 min, whereas the proportion of GL and PPL did not exceed $12.1 \pm 0.65\%$ and $5.3 \pm 0.3\%$, respectively, by the end of the extraction process (Fig. 7A). These results are in accordance with those reported by Temelli [29].

In this experimental set up, the yield of extracted lipids under 450 or 750 bar was essentially identical. Processing under a pressure of 450 bar, allowed the extraction of $41.9 \pm 1.2\%$ of total NL, $16.0 \pm 0.8\%$ of total GL and $4.5 \pm 0.2\%$ of total PPL initially contained in *N. oculata* (Fig. 6B). Similar results were obtained at 750 bar where $43.2 \pm 1.05\%$ of NL initially contained in *N. oculata* were extracted (Fig. 7B). The GL and PPL extraction curves rapidly reached steady state, yielding $14.7 \pm 0.8\%$ and $3.8 \pm 0.2\%$ of their total content, respectively. These results were better than those obtained by Patil et al. [9] in terms of experimental simplicity, selectivity, and purity of extract. They subjected *Nannochloropsis* biomass to microwave pretreatment prior to supercritical extraction to improve the efficiency

of NL extraction and added an azeotropic mixture (hexane/ethanol) as co solvent to enhance ScCO_2 fluid affinity towards NL. In terms of selectivity, our results were also better than those of Tang et al. [30] who obtained a partial fraction of total lipid content using ethanol (95%, v/v) as co solvent under high pressure, which increased the co extraction of polar lipids, necessitating then further purification steps.

Increasing the pressure from 450 to 750 bar did not provide any additional benefit in terms of NL extraction yield. Global yields at $t = 210$ min were essentially the same, in accordance with the results of Crampon et al. [31] who reported a negligible difference in the yield of extracted lipids from *N. oculata* between 500 and 850 bar.

Contrary to GL and PPL, the NL extraction yield continued to linearly increase even after 4 h, under both applied pressures, and would have reached much higher values if the extraction time was prolonged. This may be due to high pressure causing the formation of holes in the microalgae cell wall, allowing ScCO_2 to reach the NL located in the cytoplasm as droplets, and extract them. The yield of GL and PPL reached a steady state after 2 h, suggesting that the external cell wall and membranes of the inner organelles, rich in polar lipids, were not substantially damaged and supporting the hypothesis of holes

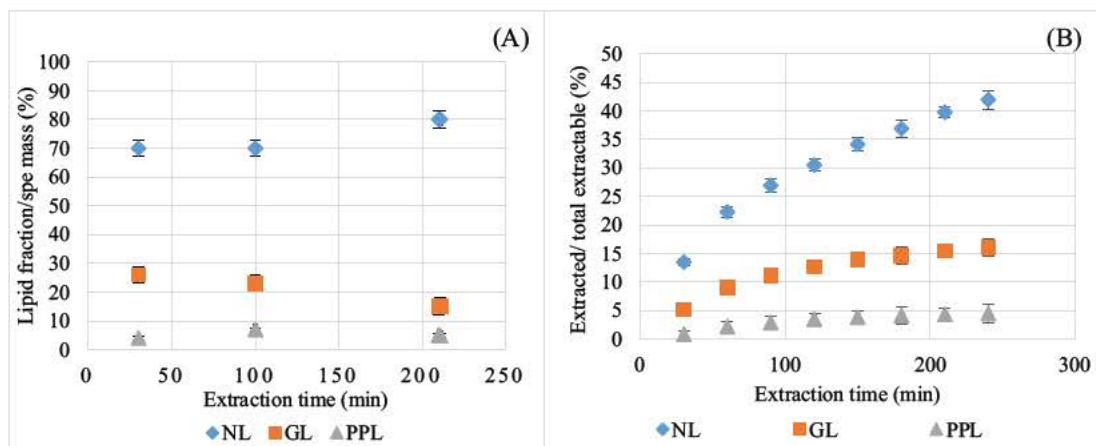

Fig. 6. Variation of proportions (A) and yield (B) of NL (neutral lipids), GL (glycolipids) and PPL (phospholipids) in the supercritical CO_2 (ScCO_2) extracts of *Nannochloropsis oculata* over time (450 bar and 50°C). Data shown as mean \pm SD ($n = 3$).

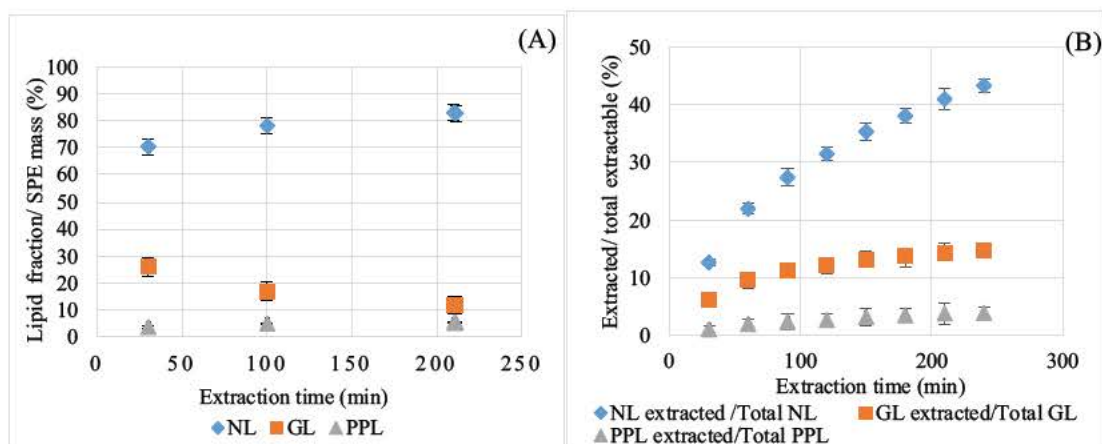

Fig. 7. Variation of proportions (A) and yield (B) of NL (neutral lipids), GL (glycolipids) and PPL (phospholipids) in the supercritical CO₂ (ScCO₂) extracts of *Nannochloropsis oculata* over time (750 bar and 50 °C). Data shown as mean ± SD (n = 3).

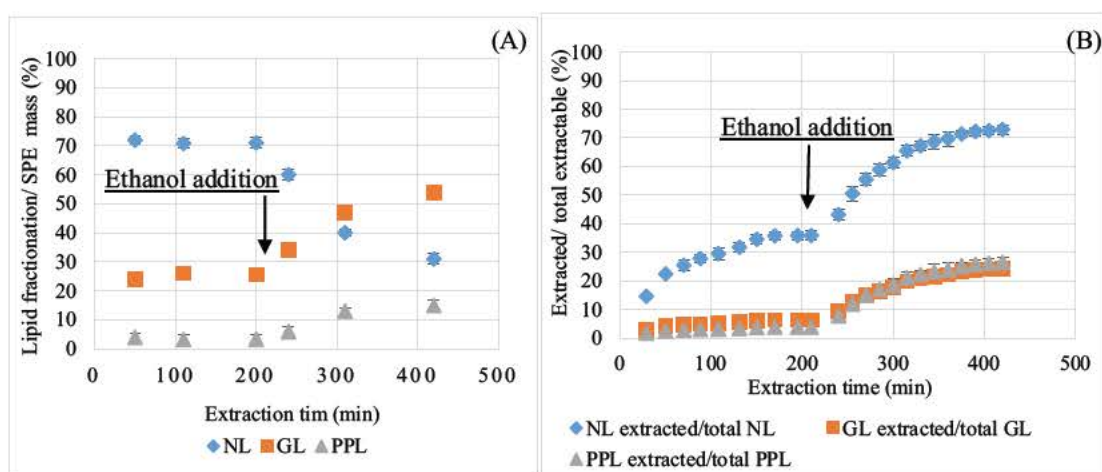

Fig. 8. Variation of proportions (A) and yield (B) of NL (neutral lipids), GL (glycolipids) and PPL (phospholipids) in the supercritical CO₂ (ScCO₂) of *Chlorella vulgaris* extracts after double extraction over time. Data shown as mean ± SD (n = 3).

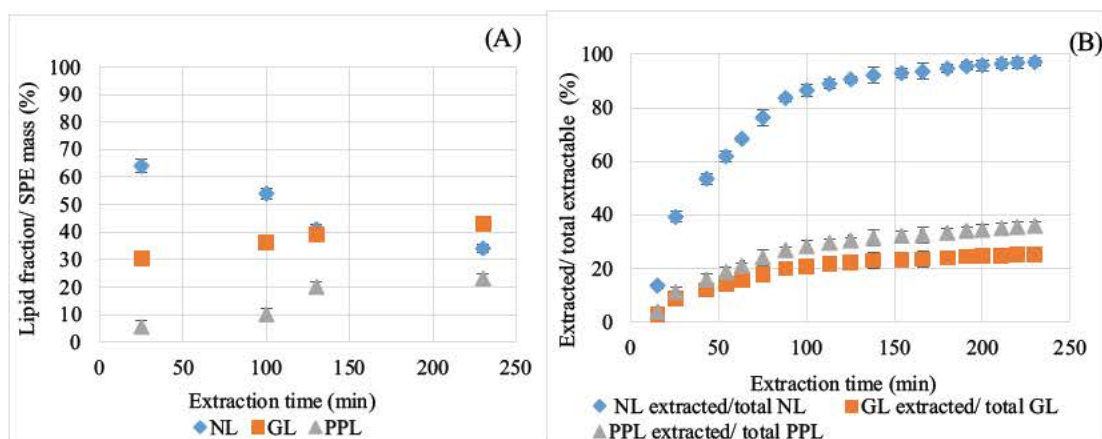

Fig. 9. Variation of proportions (A) and yield (B) of NL (neutral lipids), GL (glycolipids) and PPL (phospholipids) in the supercritical CO₂ (ScCO₂) of *Chlorella vulgaris* extracts after simple extraction over time. Data shown as mean ± SD (n = 3).

formation in the membranes rather than complete disintegration. In general, the amount of extractable solute depends on the percentage of microalgae cells opened by the disintegration step (not used in our study) and the fact that the solute from intact cells is not available for extraction by ScCO₂. The formation of holes through exposure to ScCO₂ was reported in the study of Solana et al. [32].

NL extraction may be also influenced by the contact time with the solvent. This suggests an effect of residence time in which more adsorption sites of lipid molecules may be damaged over time, resulting in a longer time for the extraction to reach equilibrium. Our results suggest that a longer extraction time for both extraction conditions (450 and 750 bar) would increase the yield of NL only. Consequently, the

final product becomes purer and consists mainly of NL. This may avoid extensive purification steps, which could compensate for the costs as associated with the long extraction time.

3.3.2. *C. vulgaris* extracts composition

We fractionated samples of total lipids extracts obtained from *C. vulgaris* under double extraction (ScCO₂ followed by ScCO₂ + ethanol 10% as co solvent added at t = 210 min) into NL, GL, and PPL, by the SPE technique (Fig. 8). It can be seen that during the first stage of double extraction that NL represented 70.2 ± 2.5% of the obtained extracts when using only ScCO₂ as solvent. PPL were a minor fraction (5.0 ± 0.3%), whereas GL represented 25.3 ± 1.3% of the extracted material (Fig. 8A). Moreover, the yield of extracted GL and PPL was relatively low (6.7 and 3.5%, respectively), whereas almost 35.8 ± 0.9% of the total NL originally contained in *C. vulgaris* were extracted. The addition of ethanol to the stabilized extraction (at t = 210 min) significantly increased the NL, PPL, and GL extraction yield. Almost 72.9 ± 1.3% of total NL, 26.4 ± 1.5% of total PPL, and 26.1 ± 1.2% of total GL were obtained by the end of extraction (Fig. 8B). These results may be due to the increase in the polarity of the medium after the injection of ethanol which may boost the extraction of both polar and non polar lipids as reported by Moreau et al. [28] and Temelli [29].

Adding ethanol (10% v/v) at the beginning of the extraction did not give the same results as those of the double extraction. The NL fraction represented 64.1 ± 2.9% of the initial extracts but decreased to 34.0 ± 1.6% by the end of extraction (Fig. 9A). The GL and PPL fractions progressively increased over time to reach after 230 min 43.5 ± 1.7% and 23.0 ± 0.9% of the total extract, respectively.

Using simple extraction, the steady state was promptly reached for all lipid fractions (Fig. 9B). However, in this case, the extraction yield of NL was higher (97.1 ± 0.5%) than that for GL and PPL (25.3 ± 1.0% and 35.9 ± 1.5%, respectively). Our results competed with Moradi Kheibari and Ahmadzadeh [33] who studied NL extraction from *C. vulgaris* using ScCO₂ with a disruption step and a higher pressure.

Furthermore, the NL extraction yield was higher than that obtained by double extraction. This could be explained by the fact that the extraction of polar lipids may promote the extraction of NL due to existing interactions between different types of lipids (polar/non polar) [28] [29]. Using double extraction, the lipid molecules remaining in the matrix from the first stage become highly viscous and form agglomerates that hindered their diffusion during the second step [34]. This could limit the extraction of NL remaining in the biomass which could not pass through the non disintegrated cell wall as shown by microscopic observation.

4. Conclusion

During this study, ScCO₂ extraction was carried out for selective recovery of neutral lipids from *C. vulgaris* and *N. oculata* microalgae without preliminary cell disruption step. Extraction yield of total lipids from *N. oculata* at 450 and 750 bar (20%) was higher than that at 250 bar (15%). Neutral lipids extracts from *N. oculata* represented 83% of total lipids extracts, whereas the proportion of glycolipids and phospholipids did not exceed 12.1% and 5.3%, respectively. Adding ethanol (10% v/v) as co solvent led to the extraction of 97% of neutral lipids from *C. vulgaris*.

Residues from ScCO₂ extraction, composed mainly of hydrophilic fraction (proteins, polysaccharides), will undergo in future study an optimized aqueous extraction, in aim to recover total protein fraction without any cell disruption pretreatment. This deals with the fundamental algorefinery concept, by taking advantages from the whole biomass components, making the large scale application of microalgae feasible and economically viable.

Conflict of interest

The authors declare no conflict of interest.

References

- [1] S. Bellou, M.N. Baeshen, A.M. Elazzazy, D. Aggeli, F. Sayegh, G. Aggelis, Microalgal lipids biochemistry and biotechnological perspectives, *Biotechnol. Adv.* 32 (8) (Dec. 2014) 1476–1493.
- [2] T. Bradley, D. Maga, S. Antón, Unified approach to Life Cycle Assessment between three unique algae biofuel facilities, *Appl. Energy* 154 (Sep. 2015) 1052–1061.
- [3] L. Brennan, P. Owende, Biofuels from microalgae—a review of technologies for production, processing, and extractions of biofuels and co-products, *Renew. Sust. Energy. Rev.* 14 (2) (Feb. 2010) 557–577.
- [4] L. Lardon, A. Hélias, B. Sialve, J.-P. Steyer, O. Bernard, Life-cycle assessment of biodiesel production from microalgae, *Environ. Sci. Technol.* 43 (17) (Sep. 2009) 6475–6481.
- [5] R. Ranjith Kumar, P. Hanumantha Rao, M. Arumugam, Lipid extraction methods from microalgae: a comprehensive review, *Front. Energy Res.* 2 (Jan. 2015).
- [6] M.K. Lam, K.T. Lee, Microalgae biofuels: a critical review of issues, problems and the way forward, *Biotechnol. Adv.* 30 (3) (May 2012) 673–690.
- [7] A. García, A. de Lucas, J. Rincón, A. Alvarez, I. Gracia, M.A. García, Supercritical carbon dioxide extraction of fatty and waxy material from rice bran, *J. Am. Oil Chem. Soc.* 73 (9) (Sep. 1996) 1127–1131.
- [8] J. Lorenzen, et al., Extraction of microalgae derived lipids with supercritical carbon dioxide in an industrial relevant pilot plant, *Bioprocess Biosyst. Eng.* 40 (6) (2017) 911–918.
- [9] P.D. Patil, K.P.R. Dandamudi, J. Wang, Q. Deng, S. Deng, Extraction of bio-oils from algae with supercritical carbon dioxide and co-solvents, *J. Supercrit. Fluids* 135 (May 2018) 60–68.
- [10] C.-H. Cheng, T.-B. Du, H.-C. Pi, S.-M. Jang, Y.-H. Lin, H.-T. Lee, Comparative study of lipid extraction from microalgae by organic solvent and supercritical CO₂, *Bioresour. Technol.* 102 (21) (Nov. 2011) 10151–10153.
- [11] C. Crampon, et al., Oil extraction from enriched *Spirulina platensis* microalgae using supercritical carbon dioxide, *J. Supercrit. Fluids* 119 (Jan. 2017) 289–296.
- [12] C. Safi, et al., Aqueous extraction of proteins from microalgae: effect of different cell disruption methods, *Algal Res.* 3 (Jan. 2014) 61–65.
- [13] K. Ramluckan, K.G. Moodley, F. Bux, An evaluation of the efficacy of using selected solvents for the extraction of lipids from algal biomass by the soxhlet extraction method, *Fuel* 116 (Jan. 2014) 103–108.
- [14] J. Jeon, et al., New mixture composition of organic solvents for efficient extraction of lipids from *Chlorella vulgaris*, *Biomass Bioenergy* 59 (Dec. 2013) 279–284.
- [15] Y. Du, B. Schuur, S.R.A. Kersten, D.W.F. Brilman, Opportunities for switchable solvents for lipid extraction from wet algal biomass: an energy evaluation, *Algal Res.* 11 (Sep. 2015) 271–283.
- [16] P. Juaneda, G. Rocquelin, Rapid and convenient separation of phospholipids and non phosphorus lipids from rat heart using silica cartridges, *Lipids* 20 (1) (Jan. 1985) 40–41.
- [17] M. Olofsson, et al., Combined effects of nitrogen concentration and seasonal changes on the production of lipids in *Nannochloropsis oculata*, *Mar. Drugs* 12 (4) (Mar. 2014) 1891–1910.
- [18] A. Widjaja, C.-C. Chien, Y.-H. Ju, Study of increasing lipid production from fresh water microalgae *Chlorella vulgaris*, *J. Taiwan Inst. Chem. Eng.* 40 (1) (Jan. 2009) 13–20.
- [19] M. Piorreck, K.-H. Baasch, P. Pohl, Biomass production, total protein, chlorophylls, lipids and fatty acids of freshwater green and blue-green algae under different nitrogen regimes, *Phytochemistry* 23 (2) (Jan. 1984) 207–216.
- [20] S. Ötles, R. Pire, Fatty Acid Composition of *Chlorella* and *Spirulina* Microalgae Species, [Online]. Available: <http://www.ingentaconnect.com/content/aoac/jaoac/2001/00000084/00000006/art00007>, (Nov-2001) (Accessed: 30-May-2018).
- [21] G. Van Vooren, F. Le Grand, J. Legrand, S. Cuiñé, G. Peltier, J. Pruvost, Investigation of fatty acids accumulation in *Nannochloropsis oculata* for biodiesel application, *Bioresour. Technol.* 124 (Nov. 2012) 421–432.
- [22] A.L. Stephenson, J.S. Dennis, C.J. Howe, S.A. Scott, A.G. Smith, Influence of nitrogen-limitation regime on the production by *Chlorella vulgaris* of lipids for biodiesel feedstocks, *Biofuels* 1 (1) (Jan. 2010) 47–58.
- [23] J. Shi, C. Yi, S.J. Xue, Y. Jiang, Y. Ma, D. Li, Effects of modifiers on the profile of lycopene extracted from tomato skins by supercritical CO₂, *J. Food Eng.* 93 (4) (Aug. 2009) 431–436.
- [24] A. Cháfer, T. Fornari, A. Berna, E. Ibañez, G. Reglero, Solubility of solid carnosic acid in supercritical CO₂ with ethanol as a co-solvent, *J. Supercrit. Fluids* 34 (3) (Jul. 2005) 323–329.
- [25] G. Andrich, U. Nesti, F. Venturi, A. Zinnai, R. Fiorentini, Supercritical fluid extraction of bioactive lipids from the microalga *Nannochloropsis* sp. *Eur. J. Lipid Sci. Technol.* 107 (6) (Jun. 2005) 381–386.
- [26] H. Xing, B. Su, Q. Ren, Y. Yang, Adsorption equilibria of artemisinin from supercritical carbon dioxide on silica gel, *J. Supercrit. Fluids* 49 (2) (Jun. 2009) 189–195.
- [27] M. Perrut, J.Y. Clavier, M. Poletto, E. Reverchon, Mathematical modeling of sunflower seed extraction by supercritical CO₂, *Ind. Eng. Chem. Res.* 36 (2) (Feb. 1997) 430–435.
- [28] R.A. Moreau, M.J. Powell, V. Singh, Pressurized liquid extraction of polar and nonpolar lipids in corn and oats with hexane, methylene chloride, isopropanol, and ethanol, *J. Am. Oil Chem. Soc.* 80 (11) (Nov. 2003) 1063–1067.

- [29] F. Temelli, Extraction of triglycerides and phospholipids from canola with supercritical carbon dioxide and ethanol, *J. Food Sci.* 57 (2) (1992) 440–443.
- [30] S. Tang, C. Qin, H. Wang, S. Li, S. Tian, Study on supercritical extraction of lipids and enrichment of DHA from oil-rich microalgae, *J. Supercrit. Fluids* 57 (1) (May 2011) 44–49.
- [31] C. Grampon, A. Mouahid, S.-A.A. Toudji, O. Lépine, E. Badens, Influence of pre-treatment on supercritical CO₂ extraction from *Nannochloropsis oculata*, *J. Supercrit. Fluids* 79 (Jul. 2013) 337–344.
- [32] M. Solana, C.S. Rizza, A. Bertucco, Exploiting microalgae as a source of essential fatty acids by supercritical fluid extraction of lipids: comparison between *Scenedesmus obliquus*, *Chlorella protothecoides* and *Nannochloropsis salina*, *J. Supercrit. Fluids* 92 (Aug. 2014) 311–318.
- [33] N. Moradi-kheibari, H. Ahmadzadeh, Supercritical carbon dioxide extraction and analysis of lipids from *Chlorella vulgaris* using gas chromatography, *J. Iran. Chem. Soc.* 14 (11) (Nov. 2017) 2427–2436.
- [34] G. Yoo, et al., An effective, cost-efficient extraction method of biomass from wet microalgae with a functional polymeric membrane, *Green Chem.* 16 (1) (2014) 312–319.