



**HAL**  
open science

# **A review of ternary azeotropic mixtures advanced separation strategies**

Weifeng Shen, H. Benyounes, J. Song

► **To cite this version:**

Weifeng Shen, H. Benyounes, J. Song. A review of ternary azeotropic mixtures advanced separation strategies. *Teoreticheskie Osnovy Khimicheskoi Tekhnologii / Theoretical Foundations of Chemical Engineering*, 2016, 50 (1), pp.28-40. <10.1134/S0040579516010140>. <hal-02134875>

**HAL Id: hal-02134875**

**<https://hal.science/hal-02134875v1>**

Submitted on 20 May 2019

HAL is a multi-disciplinary open access archive for the deposit and dissemination of scientific research documents, whether they are published or not. The documents may come from teaching and research institutions in France or abroad, or from public or private research centers.

L'archive ouverte pluridisciplinaire HAL, est destinée au dépôt et à la diffusion de documents scientifiques de niveau recherche, publiés ou non, émanant des établissements d'enseignement et de recherche français ou étrangers, des laboratoires publics ou privés.



HAL Authorization



## Open Archive Toulouse Archive Ouverte (OATAO)

OATAO is an open access repository that collects the work of some Toulouse researchers and makes it freely available over the web where possible.

This is an author's version published in: <http://oatao.univ-toulouse.fr/20565>

**Official URL:** <https://doi.org/10.1134/S0040579516010140>

### To cite this version:

Shen, Weifeng and Benyounes, H. and Song, J. A review of ternary azeotropic mixtures advanced separation strategies. (2016) Theoretical Foundations of Chemical Engineering, 50 (1). 28-40. ISSN 0040-5795

Any correspondence concerning this service should be sent to the repository administrator:

[tech-oatao@listes-diff.inp-toulouse.fr](mailto:tech-oatao@listes-diff.inp-toulouse.fr)

# A Review of Ternary Azeotropic Mixtures Advanced Separation Strategies<sup>1</sup>

W. F. Shen<sup>a</sup>, H. Benyounes<sup>b</sup>, and J. Song<sup>c</sup>

<sup>a</sup>Université de Toulouse, INP, UPS, LGC (Laboratoire de Génie Chimique), Toulouse, France

<sup>b</sup>U.S.T. Oran, Laboratoire de Chimie Physique des Matériaux, Catalyse et Environnement, Oran, Algérie

<sup>c</sup>Chinese Academy of Sciences, National Engineering Laboratory for Hydrometallurgical Cleaner Production Technology, Institute of Process Engineering, Beijing, China

e-mail: bhassba@yahoo.fr

**Abstract**—In most multi-component systems, the predominant non-ideality occurs which lead to the occurrence of an azeotrope. The ternary systems classification and study are summarized in first part of this review. The next part covers thermodynamic knowledge of residue curve maps, univolatility and unidistribution curves. A feasibility criterion based on thermodynamic properties of ternary diagram is presented, they are considered as powerful tool for the flow-sheet development and conceptual design. Separation of azeotropic mixtures and close boiling mixtures require non-conventional distillation processes, among which the leading processes are pressure-swing distillation if the composition of the azeotrope changes significantly with pressure, azeotropic distillation, extractive distillation, reactive distillation, and salt-effect distillation. The final section provides an overview of concepts, history, and recent strategies in these non-conventional distillations.

**Keywords:** azeotropic mixtures, thermodynamic analysis, residue curve maps, extractive distillation

**DOI:** 10.1134/S0040579516010140

## INTRODUCTION

In most separation systems, the predominant non ideality occurs in the liquid phase because of molecular interactions. Negative (attraction) or positive (repulsion) deviations tend to induce maximum- or minimum-boiling azeotrope, respectively. The study of the thermodynamic classification of liquid-vapor phase equilibrium diagrams for ternary mixtures and its topological interpretation has a long history. Considering a ternary diagram A–B–C, where the components A, B, C are ranked in the order of their boiling temperature “light, intermediate and heavy”, respectively, the classification of azeotropic mixtures in 113 classes was first proposed by Matsuyama [1]. As explained by Hilmen [2, 3], Serafimov extended the work of Gurikov and applied the total number of binary azeotropes  $M$  and the number of ternary azeotropes  $T$  as classification parameters. These classes are further divided into types and subtypes denoted by a number and a letter. Serafimov’s classification is presented graphically in Fig. 1. The transition from one antipode to the other can be made by simply changing the signs of the nodes and inverting the direction of the arrows and the correspondence between Matsuyama and Serafimov’s classification is detailed in [4].

Ternary systems are studied in this paper on the basis of Serafimov’s classification that includes 26 classes of feasible topological structures of VLE diagrams for ternary mixtures [5]. The entrainer E is conventionally defined by its boiling temperature with respect to the binary mixture A–B to separate: a heavy entrainer E has a boiling temperature higher than A and B, an intermediate entrainer E has a boiling temperature between the A and B, a light entrainer E has a boiling temperature lower than A and B.

In industry, extractive distillation entrainer is usually chosen as a heavy “high boiling” component mixtures [6–11]. Continuous extractive distillation studies have always considered a heavy entrainer to split a minimum boiling azeotrope. Theoretically, any candidate entrainer satisfying the feasibility and optimal criteria can be used no matter it is heavy, light, or intermediate entrainer. Literature studies on intermediate entrainer or light entrainer validate this assumption [12–16]. Tables 1 and 2 provide the information on literature for each ternary system.

## THERMODYNAMIC ANALYSIS STRATEGIES

As Laroche et al. [16] showed for the 1.0–1a class, knowledge of the residue curve map (RCM) and of the location of the univolatility curve  $\alpha_{AB} = 1$  can help

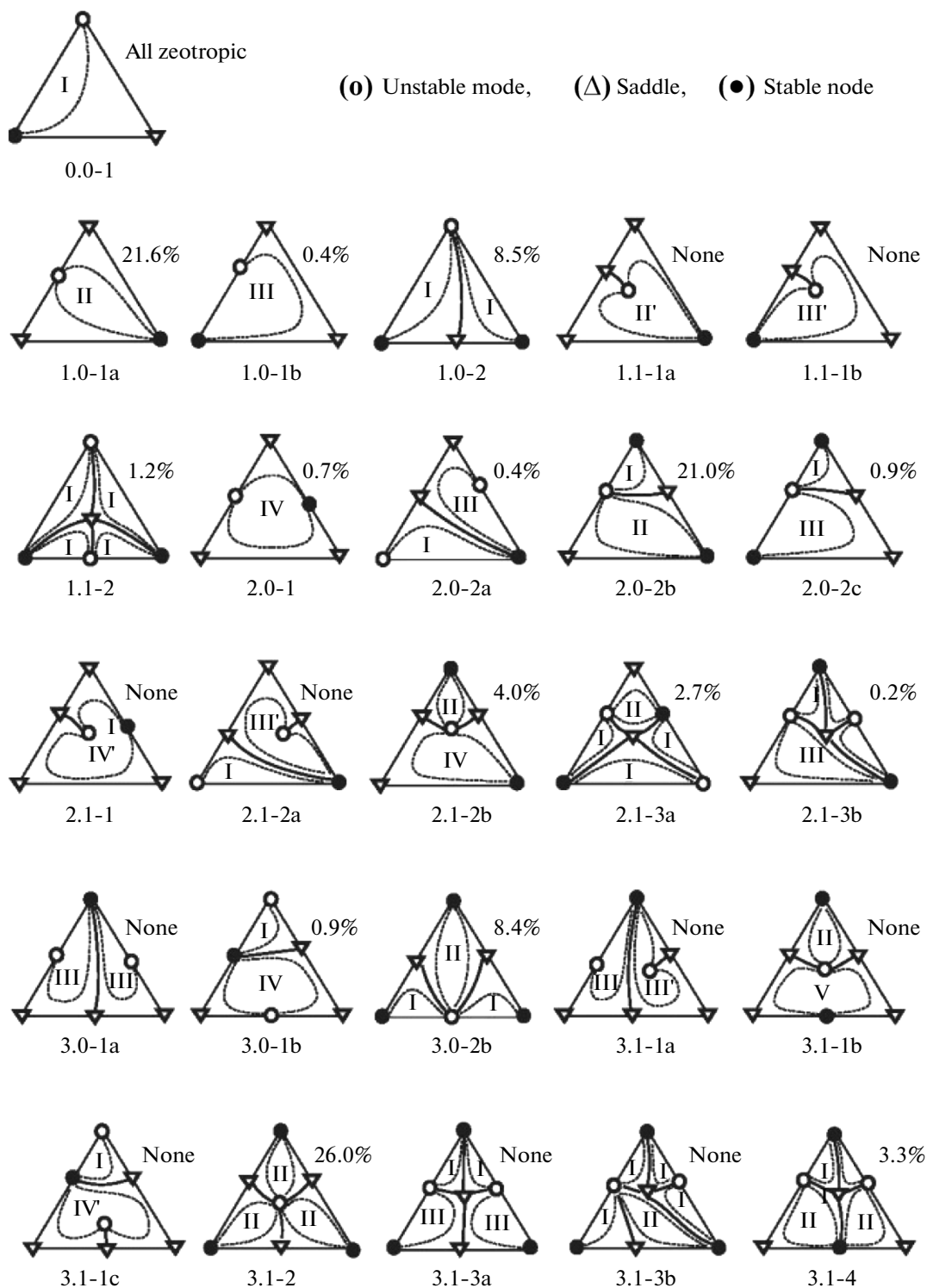

Fig. 1. Azeotropic ternary mixture: Serafimov's 26 topological classes and Reshetov's statistics [4].

assess which product is removed in the distillate when using a light, intermediate or heavy entrainer.

The paper is devoted to present a brief description of thermodynamic insight conceptual and thermody-

amic tools, investigate how to assess the feasibility using established thermodynamic criterion, and present a comprehensive survey of new finding systematic approaches applied for azeotropic mixture separation schemes.

**Table 1.** The most important literatures concerning extractive distillation separation of different azeotropic types with different entrainer types

Entrainer type	Azeotrope type	Serafimov class	Volatility order	Authors
Heavy	Minimum	1.0-1a	Az > A > B > E	Yatim, 1993 [17] Lang et al., 1994 [18] Laroche et al., 1992 [16] Knapp and Doherty, 1994 [19] Lelkes et al., 1998, 1998 [20–21] Brüggemann et al., 2004 [22] Luyben, 2008, 2008 [23–24] Rodriguez-Donis et al., 2009 [8] Shen et al., 2013 [9] Benyounes et al., 2014 [10] Benyahia et al., 2014 [11]
	Maximum	1.0-2	A > B > Az > E	Lang et al., 2000 [25–26] Rodriguez-Donis et al., 2009 [8] Shen et al., 2013 [9] Benyounes et al., 2014 [10]
	Close boiling	0.0-1	A > B > E	Lang et al., 1994 [18] Rodriguez-Donis et al., 2009 [27]
Intermediate	Minimum	1.0-1b	Az > A > E > B	Rev et al., 2003 [28] Varga, 2003 [29] Rodriguez-Donis et al., 2012 [30]
	Maximum	1.0-1b	A > E > B > Az	Bernot et al., 1990 [31] Lelkes et al., 2002 [12] Rodriguez-Donis et al., 2012 [30]

## THERMODYNAMIC CONCEPTS, ANALYSIS TOOLS, AND INSIGHT CRITERIA

### *Residue Curve Map*

The residue curve map technique is considered as powerful tool for the flowsheet development and preliminary design of conventional multicomponent separation processes. A residue curve map (RCM) is a collection of the liquid residue curves in a simple one-stage batch distillation originating from different initial compositions. Using the theory of differential equations, the study of the topological properties of residue curve map is summarized in two recently articles [3–4]. Medvedev and Serafimov systematically formulated the principles of thermodynamics and topological analysis of residue curve maps, and applied to four-component systems [32].

### *Unidistribution and Relative Volatility*

The distribution coefficient and relative volatility are well-known characteristics of the vapor-liquid equilibrium. Unidistribution and univolatility line diagrams can be used to sketch the VLE diagrams and represent the topologic feature of the simple phase transformation trajectories. In batch separation, it is possible that one of the components will be distributed between the ternary components, the locus of turning points yields the unidistribution line, which is initially

discussed by Serafimov. [33] The qualitative characteristics of the distribution coefficient and relative volatility functions are typical approaches for the thermodynamic topological analysis.

Early in 1971, Serafimov et al. [34] first conducted the analysis of tangential azeotrope by using diagrams of unidistribution lines as a main tool. The composition dependency of the distribution coefficients is qualitative and quantitative characteristics of the VLE for the given mixture. In a similar way to the distribution coefficient, the relative volatility features can be represented by isovolatility lines. Then the system of univolatility lines where  $\alpha_{ij} = 1$  was proposed. It is evident that the point of a binary azeotrope gives rise to univolatility line and that the point of a ternary azeotrope gives rise to the three univolatility lines. These features are represented in Fig. 2 for the most probable classes. The main aim of their work was to consider feasible structures of the residue curve maps in more detail, and in fact this study helped to popularize more refined classification of the ternary diagrams. The diagrams of unidistribution lines were used as a main tool for analysis of tangential azeotrope. Serafimov et al. presented basic diagram structures for extractive distillation systems with the aid of analyzing relative volatility  $\alpha = 1$  lines and pseudo-ideal lines is for the case in which the mixture to be separated is biazeotropic. [35] Recently, based on the achievement of Serafimov's

**Table 2.** The study cases concerning extractive distillation separation of different azeotropic types with different entrainer types

Entrainer type	Azeotrope type	Class	Volatility order	Case study		
Heavy	Minimum	1.0-1a	$Az > A > B > E$	Acetone	Methanol	Water
				Acetone	Methanol	Isopropanol
				Acetone	Methanol	Ethanol
				Acetone	Methanol	Chlorobenzene
	Maximum	1.0-2	$A > B > Az > E$	Acetone	Chloroform	Benzene
				Acetone	Chloroform	Toluene
				Vinyl acetate	Butyl acetate	Chloroform
	Close boiling	0.0-1	$A > B > E$	Ethyl acetate	Benzene	Butanol
				Heptane	Toluene	Phenol
				Heptane	Toluene	Chlorobenzene
				Ethyl acetate	Benzene	Hexanol
	Intermediate	Minimum	1.0-1b	$Az > A > E > B$	Methyl acetate	Cyclohexane
Maximum		1.0-1b	$A > E > B > Az$	Methanol	Toluene	Triethylamine
Light	Minimum	1.0-2	$E > Az > A > B$	Chloroform	Ethyl acetate	2-chlorobutane
				Ethanol	Water	Methanol
				Ethanol	Toluene	Acetone
	Maximum	1.0-1a	$E > A > B > Az$	MEK	Benzene	Acetone
				Water	Ethylenediamine	Methanol
				Acetone	Chloroform	DCM
	Close boiling	0.0-1	$E > A > B$	Propanoic acid	DMF	MIBK
			Chlorobenzene	Ethylbenzene	4-methylheptane	

group in topological theory on ternary system [36–38], Rodriguez-Donis et al. [8] studied how univolatility lines split the composition triangle into regions of certain order of volatility of components and defined a general feasibility criterion for extractive distillation under infinite reflux ratio. In this work we consider unidistribution and univolatility line diagrams for the purpose of sketching the volatility order region and thus of assessing the feasible structures which will give possible products and offer information of possible limitation of entrainer feed.

#### *Thermodynamic Insight on Feasibility*

Completion and extension of thermodynamic insight to other mixture classes was published by Petlyuk et al. [39] combining knowledge of the thermodynamic properties of residue curve maps and of the univolatility and unidistribution curves location, Rodriguez-Donis et al. [8, 14, 27, 30] expressed a general feasibility criterion for extractive distillation under infinite reflux ratio: “*Homogeneous extractive distillation of a A–B mixture with entrainer E feeding is feasible if there exists a residue curve connecting E to A or B following a decreasing or increasing temperature direction inside the region where A or B are the most volatile or the*

*heaviest component of the mixture*”. The volatility order is set by the univolatility curves which knowledge is therefore critical. Using illustrative examples covering all sub-cases, but exclusively operated in batch extractive distillation, Rodriguez-Donis and colleagues found that Serafimov’s classes covering up to 53% of azeotropic mixtures were suited for extractive distillation: 0.0–1 (close boiling mixtures), 1.0–1a, 1.0–1b, 1.0–2 (azeotropic mixtures with light, intermediate or heavy entrainers forming no new azeotrope), 2.0–1, 2.0–2a, 2.0–2b and 2.0–2c (azeotropic mixtures with an entrainer forming one new azeotrope). For all suitable classes, the general criterion under infinite reflux ratio could explain the product to be recovered and the possible existence of limiting values for the entrainer feed flowrate ratio for batch operation. Figure 3 displays residue curve map and extractive profiles map of 1.0–2 mixtures with respect to batch extractive distillation at infinite reflux and infinite small feed ratios. The residue unstable node,  $[UN_{rcm}]$ , in Fig. 3a becomes extractive stable node,  $[SN_{ext, A}]$ , in Fig. 3b on the contrary, the residue stable node,  $[SN_{rcm}]$ , is equivalent to extractive unstable node,  $[UN_{ext}]$ . In Fig. 3b, the  $\alpha_{AB} = 1$  curve intersects binary side A-E at the so-called point  $x_p$ , which defines the different order of volatile regions and feasible ranges.

## THE STRATEGIES IN NON-CONVENTIONAL DISTILLATION FOR AZEOTROPIC MIXTURES

The separation in distillation processes are based on the differences on the vapor and liquid phase compositions of the mixture arising from successive partial vaporization and condensation steps, distillation process is a method for separating various components of a liquid solution depending upon the distribution of these components between a vapor phase and a liquid phase. However, in case of a close-boiling mixture, these differences in the compositions of the vapor and the liquid phase become small. The separation of non-ideal mixtures, azeotropic ones and close boiling ones, is the second major incentive for distillation research. Close boiling mixtures require many vaporization or condensation steps, columns and bigger reflux ratio and process often becomes uneconomical both in equipment investment and operating cost by conventional distillation. Azeotropic mixtures also require advanced techniques to facilitate separation. To separate non ideal mixtures in continuous operation, pressure swing, azeotropic and extractive distillation processes are the most common in industry and are well described in numerous textbooks [6, 40]. The most common non-conventional distillation alternatives involve changing the operating pressure (pressure-swing distillation) adding of an entrainer, either with the load (azeotropic distillation) or at another location than the load (extractive distillation). All of these special techniques are ultimately based on the same differences in the vapor and liquid compositions as ordinary distillation, but, in addition, they rely on some additional mechanism to further modify the vapor-liquid behavior of the key components. These enhanced techniques can be classified according to

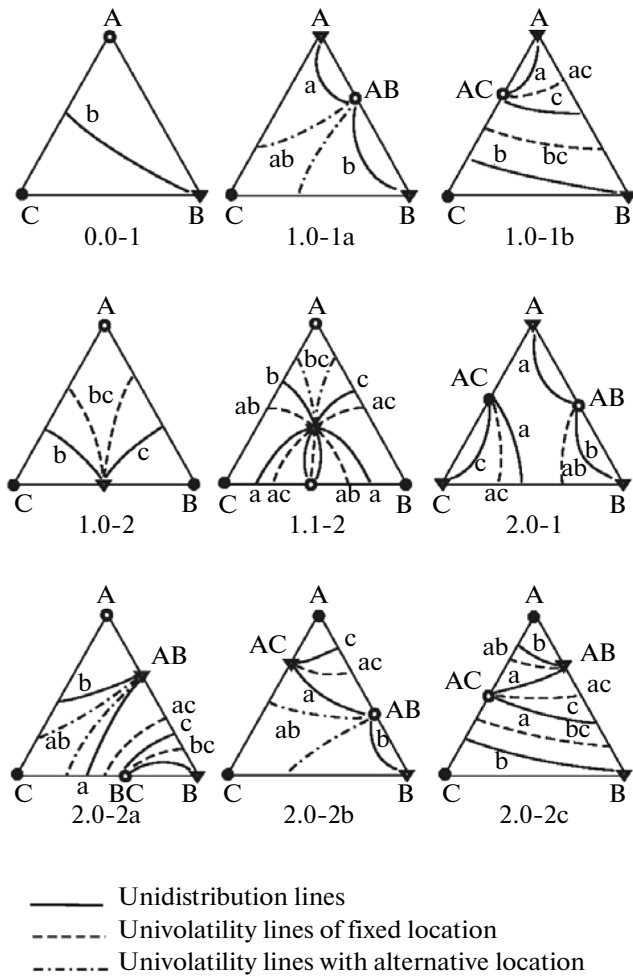

**Fig. 2.** Unidistribution and univolatility line diagrams for the most probable classes of ternary mixtures according to Reshetov's statistics [3].

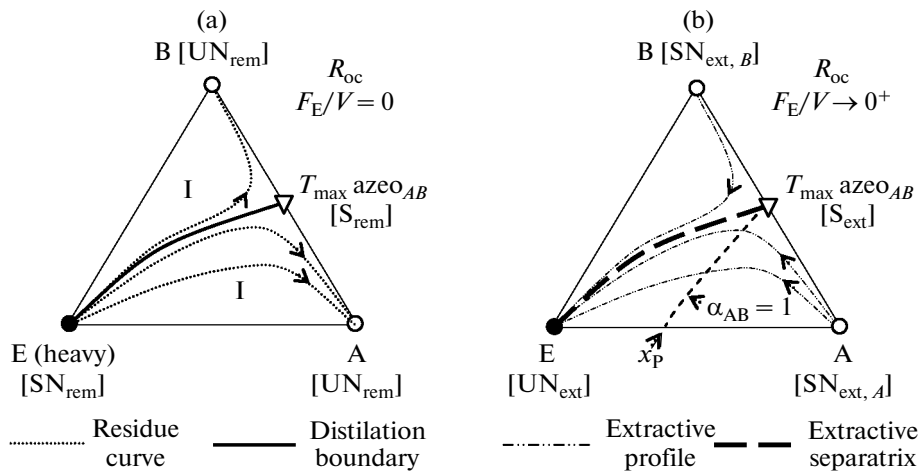

**Fig. 3.** Thermodynamic features of 1.0–2 mixtures with respect to batch extractive distillation: (a) Residue curve map, (b) Extractive profiles map.

their effect on the relationship between the vapor and liquid compositions: 1—azeotropic distillation and pressure-swing distillation are methods that cause or exploit azeotrope formation or behavior to alter the boiling characteristics and separability of the mixture; 2—extractive distillation and salt distillation are methods that primarily modify liquid-phase behavior to alter the relative volatility of the components of the mixture; 3—reactive distillation is a method that uses chemical reaction to modify the composition of the mixture or, alternatively, use existing vapor-liquid differences between reaction products and reactants to enhance the performance of a reaction.

### *Strategies in Extractive Distillation*

Extractive distillation is a powerful and widely used technique for separating azeotropic and close boiling mixtures in pharmaceutical and chemical industries. Given an azeotropic mixture A–B (with A having a lower boiling temperature than B), an entrainer E is added to interact selectively with the original components and alter their relative volatility, thus enhancing the original separation [41]. It differs from azeotropic distillation by the fact that the third-body solvent E is fed continuously in another column position other than mixture feed. For decades a single feasibility rule holds in industry for separating minimum boiling azeotrope: extractive distillation is defined as involving a miscible, heavy component. The solvent forms no new azeotrope and the original component with the greatest volatility separates out as the top product. The bottom product consists of a mixture of the solvent and the other component fed to the recovering column. An example is the dehydration of ethanol with ethylene glycol [42, 43]. The extractive process allows distilling ethanol, a saddle of the 1.0–1a class diagram. Several column configurations can be used for extractive distillation both in batch and continuous. In batch mode, batch extractive distillation (BED) is a process where the mixture to be separated is charged into the still whereas entrainer (E) is fed continuously. When the entrainer is added to the mixture to be separated at the beginning of the process, it belongs to solvent-enhanced batch distillation (SBD). Both BED and SBD processes can be performed either in rectifier, or in middle-vessel column, or in stripping column (Fig. 4). Steger et al. [44] emphasize that the most commonly applied configuration is the rectifier as controlling a batch rectifier is less complex than controlling a stripper.

A typical extractive distillation process is shown in Fig. 5, which includes an extractive distillation column where the solute, A, is obtained as the distillate and the mixture of raffinate, B, and solvent is exit from the bottom. A solvent recovery column comes next where the purified raffinate, B is obtained as distillate

and the solvent is recovered from the bottom and recycled to the extractive distillation column is also shown. The study on extractive distillation summarizes in following sections.

Rodriguez-Donis et al. [45] investigated the feasibility of heterogeneous extractive distillation process in a continuous column considering several feed point strategies for the entrainer recycle stream and for the main azeotropic feed. Depending on these choices, the heterogeneous distillation column is composed of one, two, or three column sections. Unlike homogeneous extractive distillation, a reflux policy composed by a single or both decanted liquid phases is considered. They also looked at the impact of the external feeding influence on the composition of the top column liquid stream, which knowledge was required to assess the feasibility. Figure 6 try to display superstructure for the extractive distillation column considering all possibilities for both the entrainer recycle and the main azeotropic feed [46]. Taking into account the seven configurations combining the entrainer recycle stream and the main azeotropic feed. The heteroazeotropic extractive distillation column is the aggregation of several parts. Each type of configuration is indicated by the number from 1 to 7 in Fig. 6, considering a high boiling entrainer, seven main configurations can be set for the heteroazeotropic continuous column as follows: (1) the recycled entrainer stream,  $F_E$ , is mixed to the azeotropic feed, along stream 1 from  $F_E$ , and fed at the same intermediate tray of the column, following stream 1 from  $F$ ; (2) the entrainer is fed to an intermediate tray, following stream 2 from  $F_E$ , as is commonly used in homogeneous extractive distillation process; (3)  $F_E$  is sent to the top as a single external stream or mixed with the liquid reflux stream; 4. both  $F_E$  and  $F$  are introduced at top of the column; 5. the entrainer  $F_E$  is sent to the decanter; 6. similar to 5, but a part of the distillate product, D, is also recycled to the decanter; 7. the main azeotropic feed  $F$  is fed at top of the column or mixed into the liquid reflux, and  $F_E$  is back directly to the decanter.

Choosing the main azeotropic feed location (intermediate or column top) and the entrainer recycle strategy (mixed with the azeotropic feed or with the top liquid reflux or sent to an intermediate column point of the column or to the decanter) leads to any of the seven configurations.

Extractive distillation has been studied for many decades with a rich literature, some main subjects studied include: 1—column with all possible configurations [48, 49]; 2—process operation policies and strategy [20, 47]; 3—process design, synthesis, optimization and determining the separation sequencing [50–51]; (5) entrainer design and selection and feasibility studies [19, 52]. The identification of possible cut under key parameters reflux ratio, reboil ratio and

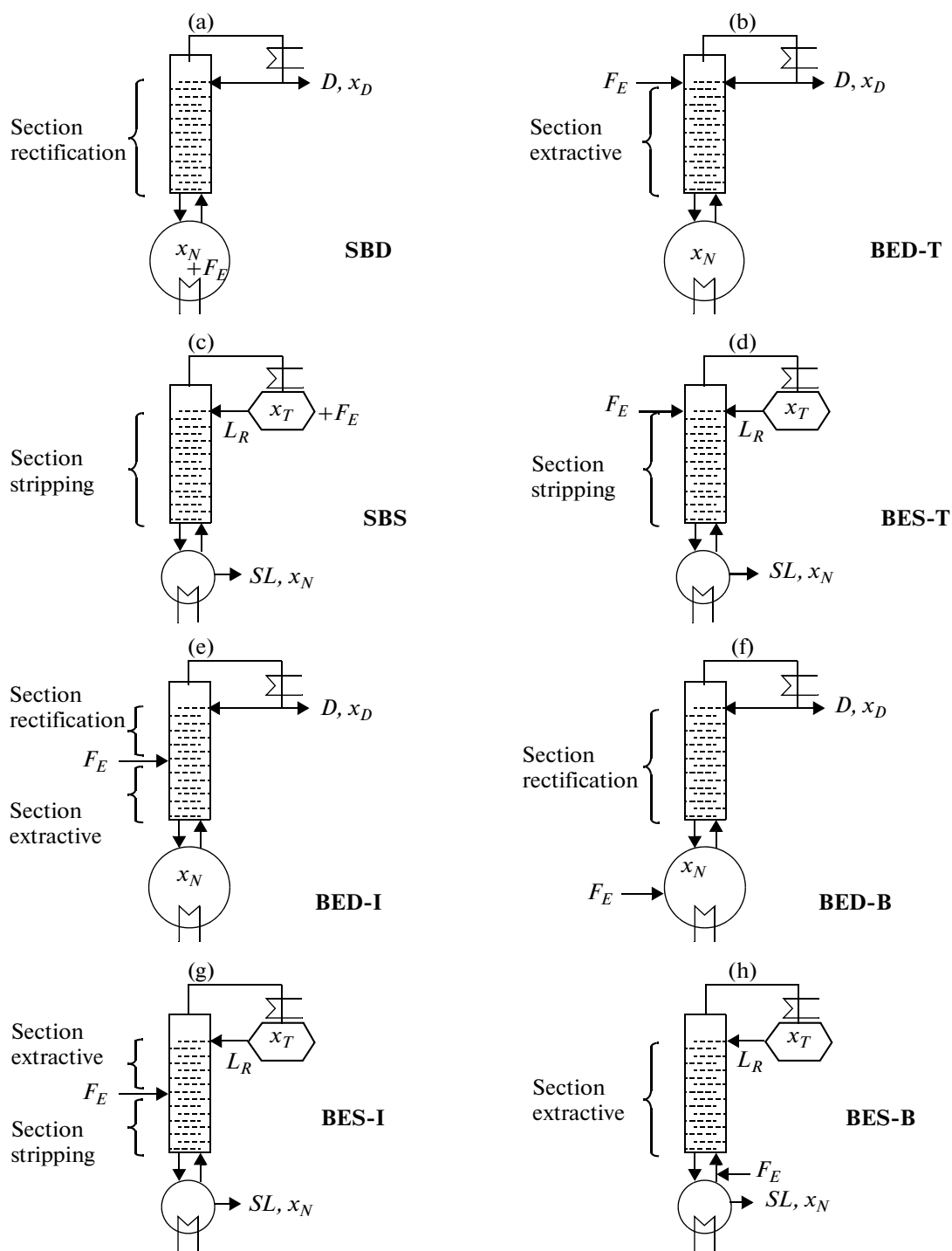

Fig. 4. Configurations of extractive batch distillation column in rectifier and stripper.

entrainer—feed flowrate ratio has been the main challenge for an efficient separation of azeotropic mixtures. Several achievements have been realized by the use of an algebraic criterion [53] or of mathematical approaches by using bifurcation theory [19]; by interval arithmetic [54] or by a combined bifurcation-shortcut rectification body method [22].

#### Strategies in Pressure-Swing Distillation

Pressure-swing distillation is a method for separating a pressure-sensitive azeotrope that utilizes two columns operated in sequence at two different pressures if concentration of the azeotrope changes significantly with pressure [55]. Generally, the composition of component A (light in the azeotropic mixture)

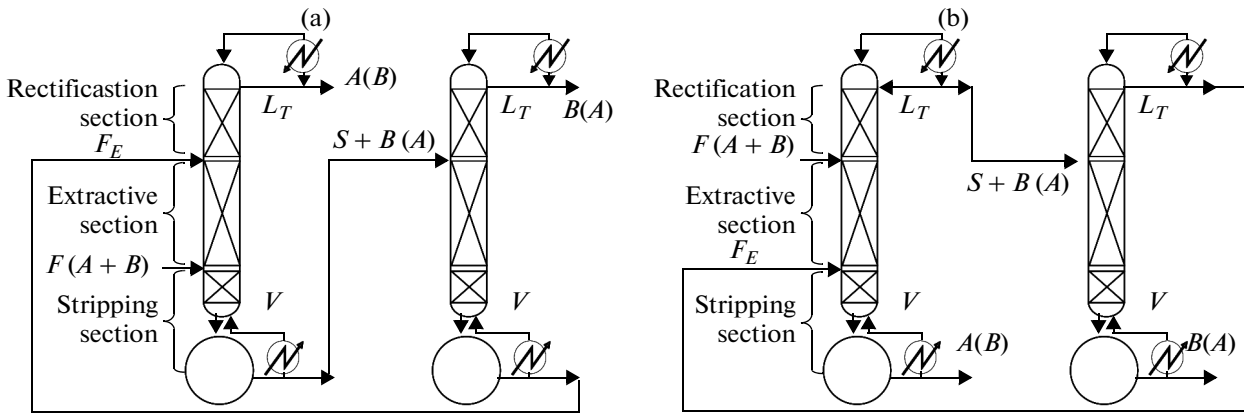

Fig. 5. Flowsheet of typical extractive distillation with (a) heavy entrainer, (b) light entrainer.

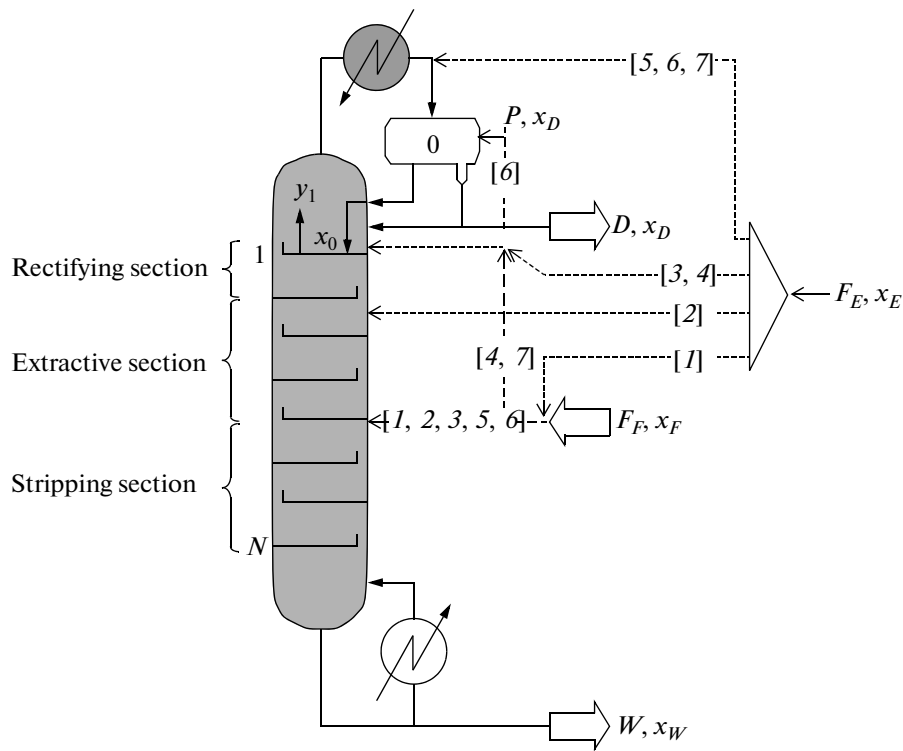

Fig. 6. Configurations for the heterogeneous extractive distillation column considering all possibilities for both the entrainer recycle and the main azeotropic feed.

increases as pressure decreases, possibly until disappearance of the azeotrope allowing the use of a conventional distillation process. In a ternary mixture separation, there may exist distillation boundaries involving azeotrope(s) as seen on residue curve maps. By changing the pressure we can cross these boundaries because they vary with pressure along with the azeotropic composition. Between the boundaries at two different pressures, there is a region from where different products can be obtained at the different pressures. If all products obtained at different pressures are pure components or pressure sensitive binary azeotrope(s)

this region is considered as the operating region of pressure swing distillation [56]. In pressure-swing distillation process, two columns operate at different pressures, each column supplied with the azeotropic composition at a pressure which is different from the other to obtain a possible pure component in each column. For the case of mixture with  $T_{\max}$  azeotrope, the less volatile component are obtained at first column top and more volatile one from the second column (Fig. 7). The opposite result occurs for the mixture with a  $T_{\min}$  azeotrope.

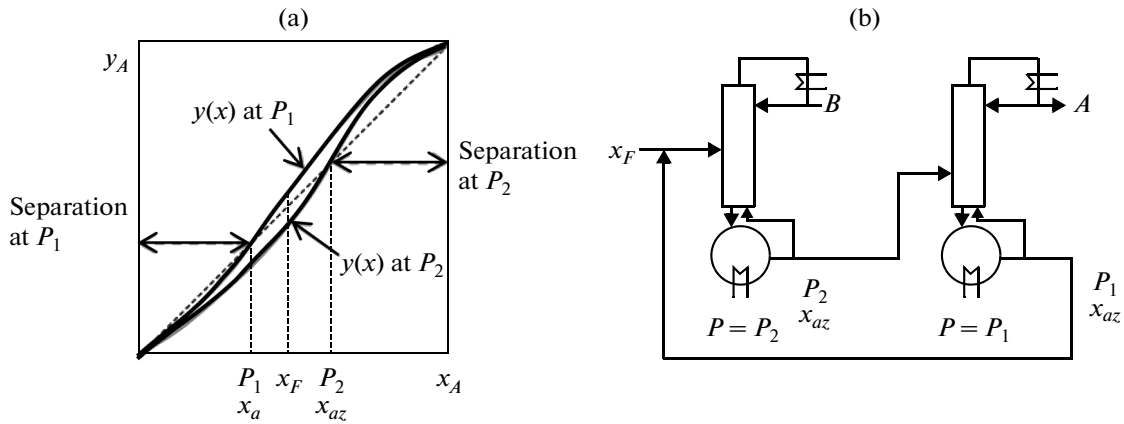

Fig. 7. (a) Effect of pressure on the azeotropic composition and (b) corresponding continuous pressure-swing distillation process.

Lewis [57] appears to be the first one to exploit the pressure sensibility to distillate azeotropic mixtures. Since then pressure-swing distillation has been known as a readily thermally integrated method to separate azeotropic mixtures. Thus pressure-insensitive binary azeotropes can be separated using novel entrainers that form pressure-sensitive distillation boundaries. The separations of ethanol from water and acetone from methanol were used to demonstrate the new pressure-swing technique. These examples exhibit some interesting behavior such as (1) a region of multiplicity in the number of trays required to achieve the same separation at fixed reflux ratio, (2) a maximum reflux ratio above which no feasible column exists, (3) a separation where the unexpected component is the distillate due to a reversal of the relative volatility as the pressure changes, and (4) a non-azeotropic separation that becomes easier as the pressure is increased. An optimal-control algorithm was employed to determine desirable campaigns, and to schedule pressure switch-over policies [48]. The column achieves production rates near 89% of the maximum throughput of a single column in the continuous process and shows superior performance when compared to reverse-batch operation. Based on the analysis of batch stripping/batch rectifying distillation regions, assuming maximal separation, Modla et al. [56] studied the feasibility of the separation of ternary homoazeotropic mixtures with pressure swing batch distillation (PSBD) in different column configurations: one column (batch stripper (BS) and rectifier (BR) and double column configurations (double column batch stripper (DCBS) and rectifier (DCBR)). The separation steps were also determined for the corresponding column configurations.

#### Strategies in Azeotropic Distillation

Azeotropic distillation usually refers to the specific technique of adding a third component along with the main feed. With an azeotropic mixture, the presence of entrainer results in the formation of more favorable

azeotropic pattern for the desired separation. Like in extractive distillation, in homoazeotropic distillation the added entrainer induce to alter the relative volatility of azeotropic mixture. The azeotropic distillation is used to separate AB azeotrope with entrainer E which may form homoazeotrope or heteroazeotrope with at least one component of original mixture. Homogeneous azeotropic distillation refers to a flowsheet structure in which azeotrope formation is exploited or avoided in order to accomplish the desired separation in one or more distillation columns. The structure of a particular sequence will depend on the geometry of the residue curve map or distillation region diagram for the feed mixture-entrainer system. For heteroazeotropic distillation, the two liquids formation provides a means of breaking azeotrope thus simplifying the entrainer recovery and recycle process.

Azeotropic processes have been well studied and the feasibility assessment only relies upon residue curve map analysis whereas for extractive distillation, the volatility order region must be known, as well. The separation of a minimum boiling azeotrope AB with entrainer E forming no new azeotrope is considered. Both A and B are stable node but they are located in different batch distillation regions. Residue curves begin at the unstable entrainer vertex (E) and end at the stable A or B. In batch both azeotropic components can be distilled if the boundary is curved enough [31, 58]. In continuous only A or B is obtained from the column, regarding continuous process, research has focused on advances in the methodologies for the synthesis, design, analysis and control of separation sequences involving homogeneous and heterogeneous azeotropic towers. Maps of residue curves and distillation lines were studied [59], as well as geometric methods for the synthesis and design of separation sequences, trends in the steady-state and dynamic analysis of homogeneous and heterogeneous towers, the nonlinear behavior of these towers, and strategies for their control. Emphasis is placed on the methods of computing all of the azeotropes associated

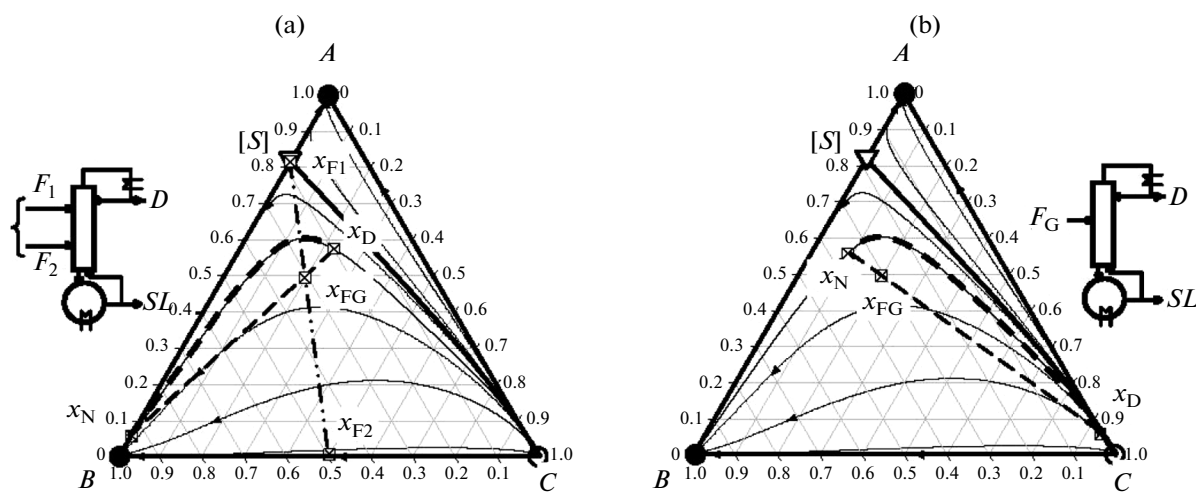

Fig. 8. Indirect separation (a) and direct (b) azeotropic continuous distillation.

with a multicomponent mixture, on the features that distinguish azeotropic distillations from their non azeotropic counterparts, on the possible steady-state multiplicity, and on the existence of maximum and minimum reflux ratio bounds. Important considerations in the selection of entrainers are examined [60]. For the synthesis of separation trains, when determining the feasible product compositions, the graphical methods are clarified, especially the conditions under which distillation boundaries can be crossed and bounding strategies under finite reflux ratio. Figure 8 shows the separation of an azeotropic ternary system belongs to the class Serafimov 1.0–2. Two distillation regions are separated by a separatrix connecting the saddle point azeotrope and unstable node entrainer in Fig. 8. The feeds  $F_1$  and  $F_2$  enter in different locations, and the composition of the global feed  $F_G$  is aligned with that of the column bottom  $SL$ , and the distillate  $D$ .  $x_D$  and  $x_N$  are connected by a composition profile which approximately follows the residue curve map. For indirect separation, the column bottom  $SL$  is located near the stable node  $B$  (Fig. 8a). For direct separation, the distillate  $D$  is located near the unstable node  $E$  (Fig. 8b).

#### Strategies in Reactive Distillation

Reactive distillation (RD) is a process where the chemical reactor is also the column. The entrainer reacts preferentially and reversibly with one of the original mixture components. The reaction product is distilled out from the non-reacting component and the reaction is reversed to recover the initial component. This can result insignificant reductions in both energy and equipment in systems that have appropriate chemistry and appropriate vapor-liquid phase equilibrium. This technique is attractive in those systems where certain chemical and phase equilibrium conditions exist and it is especially useful for equilib-

rium-limited reactions such as esterification and ester hydrolysis reactions. Conversion can be increased far beyond what is expected by the equilibrium due to the continuous removal of reaction products from the reactive zone [61]. This helps to reduce capital and investment costs and may be important for sustainable development since that shifts the chemical equilibrium to produce more products and thus a lower consumption of resource [62].

Although invented in 1921, the industrial application of reactive distillation did not take place before the 1980s. Being a relatively new field, research on various aspects such as modeling and simulation, process synthesis, column hardware design, non-linear dynamics and control is in progress [63, 64]. The suitability of RD for a particular reaction depends on various factors such as volatilities of reactants and products along with the feasible reaction and distillation temperature. Hence, the use of RD for every reaction may not be feasible. A commentary paper [65] on RD exposes an effective way of decomposing the design and development of reactive distillation involves four stages: (1) feasibility and alternatives; (2) conceptual design and evaluation; (3) equipment selection and hardware design; and (4) operability and control.

#### Strategies in Salt-Effect Distillation

The salt effect distillation is a method of extractive distillation in which a salt is dissolved in the mixture of liquids to be distilled. The salt dissociates in the mixture and alters the relative volatilities sufficiently so that the separation becomes possible. Hence salt effect on vapor-liquid equilibrium relationships provides a potential technique of extractive distillation for systems difficult or impossible to separate by normal rectification in a related process. The salt is fed into the distillation column at a steady rate by adding it to the reflux ratio stream at the top of the column. It dissolves

in the liquid phase, and since it is non-volatile, flows out with the heavier bottoms stream. The bottom is partially or completely evaporated to recover the salt for reuse. An example is the dehydration of ethanol using potassium acetate solution [66]. One advantage of salt-effect distillation over other types of azeotropic distillation is the potential for reduced costs associated with energy usage.

## CONCLUSIONS

In this communication, we have focused on reviewing the application of thermodynamic and non-conventional distillation strategies for azeotropic separation processes, including residue curve maps, univolatility and unidistribution curves studies on thermodynamic feasibility analysis, non-conventional distillation strategies covers pressure-swing distillation, azeotropic distillation, extractive distillation, reactive distillation and salt-effect distillation. The studies performed to date show a diverse field of research. It is evident that every technology will play a significant role in corresponding separation processes and has the potential to be, perhaps, a more sustainable technique than current comparable commercial technologies for separation.

Distillation is attractive separation method, comparison between different alternative separation methods for azeotropic mixtures show that extractive distillation is promising and challenging method of separation process and more advantageous than azeotropic distillation.

It should be noted that one of the significant factors in decision making for alternative technologies is the economical aspect. The novel proposed techniques or methods which are meant to replace the traditional processes should be economically feasible. However, there are very few detailed economic studies on these separation technologies. Hence, it is imperative that more studies of this nature are undertaken in near future to truly ascertain the sustainability of azeotropic separation technology.

## REFERENCES

1. Matsuyama, H. and Nishimura, H., Topological and thermodynamic classification of ternary vapor-liquid equilibria, *J. Chem. Eng. Jpn.*, 1977, vol. 10, no. 3, pp. 181-187.
2. Hilmen, E.K., Separation of azeotropic mixtures: Tools for analysis and studies on batch distillation operation, *PhD Thesis*, Norwegian Univ. of Science and Technology, 2000.
3. Hilmen, E.K. and Skogestad, S., Topology of ternary VLE diagrams: Elementary cells, *AIChE J.*, 2003, vol. 48, pp. 752-759.
4. Kiva, V., Hilmen, E.K., and Skogestad, S., Azeotropic phase equilibrium diagrams: A survey, *Chem. Eng. Sci.*, 2003, vol. 58, pp. 1903-1953.
5. Serafimov, L.A., Thermodynamic and topological analysis of liquid-vapor phase equilibrium diagrams and problems of rectification of multicomponent mixtures, in *Mathematical Methods in Contemporary Chemistry*, Kuchanov, S.I., Ed., New York: Gordon and Breach, 1996, ch. 10, pp. 557-603.
6. Luyben, W.L. and Chien, I.L., *Design and Control of Distillation Systems for Separating Azeotropes*, New York: Wiley, 2010.
7. Lang, P., Yatim, H., Moszkowicz, P., and Otterbein, M., Batch extractive distillation under constant reflux ratio, *Comput. Chem. Eng.*, 1994, vol. 18, pp. 1057-1069.
8. Rodriguez-Donis, I., Gerbaud, V., and Joulia, X., Thermodynamic insights on the feasibility of homogeneous batch extractive distillation: 1. Azeotropic mixtures with a heavy entrainer, *Ind. Eng. Chem. Res.*, 2009, vol. 48, pp. 3544-3559.
9. Shen, W.F., Benyounes, H., and Gerbaud, V., Extension of thermodynamic insights on batch extractive distillation to continuous operation: 1. Azeotropic mixtures with a heavy entrainer, *Ind. Eng. Chem. Res.*, 2013, vol. 52, pp. 4606-4622.
10. Benyounes, H., Shen, W.F., and Gerbaud, V., Entropy flow and energy efficiency analysis of extractive distillation with a heavy entrainer, *Ind. Eng. Chem. Res.*, 2014, vol. 53, no. 12, pp. 4778-4791.
11. Benyahia, K., Benyounes, H., and Shen, W.F., Energy evaluation of ethanol dehydration with glycol mixture as entrainer, *Chem. Eng. Technol.*, 2014, vol. 37, no. 6, pp. 987-994.
12. Lelkes, Z., Rev, E., Steger, C., and Fonyo, Z., Batch extractive distillation of maximal azeotrope with middle boiling entrainer, *AIChE J.*, 2002, vol. 48, pp. 2524-2536.
13. Lang, P., Lelkes, Z., Otterbein, M., Benadda, B., and Modla, G., Feasibility studies for batch extractive distillation with a light entrainer, *Comput. Chem. Eng.*, 1999, vol. 23, pp. 93-96.
14. Rodriguez-Donis, I., Gerbaud, V., and Joulia, X., Thermodynamic insights on the feasibility of homogeneous batch extractive distillation: 3. Azeotropic mixtures with light entrainer, *Ind. Eng. Chem. Res.*, 2012, vol. 51, pp. 4643-4660.
15. Shen, W.F. and Gerbaud, V., Extension of thermodynamic insights on batch extractive distillation to continuous operation: 2. Azeotropic mixtures with a light entrainer, *Ind. Eng. Chem. Res.*, 2013, vol. 52, pp. 4623-4637.
16. Laroche, L., Bekiaris, N., Andersen, H.W., and Morari, M., The curious behavior of homogeneous azeotropic distillation—implications for entrainer selection, *AIChE J.*, 1992, vol. 38, pp. 1309-1328.
17. Yatim, H., Moszkowicz, P., Otterbein, M., and Lang, P., Dynamic simulation of a batch extractive distillation process, *Comput. Chem. Eng.*, 1993, vol. 17, pp. 57-62.
18. Lang, P., Yatim, H., Moszkowicz, P., and Otterbein, M., Batch extractive distillation under constant reflux ratio, *Comput. Chem. Eng.*, 1994, vol. 18, pp. 1057-1069.
19. Knapp, J.P. and Doherty, M.F., Minimum entrainer flows for extractive distillation: A bifurcation theoretic approach, *AIChE J.*, 1994, vol. 40, pp. 243-268.

20. Lelkes, Z., Lang, P., Benadda, B., and Moszkowicz, P., Feasibility of extractive distillation in a batch rectifier, *AIChE J.*, 1998, vol. 44, pp. 810–822.
21. Lelkes, Z., Lang, P., Moszkowicz, P., Benadda, B., and Otterbein, M., Batch extractive distillation: The process and the operational policies, *Chem. Eng. Sci.*, 1998, vol. 53, pp. 1331–1348.
22. Brüggemann, S. and Marquardt, W., Shortcut methods for nonideal multicomponent distillation: 3. Extractive distillation columns, *AIChE J.*, 2004, vol. 50, no. 6, pp. 1129–1149.
23. Luyben, W.L., Effect of solvent on controllability in extractive distillation, *Ind. Eng. Chem. Res.*, 2008, vol. 47, pp. 4425–4439.
24. Luyben, W.L., Comparison of extractive distillation and pressure-swing distillation for acetone–methanol separation, *Ind. Eng. Chem. Res.*, 2008, vol. 47, pp. 2696–2707.
25. Lang, P., Modla, G., Benadda, B., and Lelkes, Z., Homoazeotropic distillation of maximum azeotrope in a batch rectifier with continuous entrainer feeding: 1. Feasibility studies, *Comput. Chem. Eng.*, 2000, vol. 24, pp. 1665–1671.
26. Lang, P., Modla, G., Kotai, B., Lelkes, Z., and Moszkowicz, P., Homoazeotropic distillation of maximum azeotropes in a batch rectifier with continuous entrainer feeding: 2. Rigorous simulation results, *Comput. Chem. Eng.*, 2000, vol. 24, pp. 1429–1435.
27. Rodriguez-Donis, I., Gerbaud, V., and Joulia, X., Thermodynamic insights on the feasibility of homogeneous batch extractive distillation: 2. Low-relative-volatility binary mixtures with a heavy entrainer, *Ind. Eng. Chem. Res.*, 2009, vol. 4, pp. 3560–3572.
28. Rév, E., Lelkes, Z., Varga, V., Stéger, C., and Fonyo, Z., Separation of a minimum boiling azeotrope in a batch extractive rectifier with an intermediate boiling entrainer, *Ind. Eng. Chem. Res.*, 2003, vol. 42, pp. 162–174.
29. Varga, V., Rév, E., Gerbaud, V., Fonyo, Z., and Joulia, X., Batch extractive distillation with light entrainer, *Chem. Biochem. Eng.*, 2006, vol. 20, pp. 1–23.
30. Rodriguez-Donis, I., Gerbaud, V., and Joulia, X., Thermodynamic insights on the feasibility of homogeneous. Batch extractive distillation: 4. Azeotropic mixtures with intermediate boiling entrainer, *Ind. Eng. Chem. Res.*, 2012, vol. 51, pp. 6489–6501.
31. Bernot, C., Doherty, M.F., and Malone, M.F., Patterns of composition change in multicomponent batch distillation, *Chem. Eng. Sci.*, 1990, vol. 45, pp. 1207–1221.
32. Medvedev, D.V. and Serafimov, L.A., Residue curve map synthesis applied to four-component systems: The boundary space of the diagram, *Theor. Found. Chem. Eng.*, 2011, vol. 45, no. 4, pp. 420–428.
33. Serafimov, L.A., The azeotropic rule and the classification of multicomponent mixtures: VII. Diagrams for ternary systems mixtures, *Russ. J. Phys. Chem.*, 1970, vol. 44, pp. 567–571.
34. Serafimov, L.A., The azeotropic rule and the classification of multicomponent mixtures: XI. Tangential azeotropy for three-component systems and chains of topological structures, *Russ. J. Phys. Chem.*, 1971, vol. 45, no. 10, pp. 1388–1389.
35. Serafimov, L.A., Frolkova, A.K., and Chelyuskina, T.V., Selecting extracting agents for separation of biazeotropic binary mixtures by extractive distillation, *Theor. Found. Chem. Eng.*, 2009, vol. 43, no. 6, pp. 889–898.
36. Petlyuk, F.B., Kievskii, V.Y., and Serafimov, L.A., Determination of product compositions for polyazeotropic mixtures distillation, *Theor. Found. Chem. Eng.*, 1979, vol. 13, pp. 643–649.
37. Balashov, M.L., Grishunin, V.A., and Serafimov, L.A., Regions of continuous rectification in systems divided into distillation regions, *Theor. Found. Chem. Eng.*, 1984, vol. 18, pp. 427–433.
38. Balashov, M.L. and Serafimov, L.A., Investigation of rules governing the formation of regions of continuous rectification, *Theor. Found. Chem. Eng.*, 1984, vol. 18, pp. 360–366.
39. Petlyuk, F.B., Danilov, R.Y., and Serafimov, L.A., Feasible variants of separation in distillation of multicomponent azeotropic mixtures, *Theor. Found. Chem. Eng.*, 2009, vol. 43, no. 1, pp. 23–32.
40. Petlyuk, F.B., *Distillation Theory and Its Application to Optimal Design of Separation Units*, Cambridge: Cambridge Univ., 2004.
41. Raeva, V.M., Sazonova, A.Y., and Frolkova, A.K., Synergetic effect of binary separating agents in extractive rectification of homogeneous mixtures, *Theor. Found. Chem. Eng.*, 2013, vol. 47, no. 5, pp. 649–659.
42. Benyounes, H. and Frolkova, A.K., Aspects of multicomponent mixture separation in the presence of selective solvents, *Chem. Eng. Commun.*, 2010, vol. 197, no. 7, pp. 901–918.
43. Frolkova, A.K. and Raeva, V.M., Bioethanol dehydration: State of the art, *Theor. Found. Chem. Eng.*, 2010, vol. 44, no. 4, pp. 545–556.
44. Stéger, C., Varga, V., Horvath, L., Rév, E., Fonyo, Z., Meyer, M., and Lelkes, Z., Feasibility of extractive distillation process variants in batch rectifier column, *Chem. Eng. Process.*, 2005, vol. 44, pp. 1237–1256.
45. Rodriguez-Donis, I., Gerbaud, V., and Joulia, X., Thermodynamic insights on the feasibility of homogeneous batch extractive distillation: 3. Azeotropic mixtures with light entrainer, *Ind. Eng. Chem. Res.*, 2012, vol. 51, pp. 4643–4660.
46. Rodriguez-Donis, I., Papp, K., Rév, E., Lelkes, Z., Gerbaud, V., and Joulia, X., Column configurations of continuous heterogeneous extractive distillation, *AIChE J.*, 2007, vol. 53, pp. 1982–1993.
47. Demicoli, D. and Stichlmair, J., Novel operational strategy for the separation of ternary mixtures via cyclic operation of a batch distillation column with side withdrawal, *Comput. Aided Chem. Eng.*, 2003, vol. 14, pp. 629–634.
48. Phimister, J.R. and Seider, W.D., Semicontinuous, pressure-swing distillation, *Ind. Eng. Chem. Res.*, 2000, vol. 39, pp. 122–130.
49. Stéger, C., Varga, V., Horvath, L., Rév, E., Fonyo, Z., Meyer, M., and Lelkes, Z., Feasibility of extractive distillation process variants in batch rectifier column, *Chem. Eng. Process.*, 2005, vol. 44, pp. 1237–1256.
50. Pham, H.N. and Doherty, M.F., Design and synthesis of heterogeneous azeotropic distillations—II. Residue

- curve maps, *Chem. Eng. Sci.*, 1990, vol. 45, pp. 1837–1843.
51. Ulrich, J. and Morari, M., Operation of homogeneous azeotropic distillation column sequences, *Ind. Eng. Chem. Res.*, 2003, vol. 42, pp. 4512–4534.
  52. Thomas, B. and Karl, HansS., Knowledge integrating system for the selection of solvents for extractive and azeotropic distillation, *Comput. Chem. Eng.*, 1994, vol. 18, no. 1, pp. 25–29.
  53. Levy, S.G. and Doherty, M.F., Design and synthesis of homogeneous azeotropic distillations: 4. Minimum reflux ratio calculations for multiple-feed columns, *Ind. Eng. Chem. Fund.*, 1986, vol. 25, pp. 269–279.
  54. Frits, E.R., Lelkes, Z., Fonyó, Z., Rév, E., Markót, M.C., and Csendes, T., Finding limiting flows of batch extractive distillation with interval arithmetic, *AIChE J.*, 2006, vol. 52, pp. 3100–3108.
  55. Seader, J.D. and Henley, E.J., *Separation Process Principles*, New York: Wiley, 1998.
  56. Modla, G., Pressure swing batch distillation by double column systems in closed mode, *Comput. Chem. Eng.*, 2010, vol. 34, pp. 1640–1654.
  57. Lewis, G.N. and Cornish, R.E., Separation of the isotopic forms of water by fractional distillation, *J. Am. Chem. Soc.*, 1933, vol. 55, pp. 2616–2617.
  58. Doherty, M.F. and Malone, M.F., *Conceptual Design of Distillation Systems*, New York: McGraw-Hill, 2001.
  59. Widagdo, S. and Seider, W.D., Azeotropic distillation, *AIChE J.*, 1996, vol. 42, pp. 96–146.
  60. Foucher, E.R., Doherty, M.F., and Malone, M.F., Automatic screening of entrainers for homogeneous azeotropic distillation, *Ind. Eng. Chem. Res.*, 1991, vol. 30, pp. 760–772.
  61. Pisarenko, Yu.A., Epifanova, O.A., and Serafimov, L.A., Conditions for a steady state in a reactive distillation operation, *Theor. Found. Chem. Eng.*, 1988, vol. 22, no. 1, pp. 31–34.
  62. Luyben, W.L. and Yu, C.C., *Reactive Distillation Design and Control*, Wiley, 2009.
  63. Balashov, M. and Serafimov, L.A., Principles and technological methods for the continuous design of combination of reaction rectification processes, *Theor. Found. Chem. Eng.*, 1980, vol. 14, no. 5, p. 332.
  64. Pisarenko, Yu.A., Epifanova, O.A., and Serafimov, L.A., Dynamics of continuous evaporation with a chemical reaction, *Theor. Found. Chem. Eng.*, 1989, vol. 22, no. 6, pp. 483–488.
  65. Malone, M.F. and Doherty, M.F., Reactive distillation, *Ind. Eng. Chem. Res.*, 2000, vol. 39, pp. 3953–3957.
  66. Furter, W.F., Extractive distillation by salt effect, *Chem. Eng. Commun.*, 1992, vol. 116, no. 1, pp. 35–40.