



HAL
open science

Closed-form solutions to optimal parameters of dynamic vibration absorbers with negative stiffness under harmonic and transient excitation

Shaoyi Zhou, Claire Jean-Mistral, Simon Chesné

► To cite this version:

Shaoyi Zhou, Claire Jean-Mistral, Simon Chesné. Closed-form solutions to optimal parameters of dynamic vibration absorbers with negative stiffness under harmonic and transient excitation. International Journal of Mechanical Sciences, 2019, 157-158, pp.528-541. 10.1016/j.ijmecsci.2019.05.005 . hal-02132431

HAL Id: hal-02132431

<https://hal.science/hal-02132431>

Submitted on 22 Oct 2021

HAL is a multi-disciplinary open access archive for the deposit and dissemination of scientific research documents, whether they are published or not. The documents may come from teaching and research institutions in France or abroad, or from public or private research centers.

L'archive ouverte pluridisciplinaire **HAL**, est destinée au dépôt et à la diffusion de documents scientifiques de niveau recherche, publiés ou non, émanant des établissements d'enseignement et de recherche français ou étrangers, des laboratoires publics ou privés.



Distributed under a Creative Commons Attribution - NonCommercial 4.0 International License

Closed-form solutions to optimal parameters of dynamic vibration absorbers with negative stiffness under harmonic and transient excitation

Shaoyi Zhou, Claire Jean-Mistral, Simon Chesne*

Université de Lyon, CNRS INSA-Lyon, LaMCoS UMR5259, 69621 Villeurbanne, France

Abstract

In this present paper, two configurations of dynamic vibration absorber in conjunction with negative stiffness (NSDVA) are investigated and their parameter optimization is conducted according to two tuning methodologies: the fixed points theory and the stability maximization criterion. Closed-form solutions to the optimal parameters of NSDVAs are analytically derived and are expressed in terms of ratio between the negative stiffness and mechanical stiffness of primary system. Allowable bounds on negative stiffness are specified with the consideration of stability requirement, based on which the ultimate control performance of NSDVAs could be imagined. Furthermore, an optimal negative stiffness ratio is defined within the stable region when the NSDVAs are tuned by the fixed points theory. Finally, numerical simulations are carried out in both harmonic and free vibration scenarios. Simulation results suggest that the inclusion of negative stiffness in the coupled system can significantly improve the vibration control performance in terms of broadening the frequency bandwidth of vibration suppression, decreasing the peak vibration amplitude of primary system and confining the stroke length of NSDVAs. Meanwhile, the negative stiffness can enhance the damping capability of coupled system, engendering an accelerated convergence of transient disturbances.

Keywords: Dynamic vibration absorber, negative stiffness, optimization, fixed points theory, stability maximization criterion

1. Introduction

In the fields of mechanical and civil engineering, the dynamic vibration absorber (DVA) is widely used to reduce the undesired detrimental effects of dynamic loads on primary systems for its high simplicity and reliability [1–4]. Conventional DVAs are purely passive and are composed of three common mechanical elements, i.e. mass, spring and viscous damper. The traditional DVA (denoted as DVA-I in this paper) was proposed and well documented in [5], whose mass is attached to the primary structure via a parallel connection of a linear spring and damper. Meanwhile, a non-traditional DVA (denoted as DVA-II) was developed in [6], whose damper is connected to the base instead of the main system.

The first analytical method for tuning DVAs is the fixed points theory [5]. In the objective of minimizing the peak amplitude of frequency response function (FRF) of primary system, it consists in equalizing the vibration amplitude at fixed points and making the FRF passing horizontally through these points. In fact, the fixed points correspond to positions where all FRFs of undamped primary system intersect, regardless of the damping level of DVA. Clearly, this heuristic approach only yields an approximate solution to the H_∞

*Corresponding author
Email address: simon.chesne@insa-lyon.fr (Simon Chesne)

14 optimization problem due to the discrepancy between fixed points and resonance peaks of FRF, however, its
15 high accuracy and efficiency is a long established fact [7]. By applying the fixed points theory, the optimal
16 tuning of DVA-I and DVA-II was accomplished by Den Hartog [5] and Ren [6], respectively, when connecting
17 to an undamped primary system of single degree of freedom (SDOF). It was reported in [6] that compared to
18 DVA-I, DVA-II can slightly improve the vibration control performance and could bring convenience in certain
19 practical implementation. For damped primary systems, approximate solutions were carried out for optimal
20 parameters of DVA-I [8] and DVA-II [9] by employing an equivalent linearisation technique, by means of which
21 the damped primary system can be matched with an equivalent undamped one.

22 When the main system undergoes a transient disturbance, however, the optimal tuning based on fixed
23 points theory could loss its effectiveness, since it aims at improving the steady state frequency response. In
24 this context, a new tuning rule, termed as stability maximization criterion, was proposed by Yamaguchi [10]
25 in the objective of decaying the transient disturbance as soon as possible. The design objective is fulfilled
26 by maximizing the minimal absolute value of the real parts of system eigenvalues. By using this method,
27 Yamaguchi [10] determined the optimal parameters for a DVA-I attached to an undamped primary structure.
28 Xiang and Nishitani [11] analytically formulated the optimal parameters of DVA-II for an undamped main
29 system, meanwhile, provided numerical solutions for a main system with different damping values.

30 Nevertheless, the disadvantages of DVA-I and DVA-II are evident. First, their vibration control performance
31 is limited by the maximally attainable mass ratio between the DVA and main system. Second, both DVAs are
32 only effective within a narrow frequency range around the target mode, whose control effect could deteriorate
33 when the excitation frequency varies. In the objective of enabling DVAs to adaptively track the excitation
34 frequency, smart materials whose physical properties are adjustable can be integrated, e.g. shape memory alloy
35 [12, 13], magnetorheological elastomer [14, 15] and combination thereof [16]. Besides, it was reported in [17]
36 that the negative stiffness can be used to enhance the vibration control performance.

37 The negative stiffness mechanism (NSM) is featured by a force-displacement curve with a negative slope,
38 signifying that a NSM can generate a force to assist its motion instead of resisting it. Recently, the NSM has
39 received wide attention in the domain of vibration isolation. By arranging in parallel the NSM and the support
40 stiffness of structure to be isolated, the resonance frequency can be decreased, thereby improving the vibration
41 isolation in the low-frequency region and broadening the frequency range of vibration isolation, meanwhile,
42 the static stiffness is not affected in avoidance of an excessive static deflection and system instability. The
43 high-static-low-dynamic stiffness characteristics can be achieved by various mechanical structures, which can
44 be categorized into: symmetric pre-compressed springs [18, 19], bio-inspired X-shaped structures [20, 21] and
45 magnetic negative stiffness springs [22, 23]. Clearly, most NSMs in aforementioned researches are passive and
46 nonlinear, meanwhile, it was stated in [23] that the negative stiffness utilizing Maxwell magnetic normal stress
47 can be regarded as linear in a certain range around the equilibrium position. A more convenient approach to
48 realize a linear NSM was proposed and experimentally validated in [24] by using an active control technique
49 with a linear actuator. To summarize, the NSM has widespread application in ameliorating the vibration
50 isolation performance, however, only few studies on enhancing the control effect of DVAs via negative stiffness
51 are available in the literature, as reported below.

52 Shen et al. [25] incorporated a negative stiffness between the base and the mass of DVA-II, yielding the
53 NSDVA-II configuration. Its optimization according to the fixed points theory was carried out for a SDOF
54 primary system, suggesting that the use of negative stiffness decreases the peak vibration amplitude of primary

55 system and broadens the frequency range of vibration absorption. Similarly, the NSDVA-I was studied by
56 Antoniadis et al. [26], however, the optimal damping value of absorber had not been provided. Later, Huang et
57 al. [27] also addressed the optimal tuning of NSDVA-I attached to a SDOF primary system, while the optimal
58 damping value of absorber was derived according to the equal damping criterion proposed in [28]. This criterion
59 yielded a larger damping value for DVA and a larger peak amplitude for primary system when compared to
60 the case optimized by the fixed points theory. It should be mentioned that the intentional introduction of a
61 grounded negative stiffness into both DVAs does contribute to the improvement of vibration control performance,
62 meanwhile, the coupled system could be potentially destabilized. Nevertheless, the crucial stability analysis and
63 the permissible interval of negative stiffness had not been addressed in aforesaid works and the NSDVAs had
64 been optimized only in terms of suppressing harmonic vibration.

65 Therefore, the focus of this present paper is to carry out a thorough optimization analysis for both types
66 of DVAs enhanced by grounded negative stiffness, NSDVA-I and NSDVA-II, under harmonic and transient
67 excitation circumstances. Coupled systems related to both NSDVA-I and NSDVA-II are nondimensionalized in
68 the same framework. Then, their optimal parameters are determined based on the two aforementioned tuning
69 strategies, fixed points theory (FPT) and stability maximization criterion (SMC), respectively. And light will
70 be shed onto the influence of negative stiffness on the control performance of DVAs and the allowable bounds
71 on negative stiffness will be also predicted for both types of NSDVAs relevant to each optimization criterion.
72 Finally, NSDVA-I and NSDVA-II will be compared with each other in different excitation scenarios for the first
73 time.

74 This paper is organized as follows. In the next section, mathematical modeling of both NSDVA-I and
75 NSDVA-II implementing on a SDOF primary system is first presented and a stability analysis is performed. In
76 Sections 3 and 4, the optimal parameters of NSDVAs are analytically derived according to two aforementioned
77 criteria, respectively. Finally, simulation results and numerical analyses are given in Section 5 in order to
78 underline the effect of negative stiffness and to compare the control performance of different DVAs.

79 2. Mathematical modeling

80 2.1. NSDVA-I

81 A SDOF undamped primary system attached with a DVA-I is presented in Fig. 1a and Fig. 1b illustrates
82 the coupled system with NSDVA-I, which is based on the classic DVA with a supplementary negative element
83 locating between the secondary mass and the base. With an excitation force $F(t)$ exerted on the primary
84 system, the dynamics of the two DOF system in Fig. 1b can be described by the equations of motion:

$$m_1\ddot{x}_1 = k_2(x_2 - x_1) + c_2(\dot{x}_2 - \dot{x}_1) - k_1x_1 + F(t) \quad (1a)$$

$$m_2\ddot{x}_2 = k_2(x_1 - x_2) + c_2(\dot{x}_1 - \dot{x}_2) - k_nx_2 \quad (1b)$$

85 where x_1 and x_2 are the displacements of the main and secondary mass, respectively, and the dot represents
86 differentiation with respect to the actual time t . m_1 and k_1 are the mass and mechanical stiffness of the primary
87 system. m_2 , c_2 and k_2 stand for the mass, viscous damping coefficient and mechanical stiffness of the DVA. k_n
88 denotes the grounded negative stiffness.

89 Denoted by ω_1 , ω_2 and ξ , the natural frequencies of the main system and of the DVA and the mechanical

90 damping ratio of DVA are expressed by, respectively:

$$\omega_1 = \sqrt{\frac{k_1}{m_1}}, \quad \omega_2 = \sqrt{\frac{k_2}{m_2}}, \quad \xi = \frac{c_2}{2\sqrt{k_2 m_2}}. \quad (2)$$

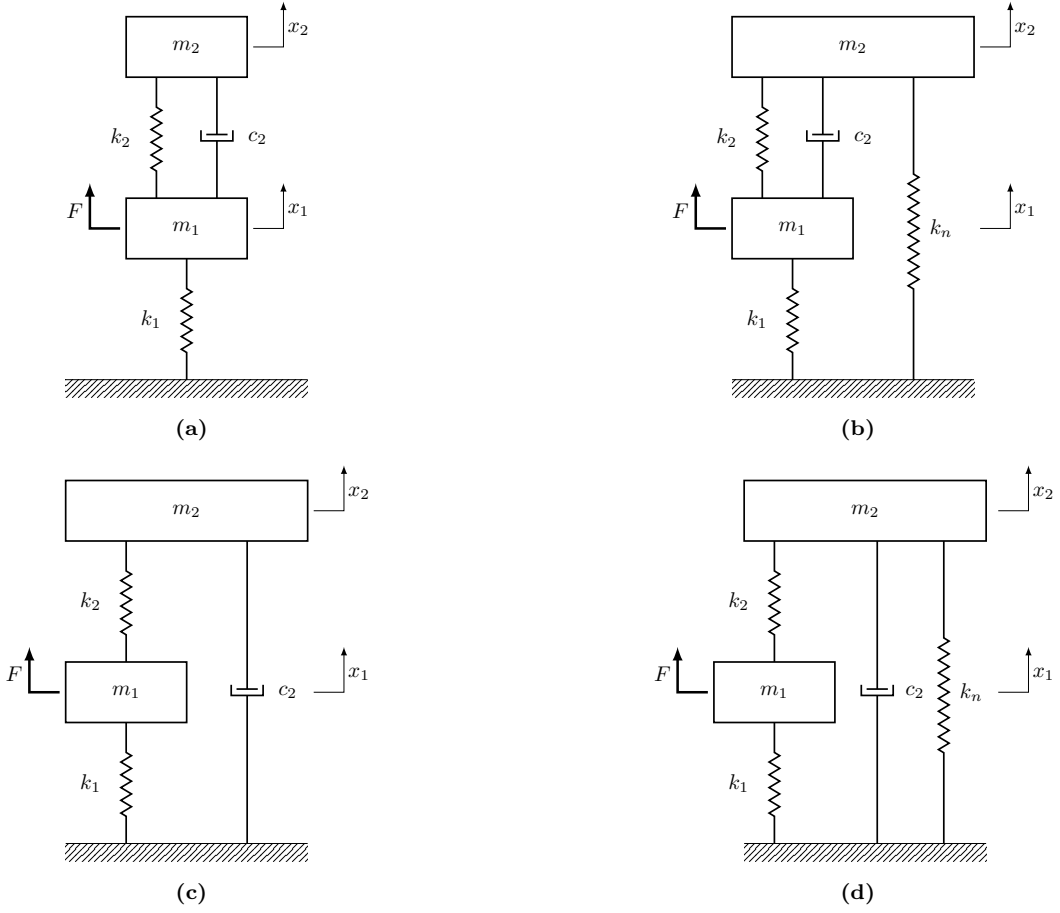

Fig. 1. Schematic diagrams of a SDOF undamped primary system controlled by four types of absorber under direct force excitation: (a) DVA-I; (b) NSDVA-I; (c) DVA-II; (d) NSDVA-II.

91 Then, two common tuning parameters of DVAs, the mass ratio μ and the frequency tuning ratio f between
92 secondary and primary systems, can be defined as:

$$\mu = \frac{m_2}{m_1}, \quad f = \frac{\omega_2}{\omega_1}. \quad (3)$$

93 Furthermore, an additional dimensionless parameter β is herein introduced, which is defined as the ratio of
94 negative stiffness and the mechanical stiffness of primary system:

$$\beta = \frac{k_n}{k_1} \quad (4)$$

95 with $\beta \leq 0$. Rescaling the time by $t = \tau/\omega_1$, one has:

$$\frac{d}{dt} = \omega_1 \frac{d}{d\tau}, \quad \frac{d^2}{dt^2} = \omega_1^2 \frac{d^2}{d\tau^2}. \quad (5)$$

96 By substituting Eqs. (2)-(5) into Eq. (1), the equations of motion (1) reduce to

$$x_1'' + x_1 + \mu x_2'' + \beta x_2 = F(\tau)/k_1 \quad (6a)$$

$$x_2'' + 2\xi f(x_2' - x_1') + f^2(x_2 - x_1) + \frac{\beta}{\mu} x_2 = 0 \quad (6b)$$

97 where the prime in the superscript indicates differentiation with respect to the rescaled time τ . The dimensionless
 98 frequency variable, complex magnitudes of displacement x_1 and external force $F(\tau)$ are denoted by \bar{s} , X_1 and
 99 F , respectively. The transfer function $G_I(\bar{s})$ relating the static displacement of primary system, F/k_1 , and the
 100 displacement of primary system, X_1 , can be obtained by transforming Eq. (6) in the Laplace domain:

$$G_I(\bar{s}) = \frac{X_1}{F/k_1} = \frac{\mu\bar{s}^2 + 2\mu\xi f\bar{s} + \beta + \mu f^2}{\mu\bar{s}^4 + 2\mu\xi f(1 + \mu)\bar{s}^3 + (\beta + \mu + \mu f^2 + \mu^2 f^2)\bar{s}^2 + 2\mu\xi f(1 + \beta)\bar{s} + \beta + \mu f^2(1 + \beta)} \quad (7)$$

101 where F/k_1 corresponds to the static deformation amplitude of primary system when controlled by a classic
 102 DVA, namely $\beta = 0$. It is worth noting that as a negative stiffness is present, the static displacement of primary
 103 system is no longer equal to F/k_1 , as evident from $G_I(\bar{s} = 0) \neq 1$.

104 2.2. NSDVA-II

105 Fig. 1c illustrates the undamped primary system controlled by a non-traditional DVA, and Fig. 1d represents the
 106 coupled system relevant to NSDVA-II. Similarly, the dynamics of coupled system in Fig. 1d can be formulated
 107 as:

$$m_1\ddot{x}_1 = k_2(x_2 - x_1) - k_1x_1 + F(t) \quad (8a)$$

$$m_2\ddot{x}_2 = k_2(x_1 - x_2) - k_nx_2 - c_2\dot{x}_2 \quad (8b)$$

108 By taking the same procedure as in subsection 2.1, Eq. (8) can be recast into a dimensionless form:

$$x_1'' + (1 + \mu f^2)x_1 - \mu f^2 x_2 = F(\tau)/k_1 \quad (9a)$$

$$x_2'' + 2\xi f x_2' + f^2(x_2 - x_1) + \frac{\beta}{\mu}x_2 = 0 \quad (9b)$$

109 In this scenario, the transfer function $G_{II}(\bar{s})$ from the static displacement of primary system, F/k_1 , to the
 110 displacement of primary system, X_1 , is described by:

$$G_{II}(\bar{s}) = \frac{X_1}{F/k_1} = \frac{\mu\bar{s}^2 + 2\mu\xi f\bar{s} + \beta + \mu f^2}{\mu\bar{s}^4 + 2\mu\xi f\bar{s}^3 + (\beta + \mu + \mu f^2 + \mu^2 f^2)\bar{s}^2 + 2\mu\xi f(1 + \mu f^2)\bar{s} + \beta + \mu f^2(1 + \beta)} \quad (10)$$

111 It is apparent that the transfer function of coupled system without negative stiffness can be achieved by vanishing
 112 β in Eq. (7) or (10). Moreover, the primary system coupled with either a NSDVA-I or a NSDVA-II has the
 113 same expression of static displacement, as $G_I(\bar{s} = 0) = G_{II}(\bar{s} = 0)$.

114 2.3. Stability analysis

115 In light of the inclusion of negative stiffness, it is of a special importance to specify the allowable bound on the
 116 value of negative stiffness, within which the coupled system remains stable. Considering that stability analysis
 117 of such kind of system is rare in the current literature, therefore, one of the major contribution of this present
 118 paper is to conduct a systematic study on stability issue of primary system coupled with different types of
 119 NSDVA and in the two aforementioned excitation scenarios.

120 According the Routh-Hurwitz stability criterion, a system is asymptotically stable if and only if all its
 121 eigenvalues lie in the left half of the complex plane. Denoted by λ , eigenvalues can be determined by the
 122 characteristic polynomial $P(\lambda)$ of the two DOF system in the form of:

$$P(\lambda) = \lambda^4 + \delta_1\lambda^3 + \delta_2\lambda^2 + \delta_3\lambda + \delta_4 \quad (11)$$

123 and the stability of coupled system is guaranteed when the following necessary and sufficient conditions are
 124 satisfied:

$$\delta_1 > 0, \quad \delta_3 > 0, \quad \delta_4 > 0, \quad \delta_1 \delta_2 \delta_3 > \delta_3^2 + \delta_1^2 \delta_4. \quad (12)$$

125 where all real coefficients of the characteristic polynomial $P(\lambda)$ correspond to the ones in the denominator of
 126 the transfer function, $G_I(\bar{s})$ or $G_{II}(\bar{s})$, recasting into the monic form. Therefore, these coefficients are given by

127 • NSDVA-I:

$$\delta_1 = 2\xi f(1 + \mu), \quad \delta_2 = 1 + \frac{\beta}{\mu} + (1 + \mu)f^2, \quad \delta_3 = 2\xi f(1 + \beta), \quad \delta_4 = \frac{\beta}{\mu} + (1 + \beta)f^2. \quad (13)$$

128 • NSDVA-II:

$$\delta_1 = 2\xi f, \quad \delta_2 = 1 + \frac{\beta}{\mu} + (1 + \mu)f^2, \quad \delta_3 = 2\xi f(1 + \mu f^2), \quad \delta_4 = \frac{\beta}{\mu} + (1 + \beta)f^2. \quad (14)$$

129 By substituting Eq. (13) or (14) into Eq. (12), a unique constraint on the negative stiffness ratio β for both
 130 types of NSDVAs can be achieved as follows:

$$\beta > -\frac{\mu f^2}{\mu f^2 + 1} = -1 + \frac{1}{\mu f^2 + 1} \quad (15)$$

131 where the expression of lower bound on β is implicit due to the probable dependence between the frequency
 132 tuning ratio f and the negative stiffness ratio β . Nevertheless, it is evident from Eq. (15) that β should be
 133 always greater than -1 for any positive mass ratio μ , signifying that the absolute value of negative stiffness
 134 k_n should be always inferior to that of primary system k_1 . The explicit expression for lower limit of β will be
 135 derived in the following study under the condition that the analytical formulation of frequency tuning ratio f
 136 is sought and expressed as a function of β .

137 3. Optimization of NSDVA-I

138 In this section, the primary system undergoes a sinusoidal or transient disturbance and the parameters of
 139 NSDVA-I are tuned successively by the FPT and SMC. Moreover, the permissible bound on β will be specified
 140 in each scenario and an optimal value of β will be also defined in the harmonic case.

141 3.1. Harmonic excitation scenario

142 Considering that the primary system is harmonically excited at the forcing frequency ω , its squared amplitude
 143 of FRF can be written by substituting $\bar{s} = j\omega/\omega_1 = j\alpha$ into Eq. (7):

$$G_I^2(\Omega) = \left| \frac{X_1}{F/k_1} \right|^2 = \frac{A + 4\xi^2 B}{C + 4\xi^2 D} \quad (16)$$

144 with $j = \sqrt{-1}$ and α designating the excitation frequency normalized by the natural frequency of primary system.
 145 And the four components are given by:

$$\begin{aligned} A &= [\beta + \mu(\phi - \Omega)]^2, & B &= \mu^2 \phi \Omega, \\ C &= [[\beta + \mu(\phi - \Omega)](1 - \Omega) + \mu\phi(\beta - \mu\Omega)]^2, & D &= \mu^2 \phi \Omega(1 - \Omega + \beta - \mu\Omega)^2. \end{aligned} \quad (17)$$

146 where two intermediate parameters are introduced for the purpose of brevity, i.e.:

$$\phi = f^2, \quad \Omega = \alpha^2. \quad (18)$$

147 3.1.1. Optimal tuning based on fixed points theory

148 Fig. 2 depicts several normalized frequency responses of primary system coupled with a NSDVA-I with different
 149 damping ratios. One can tell that there exist two fixed points, denoted by P and Q , whose abscissas are
 150 independent of the mechanical damping ratio ξ . In order to locate their abscissas, two extreme scenarios are
 151 considered, $\xi = 0$ and $\xi \rightarrow \infty$, where the squared amplitudes of FRF can be simplified as:

$$G_I^2 \Big|_{\xi=0} = \frac{A}{C}, \quad G_I^2 \Big|_{\xi \rightarrow \infty} = \frac{B}{D}. \quad (19)$$

Equating the two previous expressions results in

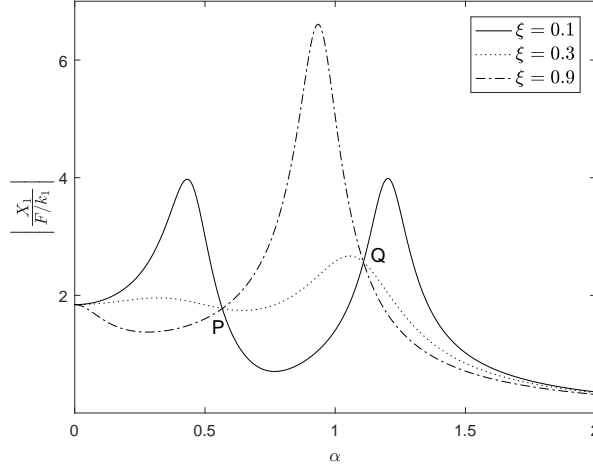

Fig. 2. Existence of fixed points in frequency response of a SDOF undamped primary system attached with a NSDVA-I. $\mu = 0.05$, $\beta = -0.1$ and $f = 1.6$. Solid line: $\xi = 0.1$, dotted line: $\xi = 0.3$, dash-dotted line: $\xi = 0.9$.

152

$$\frac{\beta + \mu(\phi - \Omega)}{[\beta + \mu(\phi - \Omega)](1 - \Omega) + \mu\phi(\beta - \mu\Omega)} = \pm \frac{1}{1 - \Omega + \beta - \mu\Omega} \quad (20)$$

153 The positive sign does not conduct to meaningful results, while the negative sign leads to a quadratic equation
 154 in Ω :

$$(\mu^2 + 2\mu)\Omega^2 - 2(\beta + \mu + \beta\mu + \mu\phi + \mu^2\phi)\Omega + \beta^2 + 2\beta + 2\mu\phi(1 + \beta) = 0 \quad (21)$$

155 from which the abscissas at the two fixed points satisfy the following condition:

$$\Omega_P + \Omega_Q = \frac{2(\beta + \mu + \beta\mu + \mu\phi + \mu^2\phi)}{\mu^2 + 2\mu} \quad (22)$$

156 Furthermore, the vibration magnitudes at Ω_P and Ω_Q should be equalized, namely:

$$G_I \Big|_{\xi \rightarrow \infty, \Omega = \Omega_P} = G_I \Big|_{\xi \rightarrow \infty, \Omega = \Omega_Q} \quad (23)$$

157 yielding another constraint on abscissas at fixed points that:

$$\Omega_P + \Omega_Q = \frac{2(1 + \beta)}{1 + \mu} \quad (24)$$

158 The combination of Eqs. (22) and (24) gives the optimal frequency tuning ratio $f_{I,\text{fpt}}$ as a function of the mass
 159 ratio μ and the negative stiffness ratio β :

$$f_{I,\text{fpt}} = \sqrt{\phi_{I,\text{fpt}}} = \sqrt{\frac{\mu - \beta}{\mu(1 + \mu)^2}} \quad (25)$$

160 The back substitution of Eq. (25) into (21) and solving the quadratic equation yield the abscissas at two fixed
 161 points, respectively,

$$\Omega_P = \frac{\mu(\mu+2)(\beta+1) - \sqrt{\mu(\mu+2)(\mu-\beta)^2}}{\mu(\mu+1)(\mu+2)}, \quad \Omega_Q = \frac{\mu(\mu+2)(\beta+1) + \sqrt{\mu(\mu+2)(\mu-\beta)^2}}{\mu(\mu+1)(\mu+2)}. \quad (26)$$

162 Then, the optimal maximum amplitude of FRF can be obtained as:

$$G_{I,\text{fpt}} = G_I \Big|_{\xi \rightarrow \infty, \Omega = \Omega_P} = G_I \Big|_{\xi \rightarrow \infty, \Omega = \Omega_Q} = \sqrt{\frac{\mu(\mu+2)}{(\mu-\beta)^2}} \quad (27)$$

163 Up to now, the only unknown tuning parameter is the absorber damping ratio ξ , and a direct way of determining
 164 its optimal value is to set as zero the partial derivative of FRF (16) with respect to Ω at fixed points P and
 165 Q , which could be cumbersome in some cases. Therefore, the Brock's approach [29] is adopted in this paper
 166 to obtain the optimal damping ratio ξ in avoidance of the tedious derivatives. Denoting the optimal squared
 167 magnitude at fixed points by $\hbar = G_{I,\text{fpt}}^2$, the mechanical damping ratio ξ can be expressed as a function of this
 168 amplitude in such a way that:

$$4\xi^2 = -\frac{A - \hbar C}{B - \hbar D} \quad (28)$$

169 Instead of imposing the horizontal tangent constraint at the fixed point P , we consider an adjacent point, \tilde{P} of
 170 abscissa $\Omega = \Omega_P + \epsilon$ with ϵ being the small perturbation in Ω , and equating its magnitude to \hbar at fixed points,
 171 i.e.:

$$4\xi^2 = -\frac{A - \hbar C}{B - \hbar D} \Big|_{\Omega = \Omega_P + \epsilon} = \frac{n_0 + n_1\epsilon + n_2\epsilon^2 + \dots}{d_0 + d_1\epsilon + d_2\epsilon^2 + \dots} \quad (29)$$

172 where the coefficients of ϵ are dependent of μ , β , ϕ and \hbar . It can be proven that the constant terms n_0 and d_0 are
 173 equal to zero when $\phi = \phi_{I,\text{fpt}}$, $\hbar = \hbar_{\text{opt}}$ and $\Omega = \Omega_P$ or Ω_Q . Therefore, the fraction n_0/d_0 is of intermediate form
 174 $0/0$ and the optimal damping ratio can be obtained by approaching $\epsilon \rightarrow 0$. According to the *de L'Hospital's*
 175 rule, one has:

$$4\xi_{I,\text{fpt}}^2 = \lim_{\epsilon \rightarrow 0} 4\xi^2 = \frac{n_1}{d_1} \quad (30)$$

176 with the numerator and denominator given by:

$$\begin{aligned} n_1 &= n_{10} + n_{11}\Omega + n_{12}\Omega^2 + n_{13}\Omega^3 \\ d_1 &= d_{10} + d_{11}\Omega + d_{12}\Omega^2 \end{aligned} \quad (31)$$

where all coefficients are expressed as:

$$\left\{ \begin{aligned} n_{10} &= -2\hbar\mu^2(\mu+1)(\beta+1)\phi^2 - 2\mu(\hbar\beta^2 + 2\hbar\beta\mu + 2\hbar\beta + \hbar\mu - \mu)\phi - 2\beta(\hbar\beta + \hbar\mu - \mu) \\ n_{11} &= 2\hbar\mu^2(\mu+1)^2\phi^2 + 4\hbar\mu(2\beta\mu + \mu^2 + \beta + 2\mu)\phi + 2\hbar\beta^2 + 8\hbar\beta\mu + 2\hbar\mu^2 - 2\mu^2 \\ n_{12} &= -6\hbar\mu(\mu^2\phi + \mu\phi + \beta + \mu) \\ n_{13} &= 4\hbar\mu^2 \\ d_{10} &= -\mu^2\phi(\hbar\beta^2 + 2\hbar\beta + \hbar - 1) \\ d_{11} &= 4\hbar\mu^2\phi(\mu+1)(\beta+1) \\ d_{12} &= -3\hbar\mu^2\phi(\mu+1)^2 \end{aligned} \right. \quad (32)$$

177 The optimal damping ratio $\xi_{I,\text{fpt}}$ can be then computed by substituting the optimal frequency tuning ratio (25),
 178 frequencies at fixed points (26) and peak magnitude (27) into Eq. (30). Clearly, two quasi-optimal solutions of

179 $\xi_{I,\text{fpt}}$ can be obtained at the two fixed points, which are denoted by ξ_P and ξ_Q and are slightly different with
 180 each other. Finally, their root mean square value is accepted as the optimal mechanical damping ratio, i.e.:

$$\xi_{I,\text{fpt}} = \sqrt{\frac{\xi_P^2 + \xi_Q^2}{2}} = \sqrt{\frac{\mu(2\beta\mu + 5\beta + 3)(\mu - \beta)^3}{4(\mu + 1)[\mu(\mu + 2)(\beta + 1)^2(\mu - \beta)^2 - (\mu - \beta)^4]}} \quad (33)$$

181 By imposing $\beta = 0$, Eq. (33) reduces to $\sqrt{3\mu/8(1 + \mu)}$, which is exactly the classic expression derived in [5] for
 182 the DVA-I without negative stiffness.

183 3.1.2. Lower limit and optimal value of β

184 By substituting the optimal frequency tuning ratio (25) into the general stability condition (15), an inequality
 185 on β can be obtained:

$$\beta^2 - (\mu^2 + 3\mu)\beta - \mu < 0 \quad (34)$$

186 suggesting that β should locate within the interval $(\beta_{I,\text{fpt}}^-, \beta_{I,\text{fpt}}^+)$, with the lower and upper limits defined by:

$$\beta_{I,\text{fpt}}^- = \frac{\mu^2 + 3\mu - \sqrt{(\mu^2 + 3\mu)^2 + 4\mu}}{2}, \quad \beta_{I,\text{fpt}}^+ = \frac{\mu^2 + 3\mu + \sqrt{(\mu^2 + 3\mu)^2 + 4\mu}}{2}. \quad (35)$$

187 It is noticeable that $\beta_{I,\text{fpt}}^+ > 0$ and $\beta_{I,\text{fpt}}^- > -1$ always hold for any positive μ . The allowable bound on β is then
 188 reduced to:

$$\beta \in (\beta_{I,\text{fpt}}^-, 0] \quad (36)$$

189 Fig. 3 depicts the frequency response surface of primary system against the dimensionless excitation frequency
 190 α and the negative stiffness ratio β with absorber parameters tuned by the fixed points theory. The curve
 191 C1 corresponds to the frequency response curve of a classic DVA-I, namely $\beta = 0$. It is apparent that the
 192 inclusion of negative stiffness does contribute to the decreasing of peak vibration amplitude and the increasing
 193 of absorbing frequency range. Nevertheless, the vibration amplitude at $\alpha = 0$, i.e. static displacement $X_{I,st}$ of
 194 primary system attached with a NSDVA-I, increases monotonically as the negative stiffness ratio β approaches
 195 to its lower limit $\beta_{I,\text{fpt}}^-$, which is in contrast with the trend of the magnitude at fixed points. Therefore, it could
 196 be postulated that the optimal negative stiffness ratio $\beta_{I,\text{fpt}}$ is achieved when are equalized the static amplitude
 197 of primary system $X_{I,st}$ and the peak magnitude \bar{h} given in Eq. (27). The static amplitude of primary system
 198 $X_{I,st}$ can be determined by imposing $\Omega = 0$ in Eq. (16), leading to:

$$X_{I,st} = G_I \Big|_{\Omega=0} = \frac{\mu + (\mu^2 + 2\mu)\beta}{\mu + (\mu^2 + 3\mu)\beta - \beta^2} \quad (37)$$

199 It is worth noting that $X_{I,st}$ deviates from unity in the presence of negative stiffness (namely $\beta \neq 0$), which
 200 designates that the static displacement of primary system is no longer controlled solely by the mechanical
 201 property of primary system but also influenced by the secondary oscillator. Equating Eqs. (27) and (37) yields
 202 four rational values of $\beta_{I,\text{fpt}}$, respectively:

$$\beta_1 = \frac{\mu^2 + 3\mu - (\mu + 1)\sqrt{\mu^2 + 2\mu}}{2 - (\mu + 1)^2}, \quad \beta_2 = \frac{\mu^2 + 3\mu + (\mu + 1)\sqrt{\mu^2 + 2\mu}}{2 - (\mu + 1)^2}, \quad (38)$$

$$\beta_3 = \frac{\mu^2 + 2\mu - (\mu + 1)\sqrt{\mu^2 + 2\mu}}{\mu + 2}, \quad \beta_4 = \frac{\mu^2 + 2\mu + (\mu + 1)\sqrt{\mu^2 + 2\mu}}{\mu + 2}.$$

203 where β_2 and β_4 are always positive for a mass ratio $\mu < 0.25$ which covers the most engineering applications in
 204 practice. Furthermore, β_1 is always inferior to the lower bound $\beta_{I,\text{fpt}}^-$ for any positive μ , with which the coupled
 205 system becomes unstable. Finally, β_3 satisfies the following condition:

$$-1 < \beta_{I,\text{fpt}}^- < \beta_3 < 0 \quad (39)$$

206 which clearly suggests the existence of an optimal negative stiffness ratio $\beta_{I,\text{fpt}}$ within the stable region, which
 207 is formulated as:

$$\beta_{I,\text{fpt}} = \beta_3 = \frac{\mu^2 + 2\mu - (\mu + 1)\sqrt{\mu^2 + 2\mu}}{\mu + 2} \quad (40)$$

208 Marked by C2, the frequency response of primary system with the optimal value $\beta_{I,\text{fpt}}$ is drawn in Fig. 3, where
 209 an equilibrium is established between the increasing of static displacement and the decreasing of vibration
 210 amplitude at fixed points as the negative stiffness goes up to its lower limit.

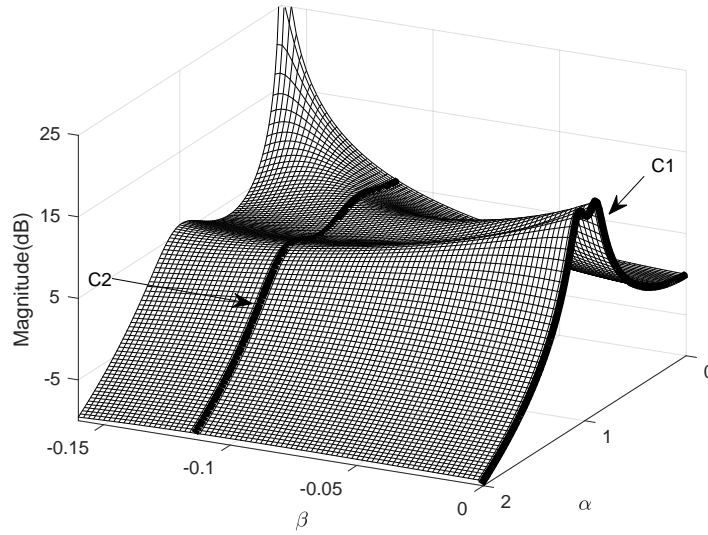

Fig. 3. Frequency response of primary system attached with a NSDVA-I versus the dimensionless frequency α and the negative stiffness ratio β with $\mu = 0.05$. Curve C1: $\beta = 0$, C2: $\beta = \beta_{I,\text{fpt}}$.

211 Fig. 4 depicts the evolution of peak vibration amplitude of primary system controlled by a NSDVA-I (marked
 212 by black solid curve) with respect to the stiffness ratio β when optimized by the fixed points theory. A minimum
 213 is observed in the peak amplitude curve within the stability region, at which the optimal negative stiffness ratio
 is defined and coincides with the one predicted by Eq. (40).

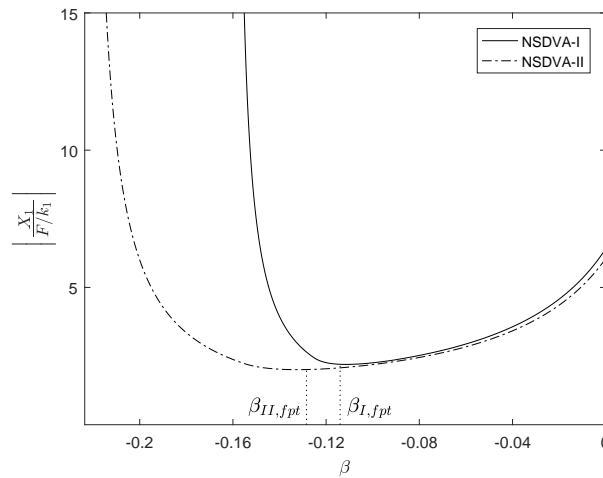

Fig. 4. Evolution of normalized peak vibration amplitude of primary system with respect to negative stiffness ratio β in the optimal scenario relevant to fixed points theory with given mass ratio $\mu = 0.05$. Solid line: NSDVA-I, dash-dotted line: NSDVA-II.

215 *3.2. Transient excitation scenario*

216 In practice, there exists other performance assessment than optimizing the steady state frequency response of
 217 primary system, e.g. shaping its transient response optimally in terms of fast attenuation and low peak response.
 218 As presented in the Introduction, this design objective could be achieved by tuning the NSDVA according to
 219 the stability maximization criterion.

220 *3.2.1. Optimal tuning based on stability maximization criterion*

221 Give that the coupled system is of two DOFs, there exist four eigenvalues for its characteristic polynomial,
 222 denoted by $\lambda_1, \lambda_2, \lambda_3$ and λ_4 . Therefore, the transient response of primary system under free vibration can be
 223 expressed in the form of:

$$x_1(\tau) = A_1 e^{\lambda_1 \tau} + A_2 e^{\lambda_2 \tau} + A_3 e^{\lambda_3 \tau} + A_4 e^{\lambda_4 \tau} \quad (41)$$

224 where A_1, A_2, A_3 and A_4 are coefficients in terms of rescaled time τ and are dependent of the initial state of
 225 the system. As proposed in [30], a performance index is defined as the absolute value of the maximal real part
 226 of all eigenvalues, i.e.:

$$\Lambda = -\max_i \left\{ \text{Re}(\lambda_i) \right\} \quad (42)$$

227 which indicates the slowest speed of convergence of the free vibration response and is termed as the degree of
 228 stability. Therefore, the stability maximization criterion aims at maximizing the degree of stability Λ , namely
 229 all eigenvalues should locate as far as possible away from the imaginary axis in the left half complex plane.

230 As stated in [30], the design objective is fulfilled when the eigenvalues of coupled system take the form of a
 231 double pair of complex conjugates. Denoting the eigenvalues by $\lambda_1 = \lambda_3 = -p + jq$ and $\lambda_2 = \lambda_4 = -p - jq$, p must
 232 be positive in order to locate at the left half complex plane and is exactly the degree of stability Λ . Thus, the
 233 characteristic polynomial can be factorized in terms of its eigenvalues:

$$(\lambda - \lambda_1) \cdot (\lambda - \lambda_2) \cdot (\lambda - \lambda_3) \cdot (\lambda - \lambda_4) = 0 \quad (43)$$

234 which can be expanded and further rearranged in the polynomial form of λ as:

$$\lambda^4 + 4p\lambda^3 + (4p^2 + 2r^2)\lambda^2 + 4pr^2\lambda + r^4 = 0 \quad (44)$$

235 with $r = \sqrt{p^2 + q^2}$ designating the modulus of complex poles. By comparing coefficients in Eqs. (13) and (44),
 236 four conditions should be satisfied simultaneously:

$$4p = 2\xi f(1 + \mu) \quad (45a)$$

$$4p^2 + 2r^2 = 1 + \frac{\beta}{\mu} + (1 + \mu)f^2 \quad (45b)$$

$$4pr^2 = 2\xi f(1 + \beta) \quad (45c)$$

$$r^4 = \frac{\beta}{\mu} + (1 + \beta)f^2 \quad (45d)$$

237 which culminate into the SMC-based optimal parameters of NSDVA-II as follows:

$$f_{1,\text{smc}} = \sqrt{\frac{(\mu - \beta)(1 - \beta\mu)}{\mu(1 + \beta)(1 + \mu)^2}}, \quad \xi_{1,\text{smc}} = \sqrt{\frac{\mu - \beta}{(1 + \mu)(1 - \beta\mu)}}. \quad (46)$$

238 which distinguish from the ones obtained in the harmonic scenario. Besides, the modulus and real part of
 239 eigenvalues (i.e. degree of stability) are written as:

$$r_{\text{I}} = \sqrt{\frac{1 + \beta}{1 + \mu}}, \quad \Lambda_{\text{I}} = p_{\text{I}} = \sqrt{\frac{(\mu - \beta)^2}{4\mu(1 + \mu)(1 + \beta)}}. \quad (47)$$

240 *3.2.2. Lower bound on β*

241 With the knowledge of frequency tuning ratio $f_{I,smc}$, the general stability condition (15) is always satisfied for
 242 any $\beta > -1$. However, another constraint should be considered for the SMC-based optimization procedure, i.e.

$$p \leq r \quad (48)$$

243 as required by the complex pole assumption, which yields an inequality condition on β :

$$(1 - 4\mu)\beta^2 - 10\mu\beta + \mu^2 - 4\mu \leq 0 \quad (49)$$

244 Given that μ is usually lower than 0.25 in practical applications, a lower limit can be determined for β as:

$$-1 < \beta_{I,smc}^- = \frac{\mu - 2\sqrt{\mu}}{1 + 2\sqrt{\mu}} < 0 \quad (50)$$

245 while the upper threshold related to Eq. (49) is always positive for any mass ratio μ . As a whole, the permissible
 246 interval of negative stiffness ratio β in this scenario is described by:

$$\beta \in [\beta_{I,smc}^-, 0] \quad (51)$$

247 The evolution of complex eigenvalues of the coupled system as a function of β is plotted in Fig. 5. One
 248 can notice that as the negative stiffness ratio approaches gradually to its lower threshold $\beta_{I,smc}^-$, the complex
 249 conjugate pair of eigenvalues move away from the imaginary axis of complex plane and migrate towards the
 250 real axis, designating a faster attenuation and a smaller oscillation cycle. When β arrives at its lower bound,
 251 all four poles coincide with each other and become real, whose abscissa is equal to $-1/(1 + 2\sqrt{\mu})$ and for which
 252 the ultimate mechanical damping ratio is written as:

$$\xi_{I,smc}^- = \sqrt{\frac{2\sqrt{\mu}}{(1 + \mu)(1 - \mu + 2\sqrt{\mu})}} \quad (52)$$

253 which clearly suggests that under no circumstance, the mechanical damping ratio of NSDVA-I tuned by the
 SMC could be greater than or equal to unity for $\mu < 0.25$.

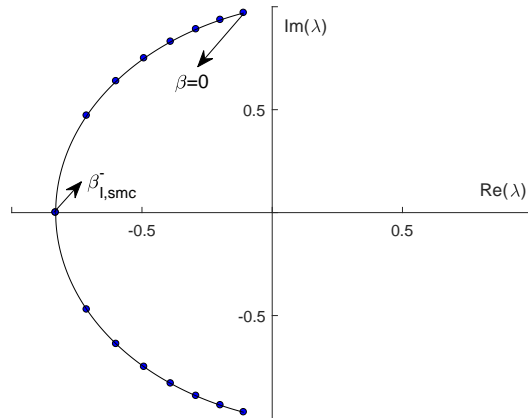

Fig. 5. Evolution of root loci of the primary system coupled with a NSDVA-I versus the negative stiffness ratio β in the SMC-based optimal scenario with given mass ratio $\mu = 0.05$. For each specific value of β , the coupled system has a double pair of complex conjugates.

255 4. Optimization of NSDVA-II

256 In this section, a non-traditional absorber NSDVA-II, as illustrated in Fig. 1d, is under consideration in both
 257 harmonic and free vibration cases. Although the optimization of NSDVA-II based on the fixed points theory
 258 is available in [25], its stability analysis and bound on negative stiffness ratio β had not been addressed, which
 259 will be accomplished in this paper. Furthermore, to the best knowledge of the authors, optimization based on
 260 stability maximization criterion is still lacking in the literature. Therefore, the optimization of NSDVA-II based
 261 on these two methods will be conducted by following the same procedure as in Section 3.

262 4.1. Harmonic excitation scenario

263 The primary system being excited harmonically, its squared amplitude of FRF can be cast in the form of Eq.
 264 (16) with the four coefficients expressed as:

$$\begin{aligned} A &= [\beta + \mu(\phi - \Omega)]^2, & B &= \mu^2\phi\Omega, \\ C &= [[\beta + \mu(\phi - \Omega)](1 - \Omega) + \mu\phi(\beta - \mu\Omega)]^2, & D &= \mu^2\phi\Omega(1 + \mu\phi - \Omega)^2. \end{aligned} \quad (53)$$

265 By employing the fixed points theory, the optimal frequency tuning ratio $f_{I,\text{fpt}}$ is formulated as the function of
 266 the mass ratio μ and the negative stiffness ratio β :

$$f_{II,\text{fpt}} = \sqrt{\frac{\mu - \beta}{\mu(1 - \mu)}} \quad (54)$$

267 The fixed points P and Q locate at:

$$\Omega_P = \frac{2\mu(1 - \beta) - \sqrt{2\mu(\mu - \beta)^2}}{2\mu(1 - \mu)}, \quad \Omega_Q = \frac{2\mu(1 - \beta) + \sqrt{2\mu(\mu - \beta)^2}}{2\mu(1 - \mu)}. \quad (55)$$

268 and the vibration amplitude at fixed points reads as:

$$G_{II,\text{fpt}} = \sqrt{\frac{2\mu(1 - \mu)^2}{(\mu - \beta)^2}} \quad (56)$$

269 Finally, the optimal damping ratio $\xi_{II,\text{fpt}}$ is determined by adopting Brock's approach, giving

$$\xi_{II,\text{fpt}} = \sqrt{\frac{3\mu(1 - \beta)(\mu - \beta)^3}{4[2\mu(1 - \beta)^2(\mu - \beta)^2 - (\mu - \beta)^4]}} \quad (57)$$

270 The substitution of Eq. (54) in the general stability condition (15) leads to:

$$\beta \in (\beta_{II,\text{fpt}}^-, 0] \quad (58)$$

271 with $\beta_{II,\text{fpt}}^- = -\sqrt{\mu}$. As stated in previous section, optimal value of β can be determined by equating the
 272 static displacement of primary system and the vibration amplitude at fixed points. In this scenario, the static
 273 displacement of primary system is described by:

$$X_{II,st} = G_{II}\Big|_{\Omega=0} = \frac{\mu(1 - \beta)}{\mu - \beta^2} \quad (59)$$

274 Then balancing Eqs. (56) and (59) yields four possible values of $\beta_{II,\text{fpt}}$, respectively:

$$\begin{aligned} \beta_1 &= \frac{-1 - (1 - \mu)\sqrt{2\mu}}{1 - 2\mu}, & \beta_2 &= \frac{-1 + (1 - \mu)\sqrt{2\mu}}{1 - 2\mu}, \\ \beta_3 &= \frac{\mu - (1 - \mu)\sqrt{2\mu}}{2 - \mu}, & \beta_4 &= \frac{\mu + (1 - \mu)\sqrt{2\mu}}{2 - \mu}. \end{aligned} \quad (60)$$

275 where β_2 and β_4 are greater than zero for any positive μ and $\beta_1 < \beta_{II, \text{fpt}}^-$ always holds for $\mu < 0.25$. The last
 276 possible solution satisfies: $\beta_{II, \text{fpt}}^- < \beta_3 < 0, \forall \mu \in (0, 0.25)$, which should be then retained. Finally, the optimal
 277 negative stiffness ratio $\beta_{II, \text{fpt}}$ for the NSDVA-II is formulated as:

$$\beta_{II, \text{fpt}} = \frac{\mu - (1 - \mu)\sqrt{2\mu}}{2 - \mu} \quad (61)$$

278 which is exactly the same as that proposed in [25]. Again the optimal formula (61) is validated by inspecting the
 279 frequency response of primary system with this specific value. As evident from Fig. 6, the static displacement
 280 and the vibration amplitude at fixed points are balanced in the frequency response relevant to $\beta_{II, \text{fpt}}$ (denoted
 as C4).

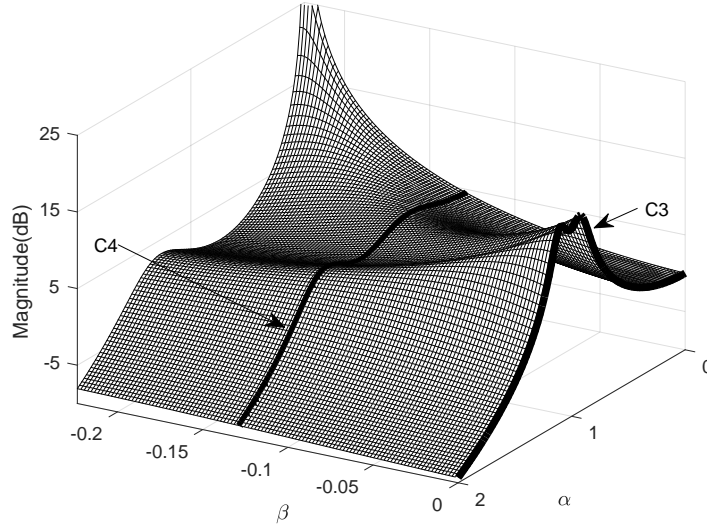

Fig. 6. Frequency response of primary system attached with a NSDVA-II versus the dimensionless frequency α and the negative stiffness ratio β with $\mu = 0.05$. Curve C3: $\beta = 0$, C4: $\beta = \beta_{II, \text{fpt}}$.

281

282 4.2. Transient excitation scenario

283 In this scenario, the stability maximization criterion is adopted to improve the transient response of primary
 284 system connected with a NSDVA-II. By balancing the coefficients of corresponding characteristic polynomial
 285 (14) with the ones of the optimized characteristic polynomial (44), four optimality conditions should be fulfilled:

286

$$4p = 2\xi f \quad (62a)$$

$$4p^2 + 2r^2 = 1 + \frac{\beta}{\mu} + (1 + \mu)f^2 \quad (62b)$$

$$4pr^2 = 2\xi f(1 + \mu f^2) \quad (62c)$$

$$r^4 = \frac{\beta}{\mu} + (1 + \beta)f^2 \quad (62d)$$

287 from which one can determine the optimal tuning parameters of NSDVA-II as:

$$f_{II, \text{smc}} = \sqrt{\frac{1 + \beta - 2\mu - \sqrt{(1 + \beta)^2 - 4\mu}}{2\mu^2}}, \quad \xi_{II, \text{smc}} = \sqrt{\frac{1 - \beta - \sqrt{(1 + \beta)^2 - 4\mu}}{2}}. \quad (63)$$

	Frequency ratio f	Mechanical damping ratio ξ	$\left\ \frac{X_1}{F/k_1} \right\ _{\infty}$
DVA-I [5]	$\frac{1}{1+\mu}$	$\sqrt{\frac{3\mu}{8(1+\mu)}}$	$\sqrt{\frac{\mu+2}{\mu}}$
NSDVA-I	$\sqrt{\frac{\mu-\beta}{\mu(1+\mu)^2}}$	$\sqrt{\frac{\mu(2\beta\mu+5\beta+3)(\mu-\beta)^3}{4(\mu+1)[\mu(\mu+2)(\beta+1)^2(\mu-\beta)^2-(\mu-\beta)^4]}}$	$\sqrt{\frac{\mu(\mu+2)}{(\mu-\beta)^2}}$
DVA-II [6]	$\frac{1}{\sqrt{1-\mu}}$	$\sqrt{\frac{3\mu}{4(2-\mu)}}$	$(1-\mu)\sqrt{\frac{2}{\mu}}$
NSDVA-II [25]	$\sqrt{\frac{\mu-\beta}{\mu(1-\mu)}}$	$\sqrt{\frac{3\mu(1-\beta)(\mu-\beta)^3}{4[2\mu(1-\beta)^2(\mu-\beta)^2-(\mu-\beta)^4]}}$	$(1-\mu)\sqrt{\frac{2\mu}{(\mu-\beta)^2}}$

Table 1: Optimal parameters of various types of DVAs based on the fixed points theory.

	Frequency ratio f	Damping ratio ξ	Degree of stability Λ
DVA-I [10]	$\frac{1}{1+\mu}$	$\sqrt{\frac{\mu}{1+\mu}}$	$\sqrt{\frac{\mu}{4(1+\mu)}}$
NSDVA-I	$\sqrt{\frac{(\mu-\beta)(1-\beta\mu)}{\mu(1+\beta)(1+\mu)^2}}$	$\sqrt{\frac{\mu-\beta}{(1+\mu)(1-\beta\mu)}}$	$\sqrt{\frac{(\mu-\beta)^2}{4\mu(1+\mu)(1+\beta)}}$
DVA-II [11]	$\frac{1-\sqrt{1-4\mu}}{2\mu}$	$\sqrt{\frac{1-\sqrt{1-4\mu}}{2}}$	$\sqrt{\frac{1-3\mu-(1-\mu)\sqrt{1-4\mu}}{8\mu^2}}$
NSDVA-II	$\sqrt{\frac{1+\beta-2\mu-\sqrt{(1+\beta)^2-4\mu}}{2\mu^2}}$	$\sqrt{\frac{1-\beta-\sqrt{(1+\beta)^2-4\mu}}{2}}$	$\sqrt{\frac{1+\beta-(3-\beta)\mu-(1-\mu)\sqrt{(1+\beta)^2-4\mu}}{8\mu^2}}$

Table 2: Optimal parameters of various types of DVAs according to the stability maximization criterion.

288 and the modulus and real part of eigenvalues (i.e. degree of stability) given by:

$$r_{II} = \sqrt{\frac{1+\beta-\sqrt{(1+\beta)^2-4\mu}}{2\mu}}, \quad \Lambda_{II} = p_{II} = \sqrt{\frac{1+\beta-(3-\beta)\mu-(1-\mu)\sqrt{(1+\beta)^2-4\mu}}{8\mu^2}}. \quad (64)$$

289 The authors remark that in the case of NSDVA-II, the lower limit of β is not unique for $\mu \in [0, 0.25]$ so that
290 one should investigate the threshold of β per segment of μ . The lower bounds on negative stiffness ratio β are
291 given directly as follows:

$$\beta_{II,smc}^- = \begin{cases} \frac{\mu+2\sqrt{\mu}(5\mu-1)}{1-4\mu}, & 0 \leq \mu < \frac{1}{9}; \\ \frac{7\mu-1}{1-3\mu}, & \frac{1}{9} \leq \mu \leq \frac{1}{7}; \\ 2\sqrt{\mu}-1, & \frac{1}{5} \leq \mu \leq \frac{1}{4}. \end{cases} \quad (65)$$

292 whose detailed deduction is annexed in the appendix A.

293 At this point, it is pertinent to summarize all analytical formulae of optimal tuning parameters for both types
294 of NSDVAs based on different optimization criteria and compare with those available in the literature. In Table

	FPT	SMC
NSDVA-I	$\beta > \beta_{I,\text{fpt}}^- = \frac{\mu^2 + 3\mu - \sqrt{(\mu^2 + 3\mu)^2 + 4\mu}}{2}$	$\beta \geq \beta_{I,\text{smc}}^- = \frac{\mu - 2\sqrt{\mu}}{1 + 2\sqrt{\mu}}$
NSDVA-II	$\beta > \beta_{II,\text{fpt}}^- = -\sqrt{\mu}$	$\beta \geq \beta_{II,\text{smc}}^-$ given in Eq. (65)

Table 3: Lower bounds on negative stiffness ratio β for two types of NSDVAs based on different optimization criteria.

1 are summarized the optimal frequency tuning ratios and mechanical damping ratios of both classic DVAs and
 296 NSDVAs optimized according to the fixed points theory and the normalized vibration amplitudes at invariant
 297 points are also listed. Clearly, the optimal expressions of NSDVA-I in the second row (or NSDVA-II in the
 298 fourth row) reduce to the classic formulae of DVA-I in the first row (or DVA-II in the third row) by imposing
 299 $\beta = 0$. Similarly, the optimal tuning parameters of different DVAs calibrated by the stability maximization
 300 criterion as well as their performance indices are outlined in Table 2. Finally, in Table 3 are arranged all lower
 301 thresholds of negative stiffness ratio β for both types of NSDVAs with respect to two tuning strategies.

302 5. Numerical simulations and analyses

303 In this section, numerical simulations will be performed in order to illustrate the effect of negative stiffness on
 304 vibration control performance in both harmonic and transient scenarios by comparing with the classic DVAs.
 305 In the following study, the results are obtained with the mass ratio being $\mu = 0.05$ except for specific cases.
 306 The responses in the frequency domain are plotted directly by using the FRFs (7) and (10), meanwhile, the
 307 temporal responses are obtained by solving the dimensionless equations of motion (6) and (9) via the fourth-
 order Runge-Kutta method with a fixed and sufficiently small time step.

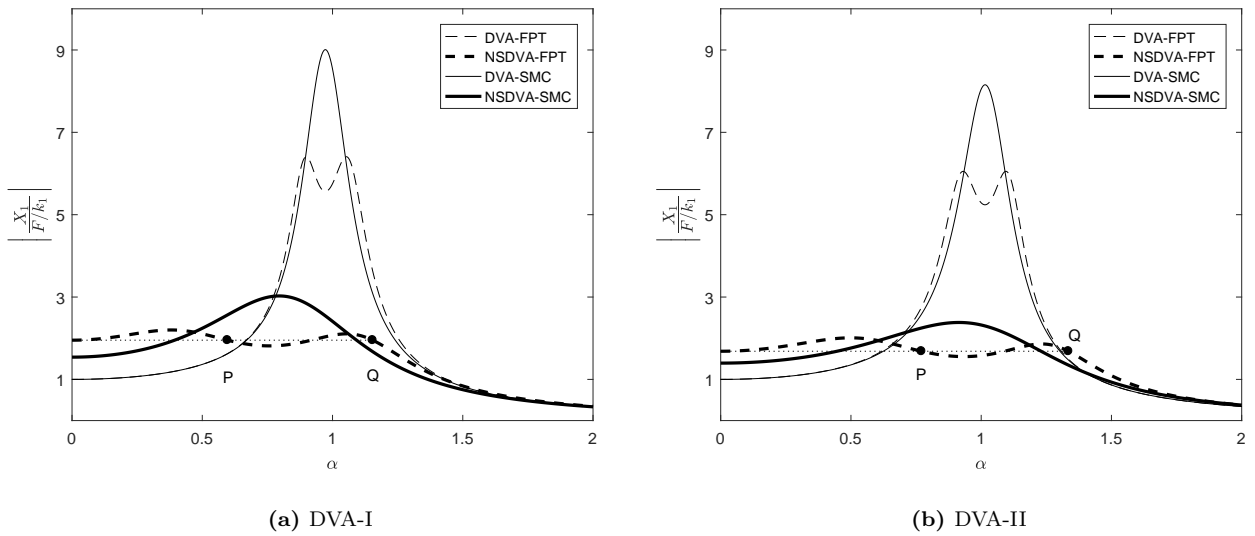

Fig. 7. Frequency responses of primary structure attached to: (a) DVA-I; (b) DVA-II. Thin lines correspond to classic DVAs (namely $\beta = 0$), Thick lines are related to NSDVAs with optimal negative stiffness ratio ($\beta = \beta_{I,\text{fpt}}$ or $\beta_{II,\text{fpt}}$). Dashed and solid lines are responses optimized by fixed points theory and stability maximization criterion, respectively. For both configurations, vibration responses at fixed points P and Q have the same amplitude as the corresponding static displacement.

309 5.1. Harmonic vibration case

310 Fig. 7 depicts the normalized frequency responses of primary system attached with four aforementioned types
 311 of DVAs under sinusoidal force excitation. The frequency responses with DVA-I are plotted in Fig. 7a, while
 312 the performance of non-traditional DVAs is illustrated in Fig. 7b. The thin lines correspond to the absence
 313 of negative stiffness (i.e. $\beta = 0$), while the thick lines are related to the case with optimal negative stiffness
 314 ratio $\beta_{I,\text{fpt}}$ or $\beta_{II,\text{fpt}}$. Finally, the dashed and solid curves are relevant to DVAs optimized by FPT and SMC,
 315 respectively. It is evident that compared to the SMC, the FPT contributes to the minimizing of peak vibration
 316 amplitude of primary system in the steady state and to a relatively large frequency bandwidth of vibration
 317 suppression. Moreover, in the frequency responses related to NSDVAs with optimal negative stiffness ratio,
 318 the vibration amplitude at fixed points P and Q is equal to the static deformation (i.e. at $\alpha = 0$), validating
 319 the aforementioned postulation on optimality condition. By inspecting frequency responses relevant to DVAs
 320 and NSDVAs, one can infer that the addition of negative stiffness leads to the decrease of peak vibration
 321 amplitude, the broadening of suppression bandwidth and the left shifting of resonance area for both optimal
 322 NSDVAs. Furthermore, it is hinted that given the same mass ratio, the DVA-II (or NSDVA-II) can provide a
 323 better control performance than the DVA-I (or NSDVA-I, respectively) in terms of reducing the peak vibration
 324 amplitude of primary system.

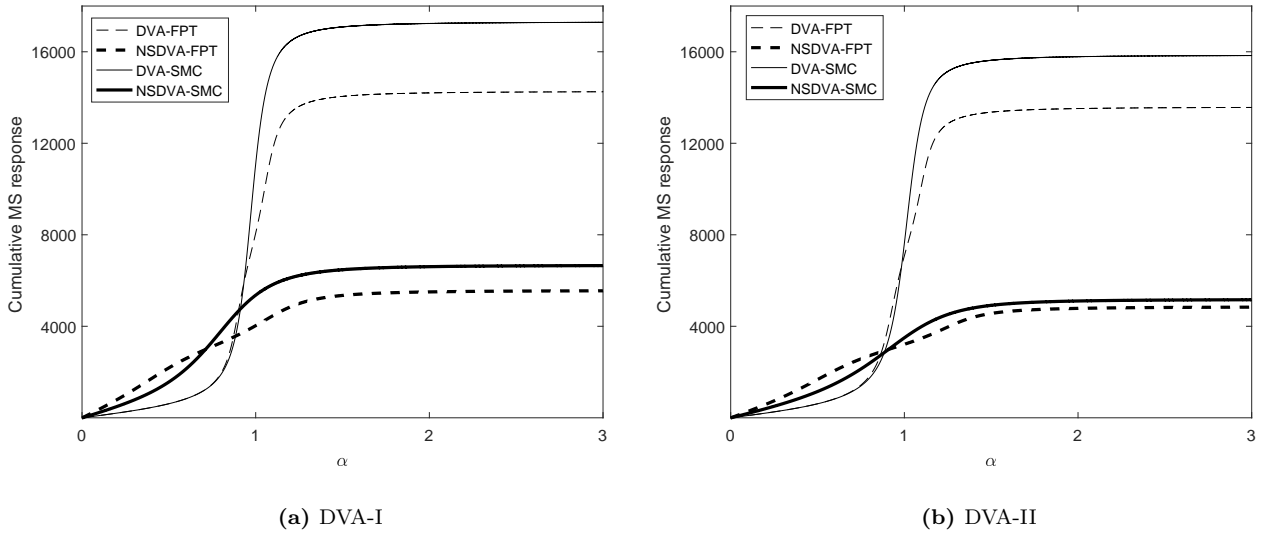

Fig. 8. Cumulative mean square value of normalized displacement of primary system: (a) DVA-I; (b) DVA-II. Thin lines correspond to classic DVAs (namely $\beta = 0$), thick lines are related to NSDVAs with optimal negative stiffness ratio ($\beta = \beta_{I,\text{fpt}}$ or $\beta_{II,\text{fpt}}$). Dashed and solid lines are responses optimized by fixed points theory and stability maximization criterion, respectively.

325 The main drawback of negative stiffness is to amplify the vibration amplitude of primary system in low
 326 frequency region. Nevertheless, the justification of its use in control scheme could be twofold: improved frequency
 327 responses over a larger area around resonance as previously discussed and reduced cumulative mean square
 328 response (CMSR) of primary mass, which is illustrated in Fig. 8. The dimensionless CMSR is defined as the
 329 integrated value of squared normalized displacement of primary system over a certain frequency range [31],
 330 standing for the total kinetic energy of primary mass when undergoing a broadband excitation. Fig. 8 clearly
 331 suggests that both NSDVAs can reduce the peak value of CMSR by a factor close to 3, signifying that the use
 332 of negative stiffness can enhance significantly the system damping capability against external disturbance.

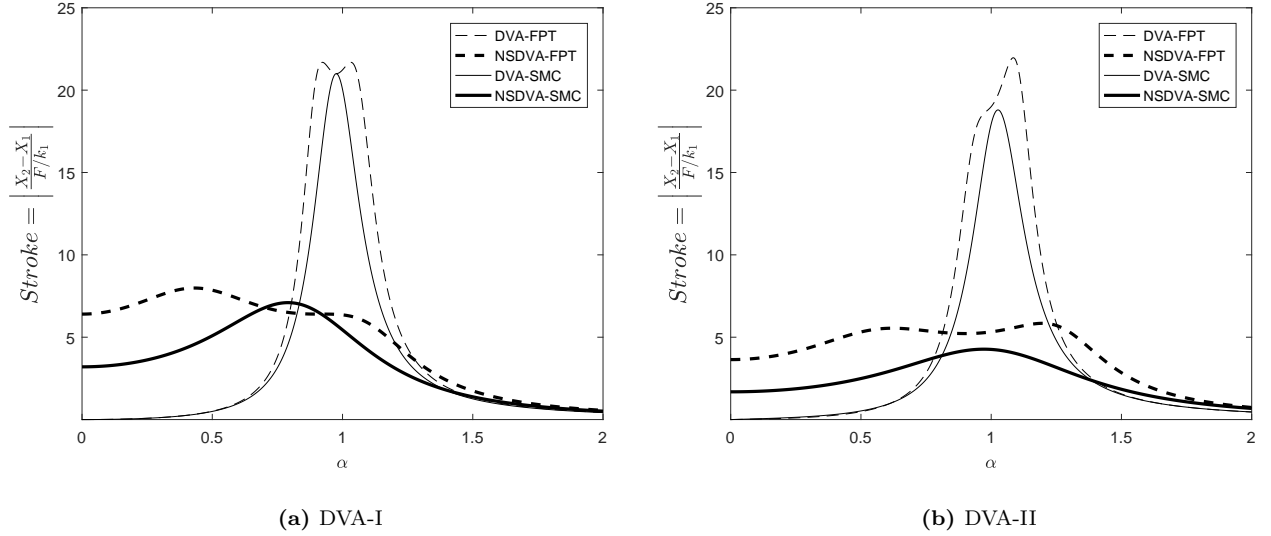

Fig. 9. Frequency responses of relative displacement between primary and secondary masses: (a) DVA-I; (b) DVA-II. Thin lines correspond to classic DVAs (namely $\beta = 0$), thick lines are related to NSDVAs with optimal negative stiffness ratio ($\beta = \beta_{I,\text{fpt}}$ or $\beta_{II,\text{fpt}}$). Dashed and solid lines are responses optimized by fixed points theory and stability maximization criterion, respectively.

333 More benefit could be introduced into the control performance by using the negative stiffness. Fig. 9
 334 demonstrates frequency responses of relative motion between primary and secondary masses, also termed as the
 335 stroke length, under harmonic force excitation. One can remark that both NSDVAs can reduce significantly the
 336 peak vibration amplitude of stroke length compared to their DVA counterparts, which facilitates their practical
 337 implementation in a more strict environment.

338 Nevertheless, the FPT is not oriented towards the optimization of damping ratio ξ^* of coupled system,
 339 which is defined as the minimal value of all modal damping ratios. The modal damping ratio associated with a
 340 specific eigenvalue is determined as the absolute value of ratio between its real part and its complex modulus.
 341 Therefore, increasing ξ^* leads to the decrease of damped natural frequency so that the required oscillation cycle
 342 for decaying the disturbance to zero is reduced. Fig. 10 demonstrates the evolution of system damping ratio
 343 ξ^* as a function of negative stiffness ratio β for the NSDVA-I (in Fig. 10a) and the NSDVA-II (in Fig. 10b).
 344 For both NSDVAs, FPT always yields a smaller value of ξ^* than SMC over the whole range of β , implying that
 345 SMC is more preferable for tuning NSDVAs in the case where a larger damping ratio is needed. Moreover, one
 346 can observe that the system damping value at the optimal negative stiffness ratio, $\beta_{I,\text{fpt}}$ or $\beta_{II,\text{fpt}}$, is not the
 347 largest, validating the fact that FPT aims at improving the steady state response instead of maximizing the
 348 damping capability.

349 5.2. Transient vibration case

350 The capability of decaying transient disturbances can be also quantified by taking the degree of stability Λ
 351 as the performance index. In fact, Λ represents the slowest exponential decay speed of transient response,
 352 therefore, a larger value of Λ corresponds to a faster decay of disturbance. Fig. 11 depicts the eigenvalues of
 353 primary system controlled by a DVA-I (in Fig. 11a) or a DVA-II (in Fig. 11b). With the definition of degree
 354 of stability given in Eq. (42), the performance indices for different DVAs read as: $\Lambda_{I,\text{fpt}} = 0.061$, $\Lambda_{I,\text{smc}} = 0.11$
 355 and $\Lambda_{I,\text{smc}}^- = 0.83$ for DVA-I based on different optimization criteria, and $\Lambda_{II,\text{fpt}} = 0.067$, $\Lambda_{II,\text{smc}} = 0.12$ and
 356 $\Lambda_{II,\text{smc}}^- = 1.35$ for DVA-II with different tuning parameters. Performance indices without any superscript are

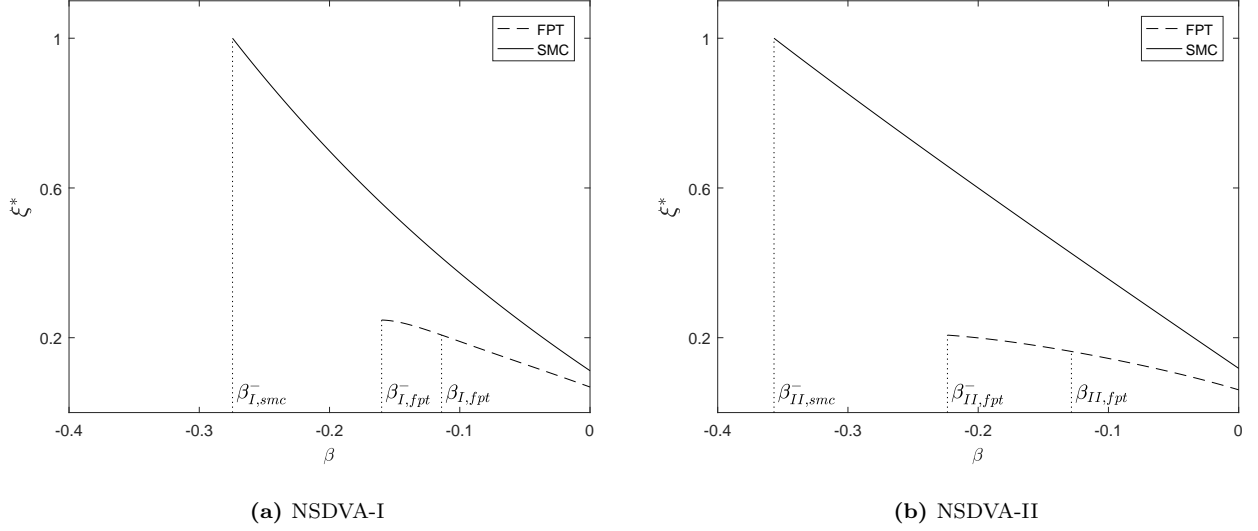

Fig. 10. The fluctuation of system damping ratio ξ^* as a function of the negative stiffness ratio β : (a) NSDVA-I, (b) NSDVA-II. Dashed and solid curves are related to FPT- and SMC-based optimization, respectively.

357 related to DVAs without negative stiffness, while those with the superscript, $-$, are related to NSDVAs with
 358 critical negative stiffness ratio $\beta_{I,smc}^-$ or $\beta_{II,smc}^-$. It clearly suggests that the SMC always conducts to a double
 359 pair of complex eigenvalues and a larger performance index than the FPT, namely a faster convergence of
 360 transient response. In the ultimate scenario with SMC-based optimization, all the eigenvalues are coincident
 361 with each other and locates at the real axis of the complex plane, at which the largest degree of stability can
 362 be achieved. Furthermore, DVA-II has a slightly better performance index than DVA-I with $\beta = 0$, while the
 363 inclusion of negative stiffness renders the advantage claimed for DVA-II over DVA-I more significant. Precisely,
 364 an increase of 62.7% in terms of performance index is observed for the NSDVA-II when compared to NSDVA-I
 365 at their respective lower bound on β .

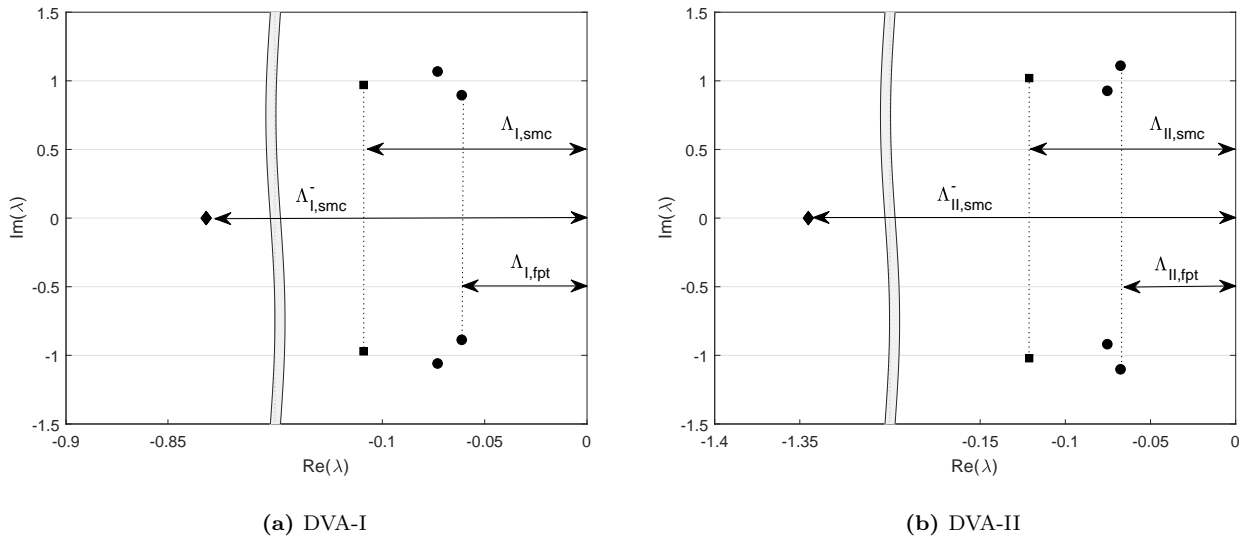

Fig. 11. Root loci of primary system coupled with a: (a) DVA-I; (b) DVA-II. Circle and square markers: classic DVA optimized by FPT and SMC, respectively (i.e. $\beta = 0$); diamond marker: SMC-based NSDVA with critical negative stiffness ratio $\beta_{I,smc}^-$ or $\beta_{II,smc}^-$. The performance indices read as: (a) $\Lambda_{I,fpt} = 0.061$, $\Lambda_{I,smc} = 0.11$ and $\Lambda_{I,smc}^- = 0.83$; (b) $\Lambda_{II,fpt} = 0.067$, $\Lambda_{II,smc} = 0.12$ and $\Lambda_{II,smc}^- = 1.35$.

366 A numerical simulation in the temporal domain is also carried out to investigate the control performance
367 of various DVAs with respect to transient vibration. Fig. 12 plots the temporal responses of primary system
368 and stroke length of absorber for different configurations. The simulation is performed under free vibration
369 (namely $F(\tau) = 0$) with a relatively large mass ratio $\mu = 0.1$ for a better visual effect. The initial states of two
370 DOFs are imposed as: $x_1(0) = z_0 = 0.1$ and $x'_1(0) = x_2(0) = x'_2(0) = 0$. The temporal solutions related to the
371 dimensionless ordinary differential equations (6) and (9) are obtained by adopting the fourth order Runge-Kutta
372 method with a fixed time step $1e-4$ for a simulation duration of 60. As evident from Figs. 12a and 12b, SMC
373 and FPT render a similar attenuation performance of transient response of primary system in terms of the peak
374 vibration amplitude and the settling time when $\beta = 0$, which is consistent with the prediction according to the
375 performance index. Besides, the SMC-based NSDVA-II with critical negative stiffness ratio outperforms the
376 NSDVA-I in terms of much more shorter settling time and lower peak amplitude of primary system. Finally,
377 Figs. 12c and 12d suggest that SMC is more preferable than FPT in terms of confining the peak vibration
amplitude of stroke length of DVA.

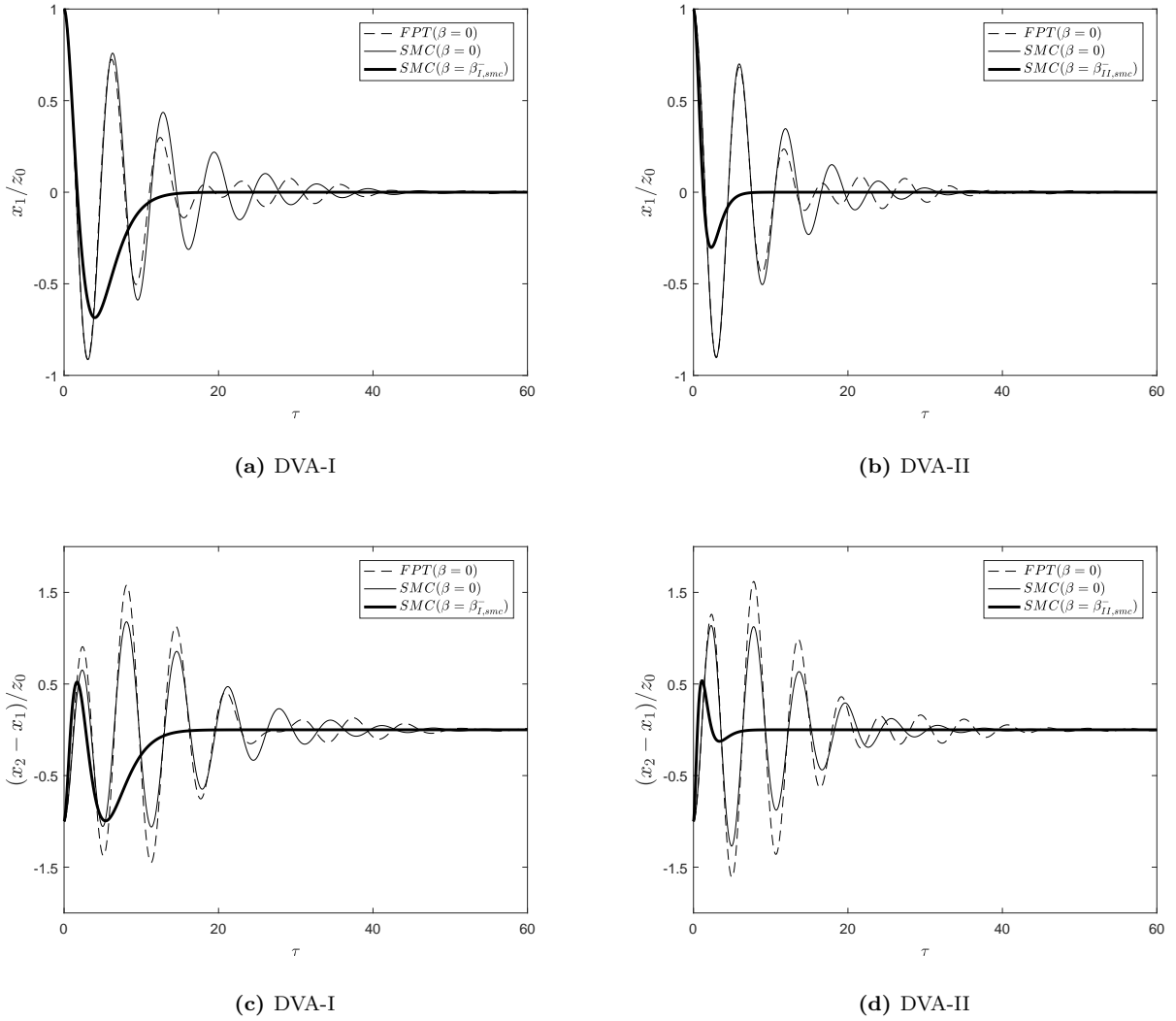

Fig. 12. Transient responses under free vibration normalized by the initial displacement of primary system z_0 : (a)-(b) displacement of primary system; (c)-(d) stroke lengths of DVAs. The mass ratio is imposed as $\mu = 0.10$. Dashed line: FPT-based DVAs (with $\beta = 0$); thin solid line: SMC-based DVAs (with $\beta = 0$); thick solid line: SMC-based NSDVAs with critical negative stiffness ratio (i.e. $\beta_{I,smc}^-$ or $\beta_{II,smc}^-$).

379 6. Conclusions

380 In this paper, optimization of both NSDVA-I and NSDVA-II is carried out based on two tuning strategies,
 381 fixed points theory and stability maximization criterion. Optimal parameters of frequency tuning ratio and
 382 mechanical damping ratio of absorber are derived analytically. And allowable bound on negative stiffness is
 383 specified for each NSDVA and for each optimization scenario based on the stability requirement. Besides, an
 384 optimal negative stiffness ratio is defined when the NSDVA is optimized according to the fixed points theory.

385 Numerical simulation results demonstrate that under harmonic excitation, the inclusion of negative stiffness
 386 can reduce significantly the maximum vibration amplitude of primary system and the stroke length of DVA
 387 and increase the frequency bandwidth of vibration suppression. Moreover, it is shown that the system damping
 388 increases as the negative stiffness approaches to its lower limit. Finally, temporal responses under free vibration
 389 suggest that in the ultimate scenario, the SMC-based NSDVAs can attenuate the transient response in an
 390 extremely short duration.

391 Comparisons between the two types of DVAs are also made. It is apparent that DVA-II (or NSDVA-II)
 392 can provide a better control performance than DVA-I (or NSDVA-I) in terms of confining the peak vibration
 393 amplitude of primary system and stroke length of absorber. These two types of DVAs with $\beta = 0$ have a similar
 394 performance of attenuating transient disturbance. When a negative stiffness is present, the SMC-based NSDVA-
 395 II can provide a better damping performance and have a larger permissible interval for the negative stiffness,
 396 comparing to the NSDVA-I. Therefore, the NSDVA-II can yield a more rapid convergence of transient response
 397 of both primary system and stroke length of absorber and can reduce their peak response more significantly.

398 7. Acknowledgements

399 This research did not receive any specific grant from funding agencies in the public, commercial, or not-for-profit
 400 sectors.

401 Appendix A Allowable interval of β for SMC-based optimization of NSDVA-II

402 Multiple constraints exist on the negative stiffness ratio β , as discussed one by one in the following study.

- 403 1. The stability requirement. The substitution of optimal frequency tuning ratio $f_{II,smc}$ into the general
 404 stability condition (15) yields:

$$(1 + \beta)^2 - 2\mu > (1 + \beta)\sqrt{(1 + \beta)^2 - 4\mu} \quad (\text{A.1})$$

405 which results in a possible bound on β : $\beta > \beta_1 = \sqrt{2\mu} - 1$.

- 406 2. $f_{II,smc}^2 \geq 0$. This condition imposes that:

$$\left. \begin{array}{l} 1 + \beta \geq 2\mu \\ (1 + \beta)^2 \geq 4\mu \\ (1 + \beta - 2\mu)^2 \geq (1 + \beta)^2 - 4\mu \end{array} \right\} \implies \left\{ \begin{array}{l} \beta \geq \beta_2 = 2\mu - 1 \\ \beta \geq \beta_3 = 2\sqrt{\mu} - 1 \end{array} \right. \quad (\text{A.2})$$

One can tell that $\beta_3 > \beta_1 > \beta_2$ always holds for any positive $\mu \leq 0.5$ and the mass ratio should be inferior to 0.25. Up to now, the negative stiffness ratio β should be bounded by: $\beta \geq \beta_3 = 2\sqrt{\mu} - 1$.

3. The complex eigenvalue assumption $p_{II}^2 \leq r_{II}^2$. The inequality conducts to $t_1 \leq t_2$ with the two polynomials given by:

$$t_1 = 1 - 7\mu + \beta(1 - 3\mu), \quad t_2 = (1 - 5\mu)\sqrt{(1 + \beta)^2 - 4\mu}. \quad (\text{A.3})$$

It is remarkable that the signs of t_1 and t_2 depend on the mass ratio μ so that the lower bound on β should be deducted per segment of μ . The coefficient t_1 will be positive if $\beta > \beta_4 = (7\mu - 1)/(1 - 3\mu)$ and t_2 remains positive when μ is less than 1/5. Besides, one can tell that $\beta_3 \geq \beta_4$ for any $\mu \in [0, 1/9]$. Therefore, three possible cases where a negative stiffness could be employed in the DVA, i.e. $\beta < 0$, are listed as follows:

- Case 1: $\beta \geq \beta_3$, $\beta_3 \leq 0$, $0 \leq t_1 \leq t_2$, $\forall \mu \in \left[0, \frac{1}{9}\right]$,
- Case 2: $\beta \geq \beta_4$, $\beta_4 \leq 0$, $0 \leq t_1 \leq t_2$, $\forall \mu \in \left[\frac{1}{9}, \frac{1}{5}\right]$,
- Case 3: $\beta \geq \beta_3$, $\beta_3 \leq 0$, $t_1 \leq t_2 \leq 0$, $\forall \mu \in \left[\frac{1}{5}, \frac{1}{4}\right]$.

each of which will be investigated in order to obtain the lower bound on β with respect to the segment of mass ratio μ .

- Case 1. $\beta < 0$ always holds for $\mu \in [0, 1/9]$. Moreover, the condition $0 \leq t_1 \leq t_2$ results in:

$$(1 - 4\mu)\beta^2 - 2\mu\beta + 25\mu^2 - 4\mu \leq 0 \quad (\text{A.4})$$

It is noticeable that the upper limit of this inequality is always positive, therefore, the corresponding bound on β is: $\beta_5 \leq \beta \leq 0$ with

$$\beta_5 = \frac{\mu + 2\sqrt{\mu}(5\mu - 1)}{1 - 4\mu} \quad (\text{A.5})$$

With β_5 being superior to β_3 in the very range of mass ratio, the allowable bound on β is:

$$\beta_5 \leq \beta \leq 0, \forall \mu \in \left[0, \frac{1}{9}\right]. \quad (\text{A.6})$$

- Case 2. In this range of mass ratio, the condition $0 \leq t_1 \leq t_2$ will be satisfied if $\beta \geq \beta_4$ holds. Nevertheless, β_4 will be positive when the mass ratio is greater than 1/7. Therefore, no negative stiffness could be employed in the range of $[1/7, 1/5]$ and the permissible bound on β is expressed as:

$$\beta_4 \leq \beta \leq 0, \forall \mu \in \left[\frac{1}{9}, \frac{1}{7}\right]. \quad (\text{A.7})$$

- Case 3. The constraint of $t_1 \leq t_2 \leq 0$ gives rise to

$$\beta \leq \beta^- = \frac{\mu - 2\sqrt{\mu}(5\mu - 1)}{1 - 4\mu}, \quad \beta \geq \beta^+ = \frac{\mu + 2\sqrt{\mu}(5\mu - 1)}{1 - 4\mu} \quad (\text{A.8})$$

In the mass ratio range of $[1/5, 1/4]$, $\beta^+ > \beta^- > 0$ always holds. Therefore, the corresponding interval of β is given as:

$$\beta_3 \leq \beta \leq 0, \forall \mu \in \left[\frac{1}{5}, \frac{1}{4}\right]. \quad (\text{A.9})$$

Finally, the lower thresholds of negative stiffness ratio β are found for each segment of mass ratio μ and are summarized in Eq. (65).

434 **References**

- 435 [1] C. C. Chang, Mass dampers and their optimal designs for building vibration control, *Engineering Structures*
436 21 (5) (1999) 454–463. doi:10.1016/S0141-0296(97)00213-7.
- 437 [2] Q. Li, J. Fan, J. Nie, Q. Li, Y. Chen, Crowd-induced random vibration of footbridge and vibration control
438 using multiple tuned mass dampers, *Journal of Sound and Vibration* 329 (19) (2010) 4068–4092. doi:
439 10.1016/j.jsv.2010.04.013.
- 440 [3] M. H. Miguelez, L. Rubio, J. A. Loya, J. Fernandez-Saez, Improvement of chatter stability in boring
441 operations with passive vibration absorbers, *International Journal of Mechanical Sciences* 52 (10) (2010)
442 1376–1384. doi:10.1016/j.ijmecsci.2010.07.003.
- 443 [4] S. Chesne, G. Inquiere, P. Cranga, F. Legrand, B. Petitjean, Innovative hybrid mass damper for dual-loop
444 controller, *Mechanical Systems and Signal Processing* 115 (2019) 514–523. doi:10.1016/j.ymsp.2018.
445 06.023.
- 446 [5] J. Den Hartog, *Mechanical vibrations*, 4th Edition, McGraw-Hill, New York, 1956.
- 447 [6] M. Z. Ren, A variant design of the dynamic vibration absorber [3], *Journal of Sound and Vibration* 245 (4)
448 (2001) 762–770. doi:10.1006/jsvi.2001.3564.
- 449 [7] O. Nishihara, T. Asami, Closed-form solutions to the exact optimizations of dynamic vibration absorbers
450 (minimizations of the maximum amplitude magnification factors), *Journal of Vibration and Acoustics*,
451 *Transactions of the ASME* 124 (4) (2002) 576–582. doi:10.1115/1.1500335.
- 452 [8] N. D. Anh, N. X. Nguyen, Design of tmd for damped linear structures using the dual criterion of equivalent
453 linearization method, *International Journal of Mechanical Sciences* 77 (2013) 164–170. doi:10.1016/j.
454 ijmecsci.2013.09.014.
- 455 [9] N. D. Anh, N. X. Nguyen, N. H. Quan, Global-local approach to the design of dynamic vibration absorber
456 for damped structures, *JVC/Journal of Vibration and Control* 22 (14) (2016) 3182–3201. doi:10.1177/
457 1077546314561282.
- 458 [10] H. Yamaguchi, Damping of transient vibration by a dynamic absorber, *Transactions of the Japan Society*
459 *of Mechanical Engineers Series C* 54 (499) (1988) 561–568. doi:10.1299/kikaic.54.561.
- 460 [11] P. Xiang, A. Nishitani, Optimum design and application of non-traditional tuned mass damper toward seis-
461 mic response control with experimental test verification, *Earthquake Engineering and Structural Dynamics*
462 44 (13) (2015) 2199–2220. doi:10.1002/eqe.2579.
- 463 [12] K. Williams, G. Chiu, R. Bernhard, Adaptive-passive absorbers using shape-memory alloys, *Journal of*
464 *Sound and Vibration* 249 (5) (2003) 835–848. doi:10.1006/jsvi.2000.3496.
- 465 [13] M. A. Savi, A. S. De Paula, D. C. Lagoudas, Numerical investigation of an adaptive vibration absorber
466 using shape memory alloys, *Journal of Intelligent Material Systems and Structures* 22 (1) (2011) 67–80.
467 doi:10.1177/1045389X10392612.

- 468 [14] F. Weber, C. Boston, M. Maslanka, An adaptive tuned mass damper based on the emulation of positive and
469 negative stiffness with an mr damper, *Smart Materials and Structures* 20 (1). doi:10.1088/0964-1726/
470 20/1/015012.
- 471 [15] S. Sun, J. Yang, W. Li, H. Deng, H. Du, G. Alici, T. Yan, An innovative mre absorber with double natural
472 frequencies for wide frequency bandwidth vibration absorption, *Smart Materials and Structures* 25 (5).
473 doi:10.1088/0964-1726/25/5/055035.
- 474 [16] S. B. Kumbhar, S. P. Chavan, S. S. Gawade, Adaptive tuned vibration absorber based on magnetorhe-
475 ological elastomer-shape memory alloy composite, *Mechanical Systems and Signal Processing* 100 (2018)
476 208–223. doi:10.1016/j.ymssp.2017.07.027.
- 477 [17] H. Xiuchang, S. Zhiwei, H. Hongxing, Optimal parameters for dynamic vibration absorber with negative
478 stiffness in controlling force transmission to a rigid foundation, *International Journal of Mechanical Sciences*
479 152 (2019) 88–98. doi:10.1016/j.ijmecsci.2018.12.033.
- 480 [18] T. D. Le, K. K. Ahn, Experimental investigation of a vibration isolation system using negative stiffness
481 structure, *International Journal of Mechanical Sciences* 70 (2013) 99–112. doi:10.1016/j.ijmecsci.
482 2013.02.009.
- 483 [19] X. Wang, H. Liu, Y. Chen, P. Gao, Beneficial stiffness design of a high-static-low-dynamic-stiffness vibration
484 isolator based on static and dynamic analysis, *International Journal of Mechanical Sciences* 142-143 (2018)
485 235–244. doi:10.1016/j.ijmecsci.2018.04.053.
- 486 [20] X. Sun, S. Zhang, J. Xu, Parameter design of a multi-delayed isolator with asymmetrical nonlinearity,
487 *International Journal of Mechanical Sciences* 138-139 (2018) 398–408. doi:10.1016/j.ijmecsci.2018.
488 02.026.
- 489 [21] Y. Wang, X. Jing, H. Dai, F. . Li, Subharmonics and ultra-subharmonics of a bio-inspired nonlinear isolation
490 system, *International Journal of Mechanical Sciences* 152 (2019) 167–184. doi:10.1016/j.ijmecsci.2018.
491 12.054.
- 492 [22] X. Shi, S. Zhu, Magnetic negative stiffness dampers, *Smart Materials and Structures* 24 (7) (2015) 072002.
493 doi:10.1088/0964-1726/24/7/072002.
- 494 [23] F. Zhang, S. Shao, Z. Tian, M. Xu, S. Xie, Active-passive hybrid vibration isolation with magnetic negative
495 stiffness isolator based on maxwell normal stress, *Mechanical Systems and Signal Processing* 123 (2019)
496 244–263. doi:10.1016/j.ymssp.2019.01.022.
- 497 [24] T. Mizuno, T. Toumiya, M. Takasaki, Vibration isolation system using negative stiffness, *JSME Interna-
498 tional Journal, Series C: Mechanical Systems, Machine Elements and Manufacturing* 46 (3) (2003) 807–812.
499 doi:10.1299/jsmec.46.807.
- 500 [25] Y. Shen, H. Peng, X. Li, S. Yang, Analytically optimal parameters of dynamic vibration absorber with
501 negative stiffness, *Mechanical Systems and Signal Processing* 85 (2017) 193–203. doi:10.1016/j.ymssp.
502 2016.08.018.

- 503 [26] I. A. Antoniadis, S. A. Kanarachos, K. Gryllias, I. E. Sapountzakis, Kdamping: A stiffness based
504 vibration absorption concept, *JVC/Journal of Vibration and Control* 24 (3) (2018) 588–606. doi:
505 10.1177/1077546316646514.
- 506 [27] X. Huang, Z. Su, H. Hua, Application of a dynamic vibration absorber with negative stiffness for control of a
507 marine shafting system, *Ocean Engineering* 155 (2018) 131–143. doi:10.1016/j.oceaneng.2018.02.047.
- 508 [28] S. Krenk, J. Høgsberg, Tuned mass absorber on a flexible structure, *Journal of Sound and Vibration* 333 (6)
509 (2014) 1577–1595. doi:10.1016/j.jsv.2013.11.029.
- 510 [29] K. Liu, J. Liu, The damped dynamic vibration absorbers: Revisited and new result, *Journal of Sound and*
511 *Vibration* 284 (3-5) (2005) 1181–1189. doi:10.1016/j.jsv.2004.08.002.
- 512 [30] S. Zhou, C. Jean-Mistral, S. Chesne, Electromagnetic shunt damping with negative impedances: Optimiza-
513 tion and analysis, *Journal of Sound and Vibration* 445 (2019) 188–203. doi:10.1016/j.jsv.2019.01.014.
- 514 [31] S. Chesne, C. Collette, Experimental validation of fail-safe hybrid mass damper, *JVC/Journal of Vibration*
515 *and Control* 24 (19) (2018) 4395–4406. doi:10.1177/1077546317724949.

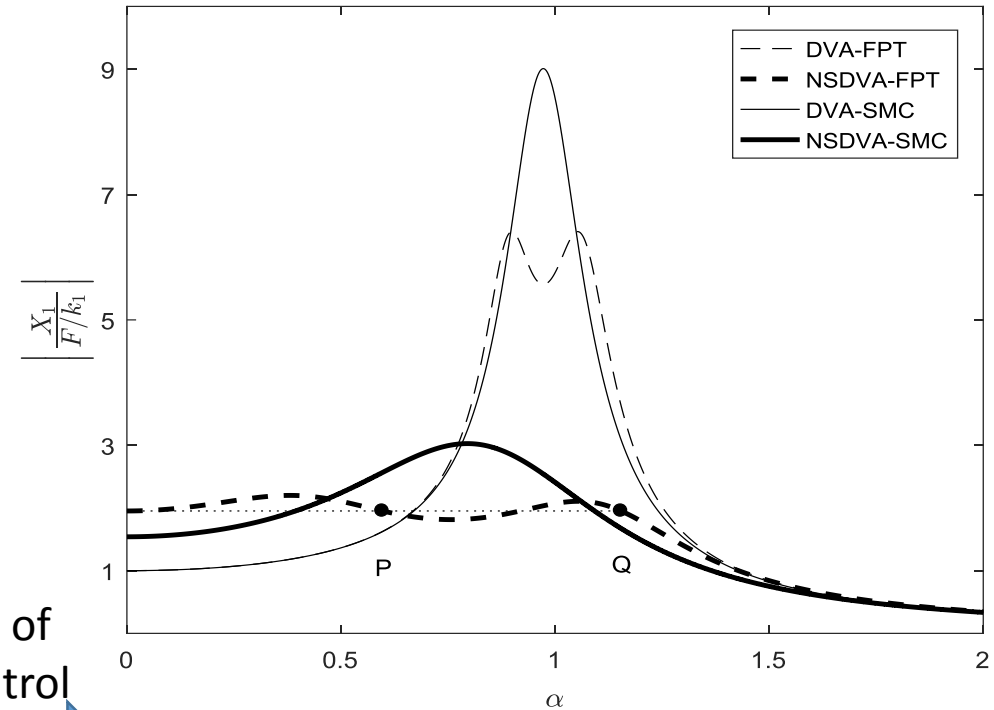
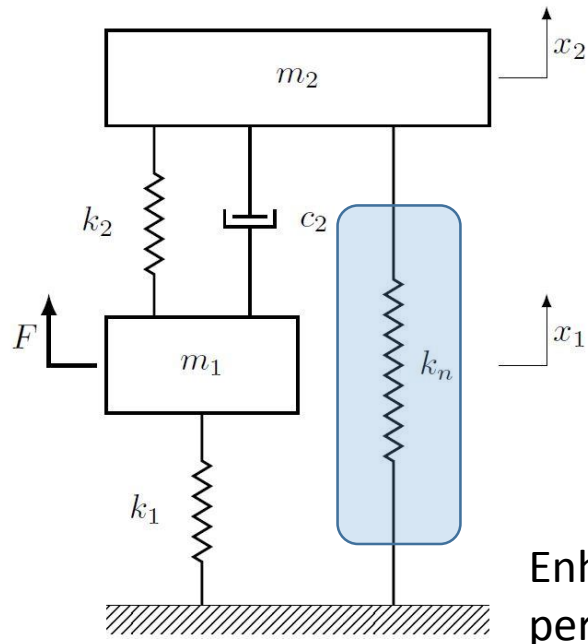
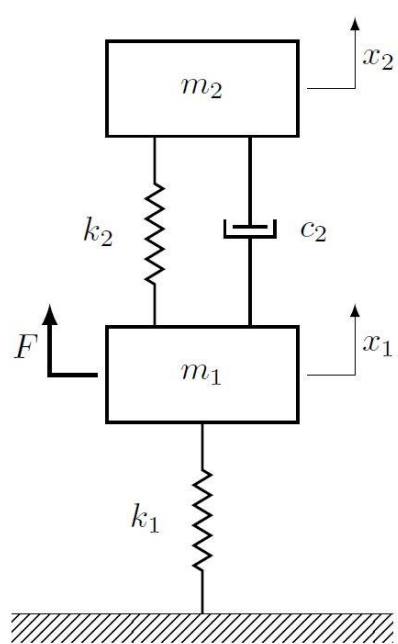

Enhanced performance of vibration control

Negative stiffness

DVAs

NSDVAs

