



**HAL**  
open science

# Improvement of the Performance of a Simple Box Model Using CFD Modeling to Predict Indoor Air Formaldehyde Concentration

Pierre Mocho, V. Desauziers, H. Plaisance, N. Sauvat

► **To cite this version:**

Pierre Mocho, V. Desauziers, H. Plaisance, N. Sauvat. Improvement of the Performance of a Simple Box Model Using CFD Modeling to Predict Indoor Air Formaldehyde Concentration. *Building and Environment*, 2017, 124, pp.450-459. 10.1016/j.buildenv.2017.08.033 . hal-02129457

**HAL Id: hal-02129457**

**<https://hal.science/hal-02129457>**

Submitted on 2 Nov 2023

**HAL** is a multi-disciplinary open access archive for the deposit and dissemination of scientific research documents, whether they are published or not. The documents may come from teaching and research institutions in France or abroad, or from public or private research centers.

L'archive ouverte pluridisciplinaire **HAL**, est destinée au dépôt et à la diffusion de documents scientifiques de niveau recherche, publiés ou non, émanant des établissements d'enseignement et de recherche français ou étrangers, des laboratoires publics ou privés.

# Improvement of the performance of a simple box model using CFD modeling to predict indoor air formaldehyde concentration

Pierre Mocho <sup>a, \*</sup>, Valérie Desauziers <sup>b</sup>, Hervé Plaisance <sup>b</sup>, Nicolas Sauvat <sup>c</sup>

<sup>a</sup> Laboratoire Thermique Energétique et Procédés, Université de Pau et des Pays de l'Adour, BP 7511, 64075 Pau, France

<sup>b</sup> Pôle RIME C2MA, IMT Mines d'Alès, Hélioparc, 2 Avenue Pierre Angot, 64053 Pau Cedex 9, France

<sup>c</sup> BOIS PE, GEMH, Université de Limoges, 30 Boulevard du Puy Nègre, 19300 Egletons, France

## A B S T R A C T

The purpose of this study is to improve the predictive potential of a simple box model by using CFD simulation. In this easy-use box model, the material/air mass transfer is governed by a convective coefficient of pollutant through the boundary layer settling on the surface of material ( $h_{oi}$ ) which is a key parameter for the prediction of indoor air pollution. The aim of this study is to better assess this parameter as function of several variables (material surface emissions, room configurations and ventilation conditions) by means of CFD simulations. First, dimensional analysis method is applied to CFD results to establish a new relationship between physical parameters involved in the transfer of compounds in air, particularly room characteristic length, mean air velocity in inlet section area and molecular diffusion of formaldehyde in air. Thus, the validity of this relation is tested by CFD modeling for large range of room sizes, mean air velocities and inlet section locations. Lastly, results of a first measurement campaign show the improvement of the prediction of the box model compared to the previous version including this new relation by a better assessment of indoor material contributions to indoor air formaldehyde concentration.

### Keywords:

Formaldehyde

Indoor air quality (IAQ)

Building material

Box model

Computational fluid dynamics (CFD)

modeling

## 1. Introduction

Exposure to indoor air pollutants can be considered as one of the primary environmental health stressors, since people spend 80–90% of their time within enclosed living spaces [1]. Among indoor pollutants, volatile organic compounds (VOCs) could be responsible for health hazards and/or malodorous atmospheres [2]. There is evidence of the increased prevalence of asthma and allergies within damp homes, especially in developed countries, among children [3,4]. It has been reported that more than a third of children in Europe has had bronchial asthma or allergy [5]. Indoor pollutants are released from a variety of sources as building materials, indoor activities or ambient air quality [6]. Formaldehyde is a common indoor air contaminant with adverse health effects. In 2010, the World Health Organization (WHO) recommend the use of the short-term (30-min) guideline of  $0.1 \text{ mg m}^{-3}$  will also prevent long-term health effects, including cancer. FA is genotoxic, causing DNA adduct formation, and has a clastogenic effect. Normal indoor

air FA concentrations do not pass beyond the respiratory epithelium, and therefore FA's direct effects are limited to portal-of-entry effects. However, systemic effects have been observed in rats and mice, which may be due to secondary effects as airway inflammation and (sensory) irritation of eyes and the upper airways, which inter alia decreases respiratory ventilation [7,8]. High-dose exposure increases the risk of acute poisoning, while prolonged exposure may lead to chronic toxicity and even cancer [9,10]. Numerous common building materials emit formaldehyde indoors. Among them, wood-based panels, which constitute the major elements of building components and furniture, have been paid special attention [11]. To investigate real material emissions, several analytical methods have been developed to obtain simpler and faster on-site sampling [12–17]. The ability to measure in situ the surface concentrations or emission rates of building materials offered new opportunities for IAQ modeling. Two major types of computer simulation techniques for modeling IAQ were currently applied: mass-balance models and computational fluid dynamics (CFD) techniques [18]. Mass-balance models were used to assess average indoor air pollutant concentration as a function of outdoor concentration, building characteristics (volume, air exchange rate ...)

\* Corresponding author.

E-mail address: pierre.mocho@univ-pau.fr (P. Mocho).

## Abbreviations

$A_j$	external surface area of the material $j$ ( $m^2$ )	$j$	material number
$C_i$	average indoor air concentration of the pollutant $i$ ( $\mu g.m^{-3}$ )	$L$	length of the room (m)
$C_{iout}$	average outdoor air concentration of pollutant $i$ ( $\mu g.m^{-3}$ )	$l$	width of the room (m)
$C_{sij}$	gas phase concentration of the pollutant $i$ at material $j$ surface ( $\mu g.m^{-3}$ )	$L_c$	characteristic length of the material/fluid system ( $m$ ) = $V/\Sigma A_j$
$D_{i,air}$	molecular diffusion of the pollutant $i$ in the air ( $m^2.s^{-1}$ )	$m$	total number of materials within the room
$F_{air}$	air flow ( $m^3.s^{-1}$ )	$Pe$	Peclet number
$H$	height of the room (m)	$Q_{ij}$	contribution of the material $j$ to the IAQ (source or sink of pollutant $i$ ) ( $\mu g.m^{-3}.s^{-1}$ )
$h_{ij}$	convective mass transfer coefficient of pollutant $i$ through the boundary layer over the material $j$ ( $m.s^{-1}$ )	$Sc$	Schmidt number
$h_{oi}$	an overall convective coefficient of the pollutant $i$ suitable for all boundary layers ( $m.s^{-1}$ )	$Sh$	Sherwood number
$i$	pollutant (formaldehyde)	$t$	time (s)
		$U$	mean air velocity in cross section area of inlet ( $m.s^{-1}$ )
		$V$	volume of the room ( $m^3$ )
		$\mu$	dynamic viscosity of the air ( $kg.m^{-1}.s^{-1}$ )
		$\rho$	density of the air ( $kg.m^{-3}$ )
		$\lambda$	outdoor air exchange rate ( $s^{-1}$ )

and indoor sources/sinks. To simplify the mathematical resolution, the indoor air space is considered as continuously stirred tank reactor (CSTR), operating at steady state conditions [19–21]. On the other hand, CFD models take into account the fluid flow strictly as well as the transport of indoor pollutants. Researchers have done much to promote the application of numerical simulation in air quality [22–27]. For example, Panagopoulos et al. (2011) adopted CFD technology to simulate the dispersion of VOC and formaldehyde in indoor air of an apartment [28]. The purpose of this study is to use CFD simulation to improve the predictive potential of a simple box model, detailed in a previous paper [29]. In this previous paper, the efficiency of this model was partially assessed due to the low contribution of building material emissions to indoor pollution. That will be the focus of the present paper using CFD modeling to simulate large range of material emissions and ventilation conditions in a room having a rectangular parallelepiped geometric form.

## 2. Theory/calculation

### 2.1. One-box model

A brief review of the model is made because it was detailed in a previous paper [29]. The simple one-box model (or single zone model) describes the change in pollutant concentration in a well-mixed room as a differential equation, in which production/loss processes add/subtract to the concentration over time. Pollutant mass balance in controlled volume (box) can be expressed by the following differential equation (Fig. 1):

$$\frac{\partial C_i}{\partial t} = \sum_{j=1}^m Q_{ij} + \lambda C_{iout} - \lambda C_i \quad (1)$$

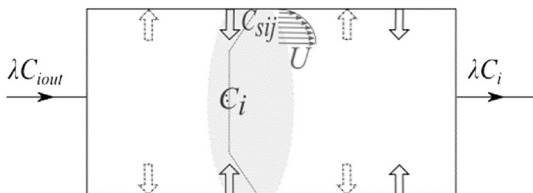

Fig. 1. Physical concept of the one-box model.

where  $C_i$  is the average indoor air concentration of the pollutant  $i$  ( $\mu g.m^{-3}$ ),  $Q_{ij}$  the contribution of the material  $j$  to the IAQ (source or sink of pollutant  $i$ ) ( $\mu g.m^{-3}.s^{-1}$ ),  $\lambda$  the outdoor air exchange rate ( $s^{-1}$ ),  $C_{iout}$  the average outdoor air concentration of pollutant  $i$  ( $\mu g.m^{-3}$ ),  $t$  the time and  $m$  the total number of materials within the room. In Fig. 1,  $C_{sij}$  is the gas phase concentration of the pollutant  $i$  at the material  $j$  surface.

At material/air interface, pollutant transport through the boundary layer could be expressed as:

$$Q_{ij} = h_{ij} \frac{A_j}{V} (C_{sij} - C_i) \quad (2)$$

where  $h_{ij}$  is the convective mass transfer coefficient of pollutant  $i$  through the air boundary layer on the surface of material  $j$ ,  $A_j$  the surface area of the material  $j$  and  $V$  the volume of the room.

Substituting (2) into (1) and at steady state, we obtain:

$$C_i = \frac{\sum_{j=1}^m h_{ij} \frac{A_j}{V} C_{sij} + \lambda C_{iout}}{\sum_{j=1}^m h_{ij} \frac{A_j}{V} + \lambda} \quad (3)$$

To simplify the calculation of the previous equation, an overall convective coefficient ( $h_{oi}$ ) of the pollutant  $i$  suitable for all boundary layers is defined. So equation (3) becomes:

$$C_i = \frac{\frac{h_{oi}}{V} \sum_{j=1}^m A_j C_{sij} + \lambda C_{iout}}{\frac{h_{oi}}{V} \sum_{j=1}^m A_j + \lambda} \quad (4)$$

When  $\lambda \rightarrow 0$  then  $C_i = \frac{\sum_{j=1}^m A_j C_{sij}}{\sum_{j=1}^m A_j}$

For low values of  $\lambda$ , the modeled concentration of the pollutant ( $C_i$ ) tends to the average of gas phase concentrations at material surface ( $C_{sij}$ ) weighted by material surfaces ( $A_j$ ).

### 2.2. Establishment of an empirical relationship to estimate an overall convective coefficient ( $h_{oi}$ )

An empirical relationship between  $h_{oi}$ ,  $\rho$ ,  $\mu$ ,  $D_{i,air}$ ,  $U$  and  $L_c$  is established and used to assess  $h_{oi}$ . This relationship is obtained by dimensional analysis, based on the application of Vaschy-Buckingham theorem [30]:

$$\frac{h_{oi}L_c}{D_{iair}} = K \left( \frac{\mu}{D_{iair}\rho} \right)^\alpha \left( \frac{UL_c}{D_{iair}} \right)^\beta \quad (5)$$

where  $L_c$  is the characteristic length of the material/fluid system (m) ( $= V/\Sigma A_j$ ),  $U$  the mean air velocity in cross section area of inlet ( $\text{m}\cdot\text{s}^{-1}$ ),  $\rho$  the density of the air ( $\text{kg}\cdot\text{m}^{-3}$ ),  $\mu$  the dynamic viscosity of the air ( $\text{kg}\cdot\text{m}^{-1}\cdot\text{s}^{-1}$ ) and  $D_{iair}$  the molecular diffusion of formaldehyde in the air ( $\text{m}^2\cdot\text{s}^{-1}$ ). The characteristic length takes into account the room dimensions (volume, material surface areas). To assess an overall convective coefficient, it is essential to introduce a fluid velocity parameter. The easily quantifiable parameter is the mean air velocity in cross section area of inlet. So it will be tested as convective parameter in input data of the established relationship.

Three dimensionless numbers are obtained, respectively known as Sherwood number ( $Sh$ ) ( $\frac{h_{ijm}L_c}{D_{iair}}$ ), Schmidt number ( $Sc$ ) ( $\frac{\mu}{D_{iair}\rho}$ ) and Peclet number ( $Pe$ ) ( $\frac{UL_c}{D_{iair}}$ ). Schmidt number has a constant value for formaldehyde ( $=0.8945$ ). So, there are only two parameters to identify ( $K$  and  $\beta$ ). To determine these parameters, CFD simulations are carried out for air flow rate ( $F_{air}$ ) range of about  $10\text{--}140\text{ m}^3\text{ h}^{-1}$  (or  $U$  between  $0.19$  and  $2.63\text{ m}\cdot\text{s}^{-1}$ ) on a room taken as a reference in this study, described in Table 1.

### 2.3. CFD modeling

ANSYS Fluent R15.0 software (Canonsburg, USA) is used to simulate fluid dynamics inside the experimental site. Based on Navier–Stokes equations, it solves both mass and momentum conservation equations using finite-volume method. Simulations are performed with viscous realizable k-epsilon model.

## 3. Material and methods

As shown previously in the box model description, the material/air mass transfer is based on the determination of an overall convective mass transfer coefficient ( $h_{oi}$ ). This point is now discussed in the next section.

### 3.1. Determination of an overall convective mass transfer coefficient ( $h_{oi}$ )

The applied methodology involves determining the average concentration of formaldehyde ( $C_i$ ) in a reference room (Table 1) by CFD modeling and then to introduce this value into the box model (Eq. (4)) to deduce the overall convective coefficient ( $h_{oi}$ ) from it, according to the following equation:

$$h_{oi} = \frac{\lambda V (C_i - C_{iout})}{\sum_{j=1}^m (A_j C_{sij}) - C_i \sum_{j=1}^m A_j} \quad (6)$$

Main characteristics of the reference room are summarized in Table 1.

Nomenclature of four walls, floor and ceiling of this room is

detailed in Fig. 2.

Air inlet and outlet are located on the same wall, named front wall. Areas of all the indoor surfaces are reported on Table 2.

In a room, all building materials have different emission profiles which are subject to different local air velocities. So it is fundamental to study the relevance of defining an overall convective coefficient instead of local coefficients. The aim of this part is to investigate the effect of material surface concentration ( $C_{sij}$ ) on overall convective coefficient calculated by Eq. (6) ( $h_{oi}$ ). A large range of concentration values is chosen to examine the ability to define an overall coefficient suitable for all cases. For this purpose, CFD simulations are implemented basing on data reported on Table 3.

### 3.2. Effect of air flow rate on the estimation of an overall convective coefficient ( $h_{oi}$ )

To test the air flow effect on  $h_{oi}$  value, CFD simulation is carried out for a range of air flow stream ( $F_{air}$ ) from  $10$  to  $140\text{ m}^3\text{ h}^{-1}$  inside the room, which corresponds to an inlet air velocity in cross section area ( $U$ ) between  $0.191$  and  $2.62\text{ m}\cdot\text{s}^{-1}$ . Average indoor air concentration of formaldehyde ( $C_i$ ) assessed from CFD calculation is then introduced into the box model to deduce the overall convective coefficient ( $h_{oi}$ ) from it. A value of gas phase concentration of formaldehyde at material surface ( $C_{sij}$ ) equal to  $300\text{ }\mu\text{g}\cdot\text{m}^{-3}$  is applied to all faces of the room, detailed in Table 1, as input data of the CFD model. This scenario of high concentration is chosen because it leads to a maximal divergence of both CFD and box models. Obtained results are analyzed by R-3.2.1 software (<https://cran.r-project.org/bin/windows/base/>) applying regression analysis, based on non-linear least squares method, to assess to  $K$  and  $\beta$  parameters of the relationship established previously (Eq. (5)).

### 3.3. Effect of room size on the estimation of $h_{oi}$

Various CFD simulations are carried out to test the influence of the geometrical size on the estimation of the overall convective

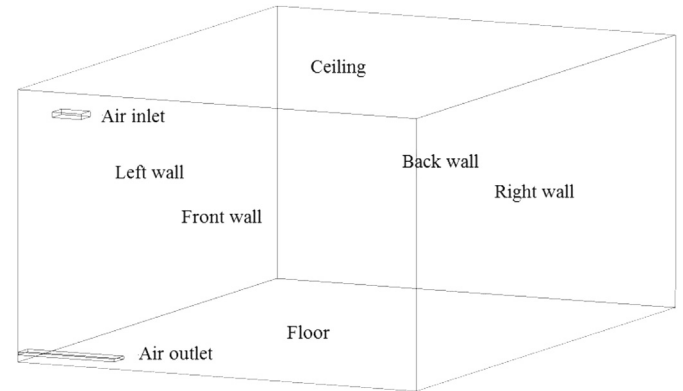

Fig. 2. Nomenclature of four walls, floor and ceiling inside the studied room.

**Table 1**  
Ventilation rate and dimensions of the reference room.

Length $L$ (m)	5.5
Width $l$ (m)	4.0
Height $H$ (m)	2.5
Volume $V$ ( $\text{m}^3$ )	55
Cross section area of air inlet ( $\text{m}^2$ )	0.0145 ( $0.29 \times 0.05$ )
Cross section area of air outlet ( $\text{m}^2$ )	0.02509 ( $0.965 \times 0.026$ )
Air flow $F_{air}$ ( $\text{m}^3\cdot\text{s}^{-1}$ )	$1.52778 \times 10^{-2}$
Mean air velocity in cross section area of Inlet $U$ ( $\text{m}\cdot\text{s}^{-1}$ )	1.0536

**Table 2**  
Surface area of the six faces of the studied room.

Face	Surface area (m <sup>2</sup> )
Front wall	9.9604
Back wall	10
Right wall	13.75
Left wall	13.75
Floor	22
Ceiling	22

**Table 3**  
Studied cases to estimate an overall coefficient ( $h_{oi}$ ).

Gas phase concentration of formaldehyde at material surface $C_{sij}$ ( $\mu\text{g}\cdot\text{m}^{-3}$ )					
Floor	Ceiling	Right wall	Left wall	Front wall	Back wall
300	300	300	300	300	300
300	300	300	300	0	0
300	300	0	0	0	0
300	0	0	0	0	0
150	150	150	150	150	150
150	150	150	150	0	0
150	150	0	0	0	0
150	0	0	0	0	0
75	75	75	75	75	75
75	75	75	75	0	0
75	75	0	0	0	0
75	0	0	0	0	0
30	30	30	30	30	30
30	30	30	30	0	0
30	30	0	0	0	0
30	0	0	0	0	0
300	30	150	75	30	30
30	300	30	150	75	30
30	30	300	30	150	75
75	30	30	300	30	150
150	75	30	30	300	30
30	150	75	30	30	300

coefficient ( $h_{oi}$ ). Obtained values are compared to those deduced from the relationship (Eq. (5)) to assess the applicability of this relationship. Set of experimental conditions are reported on Table 4. Experiments lead to a room volume varying from 30 to 120 m<sup>3</sup>. Locations and cross section areas of air inlet, outlet and air flow rate remain identical to those presented in Table 1. A value of gas phase concentration of formaldehyde at material surface ( $C_{sij}$ ) equal to 300  $\mu\text{g}\cdot\text{m}^{-3}$  is applied to all faces of the room as input data of CFD simulations.

Next paragraph concerns the effect of mean air velocity in the cross section area of inlet ( $U$ ) on the estimation of the overall convective coefficient ( $h_{oi}$ ).

**Table 4**  
Studied cases to test the effect of geometrical size of the room on the estimation of the overall convective coefficient ( $h_{oi}$ ).

N° CFD sim	$L_c$ (m)	Geometrical size $L \times l \times H$			Face surface area (m <sup>2</sup> )					
		$L$ (m)	$l$ (m)	$H$ (m)	Floor	Ceiling	Right wall	Left wall	Front wall	Back wall
1	0.5088	3	4	2.5	12	12	7.5	7.5	9.96	10
2	0.5559	4	4	2.5	16	16	10	10	9.96	10
3	0.5885	5	4	2.5	20	20	12.5	12.5	9.96	10
4	0.6125	6	4	2.5	24	24	15	15	9.96	10
5	0.6308	7	4	2.5	28	28	17.5	17.5	9.96	10
6	0.6454	8	4	2.5	32	32	20	20	9.96	10
7	0.6524	6	5	2.5	30	30	15	15	12.46	12.5
8	0.682	6	6	2.5	36	36	15	15	14.96	15
9	0.7049	6	7	2.5	42	42	15	15	17.46	17.5
10	0.7231	6	8	2.5	48	48	15	15	19.96	20

### 3.4. Effect of geometrical size of cross section area of air inlet on the estimation of $h_{oi}$

To test the relevance of air velocity in inlet section ( $U$ ) as convective parameter to assess  $h_{oi}$ , the effect of the size of cross section area on  $h_{oi}$  keeping a same air flow rate is now investigated.

Four CFD calculations corresponding to three different cross section areas of air inlet, leading to mean velocity ( $U$ ) varying from 0.5 to 2.6 m s<sup>-1</sup>, are carried out according to data detailed on Table 5. Studied room is always the one described in Table 1, with a location of the inlet and outlet sections identical to that shown in Fig. 2.

Last paragraph deals with the effect of the location of air inlet/outlet sections on the estimation of  $h_{oi}$ .

### 3.5. Effect of the location of air inlet/outlet sections on the estimation of $h_{oi}$

Until now in this study, air inlet and outlet section areas are located in the same face as shown in Fig. 2. Two new locations of air inlet/outlet are now studied according to Fig. 3. The outlet is moved from the front wall to the back wall. Geometry sizes of the room and air flow rate are always identical to that detailed in Table 1.

### 3.6. Comparison of $h_{oi}$ values deduced from both CFD simulations and established relationship for a room of a newly-built wood frame house

The model in CFD simulation is a wood frame room. In order to assess the domain of applicability of the relationship, the room with a geometry quite different from a simple rectangular box shape is studied (Fig. 4). Materials and areas of all indoor surfaces are listed in Table 6. Interior walls (1 and 2) are differentiated because they are not composed of the same assembly of materials. Room volume ( $V$ ) and its characteristic length ( $L_c$ ) are equal to 27.715 m<sup>3</sup> and 0.466 m, respectively. Air inlet and outlet have respectively cross section area of 0.0145 m<sup>2</sup> (0.29 m  $\times$  0.05 m) and 0.0251 m<sup>2</sup> (0.965 m  $\times$  0.026 m).

**Table 5**  
Studied cases to assess the effect of mean air velocity in cross section area of inlet ( $U$ ) on the estimation of the overall convective coefficient ( $h_{oi}$ ).

N° CFD sim	Air inlet section			Air velocity $U$ (m.s <sup>-1</sup> )
	Length (m)	Width (m)	Area (m <sup>2</sup> )	
11	0.29	0.1	0.029	0.5268
12	0.29	0.03	$8.7 \times 10^{-3}$	1.756
13	0.29	0.02	$5.8 \times 10^{-3}$	2.634
14	0.145	0.04	$5.8 \times 10^{-3}$	2.634

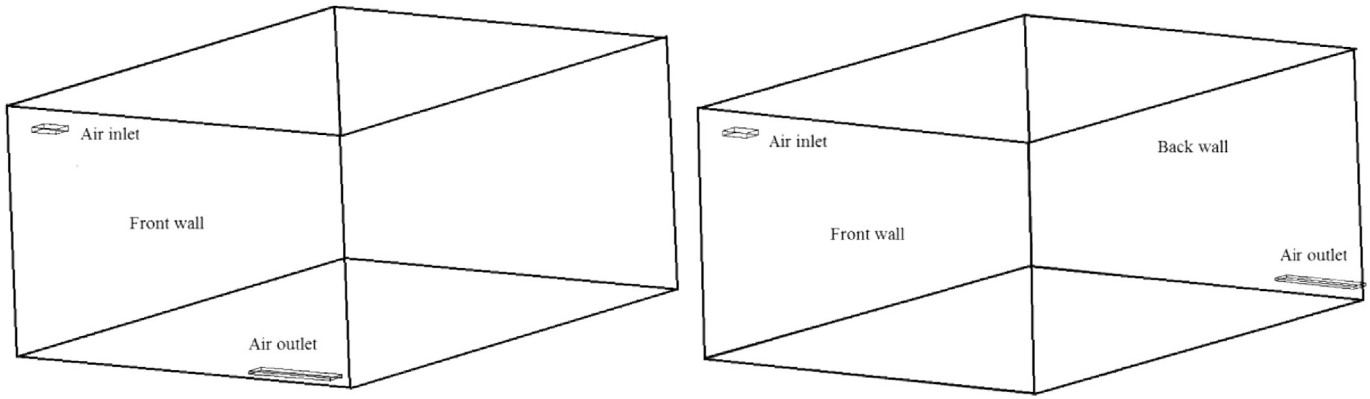

Fig. 3. Two new locations of air inlet/outlet.

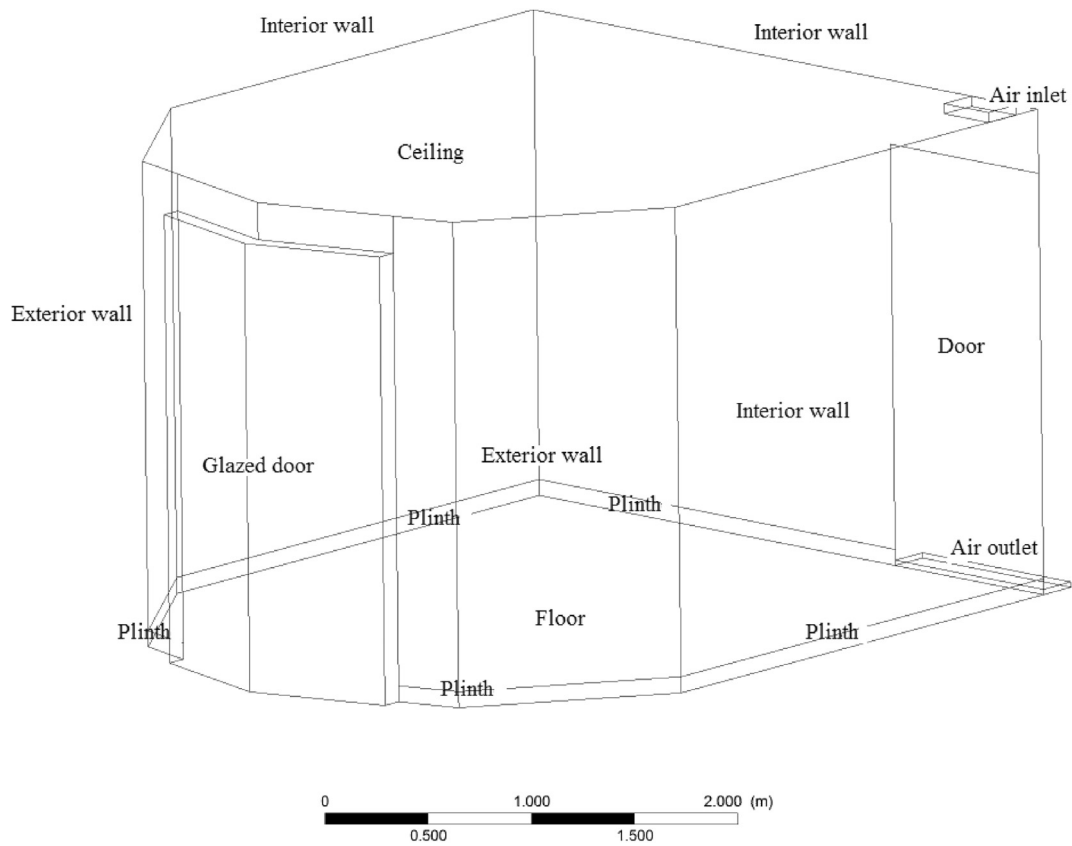

Fig. 4. Plan of the studied room.

Table 6

Surface material component and surface area of each face of the studied room (real case).

Face	Component	Surface area (m <sup>2</sup> )
Interior wall 1	Painted gypsum board	18.02
Interior wall 2	Painted gypsum board	7.62
Floor	Plywood (vitrified ash)	11.46
Ceiling	Painted gypsum board	11.335
Glazed door	Glass	3.35
Door	Maritime pin + cellulose varnish	2
Plinths	Medium-density fiberboard	0.854

A gas phase concentration of formaldehyde at material surface ( $C_{sij}$ ) of  $300 \mu\text{g m}^{-3}$  is applied to seven faces of the room as input data of CFD model. Formaldehyde concentration in air inlet is fixed to  $5 \mu\text{g m}^{-3}$ . CFD simulations are carried out for air flow rate ( $F_{air}$ ) range of about  $10\text{--}63 \text{ m}^3 \text{ h}^{-1}$  (10, 21, 42, 55 and  $63 \text{ m}^3 \text{ h}^{-1}$ ). Convective coefficient values ( $h_{oi}$ ) deduced from both CFD simulation and established relation (Eq. (5)) is compared to assess the applicability of this new version of box model.

### 3.7. Real case study based on an experimental campaign

The aim of the study is to test performances of both models (CFD, box model) to predict average indoor air concentration of

formaldehyde in the room detailed previously (Fig. 4.). To this end, a measurement campaign is carried out on the experimental site, described in the previous 3.6 section. The methods for the measurements of formaldehyde concentrations in air and at indoor material surfaces, as well as that used for the air exchange rate assessment were detailed in a previous paper [29]. Air sampling is performed in 250 mL glass vial (Entech Instruments, Simi Valley, CA, USA) equipped with SPME-adapter (Quad Service, Achères, France). On site, vials are filled with air by simply opening their vacuum valves and then stored no longer than two days at room temperature ( $20 \pm 3$  °C). At laboratory, a pre-conditioned and modified SPME fiber is directly introduced in the vial through the SPME-adapter. The pre-concentration of formaldehyde is carried out for 30 min. The fiber is then introduced in a PTV injection port of a 3800 gas chromatograph coupled with a 1200Q quadrupole mass spectrometer (GC-MS) (Varian, Les Ulis, France) for quantification. To quantify material surface concentration, the sampling involved two steps: first, a home-made cylindrical glass emission cell equipped with a septum is directly placed on the material surface and formaldehyde released from the material to the headspace of the cell until reaching equilibrium (about 2 h). Second, a pre-conditioned modified SPME fiber is introduced during 15 min for formaldehyde pre-concentration before GC-MS analysis.

### 3.8. CFD simulation methodology

CFD models concern a microscopic view of IAQ by examining the detailed flow fields and formaldehyde concentration distribution within a room. Implementation of this tool may lead to a more accurate average indoor air concentration of formaldehyde ( $C_i$ )

**Table 7**  
Main parameters of CFD simulation of the reference room detailed on Table 1.

Materials	
Mixture	Formaldehyde-air
Density	Incompressible ideal gas
Thermal conductivity ( $W.m^{-1}.K^{-1}$ )	0.026
Viscosity (Pa.s)	$1.8 \times 10^{-5}$
Formaldehyde diffusivity ( $m^2.s^{-1}$ )	$1.67 \times 10^{-5}$
Meshing	
Meshing method	Multizone
Mesh type	Hexahedral
Nodes	331,222
Elements	320,310
Element size min-max ( $m^3$ )	$3.017 \times 10^{-6}$ – $5.617 \times 10^{-4}$
Element face min-max ( $m^2$ )	$1.251 \times 10^{-4}$ – $8.041 \times 10^{-3}$
Mesh quality	
Minimum orthogonal quality	0.372
Maximum aspect ratio	31.12
Inflation	
Limits	6 faces (4 walls, floor, ceiling)
Inflation option	Total thickness
Number layer	5
Growth rate	1.2
Maximum thickness (m)	0.055
CFD Fluent	
Model	Viscous Realizable k-epsilon
Discretization	
Gradient	Least square cell based
Pressure	Second order upwind
Momentum	Second order upwind
Formaldehyde	Second order upwind
Energy	Second order upwind
Solution method	
Solution method	Coupled
Boundary conditions	
Inlet velocity ( $m.s^{-1}$ )	1.0536
Formaldehyde concentration ( $\mu g.m^{-3}$ )	
Inlet	5
6 faces	300

required to then assess the convective coefficient ( $h_{oi}$ ) using Eq. (6). As an example, main parameters for CFD simulation of the room detailed in Table 1 are summarized in Table 7.

## 4. Results and discussion

### 4.1. Determination of an overall convective mass transfer coefficient ( $h_{oi}$ ) using CFD modeling

The purpose of this section is to assess the relevance of defining an overall convective coefficient ( $h_{oi}$ ) instead of local coefficients to quantify the material/air mass transfer. Stringent conditions with a large range of material surface concentrations are chosen to analyze the ability to define an overall coefficient suitable for all cases (Table 3). For this, CFD modeling is used to calculate average indoor air concentration of formaldehyde ( $C_i$ ) in the reference room (Table 1) and then this value is introduced in the box model to deduct the convective coefficient according to Eq. (6). The mean value of  $h_{oi}$  deduced from the 22 simulations detailed on Table 3 is equal to  $1.3 \times 10^{-3} m s^{-1}$  with a standard deviation of  $0.3 \times 10^{-3} m s^{-1}$ . To simplify the determination of an overall coefficient, this value can be assessed from the maximum value of indoor air concentration ( $C_i = 267 \mu g m^{-3}$ ) resulting of simulation data where a gas phase concentration of formaldehyde at material surface ( $C_{sij}$ ) of  $300 \mu g m^{-3}$  is applied to all faces of the room. Then, the overall coefficient ( $h_{oi}$ ) is  $1.3 \times 10^{-3} m s^{-1}$ . Comparison of indoor air concentrations obtained by CFD modeling (reference method) and box model using this overall coefficient value ( $1.3 \times 10^{-3} m s^{-1}$ ) is presented in Fig. 5.

Uncertainties in indoor air concentrations of box and CFD models ( $\Delta C_i/C_i$ ) are respectively assessed to 0.03 with the only contribution of  $h_{oi}$  standard deviation and 0.005 by repeating 10 runs. Results of the “exact” CFD model with an average value equal to  $83.2 \mu g m^{-3}$  are close to the first bisector of the figure. Values of the box model are distributed according to the Laplace-Gauss normal law distribution, with average and standard deviation respectively equal to 81.3 and  $63.4 \mu g m^{-3}$ . According to the Student t-test, there is no significant difference between the results of two models at the 95% confidence level.

So, this study shows the applicability of an overall convective coefficient ( $h_{oi}$ ) integrated in a box model suitable for a large range of material surface concentrations ( $C_{sij}$ ). This result is consistent with diffusion models in which the convective coefficient is only dependent on local air flow rate inside the boundary layer at material/air interface and not on surface concentrations.

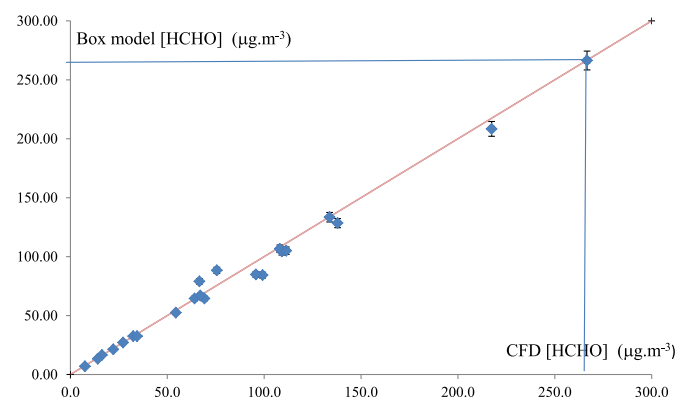

**Fig. 5.** Comparison of CFD model (reference value) and box model with an overall coefficient  $h_{oi}$  (mean value) resulting of simulation data (Table 3).

#### 4.2. Establishment of an empirical relationship to estimate an overall convective coefficient ( $h_{oi}$ ) by dimensional analysis

To obtain this relationship, CFD simulations are carried out for air flow rate ( $F_{air}$ ) range of about 10–140  $\text{m}^3 \text{h}^{-1}$  (or  $U$  between 0.19 and 2.63  $\text{m s}^{-1}$ ) in a reference room described in Table 1. Schmidt number being equal to 0.8945 for formaldehyde, we end up with the following simplified relationship between  $Sh$  and  $Pe$  numbers, deduced from Eq. (5):  $Sh = K'Pe^\beta$ . Study results are presented in Fig. 6.

$K'$  and  $\beta$  parameters are assessed by regression analysis. So, the convective coefficient ( $h_{oi}$ ) can be evaluated from the following relationship expressed as:

$$Sh = 0.04266Pe^{0.66502} \quad (7)$$

It is now important to test the robustness and applicability of this relationship for various room sizes.

#### 4.3. Study of the effect of room size on the estimation of $h_{oi}$

This relationship is established with the variation of only one parameter  $U$  in the Peclet number. The effect of characteristic length of material/fluid system ( $L_c$ ) on this relationship is now investigated. To study its effect, experiments are carried out in a large range of room volume from 30 to 120  $\text{m}^3$  with a constant value of air flow stream (55  $\text{m}^3 \text{h}^{-1}$ ) to neglect the influence of mean air velocity in cross section area ( $U$ ) in this part. Setting of study are detailed in section 3.3. Results are reported in Fig. 7.

Its observation shows a quite good correlation between the experimental points and empirical relationship. So this relationship is suitable to evaluate the effect of characteristic length ( $L_c$ ) on the determination of convective coefficient ( $h_{oi}$ ). However, small value of  $L_c$  leads to an underestimation of  $h_{oi}$  by relationship due to a high air exchange rate in this case (1.83  $\text{h}^{-1}$ ). In the range of air exchange (from 0.46 to 1.83  $\text{h}^{-1}$ ) studied in this part, the local air flow rate inside the room has a low impact on the estimation of  $h_{oi}$ . Furthermore, the choice of mean air velocity in cross section area ( $U$ ), constant value equal to 1.05  $\text{m s}^{-1}$  here, seems to be a relevant parameter to estimate  $h_{oi}$ . The effect of  $U$  on the estimation of  $h_{oi}$  will be more investigated in the next section.

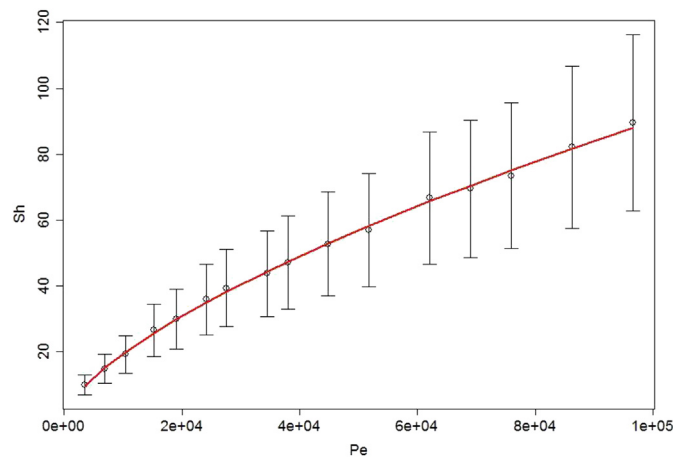

Fig. 6. Empirical relationship between Sherwood and Peclet numbers deduced from dimensional analysis.

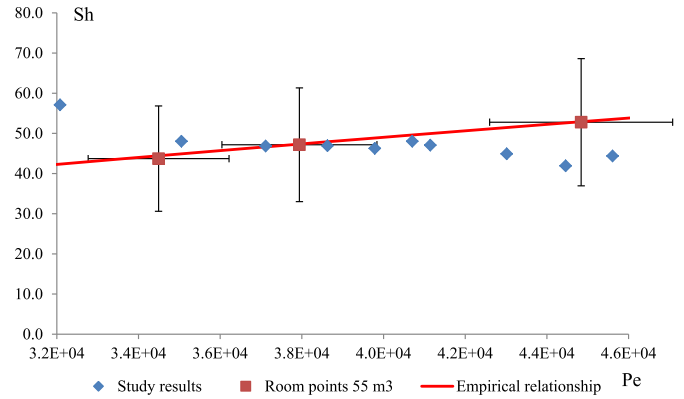

Fig. 7. Effect of room size on the assessment of convective coefficient ( $h_{oi}$ ) – Comparison between study results and empirical relationship (Eq. (7)).

#### 4.4. Effect of mean air velocity in cross section area ( $U$ ) on the estimation of $h_{oi}$

To discuss the relevance of  $U$  as convective parameter in Peclet number, a constant air flow stream of 55  $\text{m}^3 \text{h}^{-1}$  in a reference room (Table 1, Fig. 2) is applied to the four CFD simulations with various inlet section areas to obtain a large range of mean air velocities (from 0.53 to 2.63  $\text{m s}^{-1}$ ). Results are presented on Fig. 8.

This figure shows the influence of  $U$  on the quantification of  $h_{oi}$ . For high Peclet number ( $Pe$ ), the relationship (Eq. (7)) leads to an overestimation of the convective coefficient. But according to uncertainties, the assessment of  $h_{oi}$  from the relationship remains acceptable. Concerning the fluid dynamics process, this study highlights the effect of  $U$  on the determination of  $h_{oi}$ . So it seems not necessary to investigate the local air flow velocities at material/air interface inside the room to evaluate a mean convective coefficient. This surprising result could be explained by the local air flow stream values quite homogeneous, and then the knowledge of the maximum flow stream value at air inlet, corresponding to the mean air velocity in cross section area ( $U$ ), is sufficient to approximate  $h_{oi}$  value. To illustrate that, distribution of local flow velocities inside the studied room is presented on Fig. 9.

Despite an outdoor air exchange rate of 1  $\text{h}^{-1}$ , flow velocities are mainly lower than 0.1  $\text{m s}^{-1}$  inside this room, with the exception of the air supply area. The feasibility of replacing the local air flow velocities at material/air interface inside the room by a simple mean air velocity in cross section area ( $U$ ) is a major improvement in the aim of simplification of IAQ modeling approach.

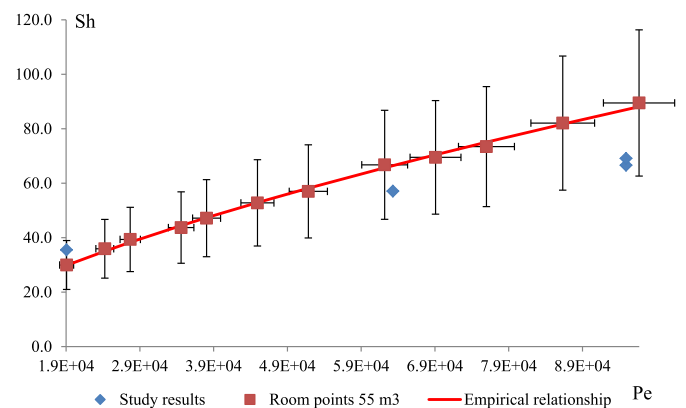

Fig. 8. Effect of mean air velocity in cross section area ( $U$ ) on the assessment of convective coefficient ( $h_{oi}$ ) – Comparison between study results and empirical relationship (Eq. (7)).



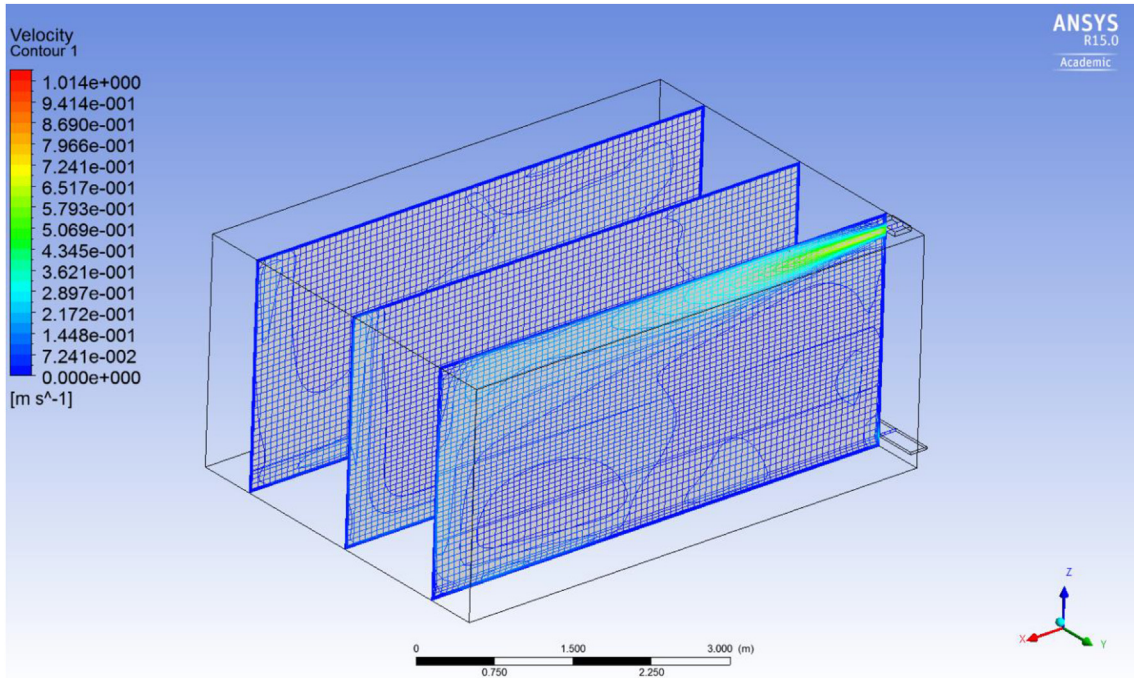

Fig. 9. Contours of velocity magnitude of air stream inside the room (volume 55 m<sup>3</sup>) -inlet flow rate 55 m<sup>3</sup> h<sup>-1</sup>.

4.5. Effect of the location of air inlet/outlet sections on the estimation of  $h_{oi}$

Until now, the study is based on a unique configuration of air inlet/outlet locations following the plan of Fig. 2. Two other configurations are tested to investigate the influence of this parameter on the applicability of the new relationship, according to the plan of Fig. 3. The room reference is always those detailed in Table 1. Results of the two CFD simulations are shown in Fig. 10.

According to these results, there is no significant effect of

location on the estimation of the convective coefficient. Consequently, the distribution of local flow velocities inside the room is not affected by the location of outlet section.

4.6. Discussion about the applicability of the new version of box model in a real case

In order to test the prediction limit of box model, the studied real room has geometry quite different from a simple rectangular box shape as shown in Fig. 4. Operating conditions are previously

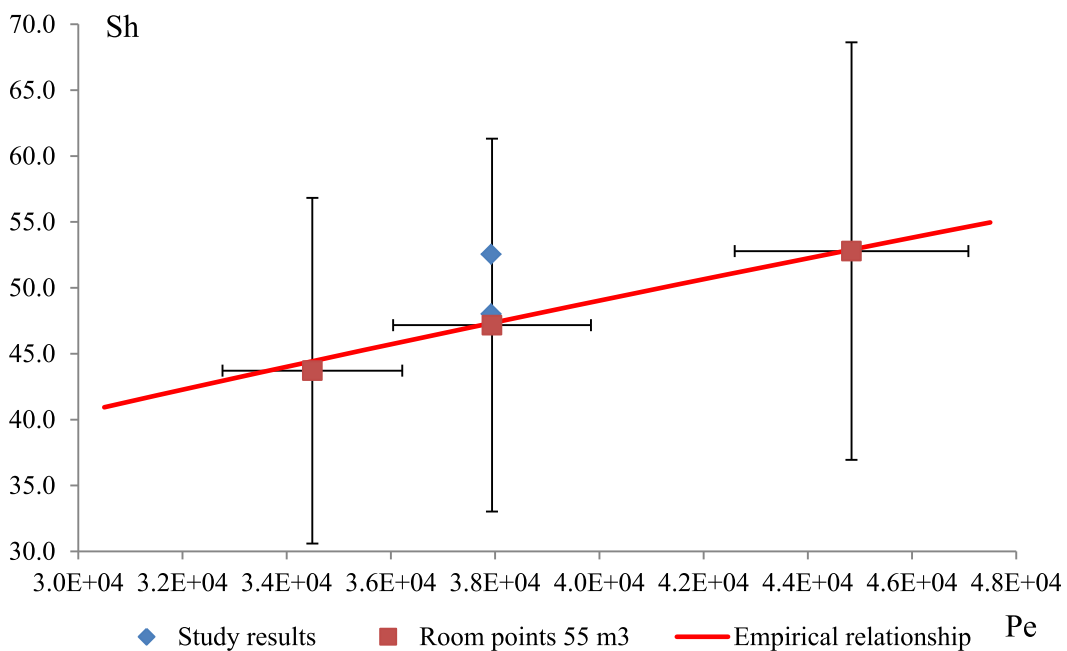
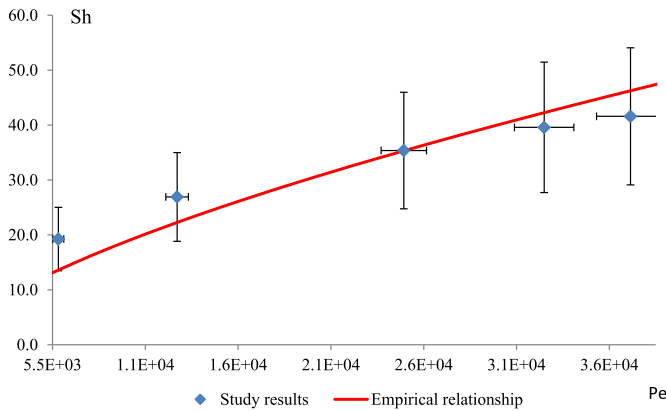

Fig. 10. Effect of the location of air inlet/outlet sections on the assessment of convective coefficient ( $h_{oi}$ ) – Comparison between study results and empirical relationship (Eq. (7)).



**Fig. 11.** Comparison between empirical relationship and CFD simulations applied to a real case (no rectangular box shape).

detailed on section 3.6. Comparison between CFD simulations and box model based on empirical relationship is summarized on Fig. 11.

Despite this difference of geometry, a quite good correlation between the two models can be observed, which is a promising result for the applicability of this simple box model. Until now, the study consisted in adjusting the box model by CFD simulations without experimental validation. This validation approach will be implemented in the next section.

#### 4.7. Measurement campaign and models test

Main results of the measurement campaign are summarized in Table 8 and modeling results reported in Table 9.

Data of Table 9 highlights an improvement of prediction of mean indoor air concentration with the new version of box model (experiment  $8.3 \mu\text{g m}^{-3}$  and  $8.1$  for the model) due to the integration of the new empirical relationship (Eq. (7)). Moreover, we observe an improvement of the predictive potential of box model due to the best prediction of convective coefficient value. The

**Table 8**  
Main results of campaign measurement.

Mean air velocity cross section area inlet ( $U$ ) ( $\text{m}\cdot\text{s}^{-1}$ )	0.402
Outdoor air exchange rate ( $\lambda$ ) ( $\text{s}^{-1}$ )	$2.1 \times 10^{-4}$
Outdoor air concentration of formaldehyde ( $C_{iout}$ ) ( $\mu\text{g}\cdot\text{m}^{-3}$ )	$3.2 \pm 2.3$
<b>Surface building materials</b>	<b>Interface concentration (<math>C_{sij}</math>) (<math>\mu\text{g}\cdot\text{m}^{-3}</math>)</b>
Floor	$6.8 \pm 1.1$
Ceiling	$5.9 \pm 0.9$
Interior wall	$13.7 \pm 2.2$
Exterior wall	$6.6 \pm 1.0$
Plinth	$8.0 \pm 1.3$
Door	$9.8 \pm 1.6$
Glazed door	$3.2 \pm 0.5$
<b>Formaldehyde indoor concentration (<math>C_i</math>) (<math>\mu\text{g}\cdot\text{m}^{-3}</math>)</b>	<b><math>8.3 \pm 2.3</math></b>

**Table 9**  
Comparison between experimental and modeling results.

Formaldehyde indoor air concentration ( $C_i$ ) ( $\mu\text{g}\cdot\text{m}^{-3}$ )			
Experimental	CFD model	Box model new version	Box model old version
$8.3 \pm 2.3$	$8.0 \pm 0.4$	$8.1 \pm 5.5$	$4.9 \pm 4.3$

relationship to assess  $h_{oi}$  used in the old version of box model leads to an underestimation of the material emission contribution to indoor air concentration.

## 5. Conclusion

In this paper, CFD simulations are implemented to improve the performance of a simple box model by testing large range of material surface concentrations and ventilation conditions in a room of rectangular parallelepiped geometric form.

This study highlights the interest of mean air velocity in cross section area of inlet ( $U$ ) as adjustment parameter of air ventilation in indoor environment to assess an overall convective coefficient of formaldehyde suitable for all boundary layers at indoor material surfaces ( $h_{oi}$ ).

An empirical relationship between  $h_{oi}$ ,  $\rho$ ,  $\mu$ ,  $D_{iair}$ ,  $U$  and  $L_c$  is established to estimate  $h_{oi}$  (Eq. (7)) and tested by CFD simulations for various room sizes, mean air velocities and air inlet section locations. Simulation results show a quite good correlation between CFD and empirical approaches.

Results of measurement campaign highlight the relevance of the new version of box model to assess average indoor air concentration of formaldehyde ( $C_i$ ) due to the best determination of  $h_{oi}$  with the established relationship. Given this first result, this new version of box model seems to be a convenient and easy-use tool to estimate the contribution of formaldehyde material emissions on indoor air quality. However, it will be necessary to realize more measurement campaigns to estimate the real performance of this new model.

## Acknowledgements

The project partners thank ADEME for financial support through the CORTEA program.

## References

- [1] N.E. Klepeis, An introduction to the indirect exposure assessment approach: modeling human exposure using microenvironmental measurements and the recent National Human Activity Pattern Survey, Environ. Health Persp 107 (1999) 365–374.
- [2] W. Ye, X. Zhang, J. Gao, G. Cao, X. Zhou, X. Su, Indoor air pollutants, ventilation rate determinants and potential control strategies in Chinese dwellings: a literature review, Sci. Total Environ. 586 (2017) 696–729.
- [3] H. Choi, N. Schmidbauer, C.G. Bornehag, Volatile organic compounds of possible microbial origin and their risks on childhood asthma and allergies within damp homes, Environ. Int. 98 (2017) 143–151.
- [4] J. Lotvall, L. Ekerljung, E. Ronmark, G. Wennergren, A. Linden, E. Ronmark, West Sweden Asthma Study: prevalence trends over the last 18 years argues no recent increase in asthma, Respir. Res. 10 (2009) 94–104.
- [5] M.I. Asher, H.R. Anderson, A.W. Stewart, J. Crane, N. Ait-Khaled, G. Anabwani, H.R. Anderson, R. Beasley, B. Bjorksten, M.L. Burr, T.O. Clayton, P. Ellwood, U. Keil, C.K.W. Lai, J. Mallol, F.D. Martinez, E.A. Mitchell, S. Montefort, N. Pearce, C.F. Robertson, J.R. Shah, B. Sibbald, D.P. Strachan, E. von Mutius, S.K. Weiland, H.C. Williams, ISAAC Steering Committee, Worldwide variations in the prevalence of asthma symptoms: the international study of asthma and allergies in childhood (ISAAC), Eur. Respir. J. 12–2 (1998) 315–335.
- [6] E. Höllbacher, T. Ters, C. Rieder-Gradinger, E. Srebotnik, Emissions of indoor pollutants from six user scenarios in a model room, Atmos. Environ. 150 (2017) 389–394.
- [7] G.D. Nielsen, S.T. Larsen, P. Wolkoff, Re-evaluation of the WHO (2010) formaldehyde indoor air quality guideline for cancer risk assessment, Arch. Toxicol. 91 (2017) 35–61.
- [8] D.M. Main, T.J. Hogan, Health effects of low-level exposure to formaldehyde, Off. Publ. Ind. Med. Assoc. 25 (1983) 896–900.
- [9] World Health Organization, IARC Working Group on the Evaluation of Carcinogenic Risks to Humans: Formaldehyde, 2-butoxyethanol and 1-tert-butoxypropan-2-ol, 2006. Lyon.
- [10] World Health Organization Regional Office for Europe, Air Quality Guidelines for Europe, 2000. Copenhagen.
- [11] C.W.F. Yu, J.T. Kim, Long-term impact of formaldehyde and VOC emissions from wood-based products on indoor environments; and issues with recycled products, Indoor Built Environ. 21 (2012) 137–149.

- [12] N. Shinohara, M. Fujii, A. Yamasaki, Y. Yanagisawa, Passive flux sampler for measurement of formaldehyde emission rates, *Atmos. Environ.* 41 (2007) 4018–4028.
- [13] N. Shinohara, Y. Kai, A. Mizukoshi, M. Fujii, K. Kumagai, Y. Okuizumi, M. Jona, Y. Yanagisawa, On-site passive flux sampler measurement of emission rates of carbonyls and VOCs from multiple indoor sources, *Build. Environ.* 44 (2009) 859–863.
- [14] A. Blondel, H. Plaisance, Validation of a passive flux sampler for on-site measurement of formaldehyde emission rates from building and furnishing materials, *Anal. Meth.* 2 (2010) 2032–2038.
- [15] S. Yamashita, K. Kume, T. Horiike, N. Honma, M. Fusaya, T. Ohura, T. Amagai, A simple method for screening emission sources of carbonyl compounds in indoor air, *J. Hazard. Mat.* 178 (2010) 370–376.
- [16] J. Nicolle, V. Desauziers, P. Mocho, Solid phase microextraction sampling for a rapid and simple on-site evaluation of volatile organic compounds emitted from building materials, *J. Chromatogr. A* 1208 (2008) 10–15.
- [17] J. Nicolle, V. Desauziers, P. Mocho, O. Ramalho, Optimization of FLEC®-SPME for field passive sampling of VOCs emitted from solid building materials, *Talanta* 80 (2009) 730–737.
- [18] C. Garden, S. Semple, K. De Brouere, INTERA B4 Project, A Review of Existing Indoor Pollutant Exposure Data and Models, Integrated Exposure for Risk Assessment in Indoor Environments (INTERA), 2011.
- [19] National Research Council, Indoor Pollutants, National Academy Press, Washington, 1981.
- [20] W.W. Nazaroff, G.R. Cass, Mathematical modelling of chemically reactive pollutants in indoor air, *Environ. Sci. Technol.* 20 (1986) 924–934.
- [21] P.B. Ryan, J.D. Spengler, P.F. Halfpenny, Sequential box models for indoor air quality: application to airliner cabin air quality, *Atmos. Environ.* 22 (1987) 1031–1038.
- [22] A. Jurelionis, E. Isevičius, CFD predictions of indoor air movement induced by cold window surfaces, *J. Civ. Eng. Manag.* 14 (1) (2008) 29–38.
- [23] H.J. Steeman, A. Janssens, J. Carmeliet, M. De Paepe, Modelling indoor air and hydrothermal wall interaction in building simulation: comparison between CFD and a well-mixed zonal model, *Build. Environ.* 44 (3) (2009) 572–583.
- [24] L. Yang, Computational fluid dynamics technology and its application in wind environment analysis, *J. Urban. Technol.* 17 (3) (2010) 67–81.
- [25] B. Blocken, T. Stathopoulos, J. Carmeliet, Application of computational fluid dynamics in building performance simulation for the outdoor environment: an overview, *J. Build. Perform. Simul.* 4 (2) (2011) 157–184.
- [26] R. Ramponi, B. Blocken, CFD simulation of cross-ventilation for a generic isolated building: impact of computational parameters, *Build. Environ.* 53 (12) (2012) 34–48.
- [27] L. Yang, M. Ye, B.J. He, CFD simulation research on residential indoor air quality, *Sci. Total Environ.* 472 (2014) 1137–1144.
- [28] I.K. Panagopoulos, A.N. Karayannis, P. Kassomenos, K. Aravossis, A CFD simulation study of VOC and formaldehyde indoor air pollution dispersion in an apartment as part of an indoor pollution management plan, *Aerosol Air Qual. Res.* 11 (6) (2011) 758–762.
- [29] D. Bourdin, P. Mocho, V. Desauziers, H. Plaisance, Formaldehyde emission behavior of building materials: on-site measurements and modeling approach to predict indoor air pollution, *J. Hazard. Mat.* 280 (2014) 164–173.
- [30] T. Misić, M. Najdanović-Lukić, L. Nesić, Dimensional analysis in physics and the Buckingham theorem, *Eur. J. Phys.* 31 (4) (2010) 893–906.