



HAL
open science

Investigation of Thermoacoustic Oscillations in a Trapped Vortex Combustor

Pradip Xavier, Alexis Vandael, G. Godard, Bruno Renou, Gilles Cabot, Frederic Grisch, Mourad Boukhalfa, Michel Cazalens

► **To cite this version:**

Pradip Xavier, Alexis Vandael, G. Godard, Bruno Renou, Gilles Cabot, et al.. Investigation of Thermoacoustic Oscillations in a Trapped Vortex Combustor. 7th European Combustion Meeting, Mar 2015, Budapest, Hungary. hal-02129415

HAL Id: hal-02129415

<https://hal.science/hal-02129415v1>

Submitted on 5 Aug 2023

HAL is a multi-disciplinary open access archive for the deposit and dissemination of scientific research documents, whether they are published or not. The documents may come from teaching and research institutions in France or abroad, or from public or private research centers.

L'archive ouverte pluridisciplinaire **HAL**, est destinée au dépôt et à la diffusion de documents scientifiques de niveau recherche, publiés ou non, émanant des établissements d'enseignement et de recherche français ou étrangers, des laboratoires publics ou privés.

INVESTIGATION OF THERMO-ACOUSTIC OSCILLATIONS IN A TRAPPED VORTEX MODEL COMBUSTOR

P. Xavier¹, A. Vandel¹, G. Godard¹, B. Renou¹, G. Cabot¹, F. Grisch¹, M.A. Boukhalfa¹, M. Cazalens²

¹ CORIA UMR 6614 – Normandie University, CNRS – University of Rouen & INSA of Rouen, Saint Etienne du Rouvray, 76800, France

² SAFRAN Tech

Context and Objectives

- Reduction of **pollutant emissions** in aero-engines.
- Development of **lean combustion** technologies.
- Improvement of **flame stabilization**.

Development of **disruptive concepts** for the combustor architecture:

Trapped vortex combustor (TVC): flow passing above an active cavity

Few data on **anomalous operating conditions** (combustion instabilities)

Goals of this work:

- Investigate mechanisms of **thermo-acoustic oscillations**
- Consequences on the **flame stabilization** in a TVC

TVC concept

Developed by US Air Force and GE in the 90's.

Cavity based flame-holder

Ignition and stabilization of a **lean-fuel flow**

- Pilot region confinement
- High-speed mainstream flows
- Low-NOx technology
- Flexible (RQL, staged)

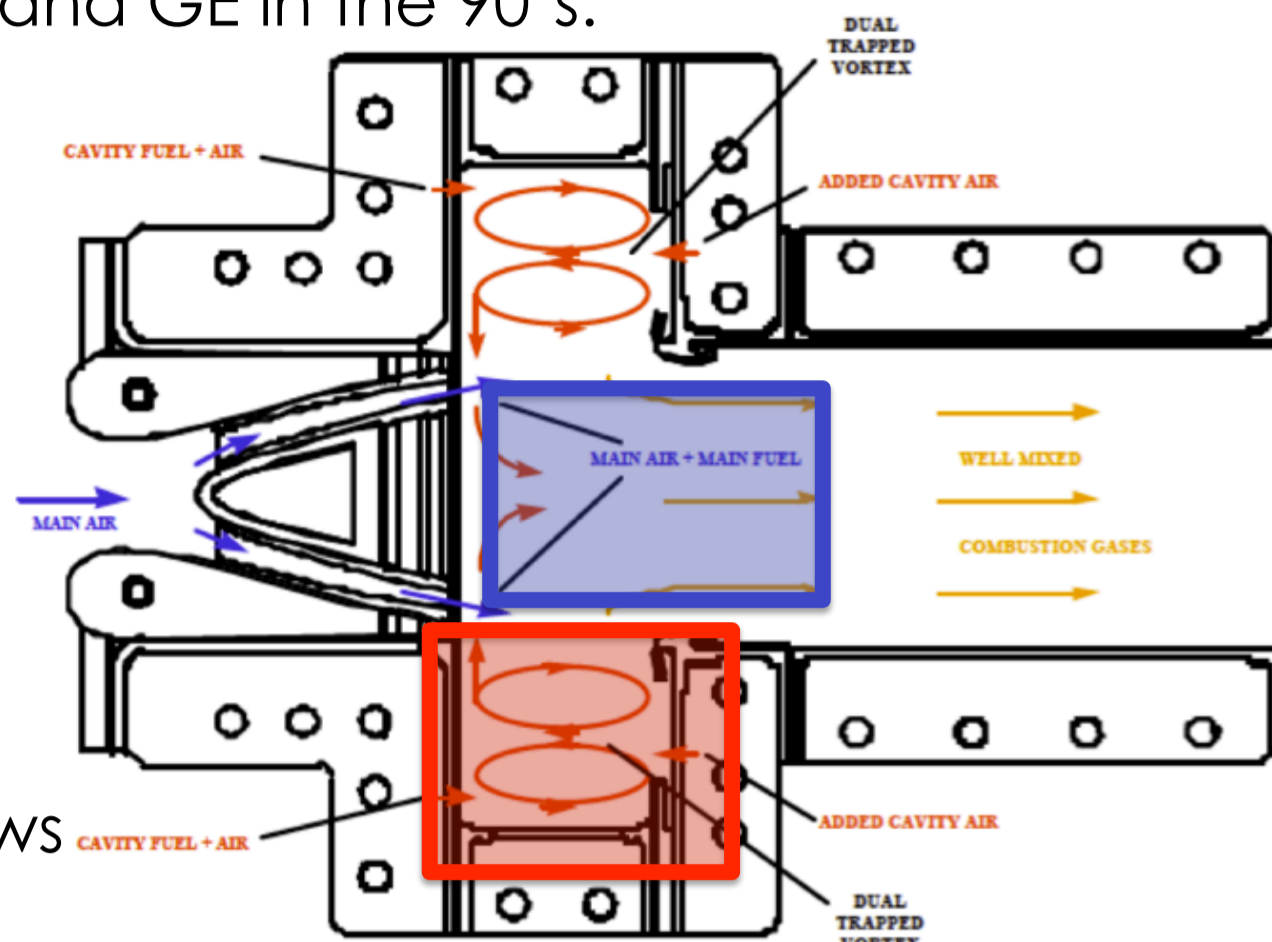

TVC burner and experimental setup

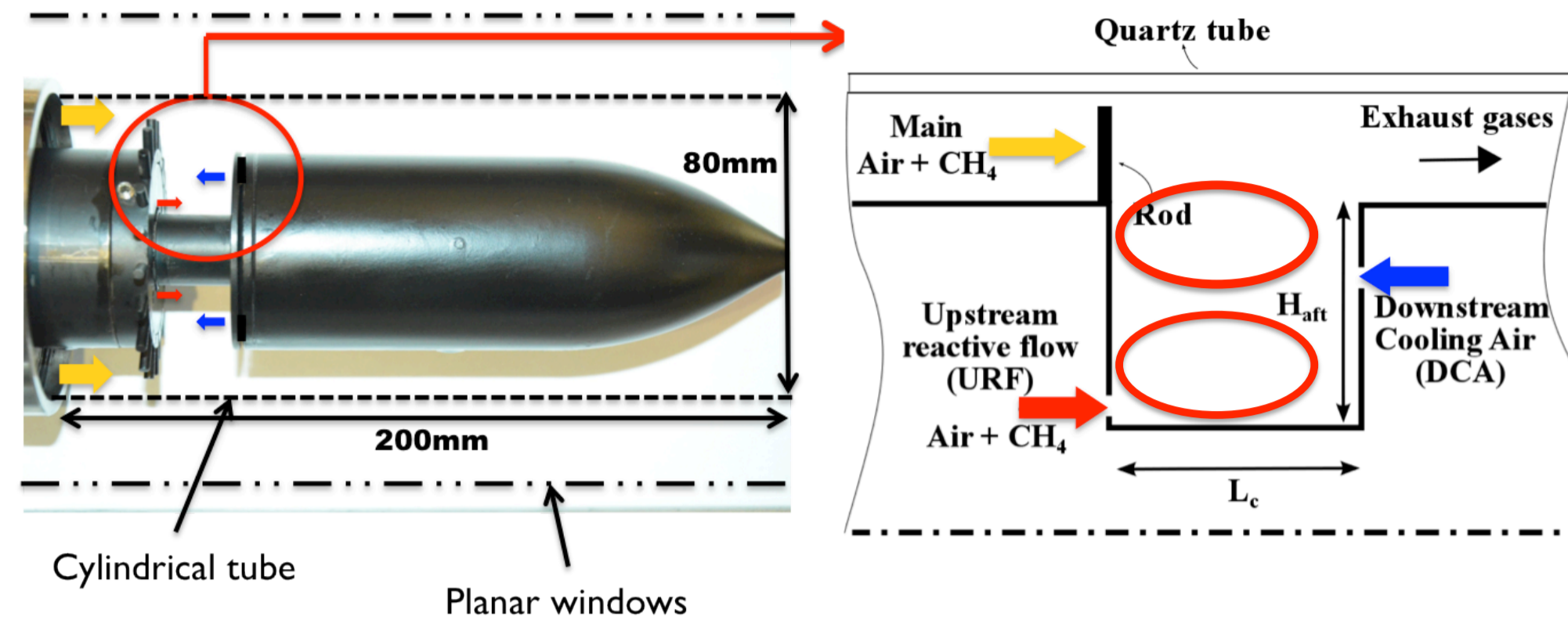

- Annular geometry with full optical access
- Fueled with CH_4
- Injection systems: slots
- Acoustic conditions: choked

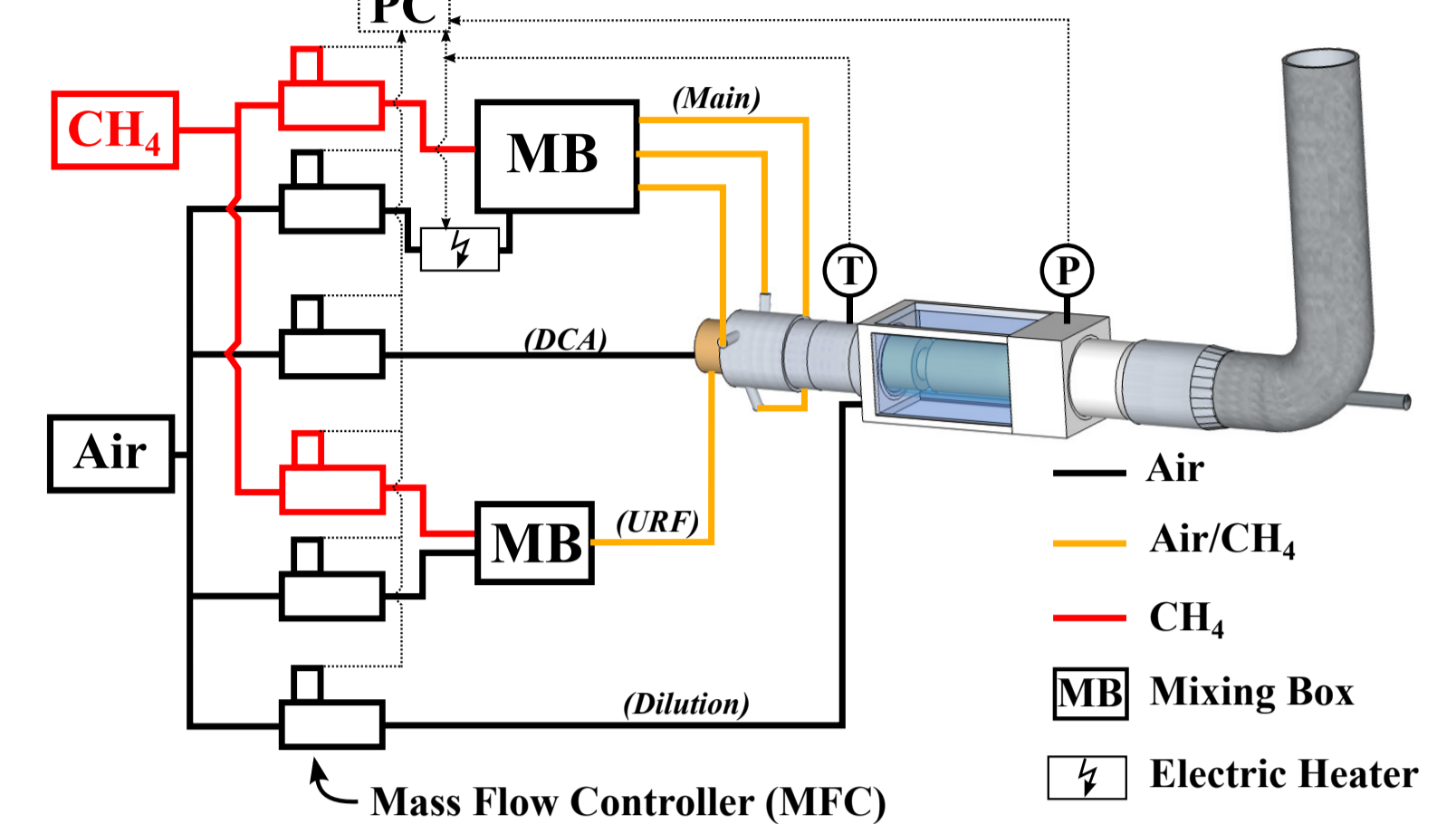

- 6 independent mass flow controllers
- Premixed feeding lines

Operating conditions [3]

Region	Air	Fuel	Φ
Main [g/s]	21.50	1.0	0.8
Bulk speed [m/s]	5.0		
URF [g/s]	0.7	0.12	3.0
Bulk speed [m/s]	6.0		
DCA [g/s]	1.0	0.0	-
Bulk speed [m/s]	3.6		

$\Phi_{\text{glob}} = 0.83$
 $P_{\text{glob}} = 60\text{kW}$
 $P_{\text{ch}} = 1.7\text{ bar}$

Stable case

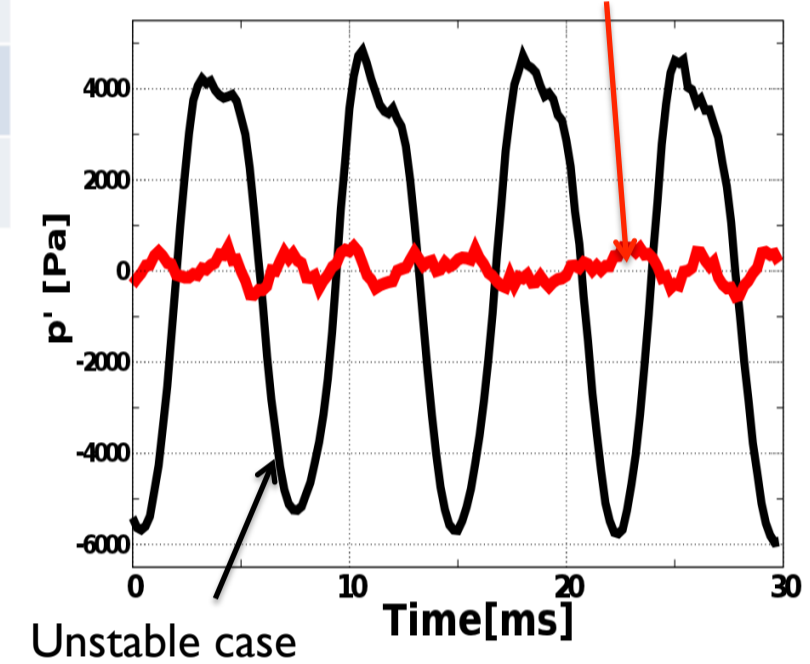

The combustor can exhibit large and self-sustained pressure oscillations for some operating conditions.

Optical diagnostics

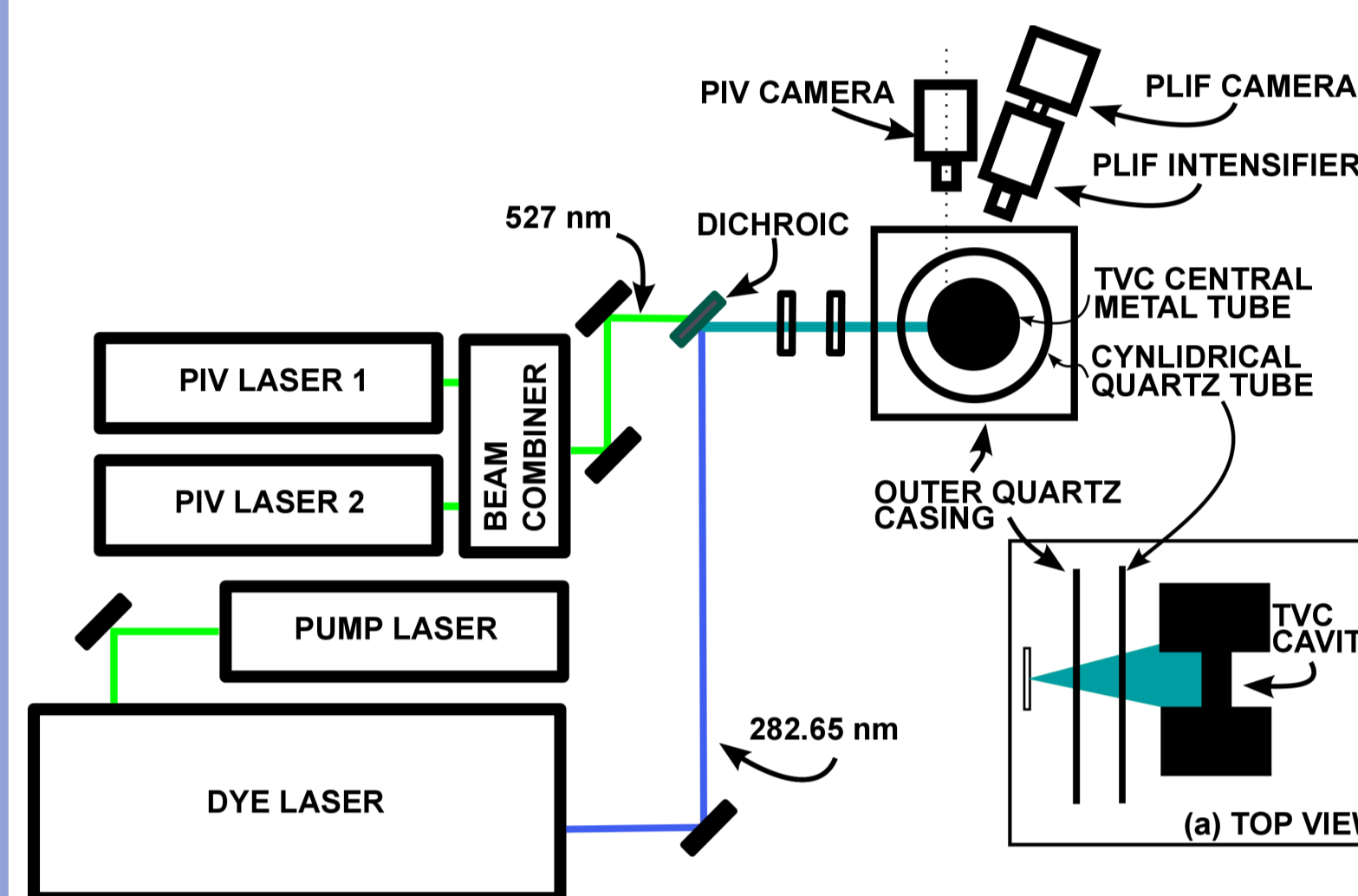

Coupled high-speed laser diagnostics

High-speed PIV @ 2.5KHz

- Pump laser: 2x30W Nd:YLF Darwin Dual @ 2.5kHz
- Collection system: Phantom V10, Nikon lens f/2.8 105mm
- Output energy: 12mJ / shot @ 2.5kHz
- Solid ZrO_2 seeding for each injection w/ fluidized beds

Dynamic pressure sensor Kistler 7061B

High-speed OH-PLIF @ 10kHz

- Pump laser: 100W 527nm Edge Wave @ 10kHz
- Tunable dye laser Sirah CREDO operating with Rhodamine 6G
- Collection system: Photron Fastcam SA1.1, IRO intensifier, UV Halle lens f/2.8 100mm
- Output energy: 420 μJ / shot @ 10kHz

Photo Multiplier Tube Hamamatsu 6780-20 + CH^* filter

Combustion instability cycle

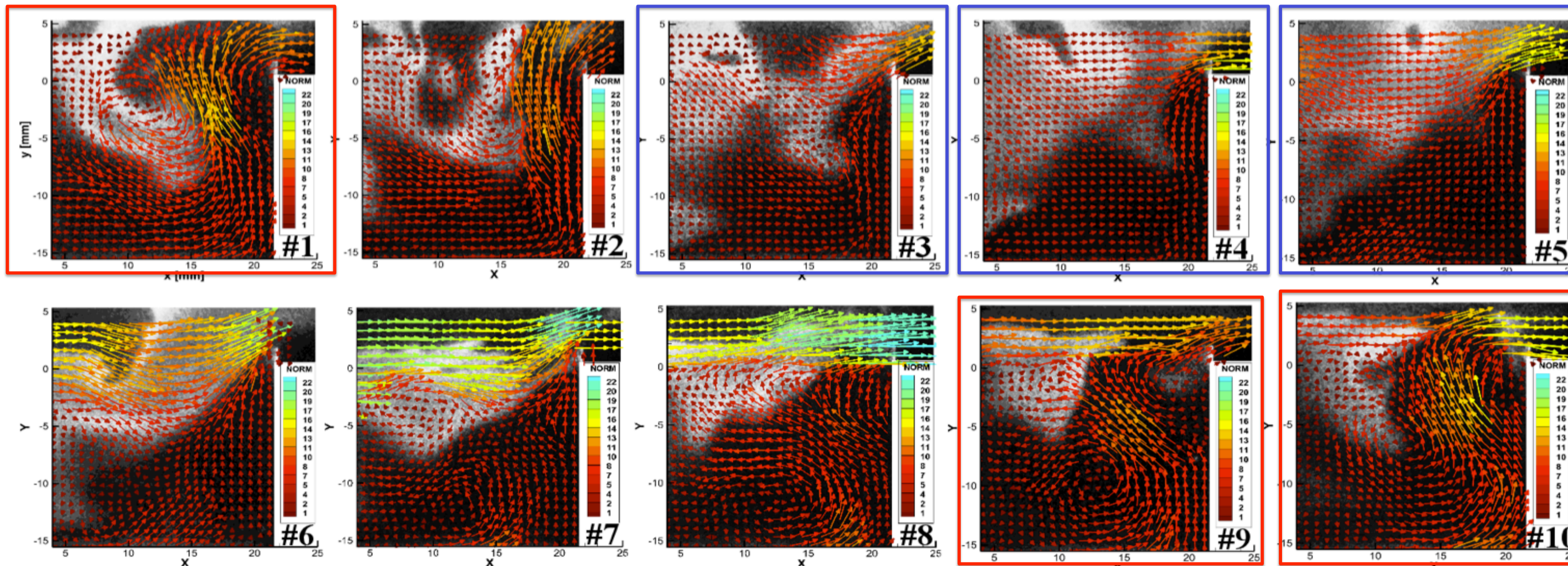
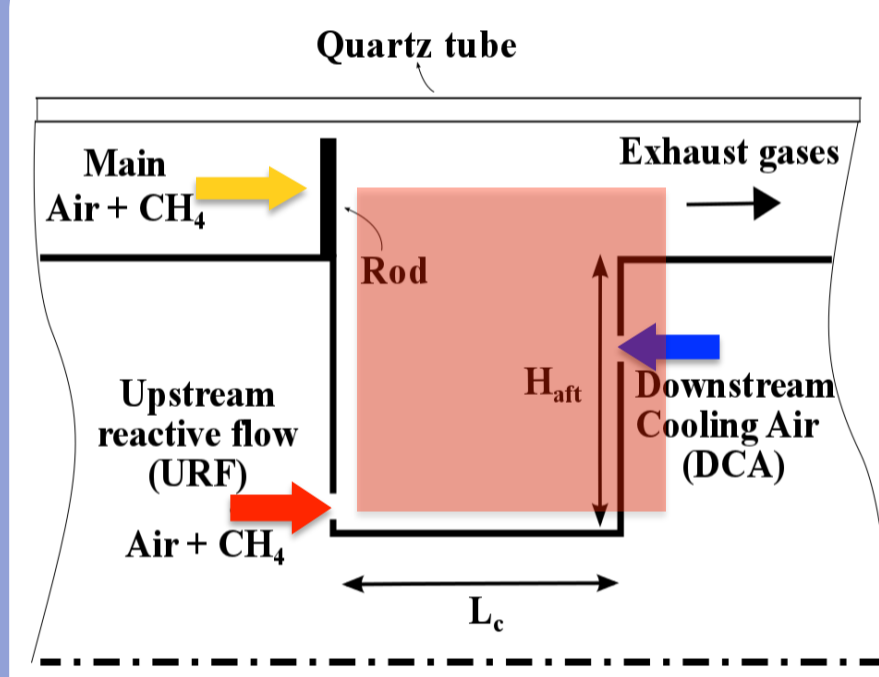

#1,9,10: strong flow ejection from the cavity to the mainstream
→ **important interaction between the cavity & the main channel**

#3,4,5: No flow topology in the combustor
→ **pressure effects on the injection systems**

#7,8: vortices in the cavity, burned gases in the shear layer
→ « ideal flow topology »

Pressure spectrum shows several spikes: 122 Hz, 244Hz, ...
→ **Periodic motion with nonlinearities**

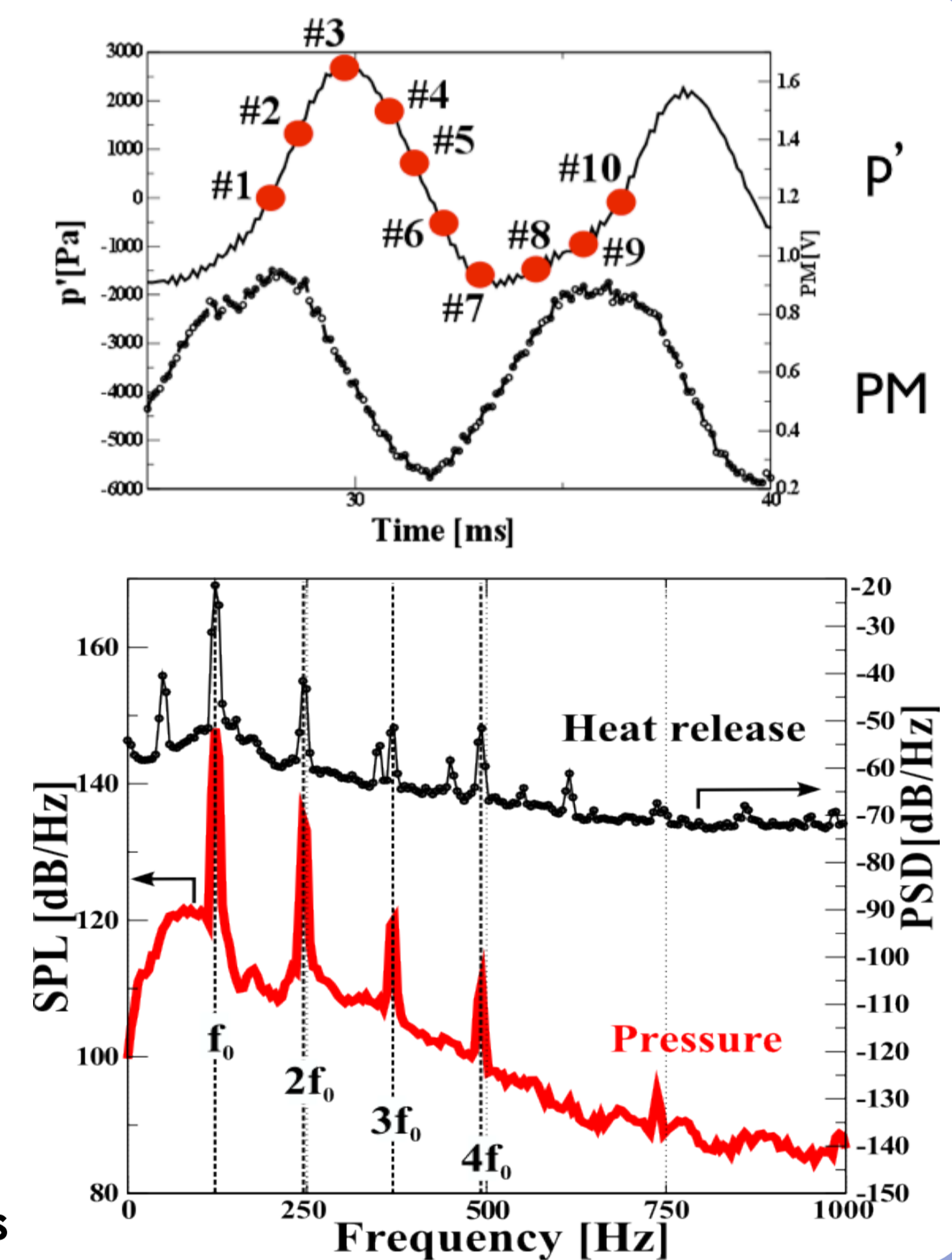

Burner acoustics

Impulse response test

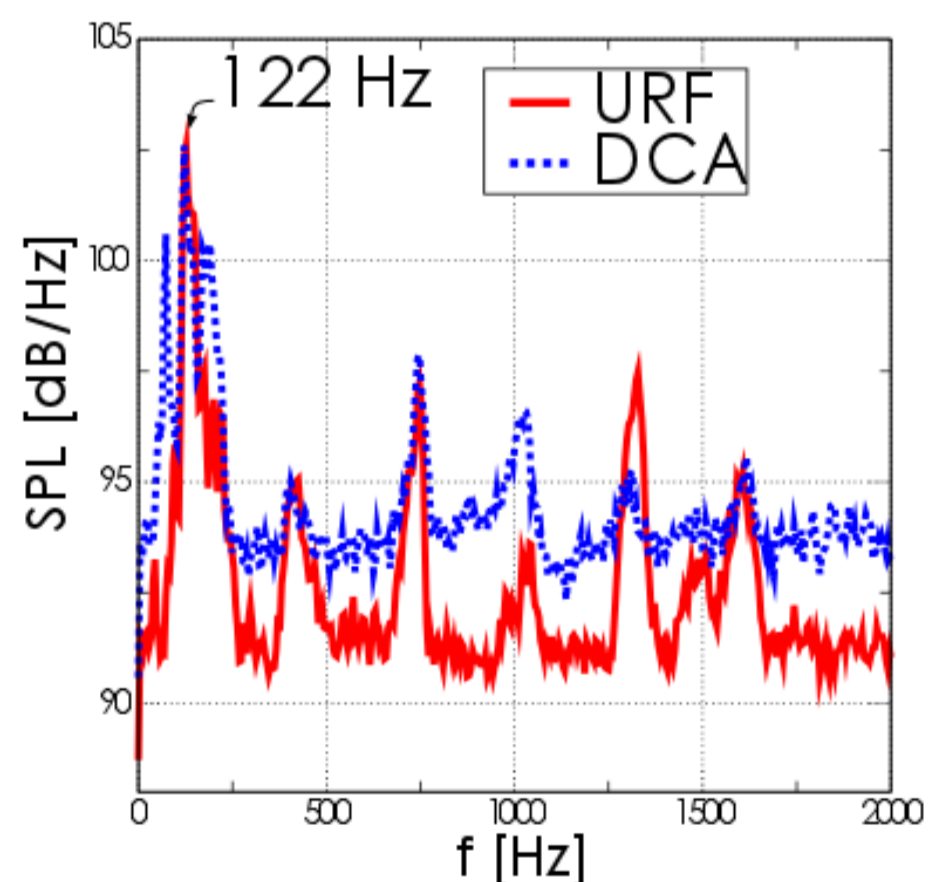

Cavity feeding lines subject to an important acoustic activity
→ **Pressure blockage leads to a flow-rate oscillations**

Analytical model

- 1D model (planar waves)
- choked-plenum conditions

Set of resonant frequencies:

$$f_n = (2n + 1)\bar{c}/4L$$

The experimental frequency is retrieved for:

$$f_5 = 119\text{Hz}$$

Flow Dynamics

Effects of pressure fluctuations on the flow unsteadiness (i.e., coherent structures).

Proper orthogonal decomposition (POD)[4]:

$$\mathbf{u} = [u(t), v(t)] \approx \sum_{k=1}^K a_k(t)\Phi_k(\mathbf{x})$$

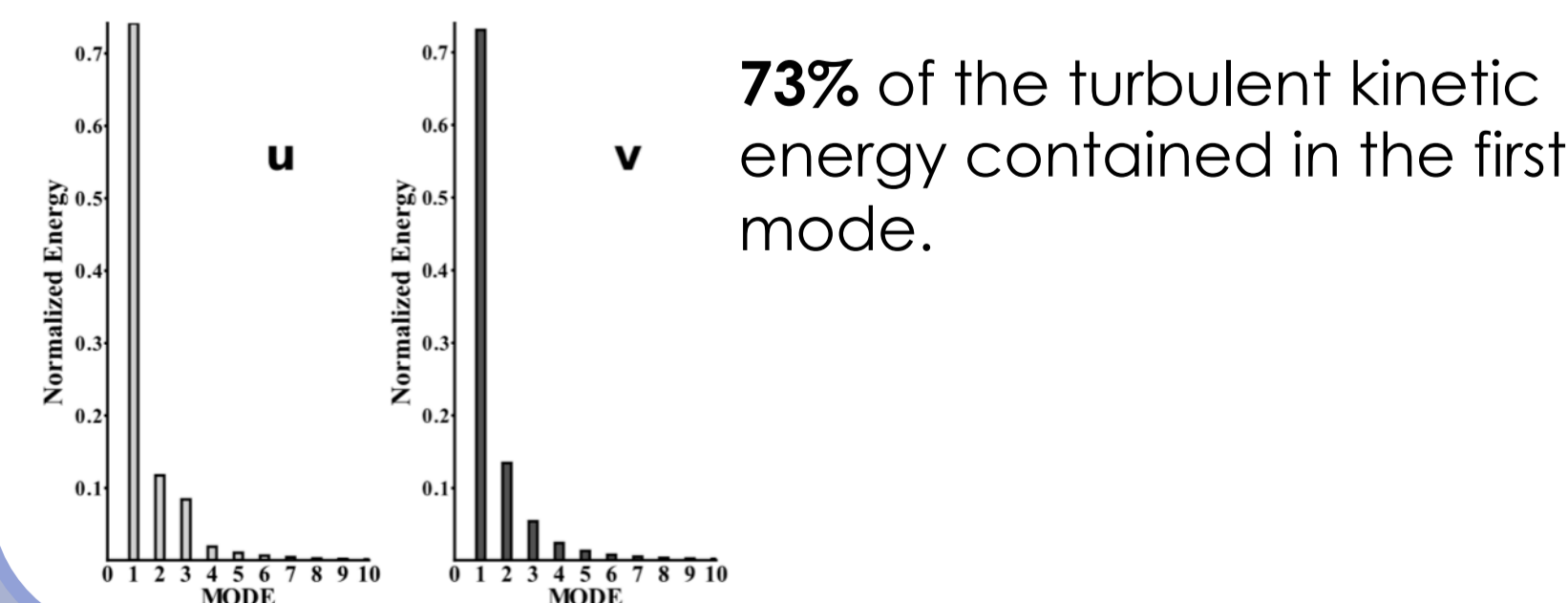

73% of the turbulent kinetic energy contained in the first mode.

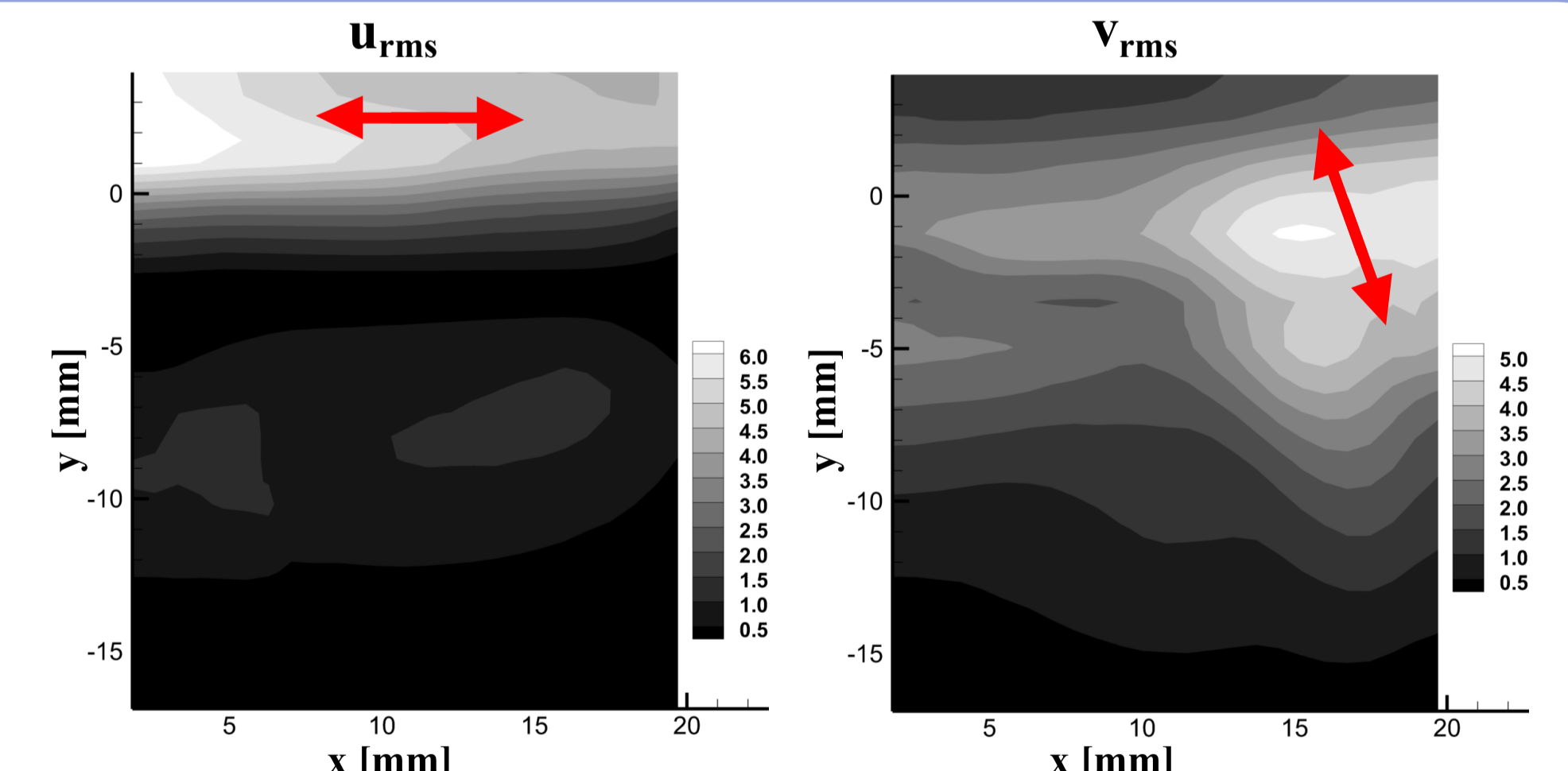

- large fluctuations in the mainstream and next to the cavity trailing edge.
- Strong interactions leads to important flow oscillations

Combustion Dynamics

Effects of pressure and flow fluctuations on the combustion process

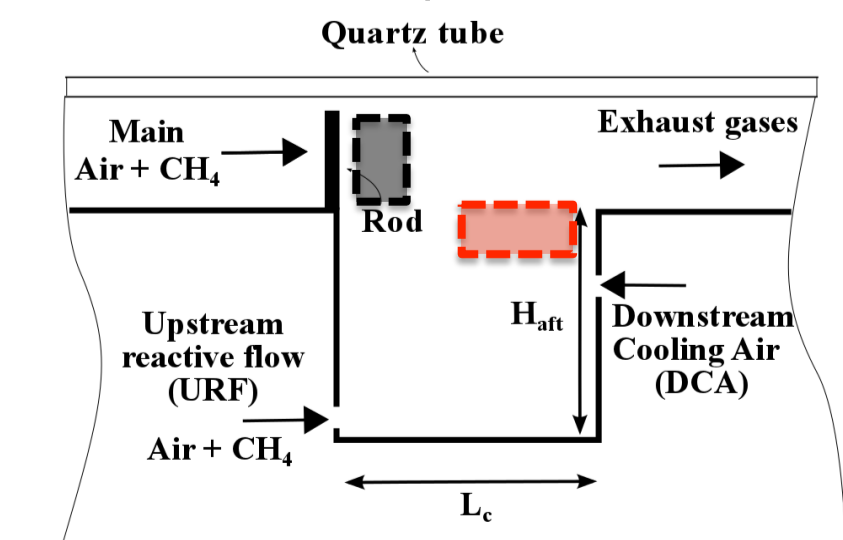

Statistical joint analysis (pdfs) with 1) flow (velocities) and 2) combustion (variable progress \mathbf{c})

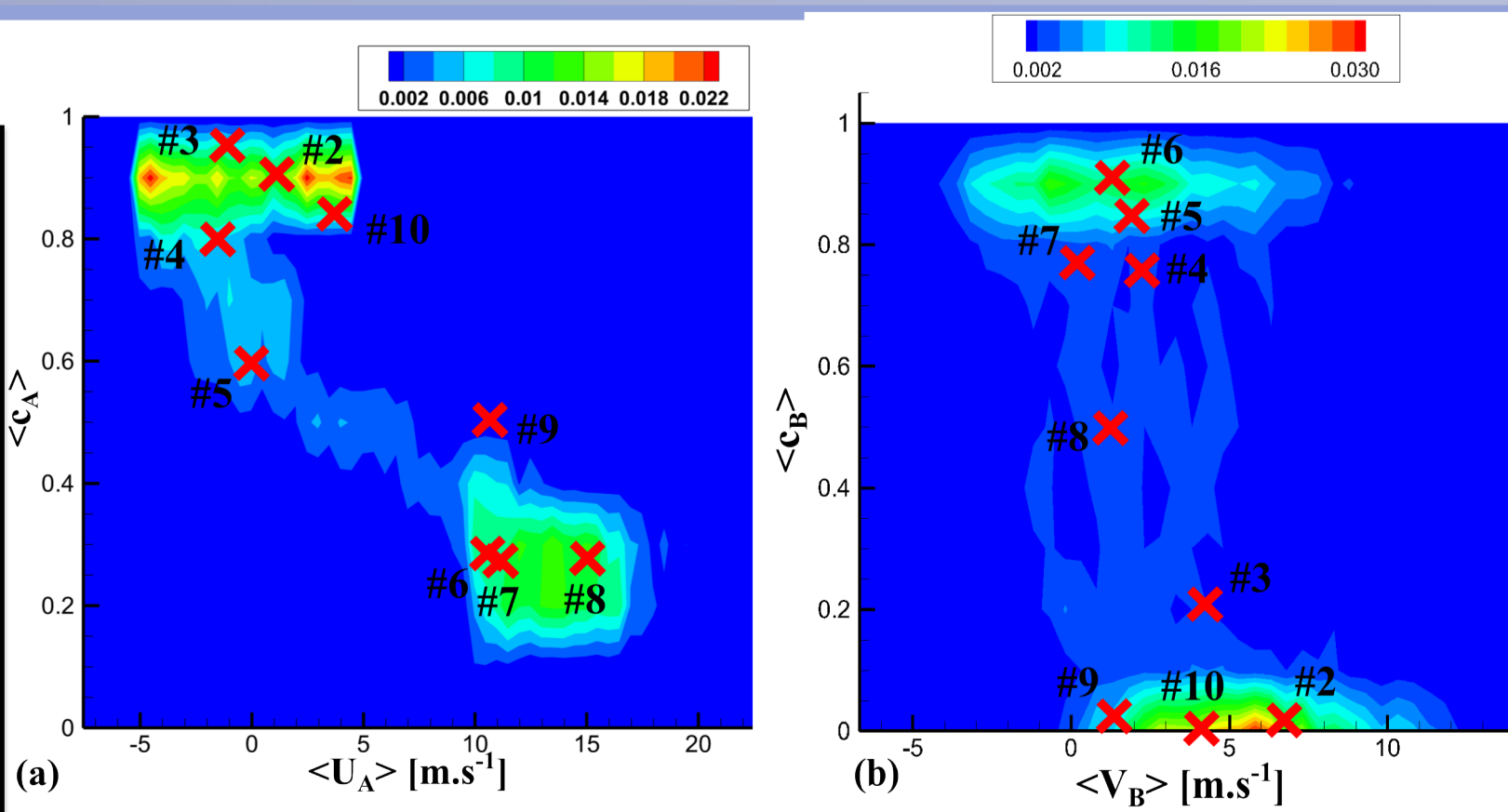

Pulsed combustion regime

→ **No possibilities to obtain efficient mass transfers and stabilize a flame**

Bimodal distribution

opposite combustion and aerodynamics

Alternation between these two spikes

Conclusions

Scenario of combustion instabilities in a TVC.

Injection strategy + cavity confinement need to be optimized in order to obtain a stable combustion

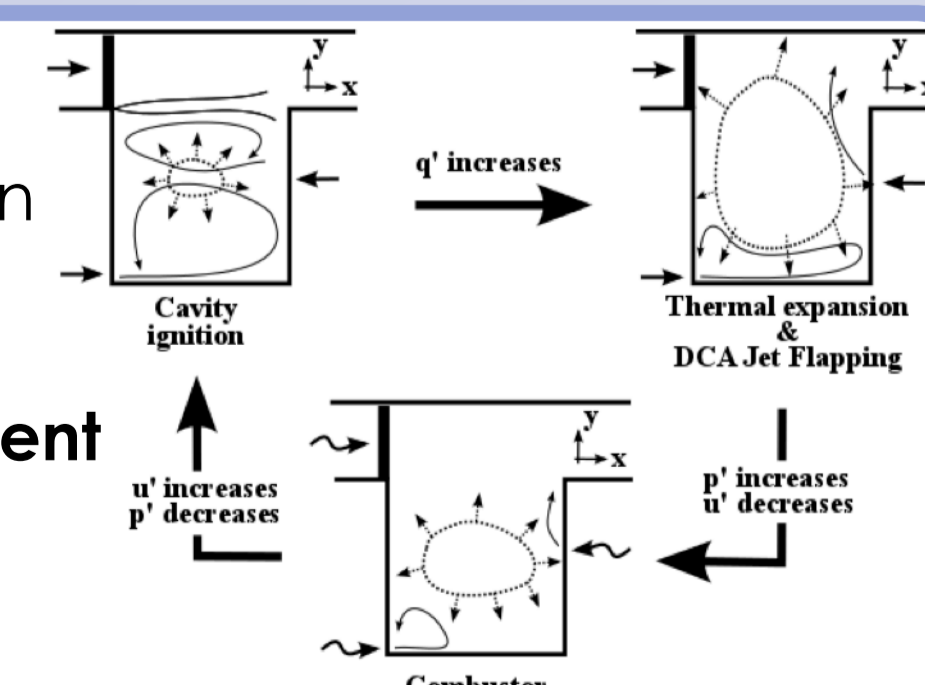

References

- [1] Hsu et al., JPP (14), 1998
- [2] Roquemore et al., AIAA (0483), 2001
- [3] Burguburu et al., Proc. ASME (68451), 2012
- [4] Lumley et al., Atmospheric turbulence and radio wave propagation, 1967