



HAL
open science

Identification of GBF1 as a cellular factor required for Hepatitis E virus

Rayan Farhat, Maliki Ankavay, Nadjet Lebsir, Jérôme Gouttenoire, Catherine L Jackson, Czeslaw Wychowski, Darius Moradpour, Jean Dubuisson, Yves Rouillé, Laurence Cocquerel

► **To cite this version:**

Rayan Farhat, Maliki Ankavay, Nadjet Lebsir, Jérôme Gouttenoire, Catherine L Jackson, et al.. Identification of GBF1 as a cellular factor required for Hepatitis E virus. *Cellular Microbiology*, 2018, 20 (1), pp.e12804. 10.1111/cmi.12804 . hal-02117708

HAL Id: hal-02117708

<https://hal.science/hal-02117708v1>

Submitted on 2 May 2019

HAL is a multi-disciplinary open access archive for the deposit and dissemination of scientific research documents, whether they are published or not. The documents may come from teaching and research institutions in France or abroad, or from public or private research centers.

L'archive ouverte pluridisciplinaire **HAL**, est destinée au dépôt et à la diffusion de documents scientifiques de niveau recherche, publiés ou non, émanant des établissements d'enseignement et de recherche français ou étrangers, des laboratoires publics ou privés.

1
2
3
4
5
6
7
8
9
10
11
12
13
14
15
16
17
18
19
20
21
22
23

Title:

**Identification of GBF1 as a cellular factor required for Hepatitis E virus
RNA replication**

Short title:

GBF1 is required for HEV replication

Authors:

Rayan FARHAT^a, Maliki ANKAVAY^a, Nadjat LEBSIR^a, Jérôme GOUTTENOIRE^b,
Catherine L. JACKSON^c, Czeslaw WYCHOWSKI^a, Darius MORADPOUR^b, Jean
DUBUISSON^a, Yves ROUILLE^a, Laurence COCQUEREL^a

^a University of Lille, CNRS, INSERM, CHU Lille, Pasteur Institute of Lille, U1019-UMR
8204-CIIL- Center for Infection and Immunity of Lille, F-59000 Lille, France.

^b Division of Gastroenterology and Hepatology, Centre Hospitalier Universitaire Vaudois,
University of Lausanne, Lausanne, Switzerland.

^c Institut Jacques Monod, CNRS UMR 7592, Université Paris Diderot, Sorbonne Paris Cité,
Paris, France.

1 **Correspondence:**

2 Dr Laurence Cocquerel, Molecular & Cellular Virology, CIIL, CNRS-UMR8204 & Inserm-
3 U1019, Institut Pasteur de Lille, Bâtiment IBL, 1 rue du Pr. Calmette, CS50447, 59019 Lille
4 cedex, France.

5 E-mail: laurence.cocquerel@ibl.cnrs.fr

6

7 **Grant Support:**

8 This work was supported by the French “Agence Nationale de la Recherche sur le Sida et les
9 hépatites virales” (ANRS). R.F. and M.A. were supported by a fellowship from the ANRS.
10 JG and DM acknowledge support by the Gilead Sciences International Research Scholars
11 Program in Liver Disease (Award 2015 to JG) and the Swiss National Science Foundation
12 (grant 31003A-156030 to DM).

13

14 **Abbreviations:**

15 aa, amino acid; BFA, brefeldin A; DMEM, Dulbecco’s modified Eagle’s medium; ER,
16 endoplasmic reticulum; ERGIC, ER-Golgi intermediate compartment; FCS, fetal calf serum;
17 FLuc, *Firefly* luciferase; GBF1, guanine nucleotide-exchange factor Golgi Brefeldin A
18 resistance Factor 1; GCA, Golgicide A; GEF, guanine nucleotide exchange factor, GLuc,
19 *Gaussia* luciferase; gt, genotype; HCV, hepatitis C virus; HEV, hepatitis E virus; MAb,
20 monoclonal antibody; ORFs, open reading frames; PBS, phosphate buffered saline; p.e., post-
21 electroporation; WB, western-blotting.

22

23 **Disclosures:**

24 All authors disclose no conflicts.

1 **ABSTRACT**

2

3 The hepatitis E virus (HEV) genome is a single-stranded, positive-sense RNA that encodes
4 three proteins including the ORF1 replicase. Mechanisms of HEV replication in host cells are
5 unclear and only a few cellular factors involved in this step have been identified so far. Here,
6 we used brefeldin A (BFA) that blocks the activity of the cellular Arf guanine nucleotide
7 exchange factors GBF1, BIG1 and BIG2, which play a major role in reshuffling of cellular
8 membranes. We showed that BFA inhibits HEV replication in a dose-dependent manner. The
9 use of siRNA and Golgicide A identified GBF1 as a host factor critically involved in HEV
10 replication. Experiments using cells expressing a mutation in the catalytic domain of GBF1
11 and overexpression of wildtype GBF1 or a BFA-resistant GBF1 mutant rescuing HEV
12 replication in BFA-treated cells, confirmed that GBF1 is the only BFA-sensitive factor
13 required for HEV replication. We demonstrated that GBF1 is likely required for the activity
14 of HEV replication complexes. However, GBF1 does not colocalize with the ORF1 protein
15 and its subcellular distribution is unmodified upon infection or overexpression of viral
16 proteins, indicating that GBF1 is likely not recruited to replication sites. Together, our results
17 suggest that HEV replication involves GBF1-regulated mechanisms.

18

1 INTRODUCTION

2

3 Hepatitis E virus (HEV) is increasingly recognised as the major cause of acute hepatitis
4 worldwide. This virus is annually responsible for 20 million infections with 3.4 million
5 symptomatic cases and 70,000 deaths mainly occurring in less developed regions of the world
6 (Debing *et al.*, 2016). Though infection by HEV is usually self-resolving, severe forms or
7 chronic infections have been described, mainly in immunocompromised patients. A high rate
8 of mortality has also been reported among pregnant women. In addition, HEV infection has
9 been associated with a broad range of extrahepatic manifestations, including renal injury and
10 a variety of neurological disorders (Kamar *et al.*, 2016). Four genotypes (gt) are pathogenic in
11 humans. Gt1 and gt2 exclusively infect humans, whereas gt3 and gt4 are zoonotic and mainly
12 infect mammals with occasional transmission to humans (Doceul *et al.*, 2016). In
13 industrialized countries, the most common genotype causing HEV infection is gt3.
14 Importantly, due to the evolution toward chronicity in immunocompromised infected patients,
15 HEV transmission through blood transfusion, resistance of some infected patients to ribavirin
16 and complications in patients with preexisting liver disease, HEV infection is now considered
17 as an emerging problem in industrialized countries (Sayed *et al.*, 2015).

18 HEV has been classified as the sole member of the *Orthohepevirus* genus within the
19 *Hepeviridae* family (Smith *et al.*, 2014). It is a quasi-enveloped virus containing a linear,
20 single-stranded, positive-sense RNA genome that encodes three open reading frames (ORFs),
21 namely, ORF1, ORF2 and ORF3 (Tam *et al.*, 1991). ORF1 is the largest gene that encodes a
22 non-structural polyprotein (ORF1 protein) that contains several functional domains essential
23 for viral replication (Koonin *et al.*, 1992). These functional domains include the
24 methyltransferase (Met), papain-like cysteine protease (PCP), RNA helicase (Hel) and RNA-
25 dependent RNA polymerase (RdRp) (reviewed in (Debing *et al.*, 2016)). To date, there is no

1 clear evidence of ORF1 protein processing by protease and antibodies that robustly recognize
2 ORF1 protein are not available. ORF2 encodes the ORF2 viral capsid protein, which is
3 involved in particle assembly, binding to host cells and eliciting neutralizing antibodies. Very
4 recently, we demonstrated that during its lifecycle HEV produces three forms of the ORF2
5 capsid protein: ORF2i (infectious/intracellular ORF2), ORF2g (glycosylated ORF2) and
6 ORF2c (cleaved ORF2). The ORF2i protein is associated with infectious particles, whereas
7 ORF2g and ORF2c proteins are massively produced glycoproteins that are not associated
8 with infectious particles and are the major antigens present in HEV-infected patient sera
9 (Montpellier *et al.*, 2017). ORF3 encodes a small multifunctional phosphoprotein that
10 is involved in virion morphogenesis and egress (reviewed in (Holla *et al.*, 2013)).

11 Due to difficulties in efficiently propagating HEV in cell culture, numerous pathways and
12 processes of the HEV lifecycle remain to be elucidated. Notably, mechanisms leading to HEV
13 replication are particularly poorly understood. However, it has been shown that the ORF1
14 protein might be membrane-associated and localized in the endoplasmic reticulum-Golgi
15 intermediate compartment (ERGIC), suggesting that HEV replication might occur within the
16 early secretory pathway (Perttilä *et al.*, 2013). Plus-strand RNA virus replication occurs in
17 close association with host cell membranes. In infected cells, cellular and viral factors
18 cooperatively generate particular structures resembling organelles that are named viral
19 replication factories. This compartmentalisation allows for coordination of the different steps
20 of the replication cycle, highly efficient RNA replication and protects the viral genome from
21 cell defense mechanisms. It has to be noted that for a number of viruses, the viral budding site
22 is located near the replication factories, indicating a spatial coordination of replication and
23 viral assembly steps. To induce these massive membrane rearrangements, viruses use cellular
24 factors active on membranes and exploit the cellular pathways involved in membrane
25 homeostasis (reviewed in (Paul, 2013)). In particular, some viruses divert components from

1 the cellular secretory pathway. Indeed, it has been shown in our laboratory that the guanine
2 nucleotide-exchange factor Golgi Brefeldin A resistance Factor 1 (GBF1) is necessary for
3 hepatitis C virus (HCV) replication (Goueslain *et al.*, 2010; Farhat *et al.*, 2016). GBF1 has
4 also been identified as a cellular factor essential for the replication of a number of other
5 viruses such as Picornaviruses and Coronaviruses (Verheije *et al.*, 2008; Belov *et al.*, 2008;
6 Lanke *et al.*, 2009; van der Linden *et al.*, 2010).

7 To investigate HEV replication mechanisms, we used Brefeldin A (BFA), a fungal metabolite
8 inhibiting the activation of Arf proteins, small G-proteins regulating the cellular secretory
9 pathway. The inactive, cytoplasmic GDP-bound form of Arf proteins, upon nucleotide
10 exchange to GTP, undergoes conformational changes that allow Arf-GTP proteins to bind
11 membranes. The active GTP-bound form of Arf proteins is essential for the formation of
12 secretory vesicles, actin remodeling and phospholipid metabolism by recruiting to membranes
13 effectors that mediate these processes. BFA blocks Arf activation by inhibiting a subset of
14 guanine nucleotide exchange factors (GEFs) that regulate the conversion of Arf-GDP into
15 Arf-GTP. In human cells, BFA inhibits the function of three of the 15 known Arf GEFs:
16 GBF1, BIG1 and BIG2, by stabilizing normally transient complexes formed between the GEF
17 and Arf-GDP. Here, we demonstrate that BFA inhibits HEV replication and identified GBF1
18 as the BFA-sensitive GEF required for HEV replication.

1 RESULTS

2

3 BFA inhibits HEV replication

4 In order to investigate the role of the cellular membranes during HEV infection, we used BFA
5 that blocks several membrane trafficking pathways and causes major membrane
6 rearrangements in the host cell (Klausner *et al.*, 1992). The *Gaussia luciferase* (Gluc)-
7 encoding subgenomic replicon construct derived from the HEV gt3 Kernow-C1 p6 strain was
8 modified to produce the subgenomic replicon p6^{SP}GLuc. In this replicon, the first twenty
9 amino acids matching with the signal peptide of *Gaussia luciferase* were deleted to block
10 secretion of the luciferase. In this context, the amount of intracellular GLuc is proportional to
11 viral RNA synthesis and consequently to HEV replication. In addition, this system allows
12 replication to be monitored independently of protein secretion which is blocked by BFA.
13 Huh-7.5 cells were electroporated with *in vitro*-transcribed p6^{SP}GLuc RNA and luciferase
14 activities were measured at 6, 24, 48 and 72 hours (h) post-electroporation (p.e.). For each
15 time point, values are presented as fold increase compared to luciferase activities measured at
16 6h p.e.. As shown in **Figure 1A**, the level of p6^{SP}GLuc steadily increased over time to reach a
17 fold increase of 490 times at 72h p.e., indicating that the p6^{SP}GLuc replicon efficiently
18 replicates in Huh-7.5 cells and can be used as a tool to study the HEV replication step. HEV-
19 p6^{SP}GLuc-electroporated Huh-7.5 cells were then treated for 16h with different
20 concentrations of BFA (**Figure 1B**). In parallel, transfected cells were treated with sofosbuvir,
21 an inhibitor of HCV polymerase, which has been recently described as a HEV replication
22 inhibitor (Dao Thi *et al.*, 2016) (**Figure 1C**). Luciferase activities were measured at 24, 48
23 and 72h p.e.. For each BFA concentration, values are presented as a percentage of replication
24 compared to non-treated cells (DMSO). As expected, treatment of p6^{SP}GLuc-electroporated
25 Huh-7.5 cells with sofosbuvir led to a dose-dependent decrease of HEV replication with a

1 50% inhibitory concentration (IC₅₀) of 10.6 μ M. Interestingly, treatment of electroporated
2 Huh-7.5 cells with BFA also led to a dose-dependent decrease of HEV replication with an
3 IC₅₀ of 0.02 μ g/ml (**Figure 1B**), indicating that BFA is an inhibitor of gt3 HEV replication.
4 Next, to verify that the decrease of HEV replication was not due to a toxic effect of the BFA
5 treatment, we performed a MTS viability assay on Huh7.5 cells treated for 16h with BFA. As
6 shown in **Figure 1D**, although a weak toxicity was observed at 1 μ g/ml, the concentration of
7 0.1 μ g/ml for which HEV replication was reduced by 1 log, had no significant toxic effect,
8 indicating that the inhibitory effect of BFA on HEV replication was not due to cell toxicity. In
9 order to confirm the inhibitory effect of BFA on HEV replication in another cell line, we next
10 analysed BFA activity on HEV replication in PLC3 cells, a PLC-PRF-5 derived cell clone
11 that highly replicates HEV genome (Montpellier *et al.*, 2017) (**Figure 1A**, PLC3/p6^{SP}GLuc).
12 As shown in **Figure 1E**, BFA efficiently inhibited p6^{SP}GLuc replication in transfected PLC3
13 cells, indicating that the inhibitory effect of BFA on HEV replication is not cell line-
14 dependent. We also analysed the antiviral activity of BFA in Huh-7.5 cells transfected with
15 the gt1 *Sar55 Firefly luciferase* (FLuc)-encoding subgenomic replicon (Sar55FLuc) (**Figure**
16 **1A and 1F**). As for gt3, BFA at 0.1 and 1 μ g/ml strongly inhibited gt1 replication, indicating
17 that the BFA inhibitory effect on HEV replication is not genotype dependent. Lastly, we
18 performed experiments with the full-length infectious p6 clone (Shukla *et al.*, 2012). Huh7.5
19 cells were electroporated with the full-length p6 strain RNA and then BFA was added for
20 16h. At 96h post-transfection, cells were fixed and analysed by immunofluorescence with an
21 anti-ORF2 capsid protein antibody. As shown in **Figure 1G**, treatment with BFA at 0.1 and 1
22 μ g/ml led to significant decrease of ORF2-positive cells, indicating that BFA inhibits the
23 HEV lifecycle.

24 Altogether, our results demonstrate that BFA inhibits HEV replication, likely by blocking a
25 cellular factor necessary for this step in the viral lifecycle.

1 **GBF1 is likely required for HEV replication**

2 BFA inhibits several cellular membrane trafficking pathways, primarily through inhibition of
3 its major cellular targets, members of the Arf GEF family. Among the 15 members of the Arf
4 GEF family in human cells, only 3 are inhibited by BFA: BIG1, BIG2 and GBF1 (D'Souza-
5 Schorey and Chavrier, 2006; Gillingham and Munro, 2007). To check which of the 3 BFA-
6 sensitive GEFs are required for HEV replication, we analyzed the effect of their depletion on
7 HEV replication (**Figure 2**). However, GBF1 silencing was toxic in our experimental
8 conditions due to the slow kinetics of HEV replication, which requires long depletion times.
9 As an alternative, we used Golgicide A (GCA) that specifically inhibits GBF1 with no effect
10 on BIG1 and BIG2 (Sáenz *et al.*, 2009). Huh7.5 cells were transfected with siRNA pools
11 targeting BIG1, BIG2, BIG1 and BIG2 or a non-targeting (NT) siRNA pool (**Figure 2A**).
12 Two days post-transfection, depleted cells were electroporated with the p6^{SP}GLuc replicon
13 and luciferase activities were measured at 24, 48 and 72h p.e., as described previously. As
14 shown in **Figure 2B**, depletion of BIG1, BIG2 or BIG1 and BIG2 together did not result in
15 any significant decrease of HEV replication levels. In contrast, when p6^{SP}GLuc-
16 electroporated Huh-7.5 cells were treated with GCA, which specifically targets GBF1, HEV
17 replication levels were strongly inhibited (**Figure 2C**) without any significant toxicity
18 (**Figure 2D**). Altogether, our results suggest that GBF1 is likely the BFA- and GCA-sensitive
19 factor required for HEV replication.

20

21 **HEV replication is resistant to BFA in cells expressing a point mutation in GBF1**

22 In a previous study assessing the role of GBF1 in HCV replication, we have isolated BFA-
23 resistant cell clones derived from the Huh-7 hepatoma cell line (Farhat *et al.*, 2013). The R2
24 cell line is resistant to 0.1 µg/ml of BFA and able to support HCV replication in the presence
25 of 100 times more of BFA than the parental Huh-7 cell line. This resistance is due to a point

1 mutation (M832L) in the *sec7* catalytic domain of GBF1 which is known to impair the
2 binding of BFA (Farhat *et al.*, 2013). In order to confirm that BFA inhibition of HEV
3 replication was only related to the effect of the drug on GBF1, we transfected the p6^{SP}GLuc
4 replicon in R2 and parental Huh-7 cells (**Figure 3**). BFA was added for 16h as in the previous
5 experiments. HEV replication was strongly inhibited by BFA in parental Huh-7 cells (**Figure**
6 **3A**). In contrast, the replication of p6^{SP}Gluc was almost insensitive to BFA in R2 cells
7 regardless of the concentration of BFA (**Figure 3B**).

8 Together, these results support the conclusion that GBF1 is the BFA-sensitive factor that is
9 required for HEV replication, and that the inhibition of HEV replication is not due to a direct
10 effect on the virus.

11

12 **Expression of wild-type GBF1 or BFA-resistant GBF1 mutant rescues HEV replication** 13 **in BFA-treated cells.**

14 To further confirm that GBF1 is the only host factor sensitive to BFA that is required for
15 HEV replication, we next used a GBF1 complementation assay (**Figure 4**). Indeed, it has
16 been shown that GBF1 overexpression or expression of the M832L BFA-resistant GBF1
17 mutant can rescue HCV replication from BFA inhibition whereas expression of the E794K
18 catalytically inactive GBF1 mutant cannot (Jackson and Casanova, 2000; Niu *et al.*, 2005;
19 Goueslain *et al.*, 2010; Farhat *et al.*, 2016). We therefore transfected Huh-7.5 cells with
20 plasmids expressing YFP-fused wildtype GBF1 (GBF1wt), M832L BFA-resistant GBF1
21 mutant (GBF1ML) or E794K inactive GBF1 mutant (GBF1EK). A plasmid expressing only
22 the YFP protein was used as a control (YFP). Two days post-transfection, expression levels of
23 YFP-fused GBF1 proteins and YFP protein were controlled by western blotting (**Figure 4A**)
24 and fluorescent microscopy (**Figure 4B**), and transfected with the full-length infectious p6
25 RNA (**Figure 4C**). Cells were next treated for 16h with 75 ng/ml BFA, a concentration that

1 inhibits approximately 60% of the HEV replication. It has to be noted that BFA treatment had
2 no impact on the subcellular localisation of GBF1 proteins (**Figure 4B**). Four days p.e., cells
3 were fixed and analysed by immunofluorescence with an anti-ORF2 capsid protein antibody,
4 as described in Figure 1. For each transfection, control DMSO values were set to 100% and
5 the corresponding percentage was calculated for the BFA treatment condition. As shown in
6 **Figure 4C**, upon treatment with BFA, the number of ORF2-positive cells was reduced by
7 approximately 50% in cells transfected with YFP and GBF1EK mutant. In contrast,
8 overexpression of GBF1wt led to an increase of 20% in the number of ORF2-positive cells
9 and the expression of the BFA-resistant mutant M832L restored more than 35% of HEV
10 replication, as compared to DMSO treated cells, indicating a protective effect of functional
11 GBF1 overexpression over BFA-induced inhibition of HEV replication.

12

13 **GBF1 is likely required for the activity of HEV replication complexes and not for their**
14 **assembly.**

15 Several viruses of the *Picornaviridae*, *Coronaviridae* and *Flaviviridae* families rely on GBF1
16 for their replication (Verheije *et al.*, 2008; Belov *et al.*, 2008; Lanke *et al.*, 2009; Goueslain *et*
17 *al.*, 2010; van der Linden *et al.*, 2010; Wang *et al.*, 2014; Qin *et al.*, 2014; Carpp *et al.*, 2014;
18 Liang *et al.*, 2017). However, it has been shown that GBF1 is not involved in the formation of
19 Poliovirus, MHV and HCV replication complexes but rather in their maturation or activity
20 (Verheije *et al.*, 2008; Belov *et al.*, 2008; Goueslain *et al.*, 2010). In order to investigate how
21 GBF1 is involved in HEV replication, we next performed time-course experiments in which
22 BFA was added for 16h at various time points (0, 24h and 48h) after electroporation, and
23 replication levels were measured at 24, 48 and 72h p.e. (**Figure 5**). A strong inhibition of
24 HEV replication by BFA was observed whatever the time of addition of the drug, even when
25 BFA was added 48h p.e., indicating that BFA is able to inhibit HEV replication in cells in

1 which replication complexes are already formed. Together, these results suggest that GBF1 is
2 required for the activity of HEV replication complexes and not for their assembly.

3

4 **Subcellular localisation of GBF1 in HEV-replicating cells and HEV ORF1-expressing** 5 **cells.**

6 Since we demonstrated that GBF1 is a cellular factor required for HEV replication, we next
7 analysed GBF1 subcellular localisation in HEV-replicating PLC3 cells using
8 immunofluorescence confocal microscopy (**Figure 6**). Due to the lack of tools to probe ORF1
9 protein in HEV-replicating cells (Lenggenhager *et al.*, 2017), co-localisation studies of GBF1
10 with the HEV replicase could not be performed. Therefore, non-transfected PLC3 cells and
11 cells transfected with the full-length infectious p6 clone were co-stained with antibodies
12 directed against GBF1 and the ORF2 capsid protein. As expected, in non-transfected PLC3
13 cells, GBF1 staining was observed in Golgi-like perinuclear structures and in cytoplasmic
14 small dot-like structures (**Figure 6**, PLC3). Similar intracellular GBF1 distributions were
15 observed in HEV-replicating cells (**Figure 6**, PLC3/HEV-p6), indicating that the major
16 subcellular localisation of GBF1 is not modified upon HEV replication and therefore is likely
17 not recruited and stably maintained on HEV replication complexes. The same results were
18 obtained in transfected Huh-7.5 cells (data not shown). As an alternative approach to
19 determining whether GBF1 is recruited to the replication sites, we analyzed the subcellular
20 localisation of GBF1 in cells overexpressing the non-structural ORF1 polyprotein in
21 combination or not with the structural ORF2 and ORF3 proteins (**Figure 7**). The ORF1
22 protein was detected with three different antibodies directed against either the methyl
23 transferase (Met), the helicase d (Hel) or the polymerase (Pol) domain. We observe no
24 difference in the localisation of GBF1 upon expression of the viral proteins. In addition,

- 1 GBF1 and ORF1 did not co-stain regardless of the antibody used, strengthening our
- 2 hypothesis that GBF1 is probably not recruited to HEV replication sites.
- 3

1 **DISCUSSION**

2 Due to difficulties to amplify HEV in cell culture and the absence of tools to analyse HEV
3 non-structural proteins, mechanisms leading to HEV replication are particularly poorly
4 understood. The site of RNA replication within the host cell has not been identified yet.
5 However, the use of vector systems showed that the non-structural ORF1 polyprotein might
6 be membrane-associated and localized in the ERGIC, suggesting that HEV replication might
7 occur within the early secretory pathway (Perttilä *et al.*, 2013). In our study, we show that
8 activity of HEV replication complexes strongly depends on GBF1, a GEF regulating the
9 activity of Arf small G-proteins, which in turn are key regulators of the cellular secretory
10 pathway. We demonstrate that BFA and GCA, a specific inhibitor of GBF1, inhibit HEV
11 replication and that GBF1 is the only BFA-sensitive cellular factor required for HEV
12 replication.

13 GBF1 orchestrates retrograde Golgi-to-ER transport by activating Arf proteins that regulate
14 COPI-coated vesicles transport (D'Souza-Schorey and Chavrier, 2006). GBF1 also
15 participates in Golgi morphogenesis and lipid droplet metabolism (Jackson and Bouvet,
16 2014). In addition, GBF1 is hijacked by several positive-strand RNA viruses including
17 *Picornaviridae*, *Coronaviridae* and *Flaviviridae* members for their replication (Verheije *et*
18 *al.*, 2008; Belov *et al.*, 2008; Lanke *et al.*, 2009; Goueslain *et al.*, 2010; van der Linden *et al.*,
19 2010; Wang *et al.*, 2014; Qin *et al.*, 2014; Carpp *et al.*, 2014; Liang *et al.*, 2017). For
20 instance, GBF1 was shown to interact with Poliovirus and Coxsackievirus B3 (CVB3)
21 nonstructural protein 3A (Wessels *et al.*, 2006; Wessels *et al.*, 2007). GBF1 overexpression
22 rescues enterovirus replication in cells treated with BFA, whereas its silencing strongly
23 inhibits viral replication (Belov *et al.*, 2008; Lanke *et al.*, 2009). The precise role of GBF1 in
24 enterovirus replication is not clear. It has been proposed that Arf-activating function of GBF1
25 would be necessary for enterovirus replication to recruit other cellular factors supporting

1 replication such as the phosphatidylinositol kinase PI4KIII (Hsu *et al.*, 2010). However, more
2 recent data suggest that enterovirus replication requires the N-terminal region of the GBF1
3 protein but not its Arf-GEF activity (Belov *et al.*, 2010; Viktorova *et al.*, 2015). In contrast,
4 GBF1-mediated Arf1 activation is crucial for mouse hepatitis coronavirus (MHV) RNA
5 replication (Verheije *et al.*, 2008). GBF1 is also a host factor required for HCV replication
6 (Goueslain *et al.*, 2010). In contrast to enteroviruses, no interaction between GBF1 and viral
7 proteins has been reported so far. In addition, it has been shown recently that the role of
8 GBF1 in HCV replication is mediated by its Arf-GEF activity (Farhat *et al.*, 2016).
9 Interestingly, Arf4 and Arf5 were shown to be essential for mediating GBF1 function in HCV
10 replication, yet depletion of these two Arf proteins did not inhibit the secretory pathway,
11 instead affecting lipid metabolism (Farhat *et al.*, 2016). In our study, we demonstrate that
12 GBF1 has essential functions in HEV replication. Further experiments using Arf protein
13 expression knockdown, and mutants of the catalytic Sec7 domain of GBF1 (Farhat *et al.*,
14 2016), are now necessary to define the importance of Arf-GEF activity of GBF1 in HEV
15 replication.

16 Many positive-strand RNA viruses manipulate the internal membranes of host cells to
17 establish their replication complexes, frequently on the cytosolic leaflet of remodeled
18 membranes. This compartmentalization allows coordination of the different steps of the
19 replication cycle, resulting in highly efficient RNA replication as well as protection of the
20 viral genome from cell defense mechanisms. These remodelled membranes are characterized
21 by two different types of membrane structures: the invaginated vesicle or spherule type
22 induced for instance by Dengue virus and the double membrane vesicle induced for instance
23 by Poliovirus and HCV (reviewed in (Paul, 2013)). To induce and maintain such membrane
24 rearrangements, viruses usurp cellular factors that are active on membranes. For instance,
25 enteroviruses recruit Arf GEFs to rearrange Golgi and ERGIC membranes (Belov *et al.*,

1 2006) and ER-resident reticulon proteins (Tang *et al.*, 2007), whereas alphaviruses subvert
2 amphiphysins localized at the plasma membrane for membrane remodeling and viral RNA
3 replication (Neuvonen *et al.*, 2011). As mentioned previously, GBF1 is essential for the
4 replication of enteroviruses, coronaviruses and flaviviruses, all of which are viruses inducing
5 remodeling of intracellular membranes. In the present study, we demonstrated that GBF1 is a
6 cellular factor required for the activity of HEV replication complexes. Based on the fact that
7 viruses using GBF1 for their replication induce membrane rearrangements, we can therefore
8 speculate that HEV replication might depend on such membrane reshuffling. Further studies
9 using electron microscopy of cells highly replicating the HEV genome are thus required to
10 test this hypothesis.

11 In order to determine whether GBF1 is recruited by the ORF1 protein at replication
12 complexes, as observed for Poliovirus and CVB3 nonstructural protein 3A (Wessels *et al.*,
13 2006; Wessels *et al.*, 2007), we analyzed the subcellular distribution of GBF1. However,
14 although the full-length protein or domains of the non-structural ORF1 protein can be
15 detected by antibodies in cells transfected with vector systems (Perttilä *et al.*, 2013;
16 Lenggenhager *et al.*, 2017), these antibodies fail to detect ORF1 protein in HEV-replicating
17 cells (data not shown and (Lenggenhager *et al.*, 2017)). This lack of tools directed against
18 ORF1 prevents us from analyzing whether GBF1 is recruited to replication complexes in
19 HEV-replicating cells. As an indirect approach, we first analyzed the subcellular distribution
20 of GBF1 in HEV replicating and non-replicating cells and found no evidence of a change in
21 its intracellular localization. As a second alternative approach, we studied the subcellular
22 distribution of GBF1 in cells overexpressing the ORF1 viral replicase and found that GBF1
23 intracellular pattern was unaffected by viral protein expression. In addition, we did not find
24 any evidence of GBF1-ORF1 co-localisation. These results suggest that, as for its
25 involvement in HCV replication, GBF1 might have an indirect role in HEV replication by

1 activating effectors involved in HEV replication. However, further experiments of co-staining
2 of ORF1 protein and GBF1 in HEV-replicating cells are needed to elucidate the involvement
3 of GBF1 in HEV replication. The development of tools allowing the probing of ORF1 protein
4 in HEV-replicating cells is thus essential to characterize the mechanisms of HEV replication
5 and the involvement of GBF1.

6 In conclusion, our results highlight a functional connection between HEV RNA replication
7 and the early secretory pathway of the host cell. Identifying more precisely the function of
8 GBF1 in HEV replication and a potential effect of HEV replication on intracellular
9 membranes should also provide new insights into the understanding of cellular mechanisms
10 underlying HEV RNA replication.

11

1 **EXPERIMENTAL PROCEDURES**

2 **Chemicals and reagents.** Dulbecco's modified Eagle's medium (DMEM), phosphate
3 buffered saline (PBS), fetal calf serum (FCS) and 4',6-diamidino-2-phenylindole (DAPI) were
4 purchased from Life Technologies. Mowiol 4-88 and Golgicide A were from Calbiochem.
5 Protease inhibitors cocktail (Complete) was from Roche. Sofosbuvir was purchased from
6 Selleckchem (Houston, USA). Other chemicals were from Sigma.

7 **Cell culture.** Huh-7 (Nakabayashi *et al.*, 1982), Huh-7.5 (Blight *et al.*, 2002), R2 (Farhat *et*
8 *al.*, 2013) and PLC3 (Montpellier *et al.*, 2017) cells were grown in DMEM supplemented
9 with 2 mM glutamax-I and 10% inactivated FCS (DMEM/FCS) at 37°C / 5% CO₂.

10 The Huh-7-derived H7T7IZ cells stably expressing the T7 RNA polymerase (Romero-Brey *et*
11 *al.*, 2012) (kindly provided by Volker Lohmann and Ralf Bartenschlager, University of
12 Heidelberg, Germany) were used for the transfection of the T7 promoter-driven expression
13 vectors, pTM-ORF1 and pTM-ORF2/3 plasmids, allowing the expression of ORF1 and
14 ORF2/3, respectively (Lenggenhager *et al.*, 2017).

15

16 **Antibodies.** Rabbit anti-HEV ORF1 polyclonal antibodies against the methyltransferase
17 (Met), the helicase (Hel) and the polymerase domain (Pol) were kindly provided by Tero
18 Ahola (University of Helsinki, Finland) (Perttilä *et al.*, 2013). Mouse anti-HEV ORF2 MAb
19 (1E6/IgG2b, antibody registry #AB-827236) was from Millipore. Mouse anti-GFP mAb was
20 from Roche. Rabbit anti-BIG1 and BIG2 antibodies were from Bethyl Laboratories. Mouse
21 anti-GBF1 (IgG1, antibody registry #AB-399487) was from BD Biosciences. Mouse anti- β
22 tubulin was from Sigma. Secondary antibodies were from Jackson ImmunoResearch.

23

24 **Viability Assay.** Sub-confluent cell cultures grown in 96-well plates were incubated with

1 BFA, GCA or DMSO for 16h, or incubated all the time with Sofosbuvir, and kept in culture
2 for 24, 48 or 72h. A MTS [3-(4,5-dimethylthiazol-2-yl)-5- (3-carboxymethoxyphenyl)-2-(4-
3 sulfophenyl)-2H-tetrazolium] based viability assay (CellTiter 96 aqueous nonradioactive cell
4 proliferation assay from Promega) was conducted as recommended by the manufacturer.

5 **Plasmids and transfection.** Plasmids expressing the cell culture adapted gt3 Kernow C-1
6 strain (HEV-p6, GenBank accession number JQ679013), or the replicon expressing the
7 *Gaussia* luciferase gene (p6GLuc) were provided by S.U. Emerson (Shukla *et al.*, 2012). The
8 p6GLuc replicon construct was used to generate a new replicon construct (p6^{SP}GLuc) in
9 which the 20 first amino acids matching with the signal peptide of *Gaussia luciferase* were
10 deleted to block luciferase secretion. Fusion PCR were done with external primers (5'-
11 GCGGGGTCATGCATGGTATT-3', 5'-ACCCATACGTAGCCTGATCG-3') and internal
12 primers (5'-GATCACCATGAAGCCCACCGAGAACAACGA-3', 5'-
13 TGGGCTTCATGGTGATCCCATGGGCGATGC-3'). The gt1 Sar55 strain replicon
14 expressing the *Firefly* luciferase has been described previously (Pudupakam *et al.*, 2009)
15 (kindly provided by X.J. Meng, Virginia Polytechnic Institute and State University,
16 Blacksburg, VA). Capped RNA transcripts were generated with the mMACHINE
17 mMACHINE® kit (Ambion) and delivered into cells by electroporation using a Gene Pulser
18 Xcell™ apparatus (Bio-Rad). Plasmids expressing yellow fluorescent protein (YFP), YFP-
19 tagged GBF1, YFP-tagged GBF1 E794K, or YFP-tagged GBF1 M832L have been described
20 previously (Niu *et al.*, 2005; Goueslain *et al.*, 2010).

21 **Luciferase assays.** 2x10⁶ cells were electroporated with 2.5 µg of p6^{SP}GLuc or Sar55FLuc
22 RNA and seeded in P24 wells plate. Drugs (BFA, GCA or Sofosbuvir) were added 2h post-
23 electroporation (p.e.) and kept for 16h. At 6h, 24h, 48h and 72h p.e., cells were lysed with the
24 buffer provided by the manufacturer (Promega) and *Gaussia* or *Firefly* luciferase activities
25 were determined with the corresponding luciferase assay system (Promega) and using a

1 TriStar LB941 luminometer (Berthold). Luciferase activities at 6h p.e. were used to determine
2 electroporation efficiencies.

3
4 **RNA interference.** RNA interference experiments were carried out with pools of four
5 different synthetic double-stranded siRNAs to the same target (on-target plus smart pool
6 reagents from Dharmacon). The control used in this study was the on-target plus non-
7 targeting siRNA #1 (D-001810-01-20). For siRNA transfection, 3 μ l of lipofectamine RNAi
8 MAX (Life Technologies) was added to 0.5 ml of D-PBS and incubated for 3 min. In a 6-well
9 plate, 2.5 μ l of siRNA at 20 μ M was spotted in the center of a well. In case of double siRNA
10 transfection, 1.25 μ l of each siRNA was used. Then, the diluted transfection reagent was
11 added to the siRNA, and the mixture was incubated for 30 min at room temperature. At the
12 end of this incubation, 2.5×10^5 freshly trypsinized cells in a volume of 2ml of culture medium
13 were added to the transfection mix, and the cells were returned to 37°C. Two days post-
14 transfection, cells were trypsinized and p6^{SP}GLuc replicon RNA was electroporated, as
15 described previously.

16
17 **GBF1 complementation.** Huh-7.5 cells seeded in 6-well plates were transfected with 0.5 μ g
18 of plasmids expressing YFP-fused wildtype GBF1, YFP-fused mutant GBF1 or YFP protein
19 with the Trans-IT LT1 reagent following the instructions of the manufacturer (Mirus). Two
20 days post-transfection, expression of GBF1 proteins was controlled by WB and fluorescence
21 microscopy. Cells were then electroporated with the infectious full-length p6 RNA and
22 cultured for 16h in the presence of BFA (75 ng/ml). At 96h post-electroporation, cells were
23 fixed with methanol and stained with an anti-ORF2 antibody (1E6). For each transfection
24 with GBF1 proteins or YFP, ORF2-positive cells values were adjusted to 100% for cells
25 cultured in the presence of DMSO.

1
2
3
4
5
6
7
8
9
10
11
12
13
14
15
16
17
18
19
20

Immunoblotting. Transfected cells were rinsed three times with cold PBS and lysed at 4°C for 20min in a buffer containing 50mM TrisCl, 100mM NaCl, 2mM EDTA, 1% Triton-X, 0.1% SDS, pH 7.5, 1mM PMSF and a protease inhibitors cocktail (Complete). Insoluble material was removed by centrifugation at 4°C. The proteins were resolved by SDS-PAGE and transferred onto nitrocellulose membranes (Hybond-ECL; Amersham) using a Trans-Blot apparatus (Bio-Rad). Proteins of interest were revealed with specific primary antibodies, followed by species-specific secondary antibodies conjugated to peroxidase. Proteins were visualized using enhanced chemiluminescence (ECL Plus; GE healthcare). The signals were recorded using a LAS 3000 apparatus (Fujifilm).

Immunofluorescence microscopy. Indirect immunofluorescence labelling was performed as previously described (Rouille *et al.*, 2006). Nuclei were stained with DAPI. Cells transfected with the full-length p6 RNA were stained with a mouse anti-ORF2 MAb (1E6) and positive cells were counted for each condition.

For confocal microscopy analyses, PLC3 cells transfected with the full-length p6 RNA were co-stained with GBF1 and ORF2 antibodies. H7T7IZ cells transfected with pTM-ORF1 or in combination with pTM-ORF2/3 were co-stained with GBF1 and ORF1 Met, Hel or Pol domain antibodies.

1 REFERENCES

- 2 Belov, G.A., Altan-Bonnet, N., Kovtunovych, G., Jackson, C.L., Lippincott-Schwartz, J., and
3 Ehrenfeld, E. (2006) Hijacking Components of the Cellular Secretory Pathway for
4 Replication of Poliovirus RNA. *J Virol* **81**: 558–567.
- 5 Belov, G.A., Feng, Q., Nikovics, K., Jackson, C.L., and Ehrenfeld, E. (2008) A critical role of
6 a cellular membrane traffic protein in poliovirus RNA replication. *PLoS Pathog* **4**: e1000216.
- 7 Belov, G.A., Kovtunovych, G., Jackson, C.L., and Ehrenfeld, E. (2010) Poliovirus replication
8 requires the N-terminus but not the catalytic Sec7 domain of ArfGEF GBF1. *Cell Microbiol*
9 **12**: 1463–1479.
- 10 Blight, K.J., Mckeating, J.A., and Rice, C.M. (2002) Highly Permissive Cell Lines for
11 Subgenomic and Genomic Hepatitis C Virus RNA Replication. *J Virol* **76**: 13001–13014.
- 12 Carpp, L.N., Rogers, R.S., Moritz, R.L., and Aitchison, J.D. (2014) Quantitative proteomic
13 analysis of host-virus interactions reveals a role for Golgi brefeldin A resistance factor 1
14 (GBF1) in dengue infection. *Mol Cell Proteomics* **13**: 2836–2854.
- 15 D'Souza-Schorey, C., and Chavrier, P. (2006) ARF proteins: roles in membrane traffic and
16 beyond. *Nat Rev Mol Cell Biol* **7**: 347–358.
- 17 Dao Thi, V.L., Debing, Y., Wu, X., Rice, C.M., Neyts, J., Moradpour, D., and Gouttenoire, J.
18 (2016) Sofosbuvir Inhibits Hepatitis E Virus Replication In Vitro and Results in an Additive
19 Effect When Combined With Ribavirin. *Gastroenterology* **150**: 82–85.e4.
- 20 Debing, Y., Moradpour, D., Neyts, J., and Gouttenoire, J. (2016) Update on hepatitis E
21 virology: Implications for clinical practice. *Journal of Hepatology* **65**: 200–212.
- 22 Doceul, V., Bagdassarian, E., Demange, A., and Pavio, N. (2016) Zoonotic Hepatitis E Virus:
23 Classification, Animal Reservoirs and Transmission Routes. *Viruses* **8**: 270.
- 24 Farhat, R., Goueslain, L., Wychowski, C., Belouzard, S., Fénéant, L., Jackson, C.L., *et al.*
25 (2013) Hepatitis C virus replication and Golgi function in brefeldin a-resistant hepatoma-
26 derived cells. *PLoS ONE* **8**: e74491.
- 27 Farhat, R., Séron, K., Ferlin, J., Fénéant, L., Belouzard, S., Goueslain, L., *et al.* (2016)
28 Identification of class II ADP-ribosylation factors as cellular factors required for hepatitis C
29 virus replication. *Cell Microbiol* **18**: 1121–1133.
- 30 Gillingham, A.K., and Munro, S. (2007) The Small G Proteins of the Arf Family and Their
31 Regulators. *Annu Rev Cell Dev Biol* **23**: 579–611.
- 32 Goueslain, L., Alsaleh, K., Horellou, P., Roingeard, P., Descamps, V., Duverlie, G., *et al.*
33 (2010) Identification of GBF1 as a cellular factor required for hepatitis C virus RNA
34 replication. *J Virol* **84**: 773–787.
- 35 Holla, R., Ahmad, I., Ahmad, Z., and Jameel, S. (2013) Molecular Virology of Hepatitis E
36 Virus. *Semin Liver Dis* **33**: 003–014.
- 37 Hsu, N.-Y., Ilnytska, O., Belov, G., Santiana, M., Chen, Y.-H., Takvorian, P.M., *et al.* (2010)

- 1 Viral reorganization of the secretory pathway generates distinct organelles for RNA
2 replication. *Cell* **141**: 799–811.
- 3 Jackson, C.L., and Bouvet, S. (2014) Arfs at a glance. *J Cell Sci* **127**: 4103–4109.
- 4 Jackson, C.L., and Casanova, J.E. (2000) Turning on ARF: the Sec7 family of guanine-
5 nucleotide-exchange factors. *Trends in Cell Biology* **10**: 60–67.
- 6 Kamar, N., Marion, O., Abravanel, F., Izopet, J., and Dalton, H.R. (2016) Extrahepatic
7 manifestations of hepatitis E virus. *Liver Int* **36**: 467–472.
- 8 Klausner, R.D., Donaldson, J.G., and Lippincott-Schwartz, J. (1992) Brefeldin A: insights
9 into the control of membrane traffic and organelle structure. *J Cell Biol* **116**: 1071–1080.
- 10 Koonin, E.V., Gorbalenya, A.E., Purdy, M.A., Rozanov, M.N., Reyes, G.R., and Bradley,
11 D.W. (1992) Computer-assisted assignment of functional domains in the nonstructural
12 polyprotein of hepatitis E virus: delineation of an additional group of positive-strand RNA
13 plant and animal viruses. *Proc Natl Acad Sci USA* **89**: 8259–8263.
- 14 Lanke, K.H.W., van der Schaar, H.M., Belov, G.A., Feng, Q., Duijsings, D., Jackson, C.L., *et*
15 *al.* (2009) GBF1, a guanine nucleotide exchange factor for Arf, is crucial for coxsackievirus
16 B3 RNA replication. *J Virol* **83**: 11940–11949.
- 17 Lenggenhager, D., Gouttenoire, J., Malehmir, M., Bawohl, M., Honcharova-Biletska, H.,
18 Kreutzer, S., *et al.* (2017) Visualization of hepatitis E virus RNA and proteins in the human
19 liver. *Journal of Hepatology* **67**: 471–479.
- 20 Liang, W., Zheng, M., Bao, C., and Zhang, Y. (2017) CSFV proliferation is associated with
21 GBF1 and Rab2. *J Biosci* **42**: 43–56.
- 22 Montpellier, C., Wychowski, C., Sayed, I.M., Meunier, J.-C., Saliou, J.-M., Ankavay, M., *et*
23 *al.* (2017) Hepatitis E Virus Lifecycle and Identification of 3 Forms of the ORF2 Capsid
24 Protein. *Gastroenterology*. 10.1053/j.gastro.2017.09.020
- 25 Nakabayashi, H., Taketa, K., Miyano, K., Yamane, T., and Sato, J. (1982) Growth of human
26 hepatoma cells lines with differentiated functions in chemically defined medium. *Cancer Res*
27 **42**: 3858–3863.
- 28 Neuvonen, M., Kazlauskas, A., Martikainen, M., Hinkkanen, A., Ahola, T., and Saksela, K.
29 (2011) SH3 Domain-Mediated Recruitment of Host Cell Amphiphysins by Alphavirus nsP3
30 Promotes Viral RNA Replication. *PLoS Pathog* **7**: e1002383.
- 31 Niu, T.-K., Pfeifer, A.C., Lippincott-Schwartz, J., and Jackson, C.L. (2005) Dynamics of
32 GBF1, a Brefeldin A-sensitive Arf1 exchange factor at the Golgi. *Mol Biol Cell* **16**: 1213–
33 1222.
- 34 Paul, D. (2013) Architecture and biogenesis of plus-strand RNA virus replication factories.
35 *WJV* **2**: 32.
- 36 Perttilä, J., Spuul, P., and Ahola, T. (2013) Early secretory pathway localization and lack of
37 processing for hepatitis E virus replication protein pORF1. *Journal of General Virology* **94**:
38 807–816.

- 1 Pudupakam, R.S., Huang, Y.W., Opriessnig, T., Halbur, P.G., Pierson, F.W., and Meng, X.J.
2 (2009) Deletions of the hypervariable region (HVR) in open reading frame 1 of hepatitis E
3 virus do not abolish virus infectivity: evidence for attenuation of HVR deletion mutants in
4 vivo. *J Virol* **83**: 384–395.
- 5 Qin, Y., Lin, L., Chen, Y., Wu, S., Si, X., Wu, H., *et al.* (2014) Curcumin inhibits the
6 replication of enterovirus 71 in vitro. *Acta Pharm Sin B* **4**: 284–294.
- 7 Romero-Brey, I., Merz, A., Chiramel, A., Lee, J.-Y., Chlanda, P., Haselman, U., *et al.* (2012)
8 Three-dimensional architecture and biogenesis of membrane structures associated with
9 hepatitis C virus replication. *PLoS Pathog* **8**: e1003056.
- 10 Rouille, Y., Helle, F., Delgrange, D., Roingeard, P., Voisset, C., Blanchard, E., *et al.* (2006)
11 Subcellular localization of hepatitis C virus structural proteins in a cell culture system that
12 efficiently replicates the virus. *J Virol* **80**: 2832–2841.
- 13 Sayed, I.M., Vercouter, A.-S., Abdelwahab, S.F., Vercauteren, K., and Meuleman, P. (2015)
14 Is hepatitis E virus an emerging problem in industrialized countries? *Hepatology* **62**: 1883–
15 1892.
- 16 Sáenz, J.B., Sun, W.J., Chang, J.W., Li, J., Bursulaya, B., Gray, N.S., and Haslam, D.B.
17 (2009) Golgicide A reveals essential roles for GBF1 in Golgi assembly and function. *Nat*
18 *Chem Biol* **5**: 157–165.
- 19 Shukla, P., Nguyen, H.T., Faulk, K., Mather, K., Torian, U., Engle, R.E., and Emerson, S.U.
20 (2012) Adaptation of a genotype 3 hepatitis E virus to efficient growth in cell culture depends
21 on an inserted human gene segment acquired by recombination. *J Virol* **86**: 5697–5707.
- 22 Smith, D.B., Simmonds, P., members of the International Committee on the Taxonomy of
23 Viruses Hepeviridae Study Group, Jameel, S., Emerson, S.U., Harrison, T.J., *et al.* (2014)
24 Consensus proposals for classification of the family Hepeviridae. *Journal of General*
25 *Virology* **95**: 2223–2232.
- 26 Tam, A.W., Smith, M.M., Guerra, M.E., Huang, C.C., Bradley, D.W., Fry, K.E., and Reyes,
27 G.R. (1991) Hepatitis E virus (HEV): molecular cloning and sequencing of the full-length
28 viral genome. *Virology* **185**: 120–131.
- 29 Tang, W.F., Yang, S.Y., Wu, B.W., Jheng, J.R., Chen, Y.L., Shih, C.H., *et al.* (2007)
30 Reticulon 3 Binds the 2C Protein of Enterovirus 71 and Is Required for Viral Replication.
31 *Journal of Biological Chemistry* **282**: 5888–5898.
- 32 van der Linden, L., van der Schaar, H.M., Lanke, K.H.W., Neyts, J., and van Kuppeveld,
33 F.J.M. (2010) Differential effects of the putative GBF1 inhibitors Golgicide A and AG1478
34 on enterovirus replication. *J Virol* **84**: 7535–7542.
- 35 Verheije, M.H., Raaben, M., Mari, M., Lintelo, Te, E.G., Reggiori, F., van Kuppeveld,
36 F.J.M., *et al.* (2008) Mouse hepatitis coronavirus RNA replication depends on GBF1-
37 mediated ARF1 activation. *PLoS Pathog* **4**: e1000088.
- 38 Viktorova, E.G., Nchoutmboube, J., Ford-Siltz, L.A., and Belov, G.A. (2015) Cell-specific
39 establishment of poliovirus resistance to an inhibitor targeting a cellular protein. *J Virol* **89**:
40 4372–4386.

1 Wang, J., Du, J., and Jin, Q. (2014) Class I ADP-ribosylation factors are involved in
2 enterovirus 71 replication. *PLoS ONE* **9**: e99768.

3 Wessels, E., Duijsings, D., Lanke, K.H.W., Melchers, W.J.G., Jackson, C.L., and van
4 Kuppeveld, F.J.M. (2007) Molecular Determinants of the Interaction between Coxsackievirus
5 Protein 3A and Guanine Nucleotide Exchange Factor GBF1. *J Virol* **81**: 5238–5245.

6 Wessels, E., Duijsings, D., Lanke, K.H.W., van Dooren, S.H.J., Jackson, C.L., Melchers,
7 W.J.G., and van Kuppeveld, F.J.M. (2006) Effects of Picornavirus 3A Proteins on Protein
8 Transport and GBF1-Dependent COP-I Recruitment. *J Virol* **80**: 11852–11860.

9

10

1 **ACKNOWLEDGMENTS**

2

3 We thank S. Ung for his technical assistance. We are grateful to S.U. Emerson, X.J. Meng, V.
4 Lohmann, R. Bartenschlager and T. Ahola for providing us with reagents. We thank A.
5 Weber for his contribution. We thank the imaging core facility of the BioImaging Center
6 Lille-Nord de France for access to the instruments.

7

8

1 **FIGURE LEGENDS**

2

3 **Figure 1: BFA inhibits HEV replication.** (A) Huh-7.5 and PLC3 cells were electroporated
4 with *in vitro*-transcribed p6^{SP}GLuc RNA or Sar55FLuc RNA. Luciferase activities were
5 measured at 6, 24, 48 and 72 hours (h) post-electroporation (p.e.). For each time point, values
6 are presented as fold increase compared to luciferase activities measured at 6h p.e.. (B, C, D)
7 At 6h p.e., HEV-p6^{SP}GLuc-electroporated Huh-7.5 cells were treated for 16h with BFA (B,
8 D) or Sofosbuvir (C) at indicated concentrations. Luciferase activities (B, C) and viability (D)
9 were quantified at 24, 48 and 72h p.e.. Values are presented as a percentage of replication
10 compared to cells treated with 0.2% DMSO. PLC3 cells electroporated with p6^{SP}GLuc RNA
11 (E) and Huh-7.5 cells electroporated with gt1 Sar55FLuc RNA (F) were treated for 16h with
12 BFA at indicated concentrations. Luciferase activities were measured at 24, 48 and 72h p.e..
13 Values are presented as a percentage of replication compared to cells treated with 0.2%
14 DMSO. (G) Huh7.5 cells were electroporated with the full-length infectious p6 strain RNA
15 and then treated with BFA for 16h at indicated concentrations. At 96h post-transfection, cells
16 were fixed and analysed by immunofluorescence with an anti-ORF2 capsid protein antibody.
17 Values were adjusted to 100% infection for non treated cells (Mock). Results are presented as
18 mean \pm SD of three independent experiments. *, ** and *** mean *p* values below 0.05, 0.01
19 and 0.001, respectively.

20

21 **Figure 2: GBF1 is the BFA-sensitive factor required for HEV replication.** (A) Huh7.5
22 cells were transfected with siRNA pools targeting BIG1, BIG2, BIG1 and BIG2 or a non-
23 targeting (NT) siRNA pool. Two days post-transfection, silencing of BIG1, BIG2 or BIG1
24 and BIG2 was controlled by western blotting (WB) with antibodies directed against BIG1 or
25 BIG2. Antibodies directed against Tubulin (Tub) were used to control protein loading. (B)

1 Two days post-transfection, depleted cells were electroporated with the p6^{SP}GLuc replicon
2 and luciferase activities were measured at 24, 48 and 72h p.e.. Values are presented as a
3 percentage of replication compared to cells transfected with NT siRNA pool. (C, D) HEV-
4 p6^{SP}GLuc-electroporated Huh-7.5 cells were treated for 16h with Golgicide A at indicated
5 concentrations. Luciferase activities (C) and viability (D) were quantified at 24, 48 and 72h
6 p.e.. Values are presented as a percentage of replication compared to cells treated with 0.2%
7 DMSO. Results in B, C and D are presented as mean \pm SD of three independent experiments.
8 *** mean *p* values below 0.001.

9
10 **Figure 3: HEV replication in BFA-resistant cells.** Huh-7 cells (A) and BFA-resistant R2
11 cells (B) were electroporated with p6^{SP}GLuc RNA and treated for 16h with BFA at indicated
12 concentrations. Luciferase activities were measured at 24, 48 and 72h p.e.. Values are
13 presented as a percentage of replication compared to cells treated with 0.2% DMSO. Results
14 are presented as mean \pm SD of three independent experiments. *** means *p* values below
15 0.001.

16
17 **Figure 4: GBF1 complementation assay in cells treated with BFA.** Huh-7.5 cells were
18 transfected with a plasmid expressing the YFP protein or with plasmids expressing YFP-fused
19 wildtype GBF1 (GBF1wt), M832L BFA-resistant GBF1 mutant (GBF1ML) or E794K
20 inactive GBF1 mutant (GBF1EK). Two days post-transfection, expression levels of YFP-
21 fused GBF1 proteins and YFP protein were controlled by WB with an anti-GFP antibody (A)
22 and microscopy (B). Expression of constructs in cells treated with BFA (75 ng/ml) is shown
23 in (B). (C) Two days post-transfection, cells were electroporated with the full-length
24 infectious p6 RNA and cultured for 16h in the presence of DMSO or 75 ng/ml BFA. At 96h
25 p.e., cells were fixed and analysed by immunofluorescence with an anti-ORF2 capsid protein

1 antibody. For each construct, the percentage of ORF2-positive cells in BFA-treated cells is
2 compared to cells cultured in the absence of BFA. Results are presented as mean \pm SD of
3 three independent experiments. ** and *** mean p values below 0.01 and 0.001, respectively.

4

5 **Figure 5: Inhibition of HEV replication by BFA in time course experiments.** Huh-7.5

6 cells were electroporated with p6^{SP}GLuc RNA and treated for 16h with BFA (0.1 μ g/ml) at 0
7 (d, e, f), 24 (g, h, i) or 48h (j, k, l) p.e. Luciferase activities were measured at 24, 48 and 72h
8 p.e.. Values are presented as a percentage of replication compared to cells treated with DMSO
9 (a, b, c). Results are presented as mean \pm SD of three independent experiments. *** means p
10 values below 0.001.

11

12 **Figure 6: Intracellular distribution of GBF1 in HEV-replicating and non-replicating**

13 **cells.** PLC3 cells were electroporated with water or with the full-length infectious p6 strain
14 RNA. At 3 days p.e. cells were fixed, permeabilized and processed for double-label
15 immunofluorescence for GBF1 (red) and ORF2 (green). Nuclei are in blue. Representative
16 confocal images are shown together with the merge image.

17

18 **Figure 7: Intracellular distribution of GBF1 in HEV ORF1-expressing cells.** H7T7IZ

19 cells were transfected with pTM-ORF1 or in combination with pTM-ORF2/3. Twenty four
20 hours post-transfection, cells were fixed, permeabilized and processed for double-label
21 immunofluorescence for GBF1 (green) and ORF1 Met, Hel or Pol domain (red). Nuclei are in
22 blue. Representative confocal images are shown together with the merge image.

23

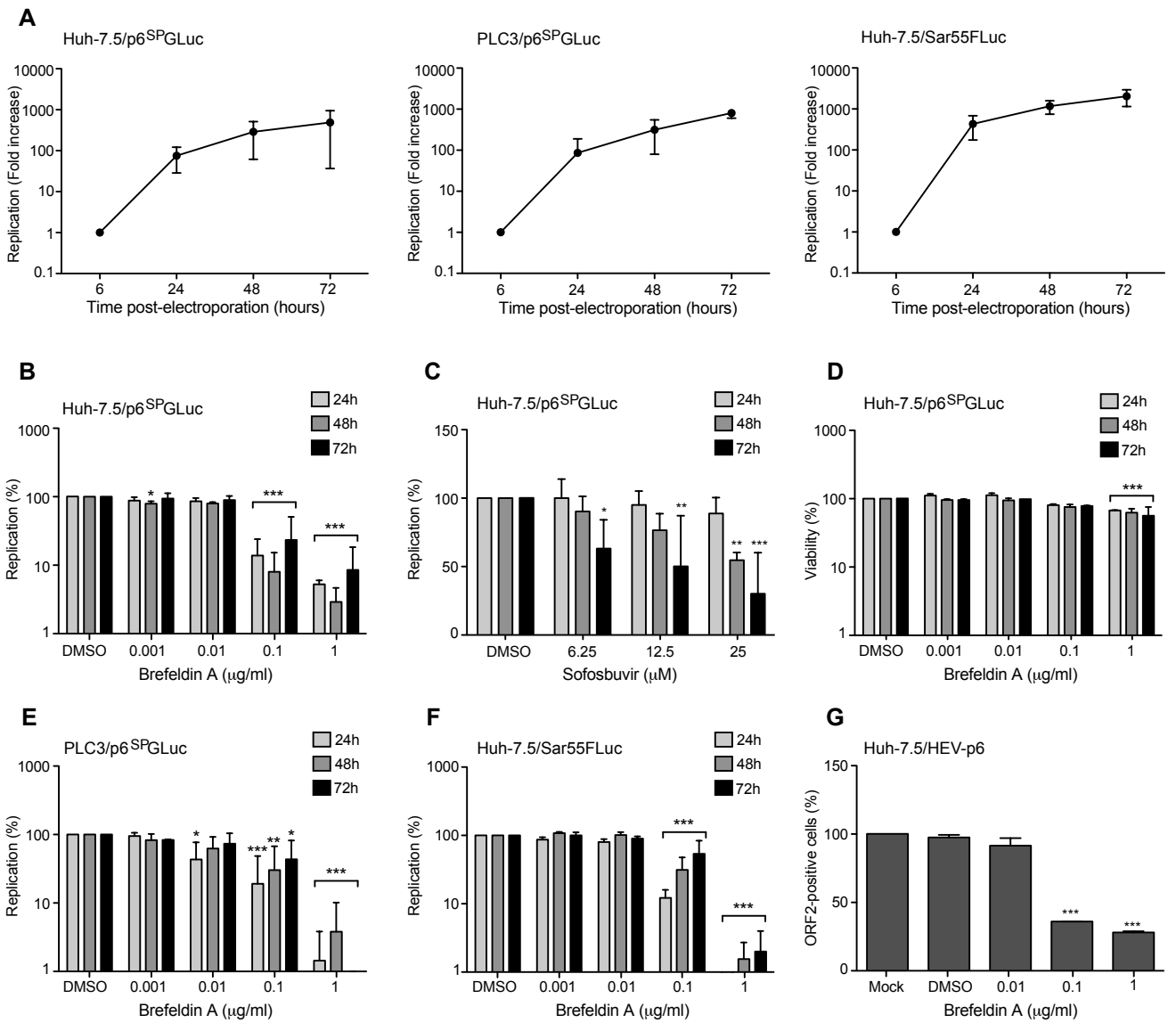

Figure 1

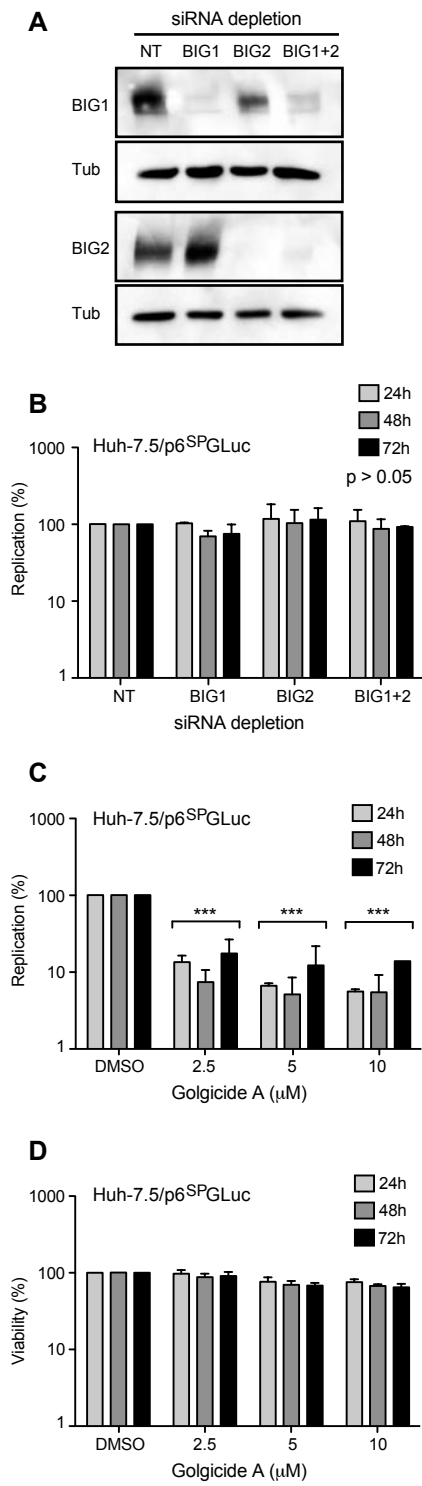

Figure 2

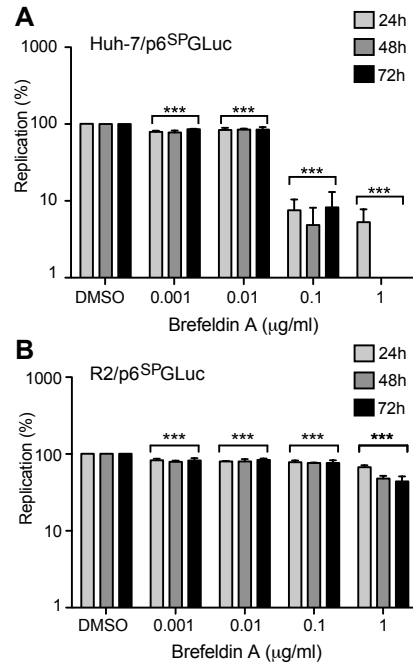

Figure 3

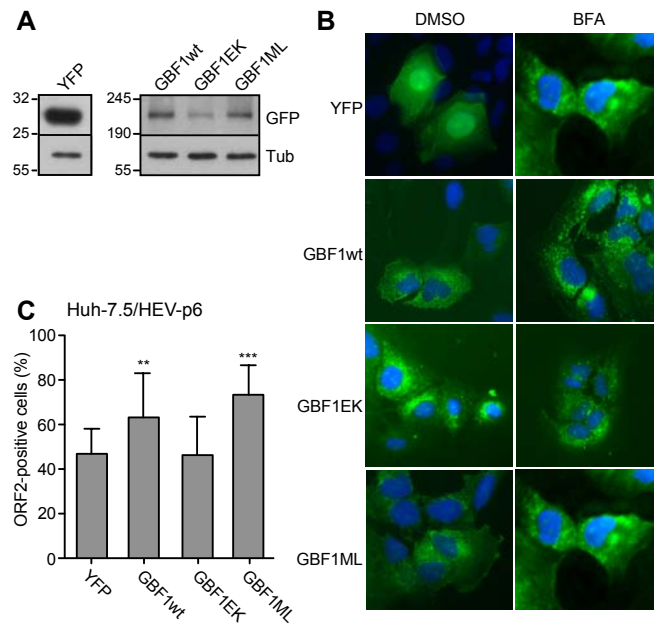

Figure 4

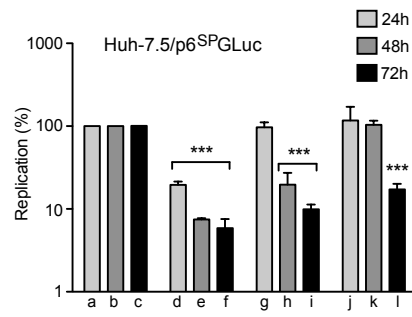
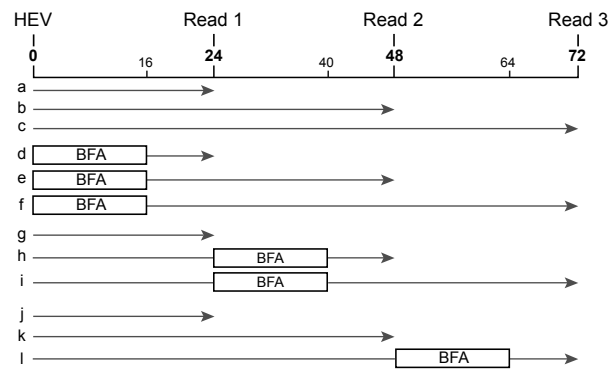

Figure 5

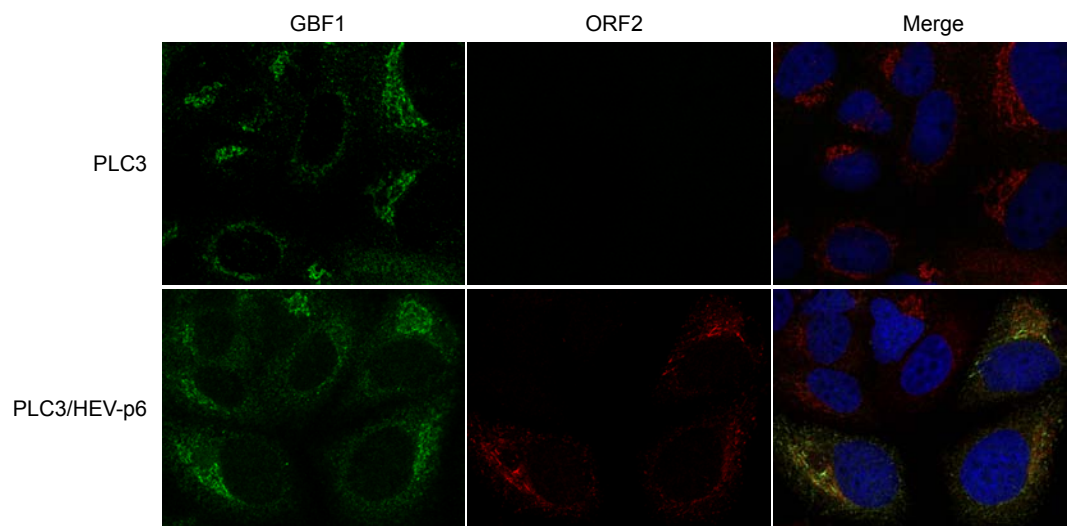

Figure 6

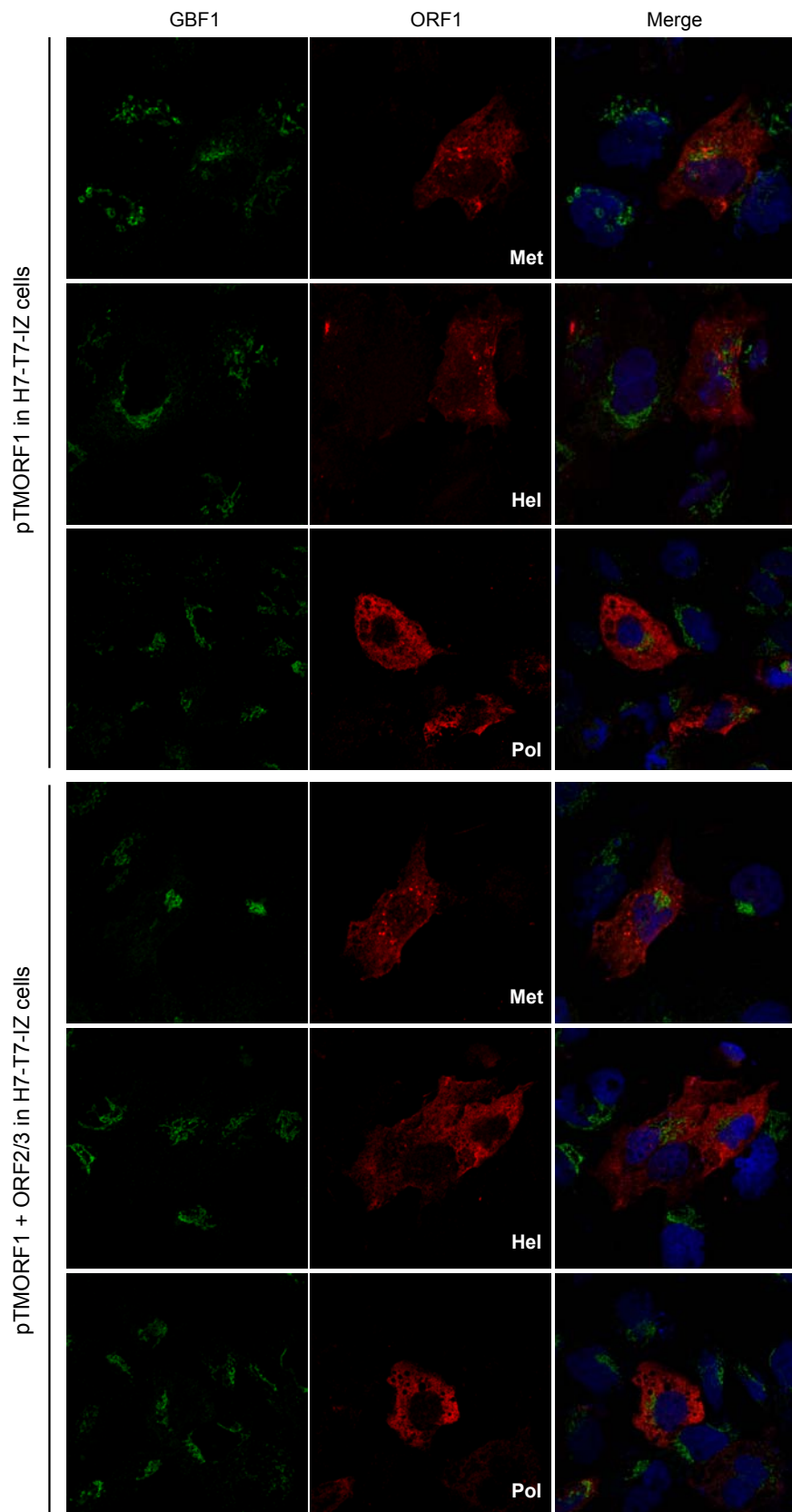

Figure 7