



HAL
open science

Experimental study of the maximum upstream location of premixed CH₄/air and CH₄/O₂-He flames with repetitive extinction and ignition in a quartz micro flow reactor.

H. Chouraqui, C. Chauveau, P. Dagaut, F. Halter, G. Dayma

► To cite this version:

H. Chouraqui, C. Chauveau, P. Dagaut, F. Halter, G. Dayma. Experimental study of the maximum upstream location of premixed CH₄/air and CH₄/O₂-He flames with repetitive extinction and ignition in a quartz micro flow reactor.. 9th European Combustion Meeting (ECM2019), Apr 2019, Lisboa, Portugal. . hal-02111425

HAL Id: hal-02111425

<https://hal.science/hal-02111425>

Submitted on 26 Apr 2019

HAL is a multi-disciplinary open access archive for the deposit and dissemination of scientific research documents, whether they are published or not. The documents may come from teaching and research institutions in France or abroad, or from public or private research centers.

L'archive ouverte pluridisciplinaire **HAL**, est destinée au dépôt et à la diffusion de documents scientifiques de niveau recherche, publiés ou non, émanant des établissements d'enseignement et de recherche français ou étrangers, des laboratoires publics ou privés.

Experimental study of the maximum upstream location of premixed CH₄/air and CH₄/O₂-He flames with repetitive extinction and ignition in a quartz micro flow reactor

H. CHOURAQUI^{1, 2}, C. CHAUVEAU², P. DAGAUT², F. HALTER^{1, 2}, G. DAYMA^{1, 2}

¹ University of Orleans, 1 rue de Chartres, 45067 Orléans cedex 2, France

² CNRS – INSIS, 1C avenue de la Recherche Scientifique, 45071 Orléans cedex 2, France

1. Goal of the study

- Growing need to improve knowledge in the field of small-scale combustion and take advantage of high energy density of fuel [1] in different applications such as portable power device [2], micro-satellite thrusters [3], heat sources [4].
- Previous studies have been done with fuel/air mixtures. Combustion of a CH₄/O₂ mixture with different diluents can improve the understanding of flame behaviour in micro-scale reactor by changing physical properties of the environment. Hence, be able to point out physico-chemical properties that play an important role in micro-scale combustion.

2. Experimental set-up

- Cylindrical quartz tube heated by 3 hydrogen/oxygen blowtorches.
- The temperature profile on the outer side is measured by a infrared camera A655sc.
- A spectroscopy EMCCD camera ProEM 1600 and a Phantom v1611 camera coupled with a High-Speed IRO intensifier with a CH* band-pass filter (20BPF1_430) is used to detect the flame positions.
- CH₄/diluent mixture is supplied in a reactor with an internal diameter smaller than the quenching distance. (Quenching distance of CH₄/air is 2.50 mm)

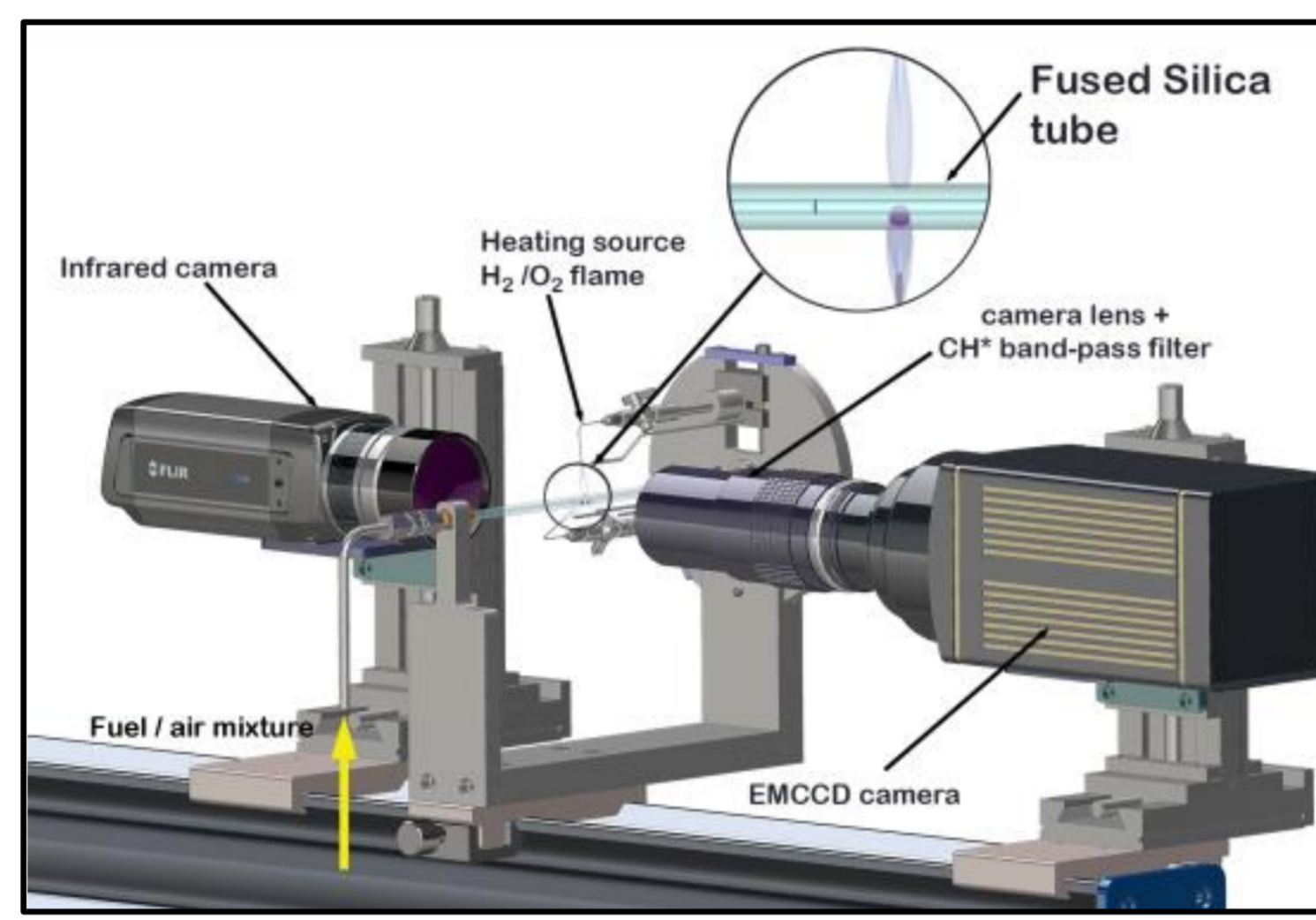

Schematic of the experimental set-up

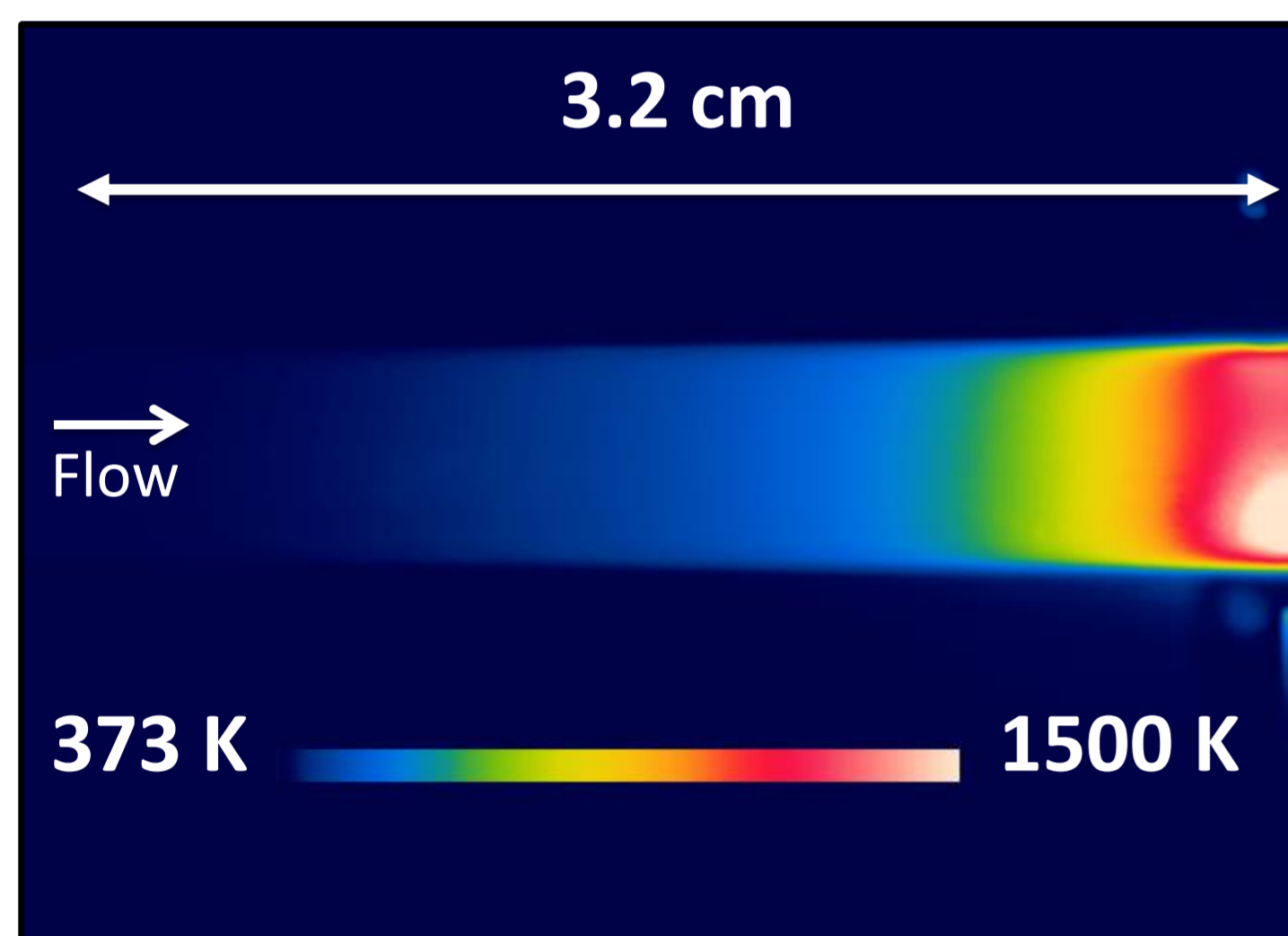
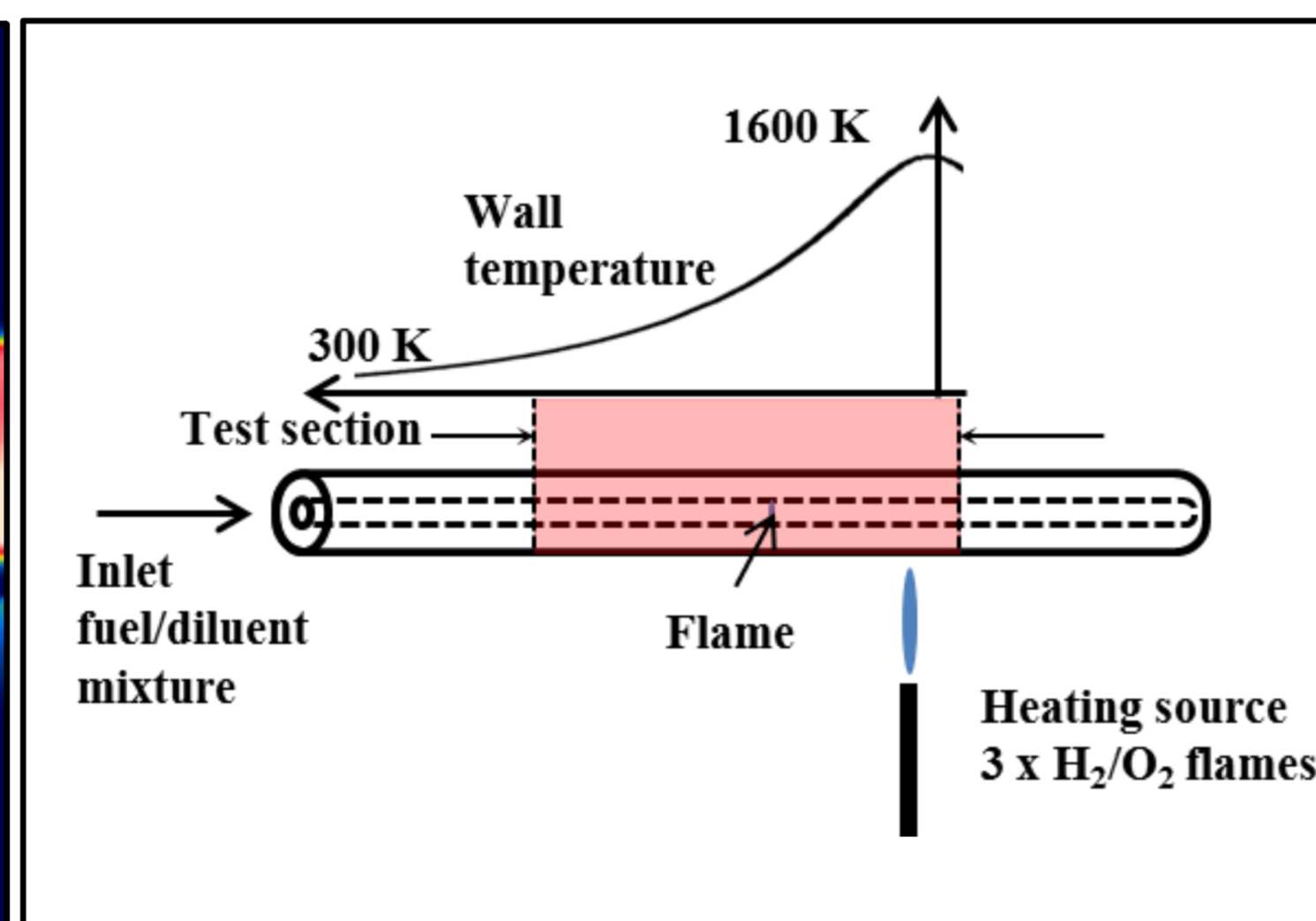

Image from FLIR camera of the external temperature for a stoichiometric mixture of CH₄/air, a flow velocity of 0.7 m/s, in a 1.85 mm internal diameter tube



Schematic of the temperature profile along the channel (test section represented in red has a length of 0.032 m).

3. Flame with Repetitive Extinction and Ignition (FREI)

- The ignition in FREI occurs at the hot wall temperature region near blowtorches. Then the flame front propagates upstream toward fresh gases, reaching a maximum upstream location, until it is finally quenched downstream in colder wall region.

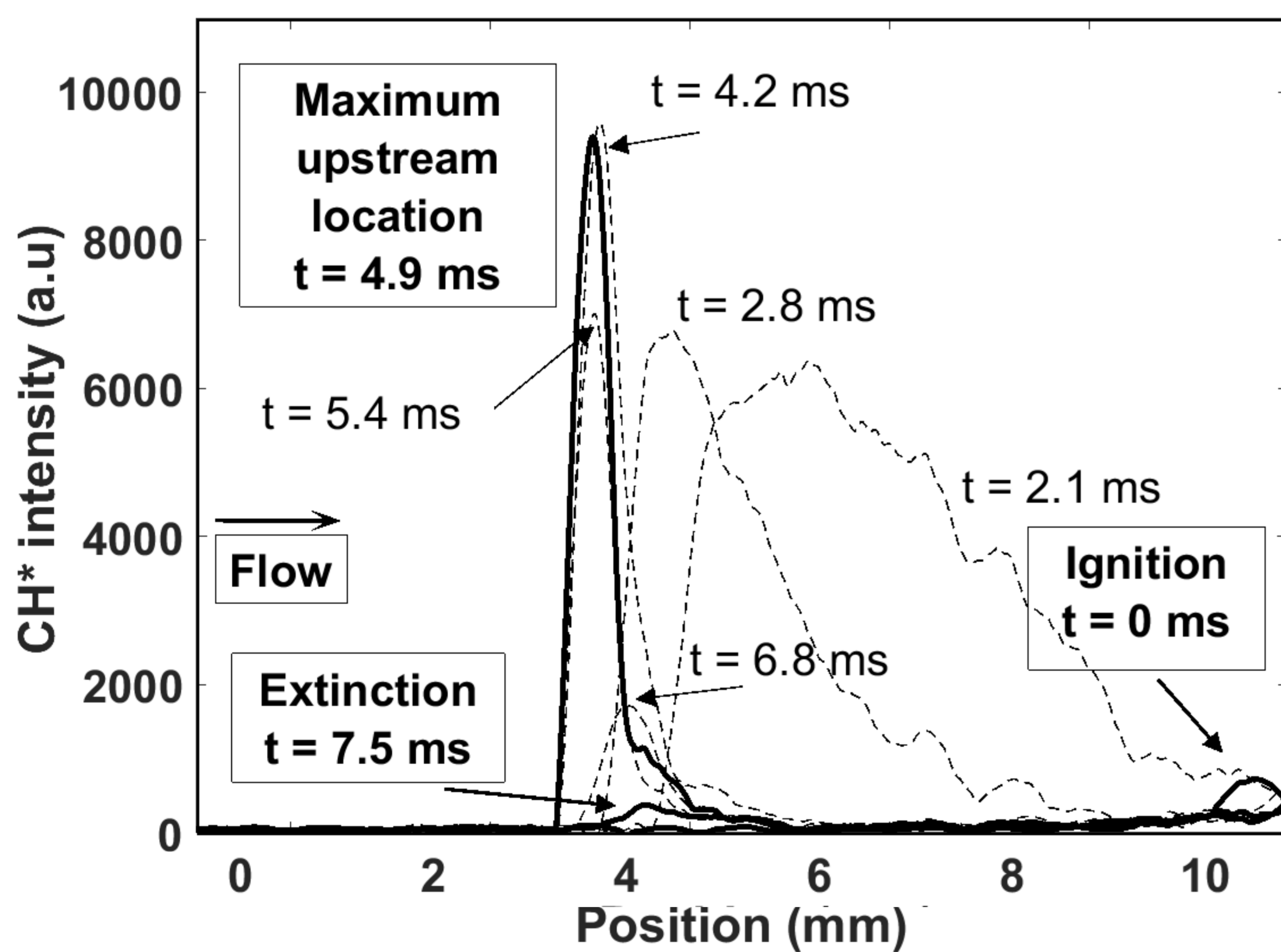

Temporal evolution of CH* intensity obtained during FREI progression of premixed stoichiometric CH₄/air flame with an inlet flow velocity of 0.4 m.s⁻¹ in a 1.85 mm inner diameter reactor [5]

4. Diluent Influence on FREI

Diluent	O ₂	N ₂	He	Ar
Air [5-6]	21.0 %	79.0 %	0 %	0 %
O ₂ /N ₂ /He	21.2 %	39.6 %	39.2 %	0 %
O ₂ /He	21.7 %	0 %	78.3 %	0 %
O ₂ /Ar	21.6 %	0 %	0 %	78.4 %

Compositions of diluents used in this study in molar fraction

Diluent	Laminar burning velocity (cm/s)	Adiabatic flame temperature (K)
Air [5-6]	30	2221
O ₂ /N ₂ /He	61	2367
O ₂ /He	119	2541
O ₂ /Ar	77	2537
Xe	56	2513

Laminar burning velocity and adiabatic flame temperature of a stoichiometric mixture CH₄/diluent

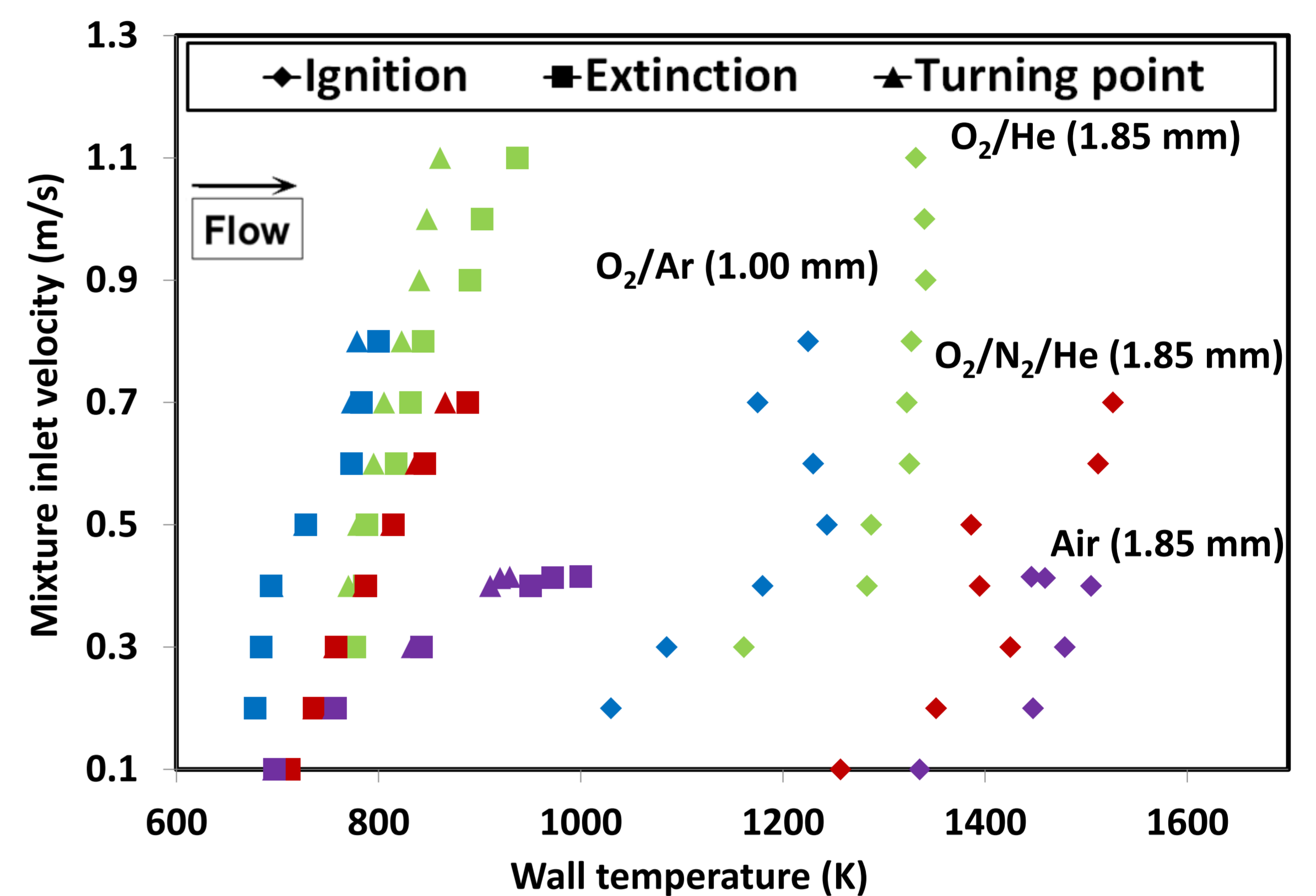

Diluent influence on characteristic experimental FREI points position evolution with the inlet mixture velocity

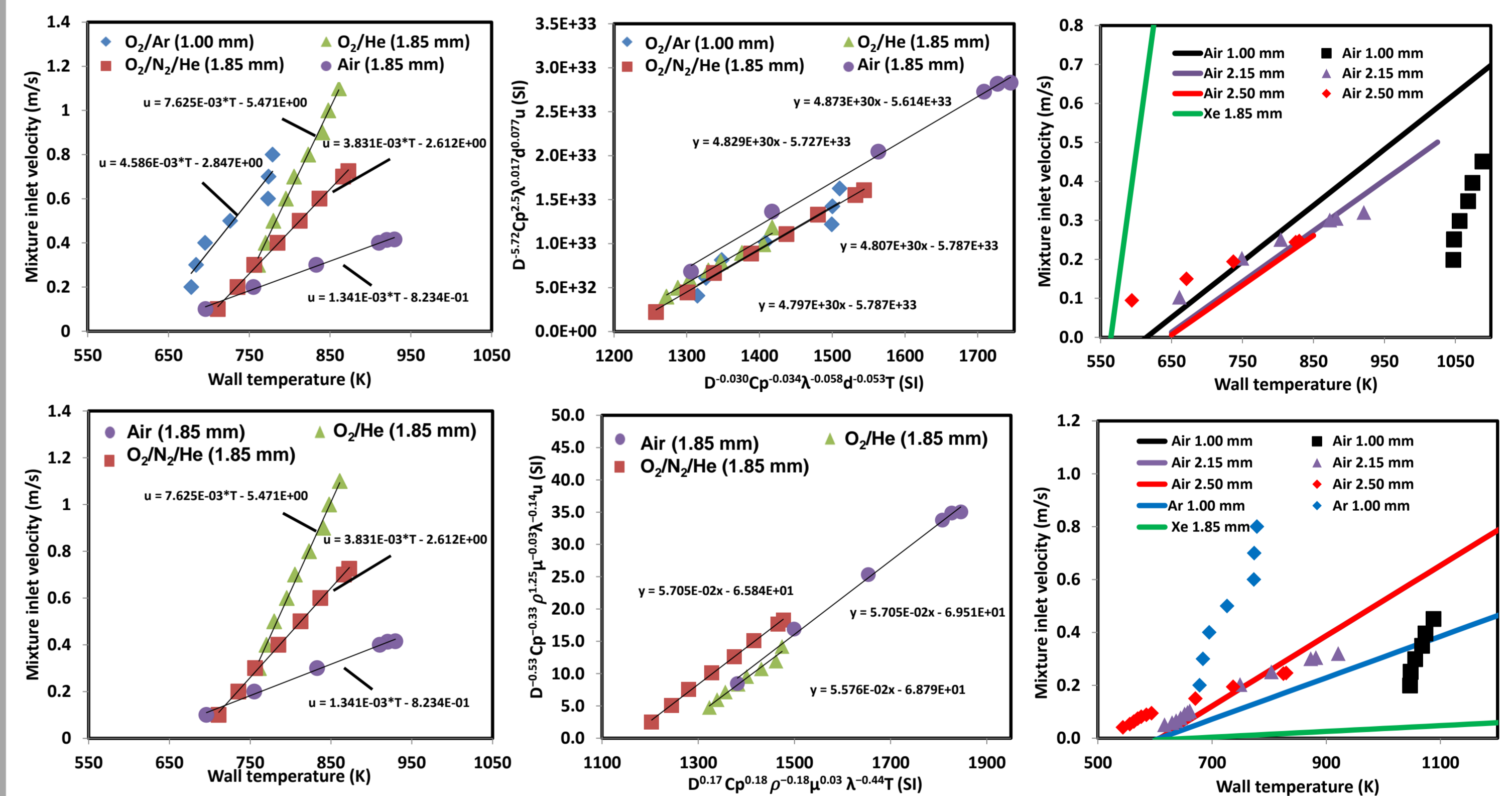
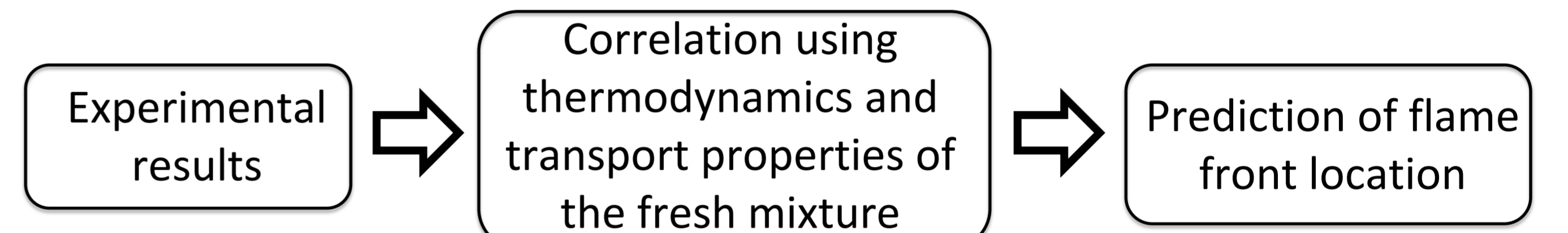

Temperature location of stoichiometric CH₄ maximum upstream location in FREI as a function of mixture inlet mean velocities for different diluents

Maximum upstream modified temperature location plotted as a function of the modified inlet mixture velocity

Comparison between the predicted position (solid line) with experimental results (dashed lines) for different diluent and inner diameters of the reactor

Diluent	Thermal conductivity (10 ⁻² W.m ⁻¹ .K ⁻¹)	Specific heat capacity (J.kg ⁻¹ .K ⁻¹)	Dynamic viscosity (10 ⁻⁵ Pa.s)	Density (kg.m ⁻³)	CH ₄ Mass diffusivity (10 ⁻⁵ m ² .s ⁻¹)
Air [5-6]	2.65	1075	2.18	1.12	2.34
O ₂ /N ₂ /He	5.48	1401	2.41	0.78	3.11
O ₂ /He	9.08	2240	2.80	0.43	4.54
O ₂ /Ar	2.03	661	2.70	1.47	2.32
Xe	0.97	235	2.40	4.12	1.76

CH₄/diluent mixture thermodynamics and transport properties at 300 K

5. Conclusions

- Difference between turning point and extinction point increases with the inlet mixture velocity
- A new method is used to establish a correlation between turning point and its location
- Mass diffusivity of the CH₄ and thermal conductivity seems to play a significant role
- There no simple relations between fluid properties and FREI behavior

Acknowledgements

Authors thank the Ministry of Research en Higher Education (MESRI) for a PhD grant. Support from the CAPRYSSES project (ANR- 11-LABX-006-01) funded by ANR through the PIA (Programme d'Investissement d'Avenir) is gratefully acknowledged.

[1] A. C. Fernandez-Pello, "Micropower generation using combustion: Issues and approaches," *Proc. Combust. Inst.*, vol. 29, no. 1, pp. 883-899, (2002)
 [2] K. H. Lee and O. C. Kwon, "Studies on a heat-recirculating microemitter for a micro thermophotovoltaic system," *Combust. Flame.*, vol. 153, no. 1, pp. 161-172, (2008).
 [3] P. Galie, B. Xu, and Y. Ju, "Kinetic Enhancement of Mesoscale Combustion by Using a Novel Nested Doll Combustor", *45th AIAA aerospace sciences meeting and exhibit*, (2007).
 [4] T. A. Wierzbicki, I. C. Lee, and A. K. Gupta, "Rh assisted catalytic oxidation of jet fuel surrogates in a meso-scale combustor," *Appl. Energy*, vol. 145, pp. 1-7, (2015).
 [5] A. Di Stazio, C. Chauveau, G. Dayma, and P. Dagaut, "Oscillating flames in micro-combustion", *Combust. Flame*, vol. 167, pp 392-394, (2016).
 [6] A. Di Stazio, "Caractérisation expérimentale de la dynamique de la combustion à micro-échelle", Thesis, Orléans, (2016).