



**HAL**  
open science

## Some METAFONT Techniques

Yannis Haralambous

► **To cite this version:**

| Yannis Haralambous. Some METAFONT Techniques. Tugboat, 1995, 16 (1), pp.46-53. hal-02101582

**HAL Id: hal-02101582**

**<https://hal.science/hal-02101582>**

Submitted on 23 Apr 2019

**HAL** is a multi-disciplinary open access archive for the deposit and dissemination of scientific research documents, whether they are published or not. The documents may come from teaching and research institutions in France or abroad, or from public or private research centers.

L'archive ouverte pluridisciplinaire **HAL**, est destinée au dépôt et à la diffusion de documents scientifiques de niveau recherche, publiés ou non, émanant des établissements d'enseignement et de recherche français ou étrangers, des laboratoires publics ou privés.

## Some METAFONT Techniques

Yannis Haralambous

### Abstract

This paper presents a few ideas on how to solve certain geometrical problems arising very often in character design, not directly solvable by METAFONT's `plain` macros. The first part of the paper presents two geometrical problems: the “*k problem*” and the “*x problem*”, their solutions using dichotomy, and a different solution using path intersections. The latter was proposed earlier on the net by the author; although geometrically correct, it does *not* work in real-world METAFONT practice: a nice example of METAFONT code . . . to avoid.

The second part of the paper presents two simple macros for drawing “loose” Bézier curves; in a sense, the opposite of the `tension` operator. Finally, the third part solves a problem stated by Alan Hoenig: how to extract text and data from a METAFONT run, without using the log file. This is done in a straightforward manner by running a Flex-generated preprocessor over the GF file: the Flex code for this utility is given in appendix B.

— \* —

## 1 Two geometrical problems, solved by iterated calculations

### 1.1 Description

Suppose you want to design a character ‘K’, as in the left part of fig. 1. The character should fit inside a box of width  $w$  and height  $h$ , and should consist of three strokes: the vertical stroke  $z_0 - - z_{0'}$ , and the two oblique strokes  $z_1 - - z_2$  and  $z_{1'} - - z_{2'}$ . Only constraint: the point  $z_{1l} = z_{1'r}$  should be fixed (for example, its coordinates can be  $(0, \frac{h}{2})$ ). So, here is the problem:

*Find a stroke  $z_1 - - z_2$  with fixed  $z_{1l}, y_{2l}, x_{2r}$ .*

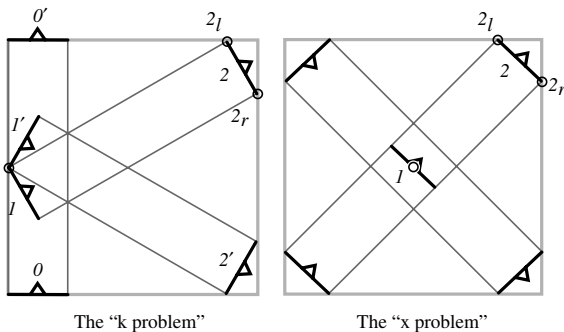

Figure 1: The two problems.

This problem is not trivial, because METAFONT cannot compute pen positions without knowing in

advance the angle of the pen (this stands both for defining a new pen with command `pickup pen` and for defining a simulated pen with command `penpos`). Because it arises when designing the letter ‘K’, we will call this problem the “*k problem*”.

The next problem is encountered when designing an ‘X’, as in the right part of fig. 1. Suppose you want to draw this letter. Once again it should fit inside the box, and should consist of two strokes. To keep the same notation as in the previous case, we have only given names to the pen positions concerning the upper right part of the letter. In this case the constraints are:  $z_1$  is fixed (and not  $z_{1l}$  as in the previous case), as well as  $y_{2l}$  and  $x_{2r}$ . Here again is the problem which we call the “*x problem*”:

*Find a stroke  $z_1 - - z_2$  with fixed  $z_1, y_{2l}, x_{2r}$ .*

Well understood, in both cases the direction of the stroke must be perpendicular to the angle of the pen: all strokes must keep the same width.

### 1.2 The solutions (which work)

Let’s start with the “*k problem*”. In fig. 2, the reader has a closer look at the situation. Point  $A$  is fixed, point  $B$  must lie on a fixed horizontal line  $H$ , and  $C$  on a fixed vertical line  $V$ . The angle  $\widehat{ABC}$  must stay orthogonal. Also the length  $\overline{BC}$  of the vector  $BC$  is fixed. METAFONT cannot compute the angle  $\phi$  directly, so that it fits to these constraints. But once we have chosen a point  $B'$ , METAFONT can calculate the corresponding  $C'$  so that  $AB' \perp B'C'$  and  $\overline{B'C'} = \overline{BC}$ .

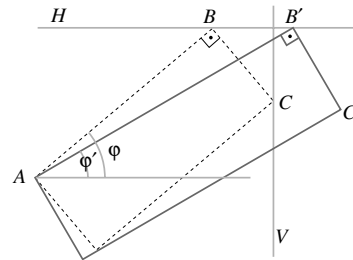

Figure 2: A closer look at the “*k problem*”.

So let’s choose a random point  $B' \in H$ , and find the corresponding  $C'$ . If  $C'$  lies on the right of  $V$  then we know that we should move  $B'$  more to the left, if  $C'$  lies on the left of  $V$  then  $B'$  should be moved more to the right. We will modify the position of  $B'$  by a certain step and start again. This procedure will be iterated until we get close enough to  $V$ . The step will be halved every time: because of the well-known equality  $\sum_{i \geq 1} \frac{1}{2^i} = 1$  we are sure that this process of iterations will converge to the

correct result. One may argue that the result will always be approximate; this is true in mathematics but a useless remark in computer calculations, since all values are approximate anyway. Once we have a sufficient precision we stop; the sufficient precision

depends on the implementation and the resolution of our character. This process is called *dichotomy* (from  $\delta\iota\chi\alpha$  = in two pieces, and  $\tau\acute{\epsilon}\mu\nu\omega$  = to cut), and is usually one of the first exercises in most programming languages. The code is shown below.

```

def solve_k_problem(suffix $, $$, $$$)(expr pen_width, first_try) =
pair z_zero; z_zero = z_$;
numeric x_one, y_one, x_two;
y_one = y_$$; x_one = first_try; x_two = x_$$$;
numeric theta, n; n := 1;
forever:
  clearxy; z_$ = z_zero; z_$$ = (x_one, y_one);
  theta := angle(z_$$ - z_$); pos_$$1(pen_width, theta - 90);
  if y_$ > y_$$:
    z_$$1r
  else:
    z_$$1l
  fi = z_$$;
  x_one := x_one
  if x_$$1r > x_two: -
  else: +
  fi abs(first_try - x_$)/(2 ** n);
  exitif((abs(x_$$1r - x_two) < 0.1) or (n > 13)); n := n + 1;
endfor
pos_$$$($width, theta - 90); z_$$$r = z_$$1r;
enddef;

```

This procedure expects that you feed it with: (a) the suffixes of points  $z_{1l}, z_{2l}$  and  $z_{2r}$ , (b) the width of the pen, (c) a hint on the first choice for  $x_{2l}$ . It usually works fine when your hint is simply the  $x$ -coordinate of  $z_{2r}$ . Theoretically it can go wrong if the  $x$ -projection of  $z_{1l} - z_{1r}$  is bigger than the first step of the iteration process. But this can hardly ever happen.

The iteration is stopped either (a) when the distance of  $z_{2r}$  to  $V$  is less than a tenth of a pixel, or (b) if  $n = 14$ , because the next step would produce a denominator  $2^{15} = 32,768$ , which is too big for (usual) METAFONT. Experience shows that with 8 steps one is usually done — again, all depends on the resolution.

Let's consider the second problem now. As the reader can see in fig. 3, only the position of point  $A$  differs. Nevertheless, this makes a big difference for METAFONT: in the previous problem, once we had chosen  $B'$  we could immediately calculate the position of  $C'$ . This is not the case here: all we know is that if  $D'$  is the middle of  $B'C'$ , then  $AD' \perp B'C'$ . So we need a different technique already to calculate the location of  $C'$  for each step of the iterating process. This will be done again by iteration.

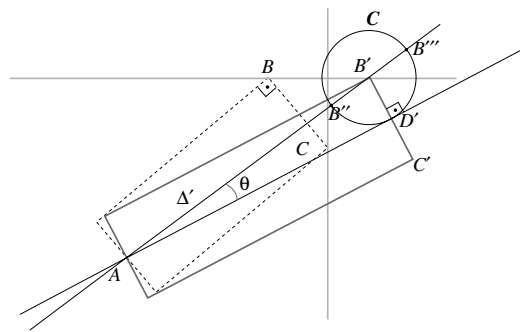
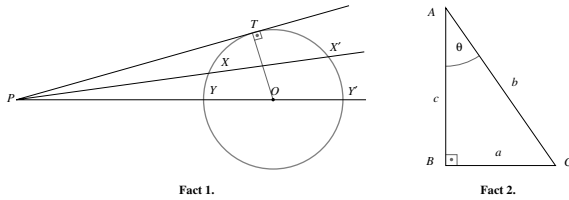

Figure 3: A closer look to the “ $x$  problem”.

But first let's consider two geometrical facts which we are going to use.

**Fact 1.** Let  $C$  be a circle, centered at  $O$ , and  $P$  a point outside the circle. For every line  $\Delta$ , going through  $P$  and intersecting the circle at points  $X$  and  $X'$ , the product of lengths  $\overline{PX} \cdot \overline{PX'}$  is constant. In particular, if  $PT$  is a tangent to the circle going through  $P$ , then  $\overline{PT}^2 = \overline{PX} \cdot \overline{PX'}$ .

As the reader can see on fig. 4, it follows from the previous fact that if  $\Delta'$  is the line going through  $P$  and  $O$ , and intersecting the circle at  $Y$  and  $Y'$ , then  $\overline{PT} = \sqrt{\overline{PY} \cdot \overline{PY'}}$ .



**Figure 4:** Two facts from elementary Euclidean geometry.

The second fact is even more trivial:

**Fact 2.** Let  $ABC$  be an orthogonal triangle; the right angle shall be  $\widehat{ABC}$ ; let's call  $\widehat{CAB} = \theta$ , and  $a, b, c$  the lengths of faces opposite to points  $A, B, C$ . Then  $\theta = \arccos(\frac{c}{b})$ .

Let's return to our problem (see fig. 3).  $D'$  is on a circle  $\mathcal{C}$  centered at  $B'$ , of radius  $\frac{1}{2}\overline{BC}$  (half the width of the stroke, since  $\overline{B'D'} = \overline{D'C'}$ ). Also we know that  $AD' \perp B'C' \Rightarrow AD' \perp B'C' \Rightarrow AD'$  is tangent to circle  $\mathcal{C}$ . Let's draw the line  $\Delta$ , going through points  $A$  and  $B'$ . It will intersect  $\mathcal{C}$  at points  $B''$  and  $B'''$ . From **Fact 1** we know that  $\overline{AB''} \cdot \overline{AB'''} = \overline{AD'}^2$ . So we do not yet have  $D'$  itself, but the length of  $AD'$ .

Let's apply now **Fact 2** to the orthogonal triangle  $AD'B'$ . We obtain:  $\theta = \arccos(\overline{AD'}/\overline{AB'})$ . Once we have the angle and the length of  $AD'$ , we have point  $D'$ , and we are done for this step of the iterating process. The remainder of the solution is similar to that of the “ $k$  problem” : we are moving  $B'$  around until  $C'$  is close enough to line  $V$ .

Let's try to implement this solution in METAFONT. **Fact 1** can be implemented easily: of course one should avoid multiplying two lengths (because of a possible overflow error), but there should be no problem if we take the square root of each length first (for purists: lengths are always positive!). So instead of  $\overline{AD'}^2 = \overline{AB''} \cdot \overline{AB'''}$  we will formulate the equation as  $\overline{AD'} = \sqrt{\overline{AB''}} \cdot \sqrt{\overline{AB'''}}$ .

**Fact 2** is a little harder to implement. As a matter of fact, the reader may have noticed that although METAFONT provides exponential and logarithmic functions, there are no inverse trigonometric functions. What should be done? Unfortunately, METAFONT offers no complex calculus so that formulas such as  $\cos(x) = \frac{1}{2}(e^{xi} + e^{-xi})$  could be applied; power series cannot be used either because our candidates for angles are not necessarily in a neighborhood of 0; using an external program to make this calculation would be highly unorthodox. Let's use dichotomy once again!

Here is the code for a *arccosd* procedure in METAFONT:

```
def arccosd(expr ttt) =
if ttt > 1:
  message("error: arccosd argument > 1!!???"); stop;
else: numeric a_;
  numeric test, nnn, prev; test := 45; nnn := 1;
  prev := cosd(test);
  forever:
    nnn := nnn + 1;
    if cosd(test) < ttt:
      test := test - (90/(2 ** nnn))
    else:
      test := test + (90/(2 ** nnn))
    fi;
  exitif((abs(test - prev) < 0.01) or (nnn > 14));
  prev := test;
endfor
fi a_ := test; enddef;
```

The above procedure requires as argument a number  $ttt \in ]0, 1[$ . It stores the result in the numeric variable  $a_$ . The first try is always  $\frac{\pi}{4}$ . Since we want to solve a specific problem (the “ $x$  prob-

lem”), one must consider *arccosd* for only the first quadrant: solutions will always be in the range  $]0, \frac{\pi}{2}[$ . One can easily generalize the code to work in different ranges. In particular it would be nice to

modify the code to allow us getting results in the complex domain for  $ttt \in ]-\infty, 0[ \cup ]1, \infty[$  but the author can hardly see the utility of these for METAFONT. . .

Let us now have a look at the solution of the “*x problem*”, as it is shown below.

A word of explanation concerning the pen position  $z$  is perhaps necessary. This is a quick way to

obtain the intersection of line  $\Delta'$  (fig. 3) and circle  $C$ : the pen  $z$  lies on  $\Delta'$  and points  $z_r$  and  $z_l$  are at the right distance from point  $z$ . As we shall see in the following section this method yields results that are accurate enough for our purpose.

The same idea has been used to explicitly define point  $z$ : by taking pen position  $z$ , the right edge of the pen is on point  $D'$  of the figure.

```

def solve_x_problem(suffix $, $$, $$$)(expr pen_width, first_try) =
pair z_zero; z_zero = z_$;
numeric x_one, y_one, x_two;
y_one = y_$$; x_one = first_try; x_two = x_$$$;
numeric theta, n, phi, tangent_length; n := 1;
forever:
  clearxy; z_$ = z_zero; z_$$ = (x_one, y_one);
  theta := angle(z_$$ - z_$);
  pos_$$ (pen_width, theta);
  tangent_length := sqrt(length(z_$$l - z_$$)) * sqrt(length(z_$$r - z_$$));
  arccosd(tangent_length / length(z_$$ - z_$$)); phi := theta - a_;
  pos_$(2*tangent_length, phi); z_$.1r = z_r + (z_r - z_$$); z_$.1l = z_$$;
  x_one := x_one
  if x_$.1r > x_two: -
  else: +
  fi
  abs(first_try - x_$(2**n));
  exitif((abs(x_$.1r - x_two) < 0.1) or (n > 13)); n := n + 1;
endfor
z_$.1l = z_$.1l; z_$.1r = z_$.1r; z_$$ = 0.5[z_$.1l, z_$.1r];
enddef;

```

The entries for this procedure are the same as for *solve\_k\_problem*. Again the problem is solved in the specific case of the right and upper part of letter ‘X’; for the other possible cases, one should either change the code (straightforward but tedious), or use symmetry arguments.

### 1.3 A solution which doesn’t work, and why

The author must confess that the first time he had to solve the “*x problem*” was during a METAFONT tutorial at the Royal Holloway College (UK) [this shows how badly the tutorial was prepared. . . *mea culpa*]. On the spot I could find no solution, yet on my way back across the Channel on the ship I found the code shown below. I am convinced that people taking the tunnel nowadays write better METAFONT code!

Let  $C$  be a circle, centered at  $B'$  and of radius  $\frac{1}{2}B'C$ , as in fig. 5. The intersection of  $\Delta'$  and  $C$  gives us points  $B''$  and  $B'''$ . From **Fact 1**, we obtain the length of  $AD'$ . Now,  $D'$  is at a known distance from

$A$ , and upon circle  $C$ . Take a circle  $C'$ , centered at point  $A$  and of radius  $\overline{AD'}$ . The (right) intersection of circles  $C$  and  $C'$  is the desired point  $D'$ .

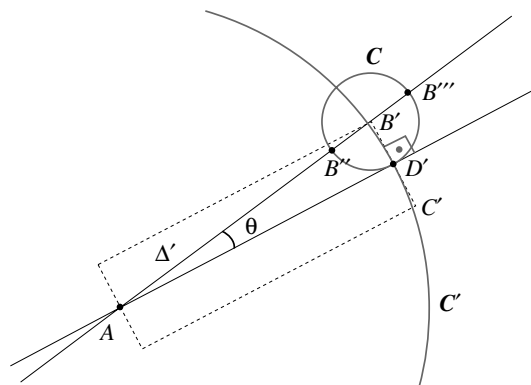

**Figure 5:** A solution of the “*x problem*” which doesn’t work in METAFONT.

This method is mathematically correct — but if you try it out you will get extremely bad results.

The problem is that when we define a **path**, METAFONT does not consider it as an abstract curve, but as a set of pixels. When we ask for the intersection of two paths, we obtain the *pixel* which is the closest to the (theoretical) intersection of the paths. In the solution sketched above, the intersection of the two circles is taken as an abstract point, and its coordinates are used for calculations. The result is of course completely deformed.

## 2 Loosening Bézier curves

Bézier curves are quite beautiful, and METAFONT allows us to obtain them even out of only *partial* information: for example, one can ask for “a curve leaving point A following a vertical direction and arriving at point B following a horizontal direction”. There is an infinite number of Bézier curves with exactly these features; METAFONT will choose one of them, out of hard-wired criteria. Most of the time, METAFONT’s choice is exactly what you need; but it may also happen that you want to keep some other curve in the same set. There are two operators allowing us to do this:

```
def npush(expr p, coef) =
  hide(pair firstpt, firstcpt, secondcpt, secondcpt; firstcpt =
  postcontrol 0 of p; secondcpt = precontrol 1 of p; firstpt = point 0 of p; secondcpt
  = point 1 of p; pair intersectpt, newfirstcpt, newsecondcpt;
  intersectpt - firstpt = whatever * (firstcpt - firstpt);
  intersectpt - secondcpt = whatever * (secondcpt - secondcpt);
  newfirstcpt = coef[firstcpt, intersectpt]; newsecondcpt = coef[secondcpt, intersectpt]; )
  firstpt .. controls newfirstcpt and newsecondcpt .. secondcpt
enddef;
```

The macro *npush* takes two arguments: the path we want to loosen, and a numerical coefficient. For value 0 of this coefficient, the path remains unchanged. What happens when we increase this value? Let’s consider the intersection point of the two Bézier tangents (the tangent at curve beginning and end). We know that control points always lie on these two tangents. For values between 0 and 1 of the coefficient, the control points travel between their original positions and the intersection point. For value 1 both control points are identified with

```
def mpush(expr p, lcoef, rcoef) =
  hide(pair firstpt, firstcpt, secondcpt, secondcpt; firstcpt =
  postcontrol 0 of p; secondcpt = precontrol 1 of p; firstpt = point 0 of p; secondcpt
  = point 1 of p; pair newfirstcpt, newsecondcpt;
  newfirstcpt - firstpt = lcoef * (firstcpt - firstpt);
  newsecondcpt - secondcpt = rcoef * (secondcpt - secondcpt); )
  firstpt .. controls newfirstcpt and newsecondcpt .. secondcpt
enddef;
```

1. **tension**, which allows us to get tense curves;
2. **controls**, by which we can explicitly determine the control points of our Bézier curve.

One can use **tension** quite intuitively: for a value of 1, the path remains unchanged; for higher values the path gets more and more tense. On the other hand, the operator **controls** gives us absolute control of the curve—but this is certainly not intuitive; maybe Leonardo da Vinci was smart enough to be able to guess the control point coordinates of Joconda’s smile, but the rest of us would probably be unable to do it.

So it happened that the author often needed “loose” Bézier curves, and was unable to obtain them; unfortunately, **tension** doesn’t work with values less than .75. (In fact, the METAFONTbook does not mention what the lower bound of the tension parameter is; however, repeated tries by the author have shown that the value .75 still works, while  $.75 - \epsilon$  produces an error message.) With the following code, one can get arbitrarily loose Bézier curves:

the intersection point. For values higher than 1 they continue their travel outside of the Bézier triangle.

In Appendix A the reader can see the effects of the *npush* macro applied uniformly to all paths of a circle, with values of the coefficient going from  $-5$  to  $5$ .

As the reader has surely already noticed, this macro doesn’t work when the tangents are parallel (because there is no Bézier triangle in that case). A second macro, with a slightly different approach covers all possible cases:

This macro has three arguments: the path which we will modify, and two numerical coefficients, corresponding to the transformation at curve beginning and at curve end. This time we multiply the distance of the first control point from curve beginning by the first coefficient, and that of the second control point from curve end by the second coefficient. Hence, in this case, value 1 for both coefficients will leave the path unchanged. For values higher than 1 the path will “swell”, while for values tending to 0 it will become more and more tense.

These two macros may not be as reliable as primitive METAFONT operators, but they produce easily predictable results and are suitable for fine-tuning of character parts.

### 3 Getting text and numeric data out of a font

In his extremely interesting paper on communication between T<sub>E</sub>X and METAFONT [1], Alan Hoenig states that “...*METAFONT's file handling abilities are greatly crippled when compared to T<sub>E</sub>X. Other than font pixel files, font metric files, and log files, METAFONT cannot write files.*...” To remedy that situation, we present GFtoTXT, a small utility for reading text (and any other information) out of GF files produced by METAFONT. As a matter of fact, METAFONT has a *special* command, just like T<sub>E</sub>X, but until now, no DVI driver was able to use it (as a possible use, one could very well imagine PostScript color instructions embedded in the GF files, taken over by the PK files and translated into real PostScript commands by the DVI driver).

GFtoTXT is written in Flex, a UNIX-originated lexical analyzer, under GNU copleft. Flex allows the generation of highly reliable C code out of sim-

```
special("#(CHAR C A\n (HEIGHT R " & decimal h & ")\n (WIDTH R " & decimal w & ")\n");
```

will produce

```
(CHAR C A
(HEIGHT R 99.99976)
(WIDTH R 129.99683)
```

```
special("#\X2665\X03a3\X0027\X0020\X1f00\X03b3\X03b1\X03c0\X1ff6\X2665");
```

### 4 Bottom line

The different METAFONT techniques presented in this paper are certainly not programmed in the most elegant way; the author needed them for specific purposes, and stopped testing and refining when-

ever the specific problem was solved. It is *not* the goal of this paper to provide the reader with powerful new tools, but rather to stimulate him/her in creating his/her own, and to go beyond the plain and cm base macros. In all three examples, the basic idea was very simple: iterate calculations until a

ple pattern matching, using regular expressions and states. The Flex code of GFtoTXT is very short; the reader can find it in Appendix B. To obtain an executable, (a) run this code through Flex, with the -8 option — Flex will produce a C file called `lex.yy.c` (or `LEX_YY.C` on Messy-DOS systems); (b) compile it using your favourite C compiler. The Flex code as well as executables can be found on `ftp.ens.fr`, in `pub/tex/yannis/gftotxt`.

How does it work? There is one convention which must be followed: every string which we want to extract from the METAFONT run must start with the character #. This precaution is necessary because METAFONT itself sends several strings to the GF file by using internal *special* commands.

These will be ignored by GFtoTXT. Hence, to obtain the string “Hello world!” in our output file (let’s call it `output.txt`), we will include the command

```
special("#Hello world!");
```

in the METAFONT code of our file (let’s call it `input.mf`). GFtoTXT reads from the standard input flow and writes to the standard output flow, so we only need to redirect these; here is the necessary command line:

```
GFtoTXT < input.mf > output.txt
```

GFtoTXT allows three additional conventions in METAFONT strings: (a) `\n` will produce a carriage return in the output file, and (b) `\x` followed by a two-digit (lowercase) hexadecimal number between 00 and ff will produce the corresponding 8-bit character in the output file, (c) `\X` followed by a four-digit (lowercase) hexadecimal number between 0000 and ffff will produce the corresponding 16-bit character in the output file. Convention (a) is useful for “formatting” the output file, for example

Convention (b) is useful for inserting 8-bit characters (or characters in the range “00–1f”) into the output file. Finally, convention (c) can be useful to those of us who use UNICODE encoding: wouldn’t it be nice to have METAFONT say to us  $\heartsuit\Sigma'$   $\acute{\alpha}\gamma\pi\omega\heartsuit$ ? the necessary code would be

ever the specific problem was solved. It is *not* the goal of this paper to provide the reader with powerful new tools, but rather to stimulate him/her in creating his/her own, and to go beyond the plain and cm base macros. In all three examples, the basic idea was very simple: iterate calculations until a

sufficiently precise approximation is obtained, modify a path by manipulating the control points in the background, read the GF file by something else than GFtoPK or GFtoDVI. By writing down and sharing such ideas we can make out of METAFONT an even friendlier and more productive font design tool. To discuss METAFONT relative issues, but also font design in general (and why PostScript and TrueType are less efficient than METAFONTs), join the METAFONT e-mail discussion list! The address of the list on the Internet is:

`metafont@ens.fr`

You can subscribe by sending the following subscription message to `listserv@ens.fr`:

### A Transforming a circle through *npush*

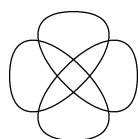

coef = -5

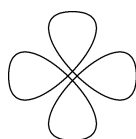

coef = -4

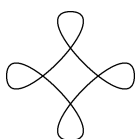

coef = -3

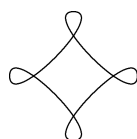

coef = -2.5

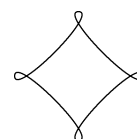

coef = -2

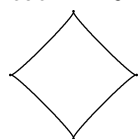

coef = -1.5

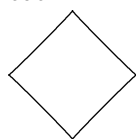

coef = -1.3

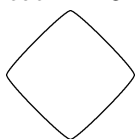

coef = -1

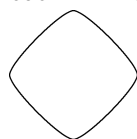

coef = -0.8

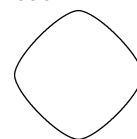

coef = -0.6

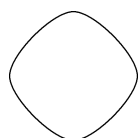

coef = -0.5

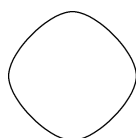

coef = -0.4

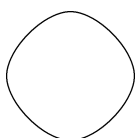

coef = -0.3

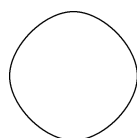

coef = -0.2

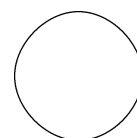

coef = -0.1

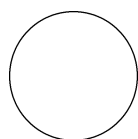

coef = 0

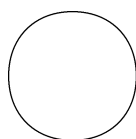

coef = 0.1

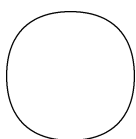

coef = 0.2

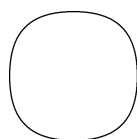

coef = 0.3

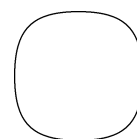

coef = 0.4

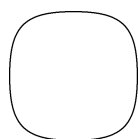

coef = 0.5

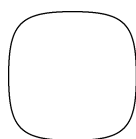

coef = 0.6

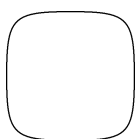

coef = 0.8

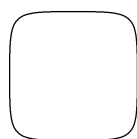

coef = 1

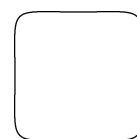

coef = 1.3

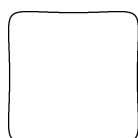

coef = 1.5

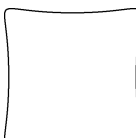

coef = 2

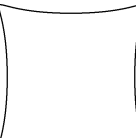

coef = 2.5

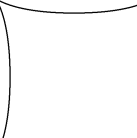

coef = 3

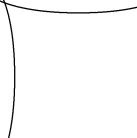

coef = 5

SUBSCRIBE METAFONT *Your name and institution*

### References

- [1] Hoenig, A. *When T<sub>E</sub>X and METAFONT talk: Typesetting on curved paths and other special effects*, pp. 549–553, *TUGboat* **12** (4), 1991

◇ Yannis Haralambous  
187, rue Nationale, 59800 Lille,  
France.  
Email: `haralambous@univ-lille1.fr`



**B The Flex code of GftoTXT**

```

%{
#define HEXA(A,B) (yytext[(A)]>='a'? yytext[(A)]-'a'+10 : \
  yytext[(A)]-'0')*16 + (yytext[(B)]>='a'? yytext[(B)]-'a'+10 : yytext[(B)]-'0')
long int length_special = 0L; int we_need_it = 0, pre_length = 0;
%}

%x READ_SPECIAL
%x READ_PRE

%%

([\x00-\x3F\x45\x46\x4A-\xEE\xF4\xF8-\xFF])|([\x40\x47]..)|([\x41\x48]..) ;
([\x42\x49]...)|(\x43.{24})|(\x44.....) ;

\xEF.# { BEGIN READ_SPECIAL; length_special = yytext[1] - 1L; we_need_it=1; }
\xEF. { BEGIN READ_SPECIAL; length_special = yytext[1]; we_need_it=0; }

\xF0..# { BEGIN READ_SPECIAL; length_special = (yytext[1] * 256L) + yytext[2] - 1L;
  we_need_it=1; }

\xF0.. { BEGIN READ_SPECIAL; length_special = (yytext[1] * 256L) + yytext[2];
  we_need_it=0; }

\xF1...# { BEGIN READ_SPECIAL; length_special = ((yytext[1] * 256L) +
  yytext[2]) * 256L + yytext[3] - 1L; we_need_it=1; }

\xF1... { BEGIN READ_SPECIAL; length_special = (((yytext[1] * 256L) + yytext[2])
  * 256L) + yytext[3]; we_need_it=0; }

\xF2...# { BEGIN READ_SPECIAL;
  length_special = (((((yytext[1] * 256L) + yytext[2]) * 256L) + yytext[3]) * 256L)
  + yytext[4] - 1L; we_need_it=1; }

\xF2... { BEGIN READ_SPECIAL;
  length_special = (((((yytext[1] * 256L) + yytext[2]) * 256L) + yytext[3]) * 256L)
  + yytext[4]; we_need_it=0; }

<READ_SPECIAL>. { length_special--; if (we_need_it==1) printf("%c",yytext[0]);
  if (length_special==0L) BEGIN 0; }

<READ_SPECIAL>\\x.. { length_special-=4;
  if (we_need_it==1) printf("%c",HEXA(2,3)); if (length_special==0L) BEGIN 0; }

<READ_SPECIAL>\\X.... { length_special-=6; if (we_need_it==1)
  printf("%c%c",HEXA(2,3),HEXA(4,5)); if (length_special==0L) BEGIN 0; }

<READ_SPECIAL>\\n { length_special-=2; if (we_need_it==1) printf("\\n");
  if (length_special==0L) BEGIN 0; }

(\xF3...)|(\xF5.{17})|(\xF6.{10}) ;

\xF7.. { pre_length = yytext[2]; BEGIN READ_PRE; }

<READ_PRE>. { pre_length--; if (pre_length == 0) BEGIN 0; }

.|\\n ;

%%

main()
{
  yylex();
}

```