

AGRO
CAMPUS
OUEST



Mathematical modelling of food digestion



STLOpen Days
19-21 March 2019



Steven LE FEUNTEUN – BN



Modelling is a complementary tool



IN VIVO

« Gold standard »,
mandatory to demonstrate
physiological effects



IN VITRO

To study the mechanisms,
predict *in vivo* outcomes,
screen food formulations...

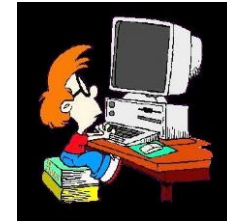

IN SILICO

Mathematical models to
understand, predict,
gather knowledge...

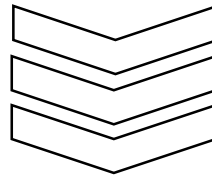

EVALUATE THE NUTRITIONAL PROPERTIES

**HYPOTHESES ON THE MECHANISMS
AND KEY FACTORS**

Iterative improvement



Modelling *in vitro* digestion of lipids

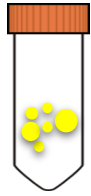

Results from static *in vitro* digestions of an emulsion (made of 2 oils)

UMR GMPA
UR BIA

% of hydrolyzed TAG

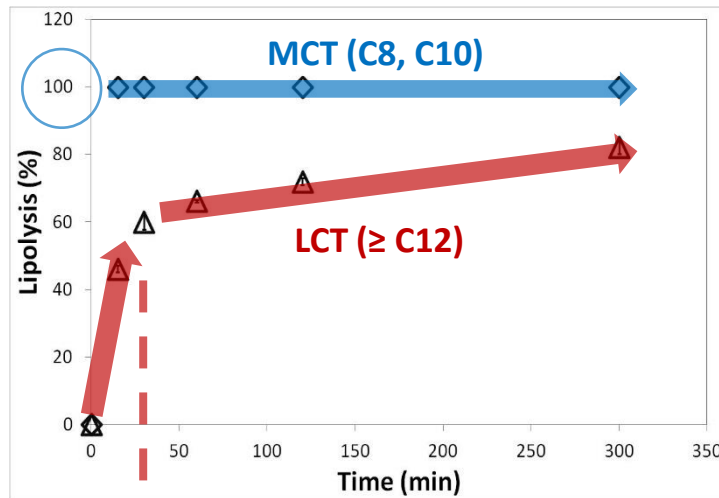

Droplet size of remaining droplets

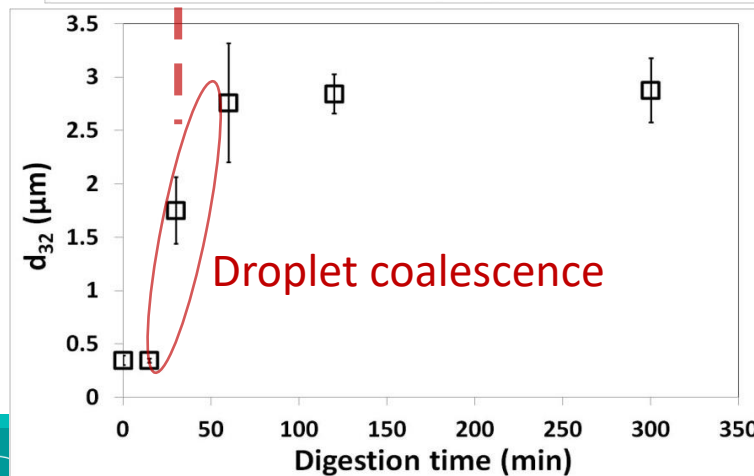

Does the slowdown is fully explained by the reduction of the interfacial area ?

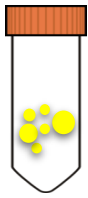

Modelling *in vitro* digestion of lipids

- ❖ Lipolysis rate is proportional to the interfacial area

$$\frac{dm_{TAG}(t)}{dt} = -k_h \cdot A(t)$$

- ❖ Droplets are spherical

$$A(t) = 6 \cdot \frac{V(t)}{d_{32}(t)}$$

- ❖ Resulting equation

$$\frac{dm_{TAG}(t)}{dt} = -k_h \cdot 6 \cdot \frac{m_{TAG}(t)}{\rho \cdot d_{32}(t)}$$

Linear interpolation between measured d_{32}

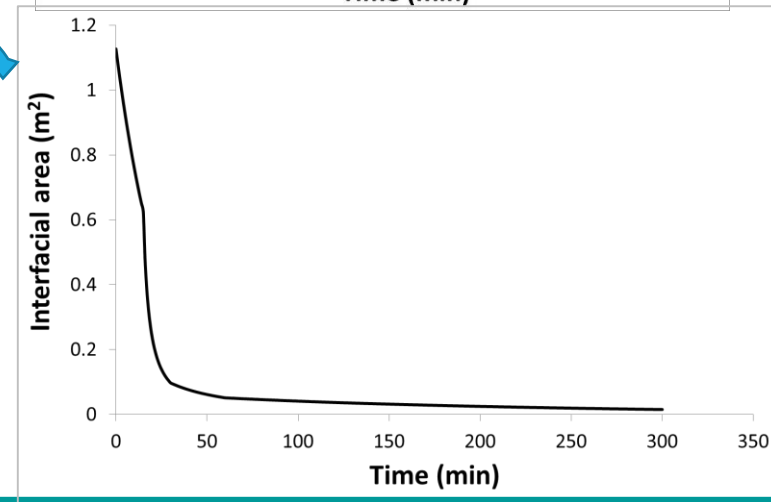
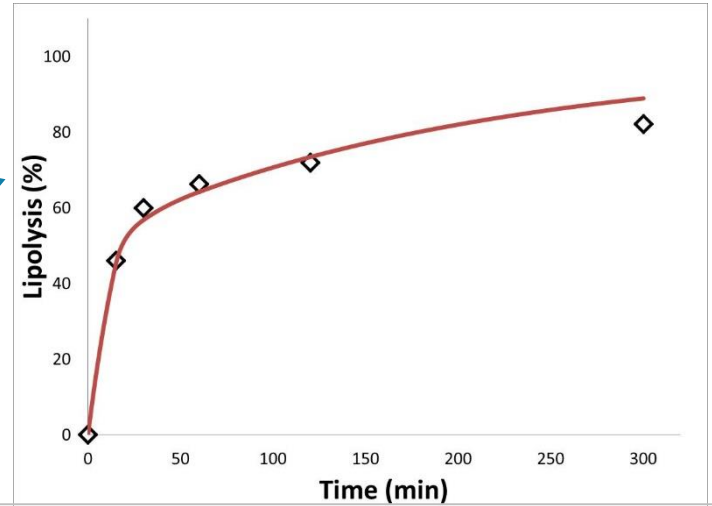

Emulsion destabilization was indeed the main cause for the slowdown

Modelling *in vitro* digestion of lipids

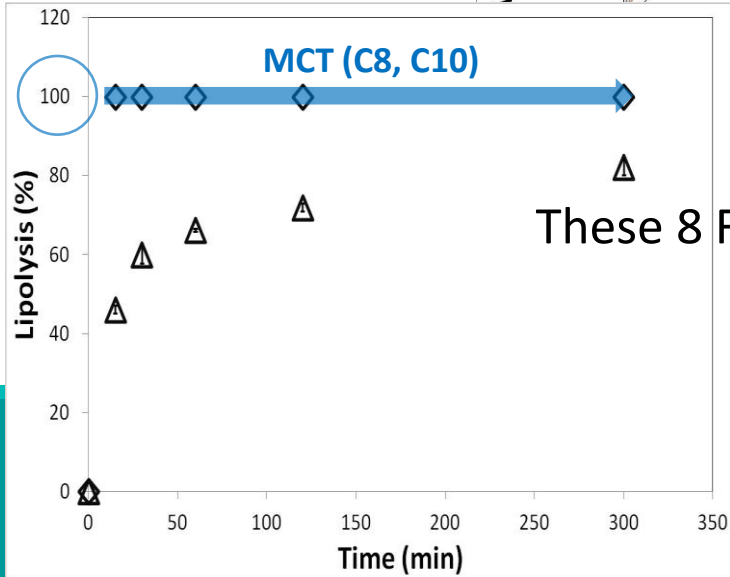
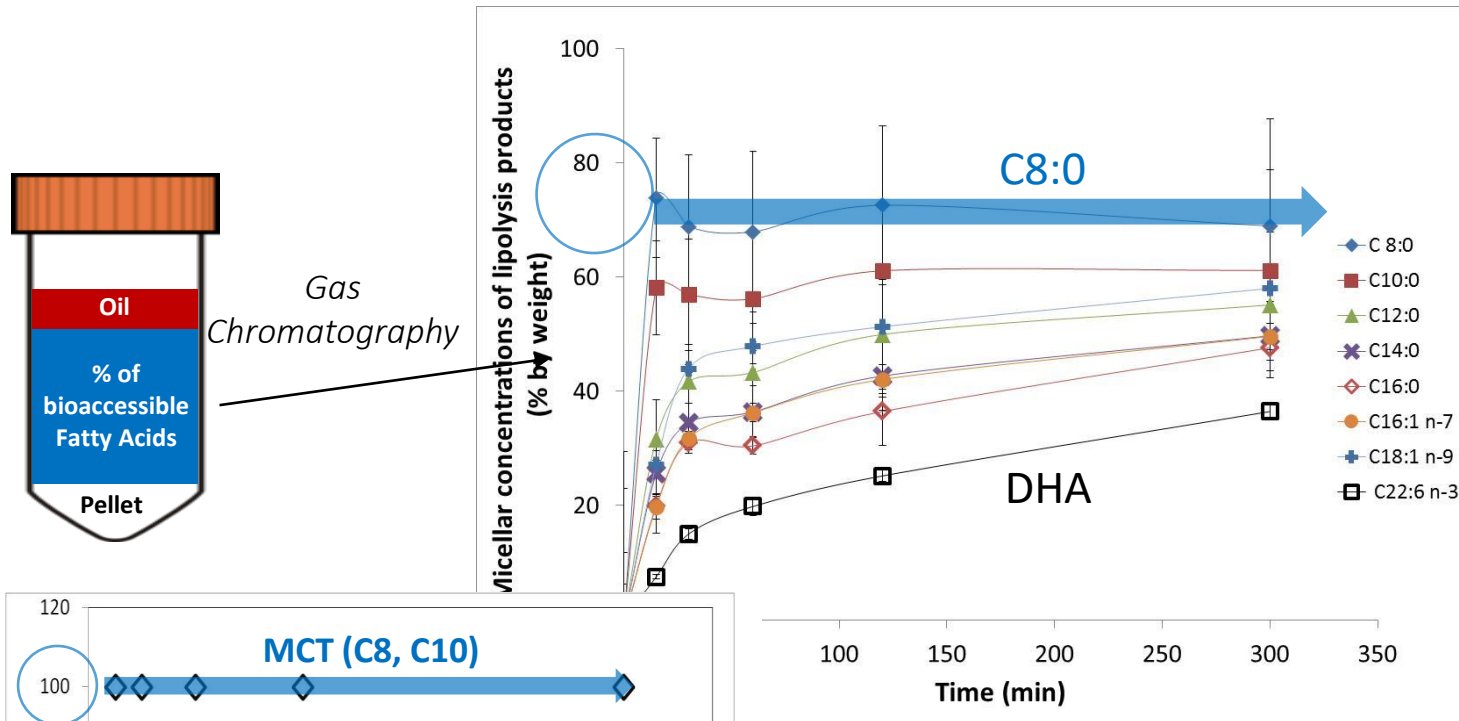

These 8 FA represent 95.6 wt% of all FA.
 Only part of lipolysis products are bioaccessible



Modelling *in vitro* digestion of lipids

- ❖ Lipolysis rate of a given FA_i is proportional to the interfacial area thereof

$$\frac{dm_{FA_i}^{lip}(t)}{dt} = -k_{FA_i} \cdot A_{FA_i}(t)$$

- ❖ The interfacial area occupied by FA_i at time t is proportional to its molar fraction

$$A_{FA_i}(t) = \frac{n_{FA_i}^{lip}(t)}{\sum_i n_{FA_i}^{lip}(t)} \cdot A_{TAG}(t)$$

- ❖ Only the fraction of FA_i transferred into the micellar phase is bioaccessible

$$\frac{dm_{FA_i}^{mic}}{dt} = -f_{FA_i}^{mic} \frac{dm_{FA_i}^{lip}}{dt}$$

Modelling *in vitro* digestion of lipids



% of bioaccessible
FA

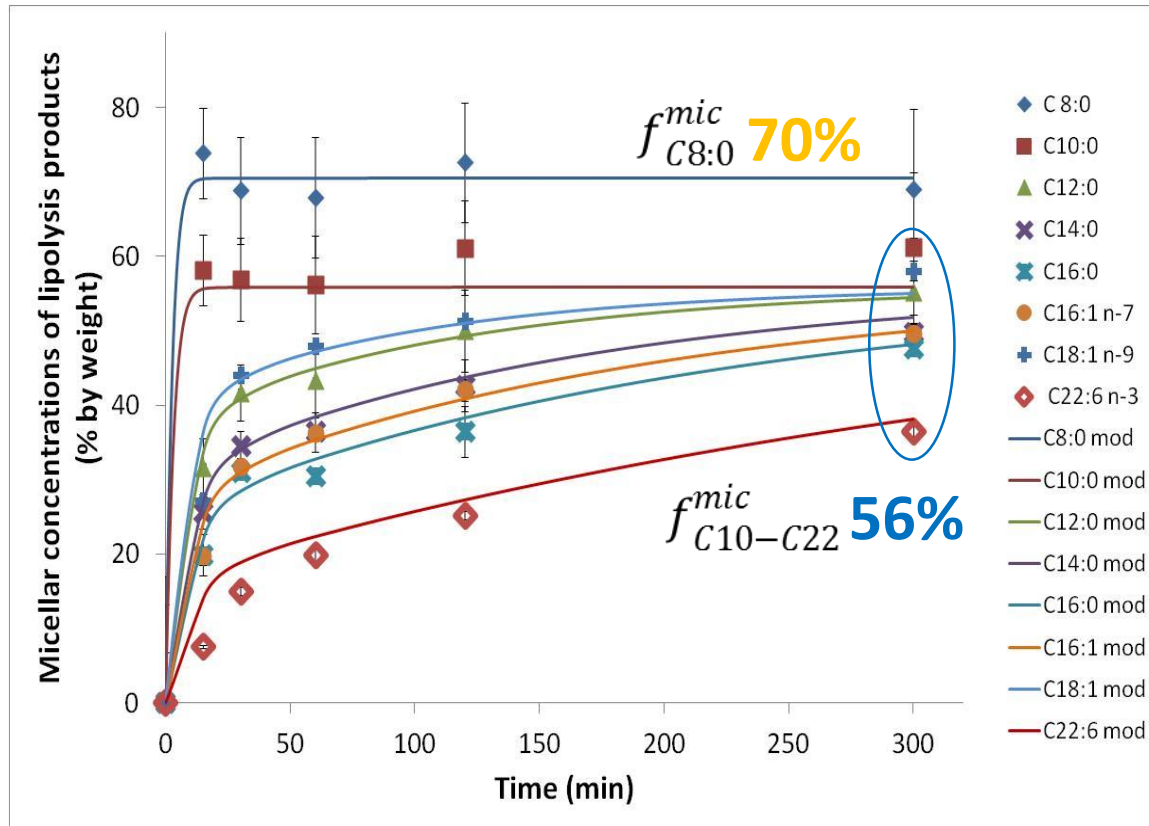

C10:0 to C22:6



C8:0



0%

55%

70%

100%

Models of transit and absorption

GI tract = a series of reactors (chemical engineering approach)

Observed and simulated transit in the GI tract

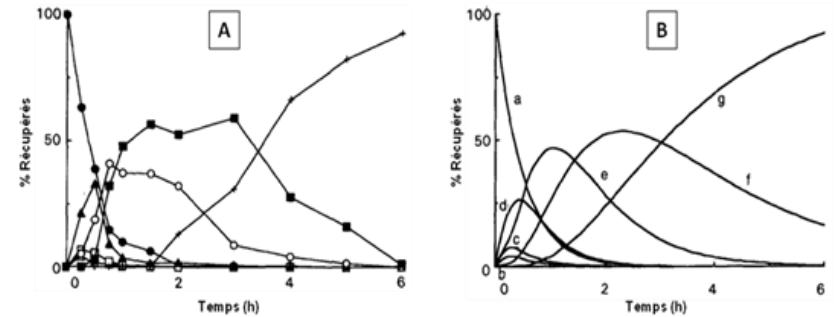
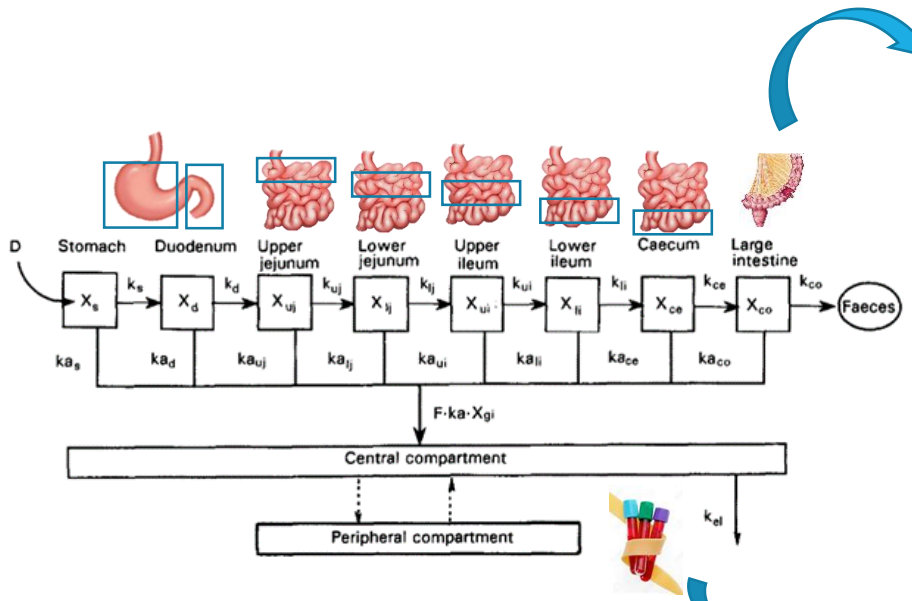

Observed and simulated concentration in blood

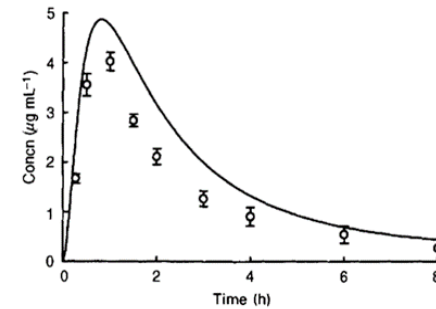

Modelling the digestion of dairy proteins



UR MaIAGE
UMR GMPA
UNH

6 matrices with ≠ structures



- Raw milk (skimmed)
- Heat Treated Milk
- Acid gel



- Acid gel + 2 min mixing
- Rennet gel of the raw milk
- Rennet gel of the HT milk

6 mini-pigs

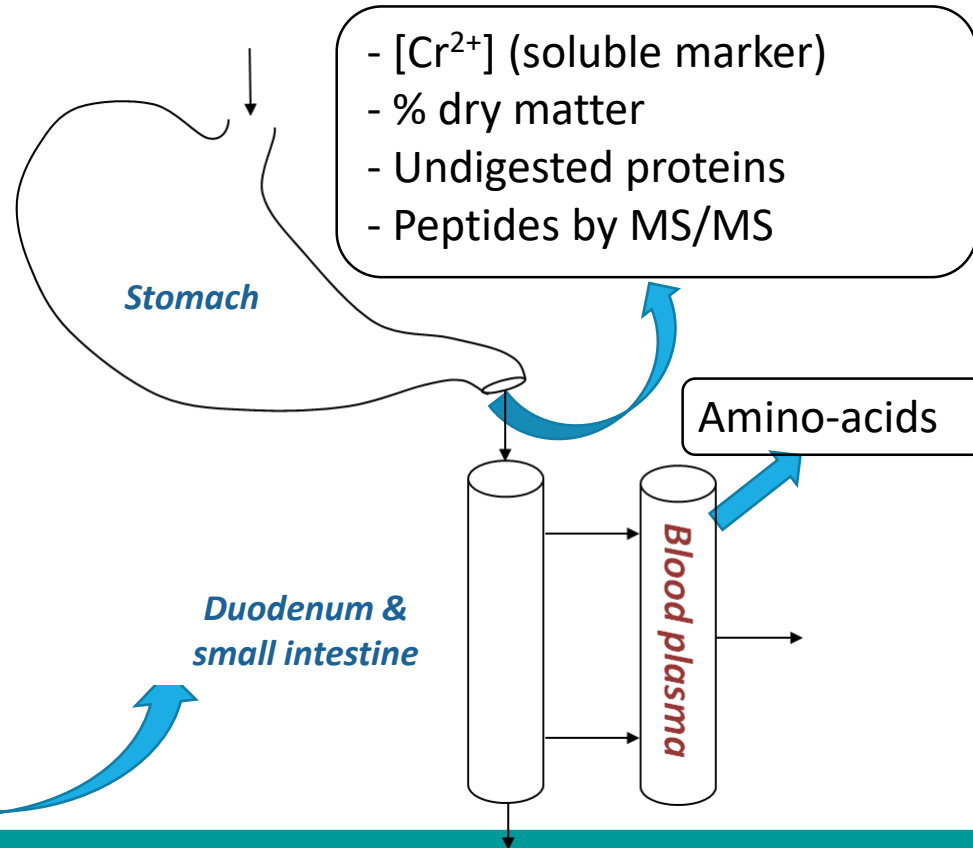

Examples of experimental results

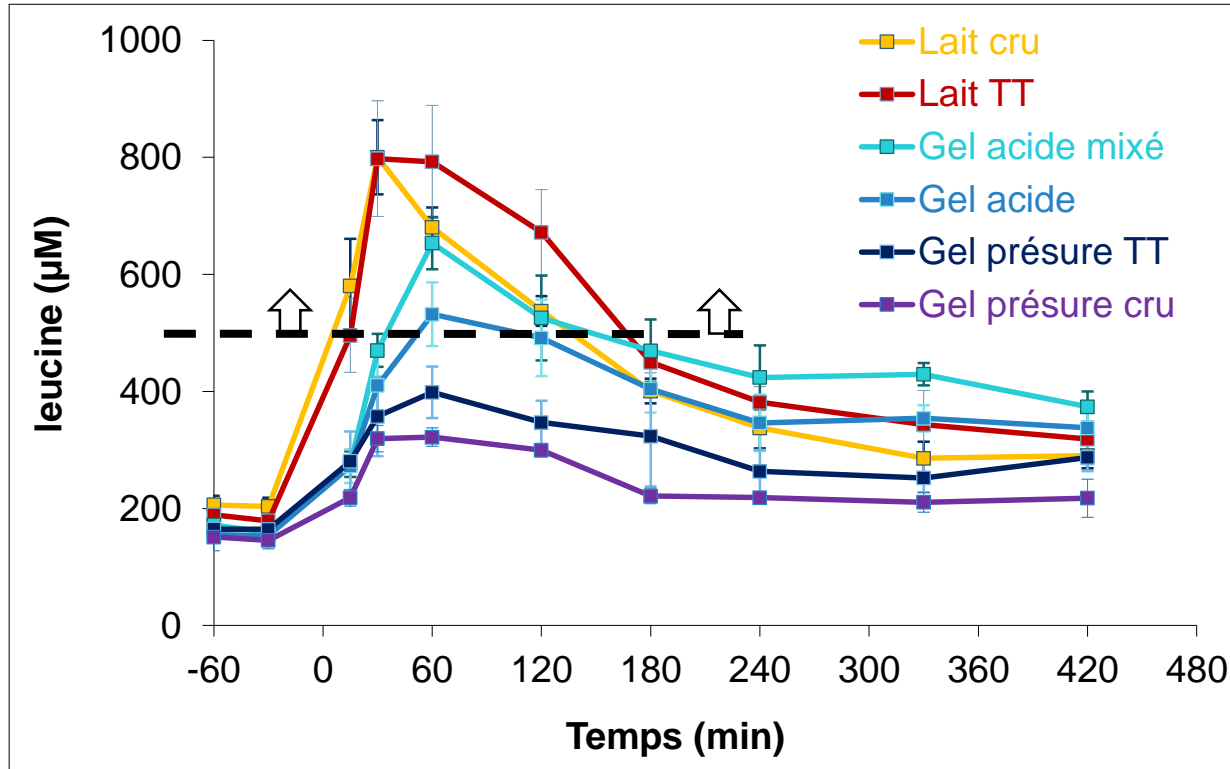

Above a threshold, which increases with age, muscular synthesis is stimulated

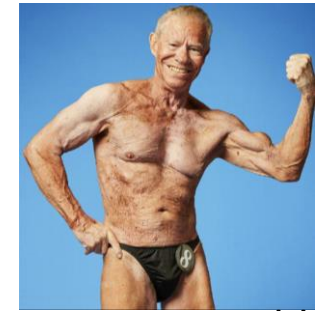

85 years-old

Modelling the digestion of dairy proteins

Contrasted behaviours within the stomach:

- Milks clot because of the decreasing pH
- Gels can undergo syneresis

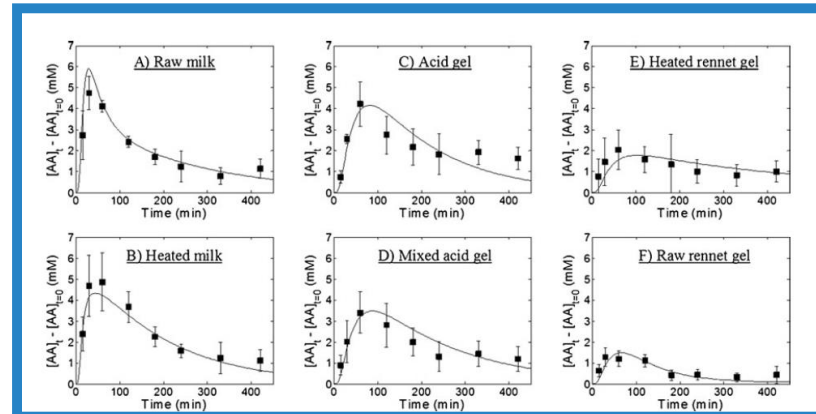
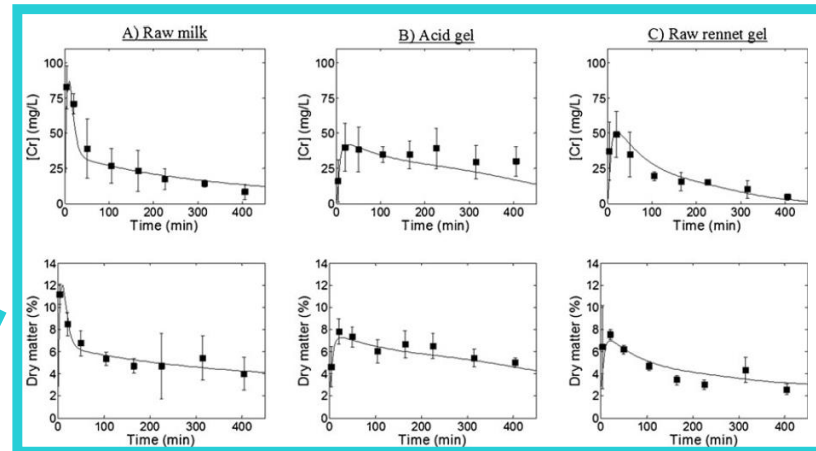
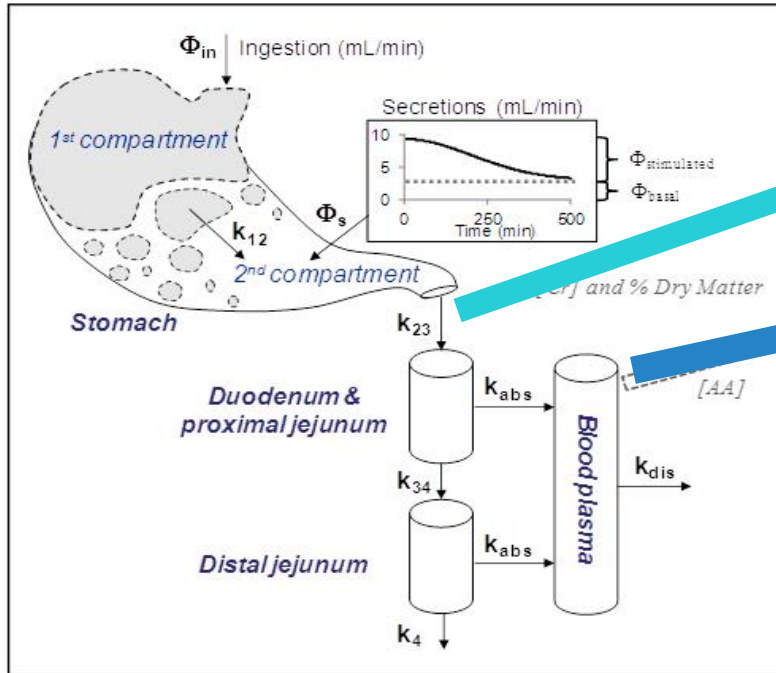

Contrasted gastric emptying kinetics seem a good explanation

- 20 to 22 model parameters: 3 to 6 unknown
- 3 data sets ([Cr], % dry matter, [AA]) fitted simultaneously for each food matrix

Prediction of unobserved quantities

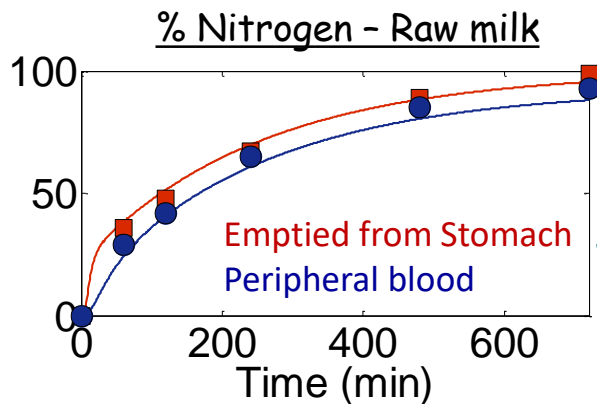
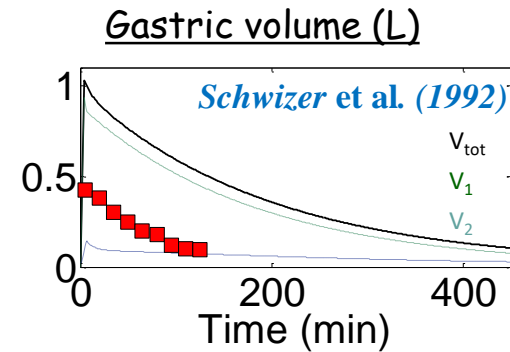
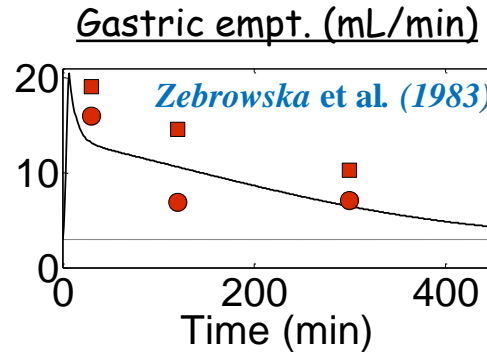
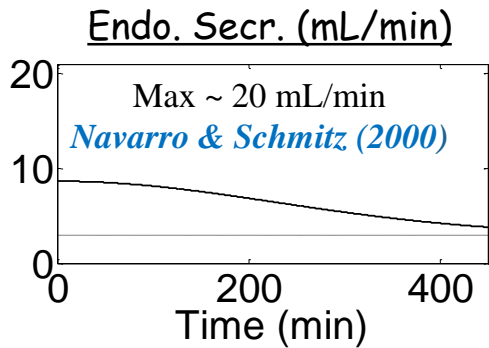

Gaudichon et al. (1994)

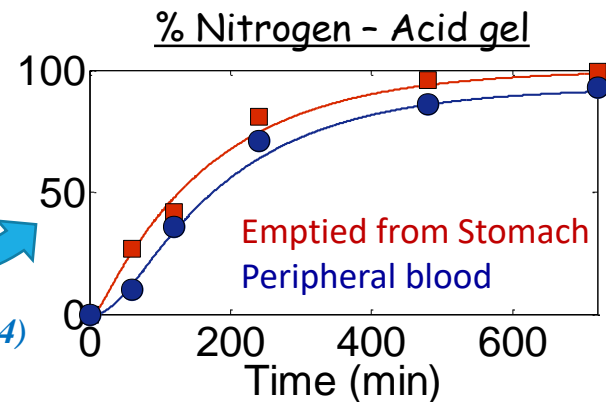

Conclusions

In silico models can be good complements to *in vitro* and *in vivo* studies, in particular to:

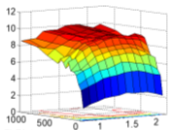
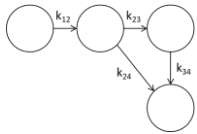

- Gather and structure the available knowledge
- Test our understanding on the mechanisms
- Extract hidden information from the results (e.g. gastric secretions and emptying fluxes...)
- Make predictions

but should also remain simple enough (not too many degrees of freedom) & be stable, robust, computationally not too heavy, reusable...

MERCI

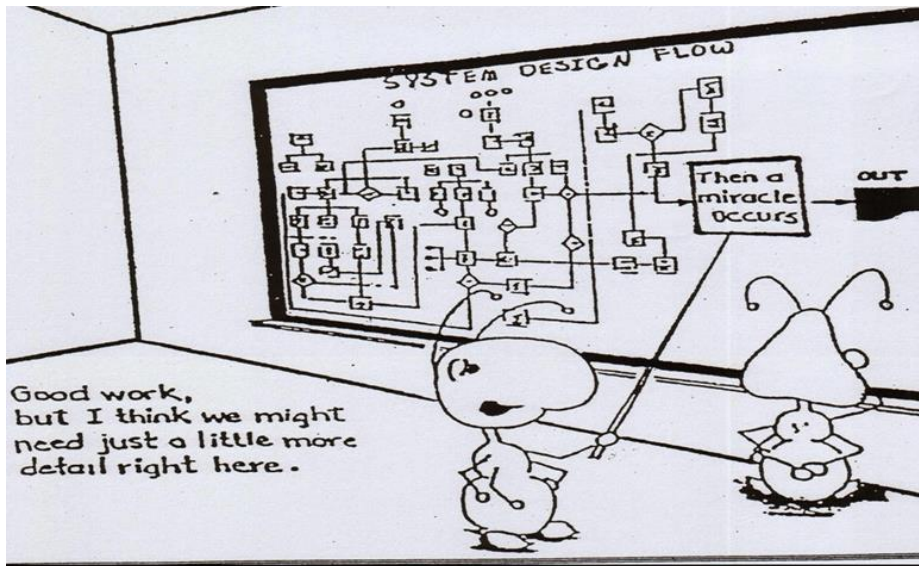

**THANK YOU FOR
YOUR ATTENTION**