



**HAL**  
open science

## Design and performance of an automated chemical extraction bench for the preparation of $^{10}\text{Be}$ and $^{26}\text{Al}$ targets to be analyzed by accelerator mass spectrometry

Karim Keddadouche, Regis Braucher, Didier Bourles, Mélanie Baroni, Valery Guillou, Laetitia Léanni, Georges Aumaitre

### ► To cite this version:

Karim Keddadouche, Regis Braucher, Didier Bourles, Mélanie Baroni, Valery Guillou, et al.. Design and performance of an automated chemical extraction bench for the preparation of  $^{10}\text{Be}$  and  $^{26}\text{Al}$  targets to be analyzed by accelerator mass spectrometry. Nuclear Instruments and Methods in Physics Research Section B: Beam Interactions with Materials and Atoms, 2019, 456, pp.230-235. 10.1016/j.nimb.2019.04.002 . hal-02092312

**HAL Id: hal-02092312**

**<https://hal.science/hal-02092312v1>**

Submitted on 25 Oct 2021

**HAL** is a multi-disciplinary open access archive for the deposit and dissemination of scientific research documents, whether they are published or not. The documents may come from teaching and research institutions in France or abroad, or from public or private research centers.

L'archive ouverte pluridisciplinaire **HAL**, est destinée au dépôt et à la diffusion de documents scientifiques de niveau recherche, publiés ou non, émanant des établissements d'enseignement et de recherche français ou étrangers, des laboratoires publics ou privés.



Distributed under a Creative Commons Attribution - NonCommercial 4.0 International License

Karim Keddadouche<sup>1</sup>, Régis Braucher<sup>1</sup>, Didier L. Bourlès<sup>1</sup>, Mélanie Baroni<sup>1</sup>, Valéry Guillou<sup>1</sup>,  
Laëtitia Léanni<sup>1</sup>, Georges Aumaître<sup>1</sup>.

1 - Aix-Marseille Univ., CNRS, IRD, INRA, Coll France, UM 34 CEREGE, Technopôle de l'Environnement Arbois-Méditerranée, BP80, 13545 Aix-en-Provence, France.

## Abstract

The growing number of studies based on data provided by the accelerator mass spectrometry (AMS) technique from increasingly diverse matrices implies that developing very effective and reproducible sample processing techniques is crucial to meet the demand generated.

After being dissolved, the isolation of the cosmogenic nuclide to be measured and its chemical purification imply complex processes throughout successive stages. The presented automatic system was designed to perform the final steps of the  $^{10}\text{Be}$  and  $^{26}\text{Al}$  chemical extraction protocol from natural matrices (sediments, pure mineral phases,...), previously purified, decontaminated and dissolved in the case of in situ-produced cosmogenic nuclides, or leached or dissolved in the case of meteoric cosmogenic nuclides. Driven by Labview software, the developed automatic system, in addition to freeing the operator from tedious tasks, allows reproducibly processing simultaneously up to eight samples of different volumes in roughly 40 minutes. This article presents the design of the automated extraction bench and its performance based on the recovery efficiency of the stable element and the reproducibility of the measurements of the cosmogenic nuclide concentrations by AMS.

## 1. Introduction

Since its development in the late 1970's [1], the AMS technique continuously improved, notably its sensitivity gained orders of magnitude. This made possible in the mid-1980's [2] to measure the minute concentrations of cosmogenic nuclides produced within the pertinent mineral lattices of rocks exposed at the Earth's surface. This possibility of measuring concentrations of the so-called « in situ-produced » cosmogenic nuclides revolutionized the study of landscape evolution through accurate quantifications of exposure durations or rates of denudation of surfaces exposed to cosmic radiations. However, until the physical parameters governing the production of the cosmogenic nuclides as a function of depth were not well-constrained, the scope of the studies was limited by the need to make strong assumptions about either duration of exposure to determine denudation rates (maximum denudation rate) or denudation rates to determine durations of exposure (minimum exposure

duration) [3]. This dramatically changed in the early 2000's when both the attenuation lengths of the cosmic-rays derived particles (neutrons and muons) responsible for the production of the cosmogenic nuclides at the surface and in the upper few meters of rock below it were accurately constrained [4,5] and a depth-profiling technique developed [6]. The methodology based on these improvements indeed allows quantifying both the denudation rates and the exposure durations of surface deposits through modelling of the measured decrease with depth of in situ-produced cosmogenic nuclides concentrations using an inversion method. As a consequence of all these innovative refinements, the number of samples to process exponentially increased due to fact that not only the depth profiles must be as constrained as possible but also because in many cases both the  $^{10}\text{Be}$  and the  $^{26}\text{Al}$  concentrations have to be measured all along the profiles to decrypt the history of the exposure to the cosmic-ray particles.

Therefore, the necessity to conceive and develop an apparatus able to handle reproducibly all the repetitive steps of the sample preparation procedure, appears essential in order to respond to the increasing demand of analyses.

## **2. Automated bench principles and conception**

### *2.1 Process description*

All matrices whose concentration in cosmogenic nuclide(s) intended to be measured by the AMS technique undergo physico-chemical processing to produce the chemical species selected either because they lead to the best ionization efficiency in the ion source ( $\text{BeO}^+$ ) or to eliminate the isobar in the ion source ( $\text{Al}$ ). The final steps of the  $^{10}\text{Be}$  and  $^{26}\text{Al}$  chemical extraction rely on the column chromatography separation technique to separate these cosmogenic nuclides. The difference in affinity of the solutes with respect to the stationary phase contained in the column causes, by repeated sorption and desorption during percolation, a gradual separation of the elements. The stationary phase used in this protocol is a cation exchange resin.

#### *2.1.1 Manual chemical extraction protocol ( $^{10}\text{Be}$ and $^{26}\text{Al}$ )*

The experimental set-up includes, for each sample, a column filled with ~ 12 ml of cationic Dowex 50WX8 type resin surmounted by a funnel maintained on a rack and three beakers collecting the successive selected fractions that contain Boron, Beryllium and Aluminum.

Following the sequences presented Figure 1, after having washed, first with water and then with 1N hydrochloric acid, the resin contained in each column, the operator i/ injects the solution resulting from the sample dissolution or leaching; ii/ successively pours different volumes of hydrochloric acid 1N to eluate Be and 4.5N to eluate Al into each column; and, finally, iii/ recovers the different fractions (Boron, Beryllium, Aluminum) in beakers. The different elution volumes pass through the column under the combined effect of gravity and atmospheric pressure. This induces a more or less

slow drop-by-drop extraction according to the type of sample. This step may sometimes require more than three hours, which is always tedious and demands a great attention of the operator in order to strictly respect the sequence and to fully recover the fractions of interest. In addition, the manipulation of concentrated hydrochloric acid could be dangerous for the operator and damage the material.

### 2.1.2 Issues

- This operation is long, time consuming and tedious. In addition, it requires a high concentration of the operator in order to strictly follow the sequence and recover the fractions of interest at the right time for each treated sample.
- Each volume (especially the one corresponding to the "sample" solution) poured into the column (1 to 2 mm above the resin level) must be eluted almost completely before the next volume can be added.
- The injection volume of the "sample" solution, usually 2ml, may vary from 1.5 to 10 milliliters, depending both on the mass of sample processed and on the solubility of the sample.
- Stationary phase (resin) is for single use only.
- The repeated handling of hydrochloric acid may be perilous for the operator and damaging for the equipment.
- The different elution volumes which pass through the column under the effect of gravity and atmospheric pressure induce a more or less slow drip extraction depending on the type of sample, the settling of the resin and the volumes poured.

### 2.1.3 Proposed resolution

Because it follows a simple and repetitive protocol, the chromatographic separation and purification of the cosmogenic radionuclides of interest, namely  $^{10}\text{Be}$  and  $^{26}\text{Al}$ , is automatable. Therefore, to significantly increase the number of samples that can be processed in a given period of time and thus meet the growing demand for analyzes, an automated system able to reproducibly process simultaneously up to eight samples of different volumes in a short run time period was designed and developed, freeing in addition the operator from these tedious tasks.

### 2.1.4 Automated chemical extraction protocol ( $^{10}\text{Be}$ and $^{26}\text{Al}$ ).

The proposed solution (Fig. 2) retains the initial process. Once the columns loaded with resin and equipped with a reservoir, a peristaltic pump distributes the type of eluent selected (water or hydrochloric acid of different molarities) from a three-way solenoid valve through an eight-way solenoid valve to each funnel. After the resin rinsing and conditioning, eight peristaltic pumps perform the simultaneous injection of eight samples to their dedicated funnel. These pumps distribute

at a constant rate, the different sample volumes according to a fixed pumping time. After the injection of the sample, the first fraction eluted using the pertinent HCl 1N volume which elutes  $^{10}\text{B}$ , the interfering isobar of  $^{10}\text{Be}$ , is directed to the beaker "trash" which already collected the rinsing and conditioning solutions. Eight three-way valves ensure the collection of the fractions of interest containing first the  $^{10}\text{Be}$  and then the  $^{26}\text{Al}$  in two separate beakers, according to the HCl 1N and then 4N volumes injected. In this prototype one peristaltic pump is in operation to distribute the needed volume of elution solution.

All beakers are contained in a sealed rack maintained under a slight depression by a diaphragm pump in order to accelerate the drop-by-drop and therefore the transfer to the column outlet.

A level sensor (Fig. 3) located within the funnel five centimeters above the zero level sets as the upper bound of the resin in the column, validates the elution of each volume and conditions the transition to the next step. The remaining volume is eluted according to a fixed time transition until complete elution.

The control of the system is managed by a C / rio machine from National Instrument. Finally, the sequential and whole execution of the determined process is supervised by a LABVIEW program (Fig. 4).

## 2.2 Selected components

The use of hydrochloric acid requires that the various parts in direct contact with the eluent (pump, tubing, sensors, solenoid valves ...) are chemically compatible materials (PMMA, PTFE, PP).

Given the surrounding atmosphere (chemical laboratory), the bench prototype is designed in a workable and chemically resistant (PP) material. The electrical box accommodating all the electrical equipment and the automat located at the rear of the bench is sealed and maintained under slight pressure of inert gas (nitrogen) to prevent the intrusion of acidic vapors.

Peristaltic pumps drive the liquid by the action of a roller rotating at a constant speed and exerting pressure on a flexible tube. The advantage of this technique is, on the one hand, the wide variety of material type and diameter of the tubes to achieve this operation and, on the other hand, these pumps delivering a constant flow, minimal maintenance (change worn tubes, ...) is required. The structure of the multi-way solenoid valves (three and eight) is designed in such a way that the fluid does not come into contact with the metal parts of the solenoid valve, thanks to the isolation of the valve and the membrane mechanism. Highly inert materials such as PTFE, PEEK, PPS, etc., are used for the parts in contact with the fluid that make these solenoid valves compatible with a wide range of liquid. Each of them has a common port and as much output as necessary. Level sensors are screwed onto each funnel to detect the presence of liquid five centimeters above the resin bed. The immersed part of the

sensor is made of chemically resistant materials (Polysulphone). The fraction collector is a PVC rack, consisting of twenty-four compartments (three per sample) and equipped with a vacuum gauge to control the vacuum produced by the diaphragm vacuum pump.

### **3. Automated bench performances.**

#### ***3.1. Experiment 1: Automatic Process Verification***

This experiment aims to determine if the automated extraction bench: i/ strictly follows the planned procedure, ii/ allows performing separations identical to the manual ones in a reduced time. It consists first in injecting a synthetic solution containing 1000 µl of a boron solution (1000 ppm), 300 µl of a beryllium solution (1000 ppm) and 1000 µl of an aluminum solution (1000 ppm) in a column loaded with 12 ml of a Dowex 50WX8 cation exchange resin, then to regularly collect each fraction of 10 ml at the outlet of the column to be analyzed on an Thermo ICAP6500, Inductively Coupled Plasma-Optical Emission Spectrometer (ICP-OES) to reconstitute an overall chromatogram (the efficiency of the separation of the elements of interest depending on the type, concentration and volume of the selected eluent (Fig. 6).

The results obtained demonstrate that the automated process allows obtaining a separation of the chemical species identical to those obtained performing the manual protocol, the collected volumes and concentrations of the different elements of interest being in addition comparable, but with a significantly reduced execution time. Currently, the entire process (rinsing and activation of the resin, boron, beryllium and aluminum elutions) is performed in 40 minutes with this prototype instead of the 2 hours usually needed by an operator.

#### ***3.2 Experiment 2: Extraction yields.***

Despite the fact that  $^{10}\text{Be}$  and  $^{26}\text{Al}$  concentrations are determined from isotopic ratios measured by AMS and thus the yield of the chemical preparation will not affect the measured ratios, it is however important to estimate how much amount of nuclide, initially present in a natural sample is recovered through the entire preparation process. In the case of the automated bench, does the depression forcing the liquid phase to pass through the resin, affect the yield of extraction? To answer this question, a large amount of snow coming from the Talos Dome station in Antarctica, has been melted and separated in 10 subsamples of ~150g each. Each subsample received a weighted amount of a commercial  $^9\text{Be}$  carrier. Five of these subsamples plus a blank sample underwent a beryllium extraction in normal conditions i.e. with an operator following the classical method of Baroni et al. (2011) [8] and five of them were prepared using the automated bench with an associated blank sample.

All samples have been eluted with 18 mL of HCl (3M). From these 18ml and for each subsample, an aliquot has been taken, diluted 9 times and  $^9\text{Be}$  concentration were determined by ICP-OES. The

extraction yields from both the manual and automated extractions were determined by dividing the initial beryllium content ( $^9\text{Be}$  carrier) and the final one determined by ICP-OES. Results are presented in table 1.

The mean extraction yield obtained with the automated bench is  $93.9 \pm 0.9 \%$ , in agreement with the one calculated for the classical method,  $95.6 \pm 4.1 \%$ .

One of the yields of the classical protocol is higher than 100% (sample 3) but within the variability, it may simply indicate a total recovery of the  $^9\text{Be}$  in that case.

At this stage, based on the extraction yield and because  $^9\text{Be}$  and  $^{10}\text{Be}$  have strictly identical chemical properties, one can conclude that the automated extraction bench is efficient and reproducible. The efficiency values obtained from the automated extraction are also less dispersed than those obtained by the conventional method.

### 3.3 Experiment 3: Validation by Accelerator Mass Spectrometry

In order to verify the reproducibility of the automated process, the isotopic ratio of the cosmogenic radionuclide (in our case,  $^{10}\text{Be}$ ) over that of its stable isotope (in our case,  $^9\text{Be}$ ) was measured by AMS following two separation experiments performed using the automated chemical extraction bench on two solutions.

The first solution to be injected was a calibrated standard (KNSTD13), usually used in AMS and whose calibrated isotopic  $^{10}\text{Be}/^9\text{Be}$  ratio is  $5.24 \times 10^{-13}$ . After collection, the final beryllium fractions were evaporated, the residues dissolved in 1N HCl, the solubilized beryllium precipitated as  $\text{Be}(\text{OH})_2$  before to be oxidized to  $\text{BeO}$  at  $800^\circ\text{C}$  during 1 hour.

In a second time, all solutions prepared for the tests of the extraction yields (section 3.2) plus two new (samples 11 and 12) were analyzed by AMS. The results are presented in table 2 and related to the description in table 1: the subsamples 1 to 5, 11, the Blanks 1 and 2, were prepared classically [8] and the subsamples 6 to 10, 12, the Blanks 3 and 4 were prepared with the automated bench. All beryllium oxides ( $\text{BeO}$ ) were finally mixed with Niobium powder and pressed in copper cathodes. The AMS analyses were performed at French national facility ASTER (Aix-en-Provence) using NIST SRM4325 standard. The results are presented in table 2.

The three measured values for the KNSTD13 solutions as well as all concentrations excepted that of sample 7, measured from snow samples (figure 7) being identical considering the associated uncertainties, one can conclude that the automated bench is reliable for the sample preparation aiming at measuring  $^{10}\text{Be}/^9\text{Be}$  ratios. Blank ratios obtained from the automated bench are identical to the one prepared manually by an operator. Despite the same extraction yield obtained from the automated extraction, the AMS measurement performed on sample 7 highlights a  $^{10}\text{Be}$  concentration

significantly lower than those measured for all samples (Fig. 7). As already observed for similar cases, this discrepancy results from an error of the manipulator during the last stages of the preparation of the sample (precipitation) and its sintering in the cathode following the separation and the purification carried out by the automated bench and which leads to a too small amount of BeO to be able to perform an AMS measurement that we have nevertheless attempted.

### 3.4 Experiment 4: Influence of the state of the stationary phase on the separation.

During manual preparation, the stationary phase (resin) is kept submerged without contact with air. This experiment measured the influence of the state of the stationary phase on the separation of the elements. At each step, from the detection threshold imposed by the sensor, the collector sucks the remaining volume according to a time parameterized in the sequence. Because of the imperfections of the connecting tubing and, more importantly, because of the viscosity specific to each sample, the elution rate through the eight treatment channels may differ slightly. This can cause fluctuations in the level of residual eluent over the resin or its partial or total drying. In the first case, this would generate difficulties at the time of the injection because the residual eluent would significantly increase (double) the volume of the sample (1.5 ml), changing the time necessary for its total elution from the column and, therefore, a partial loss of the sample. In the second case, the dewatering of the resin can create preferential paths within the resin, modifying the interaction between the eluent and the resin and, thus, influencing the separation of the compounds.

During this experiment, the collection time has been modulated to submit the stationary phase to the following three states:

1. Eluent completely sucked up to the raz of the resin;
2. Dry resin;
3. 2 millimeters of residual eluent above the resin.

The results are presented in table 3.

In order to benefit from a good sensitivity to investigate the effect of the state of the stationary phase on the separation, the processed sample was a chemical blank (containing only  $^9\text{Be}$ ). The measurements are statistically comparable considering the associated uncertainties. This demonstrates that the state of the stationary phase does not significantly disturb the separation. However, for a better control of the process, it would be preferable to implant a technical solution allowing detection the level of the eluent flush relative to the level of the resin.

## **4 Conclusions and perspectives**



Driven by Labview software, an automated bench has been designed to perform the tedious and repetitive tasks in the final steps of  $^{10}\text{Be}$  and  $^{26}\text{Al}$  cosmogenic sample preparation. In addition to freeing the operator, this system allows  $^9\text{Be}$  yields as high as those obtained manually (>93 %), it is reproducible and permits processing simultaneously up to eight samples of different volumes in roughly 40 minutes to be compared to the three hours when processed manually.

In a near future it is planned to improve the system adding one elution pump per sample which will allow a significant time reduction of the process and manufacture a new instrumented column designed with level sensor detection the closest as possible of the top of the resin. Furthermore, a resin regeneration step will be added at the end of the extraction protocol to reduce both the time dedicated to the machine starting set-up and the costs of preparation. A commercial version of this automated will be soon available patented under the following designations and references: *Apparatus for separating chemical compounds present in a sample with a corrosive eluent*. K. Keddadouche, D. Boulès, R Braucher. Patents No.: FR2016/050505; EP16 712,961.8 and WO2016142609 (A1).

## 5 Acknowledgments.

ASTER AMS national facility (CEREGE, Aix-en-Provence) is supported by the INSU/CNRS, the ANR through the "Projets thématiques d'excellence" program for the "Equipements d'excellence" ASTER-CEREGE action, IRD. The authors thank the NERYS industry, C. Couvert and T. Pugliesi and INOVAPLAST Industry, F.Aniel and J-B. Richemont for their valuable help in the assemblage of the automated bench

## References.

- [1] Raisbeck, G.M., Yiou, F., Fruneau, M., and Loiseaux, J.M., 1978, Beryllium-10 mass spectrometry with a cyclotron: *Science*, v. 202, p. 215–217,
- [2] Klein, J., Geigengack, R., Middleton, R., Sharma, P., Underwood, J., and Weeks, R., 1986, Revealing histories of exposure using in situ produced  $^{26}\text{Al}$  and  $^{10}\text{Be}$  in Libyan Desert Glass: *Radiocarbon*, v. 28, no. 2A, p. 547–555
- [3] Lal, D., 1988, In situ-produced cosmogenic isotopes in terrestrial rocks: *Annual Reviews of Earth and Planetary Sciences*, v. 16, p. 355-388, doi:10.1146/annurev.earth.16.050188.002035
- [4] R. Braucher E.T. Brown, D.L. Boulès and F. Colin - In Situ - Produced  $^{10}\text{Be}$  Measurements at Great Depths: Implications for Production Rates by Fast Muons - *Earth and Planetary Science Letters* 211 (3-4), 251-258, 2003

- [5] R. Braucher, D.L. Bourlès, S. Merchel, J. Vidal-Romani, D. Fernandez-Mosquera, K. Marti, L. Léanni, F. Chauvet, M. Arnold, G. Aumaître and K. Keddadouche - Determination of Muon Attenuation Lengths in Depth Profiles From In Situ Produced Cosmogenic Nuclides - Nuclear Instruments and Methods in Physics Research Section B: Beam Interactions with Materials and Atoms B294, 484-490, 2013
- [6] L. Siame, O. Bellier, R. Braucher, M. Sébrier, M. Cushing, D.L. Bourlès, B. Hamelin, E. Baroux, B. de Voogd, G.M. Raisbeck and F. Yiou –Local Erosion Rates Versus Active Tectonics: Cosmic Ray Exposure Modelling in Provence (South-East France) – Earth and Planetary Science Letters 220, 354-364, 2004
- [7] K. Keddadouche, D. Bourlès, R Braucher. Apparatus for separating chemical compounds present in a sample with a corrosive eluent. Patents n°: FR2016/050505; EP16 712 961.8 and WO2016142609 (A1).
- [8] M. Baroni, E. Bard, J.R. Petit, O. Magand, D. Bourlès. Volcanic and solar activity and atmospheric circulation influences on cosmogenic  $^{10}\text{Be}$  fallout at Vostok and Concordia (Antarctica) over the last 60 years. *Geochimica Et Cosmochimica Acta* - 75. 7132-7145. (2011).

Table1: Concentration of beryllium before and after extractions (classical and automated) and corresponding yields in 10 snow samples and two blanks.

Table 2: AMS measurements of snow samples and KNSTD13

Table 3: Measurements of three blank samples prepared using the automated bench under three different conditions (see text).

Figure 1: Chronology of the different steps involved in the sequential elution of boron, beryllium and aluminum through the cationic resin.

Figure 2: Scheme of the automated chemical extraction bench.

Figure 3: Instrumented funnel and column.

Figure 4: Control interface LABVIEW.

Figure 5: The patented automated chemical extraction bench prototype [7].

Figure 6: Elution diagram of boron and beryllium using 1N HCl and of aluminum with 4.5N HCl monitored by ICP/OES measurements.

Figure 7:  $^{10}\text{Be}$  concentrations of snow samples prepared manually (1,2,3,4,5,12; black dots) and with the automated bench (6,7,8,9,10,11, triangles); sample 7 is considered as outlier (black triangle). Horizontal black and dashed lines are the mean values with their 1 sigma uncertainties.

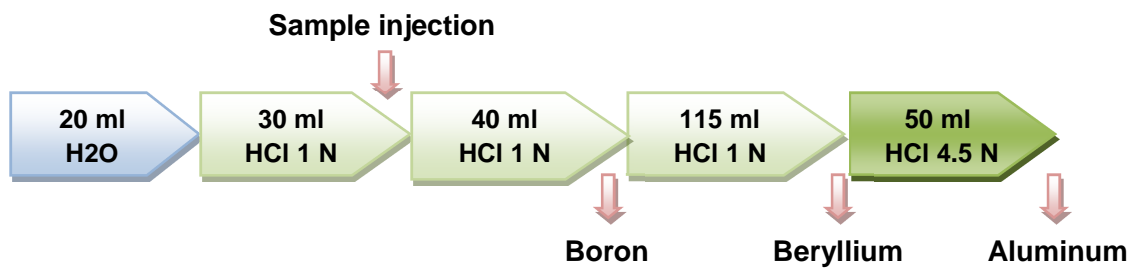

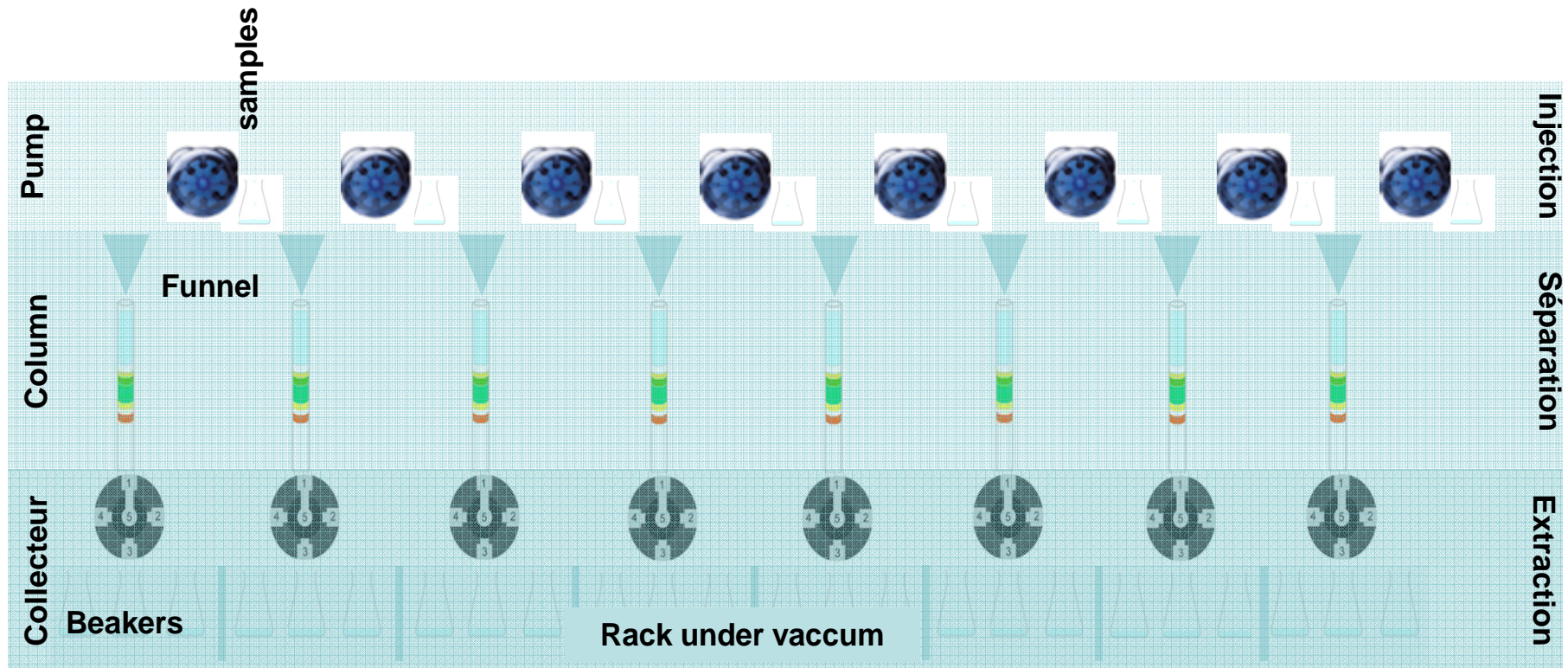
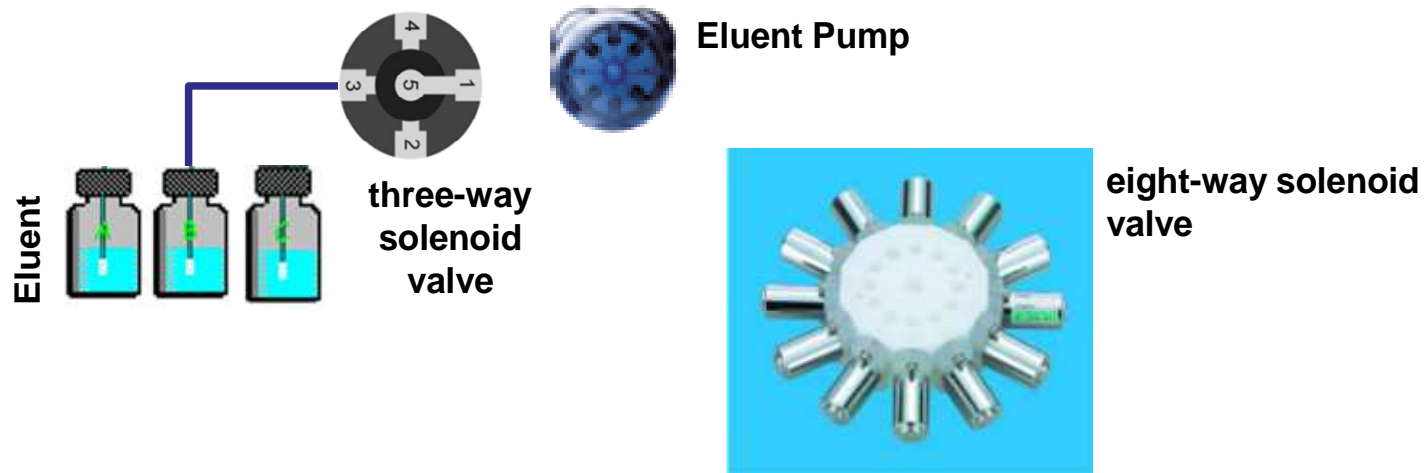

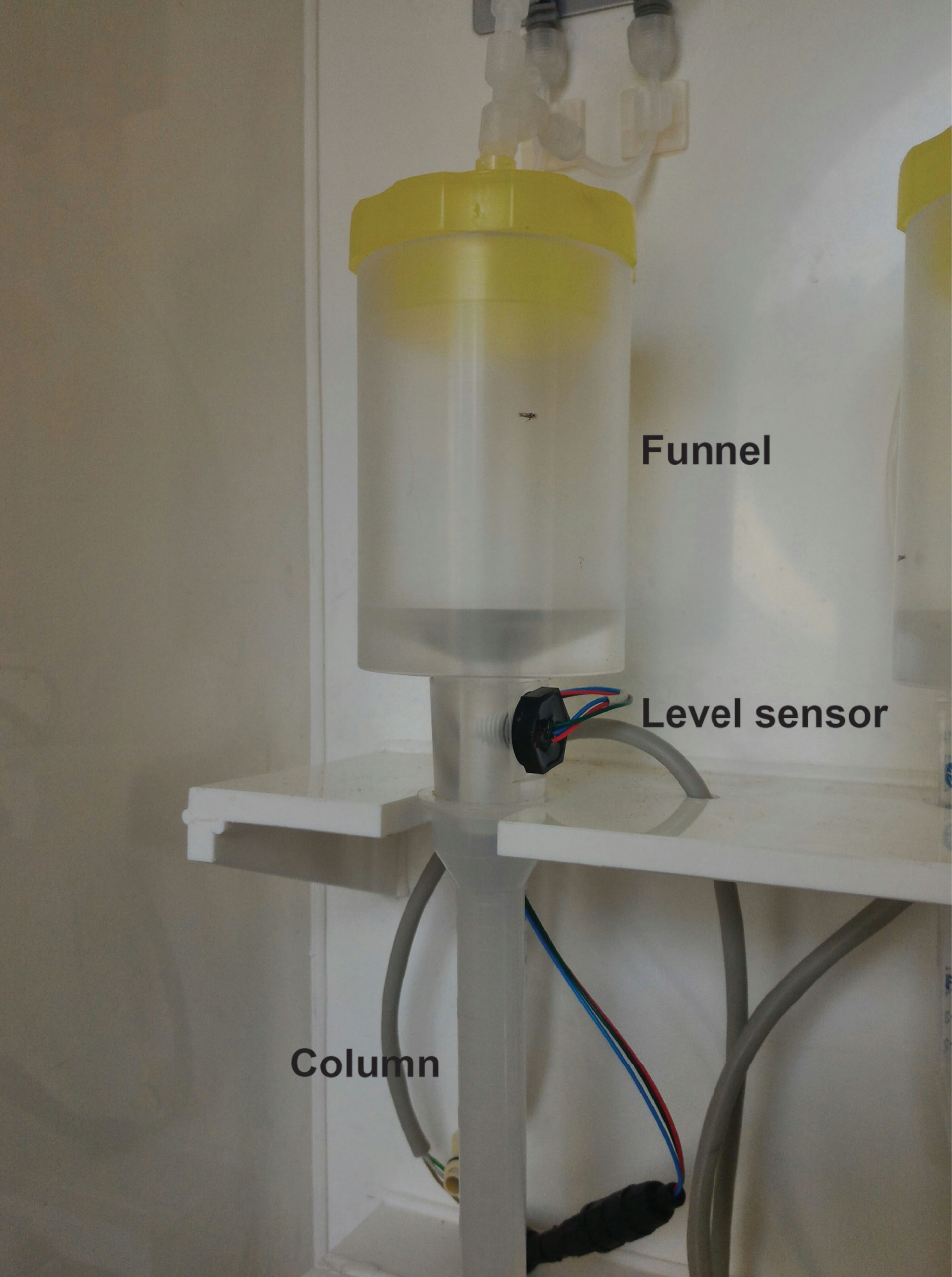

**Funnel**

**Level sensor**

**Column**

Eluant selection

8 Ways selectors

Elution volume

Injection Volumes

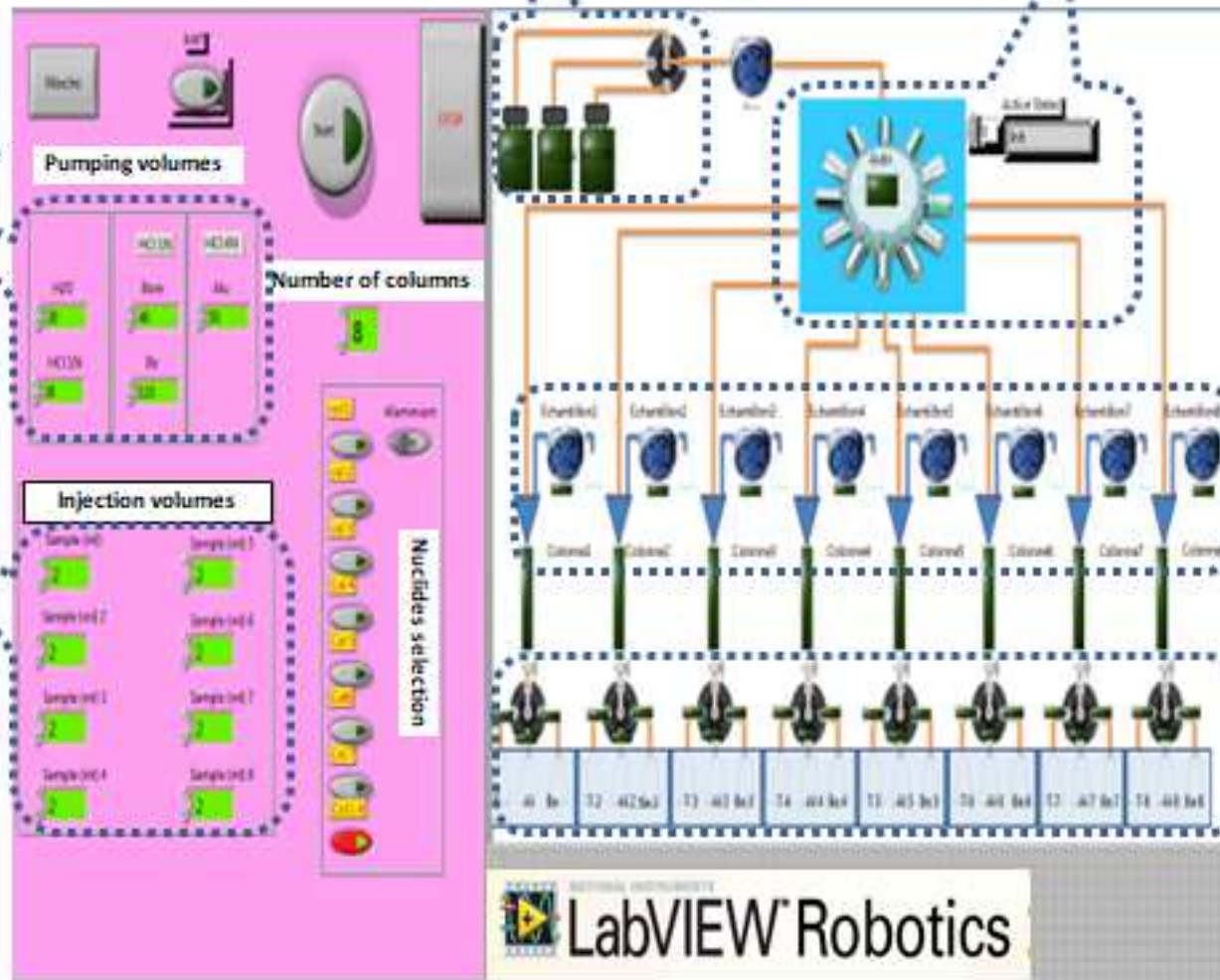

Monitored Injection

vacuum fractions extractor

LabVIEW Robotics



Front panel



Back panel





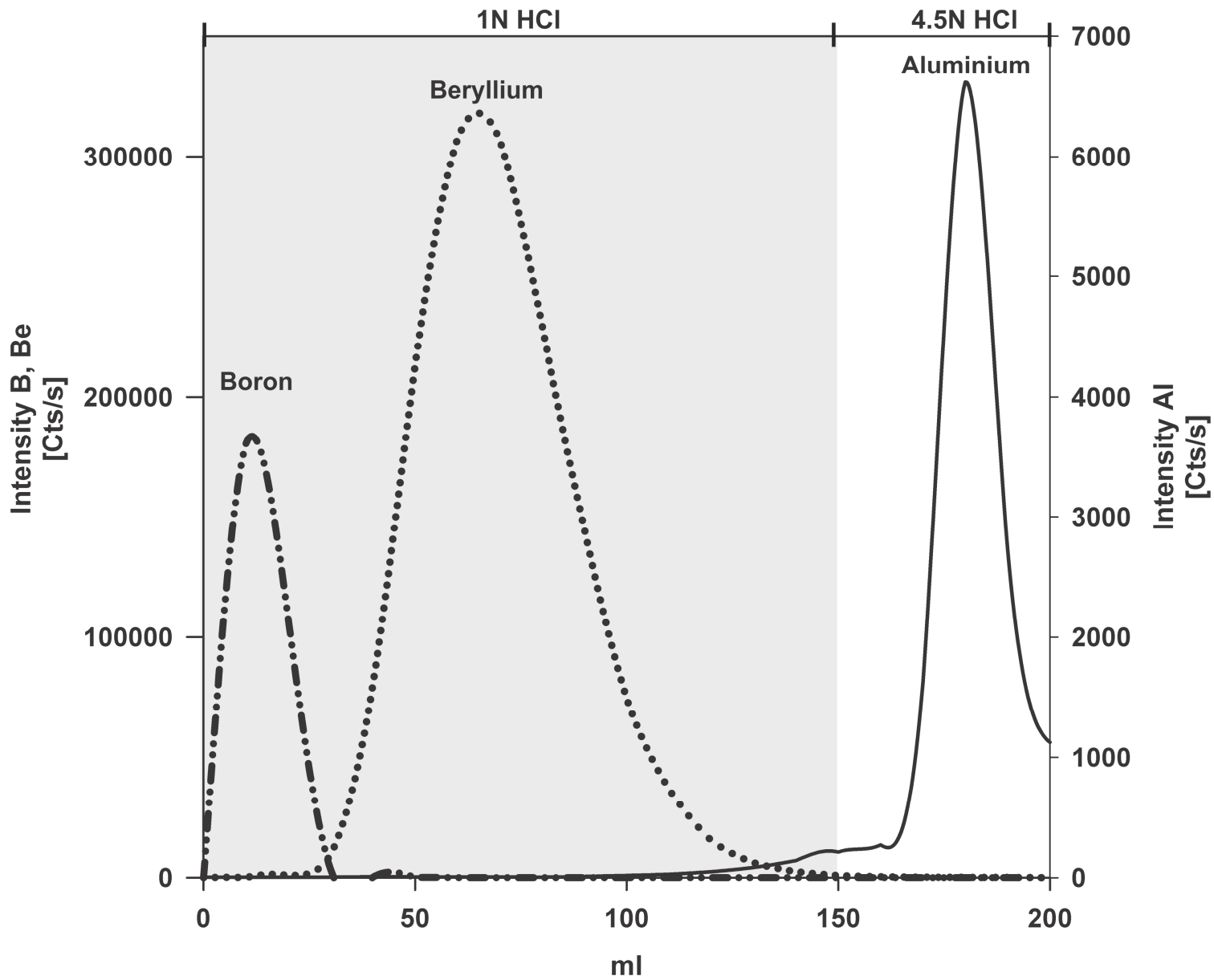

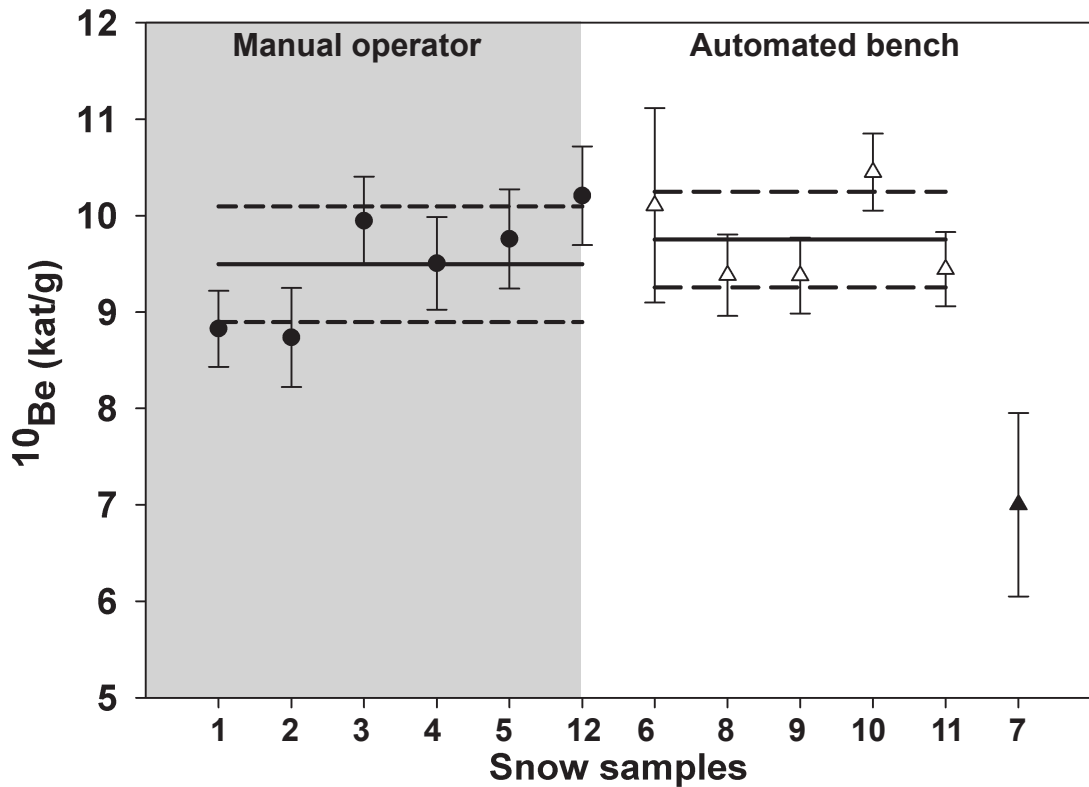

Method	Sample	<sup>9</sup> Be added (10 <sup>-5</sup> mol)	<sup>9</sup> Be measured (10 <sup>-5</sup> mol)	Yield (%)	Average (%)	Std Deviation (%)
Classical	Blank 1	2.79	2.63	94.2	95.6	4.1
	1	2.79	2.64	94.7		
	2	2.76	2.53	91.4		
	3	2.78	2.87	103.2		
	4	2.78	2.68	96.5		
	5	2.78	2.60	93.5		
Automated bench	Blank 2	2.78	2.64	94.9	93.9	0.9
	6	2.78	2.64	94.8		
	7	2.78	2.61	94.1		
	8	2.78	2.60	93.6		
	9	2.78	2.57	92.5		
	10	2.78	2.60	93.7		

Method	Sample Name	Measured $^{10}\text{Be}/^9\text{Be}$	Uncertainty (%)	$^{10}\text{Be}^{**}$ kat/g
Classical	Blank 1*	7.46E-15	21.5	< 1.1
	1	8.21E-14	4.5	8.8 ± 0.4
	2	8.741E-14	5.9	8.7 ± 0.5
	3	9.96E-14	4.7	9.9 ± 0.5
	4	9.23E-14	5.1	9.5 ± 0.5
	5	9.14E-14	5.3	9.8 ± 0.5
	11	9.29E-14	5.0	10.2 ± 0.5
	Blank 2	4.38E-15	20.7	< 0.66
Automated bench	Blank 3*	4.31E-15	14.3	<0.57
	6	9.47E-14	9.9	10.1 ± 1
	7	6.31E-14	13.6	7.0 ± 1
	8	9.07E-14	4.5	9.4 ± 0.4
	9	8.51E-14	4.12	9.4 ± 0.4
	10	1.07E-13	3.9	10.5 ± 0.4
	12	9.02E-14	4.1	9.4 ± 0.4
	Blank 4*	5.60E-15	16.7	< 0.74
	KUNI 1	5.21x10 <sup>-13</sup>	3.0	n.a.
	KUNI 2	5.12x10 <sup>-13</sup>	3.1	n.a.
	KUNI 3	5.28x10 <sup>-13</sup>	3.1	n.a.

\*: Blank 1 is associated to samples 1 to 5; Blank 2 to sample 11, Blank 3 to samples 6-to10 and Blank 4 to sample 12. \*\*  $^{10}\text{Be}$  concentrations are blank corrected. Blank concentrations are upper limits.

<b>Sample characteristic</b>	<b><math>^{10}\text{Be}/^9\text{Be}</math></b>	<b><math>^{10}\text{Be}/^9\text{Be}</math> uncertainty (%)</b>
Normal	<b><math>4.83 \times 10^{-15}</math></b>	15.1
Dry	<b><math>4.08 \times 10^{-15}</math></b>	18.6
Residual eluent	<b><math>5.78 \times 10^{-15}</math></b>	13.1