



**HAL**  
open science

## **Nash Stable Outcomes in Fractional Hedonic Games: Existence, Efficiency and Computation**

Vittorio Bilò, Angelo Fanelli, Michele Flammini, Gianpiero Monaco, Luca  
Moscardelli

► **To cite this version:**

Vittorio Bilò, Angelo Fanelli, Michele Flammini, Gianpiero Monaco, Luca Moscardelli. Nash Stable Outcomes in Fractional Hedonic Games: Existence, Efficiency and Computation. *Journal of Artificial Intelligence Research*, 2018, 62, pp.315-371. 10.1613/jair.1.11211 . hal-02089363

**HAL Id: hal-02089363**

**<https://hal.science/hal-02089363>**

Submitted on 3 Apr 2019

**HAL** is a multi-disciplinary open access archive for the deposit and dissemination of scientific research documents, whether they are published or not. The documents may come from teaching and research institutions in France or abroad, or from public or private research centers.

L'archive ouverte pluridisciplinaire **HAL**, est destinée au dépôt et à la diffusion de documents scientifiques de niveau recherche, publiés ou non, émanant des établissements d'enseignement et de recherche français ou étrangers, des laboratoires publics ou privés.

# Nash Stable Outcomes in Fractional Hedonic Games: Existence, Efficiency and Computation

**Vittorio Bilò**

*Department of Mathematics and Physics  
University of Salento  
Lecce, Italy*

VITTORIO.BILO@UNISALENTO.IT

**Angelo Fanelli**

*CNRS, (UMR-6211)  
Caen, France*

ANGELO.FANELLI@UNICAEN.FR

**Michele Flammini**

*GSSI Institute &  
Department of Information Engineering  
Computer Science and Mathematics  
University of L'Aquila  
L'Aquila, Italy*

MICHELE.FLAMMINI@UNIVAQ.IT

**Gianpiero Monaco**

*Department of Information Engineering  
Computer Science and Mathematics  
University of L'Aquila  
L'Aquila, Italy*

GIANPIERO.MONACO@UNIVAQ.IT

**Luca Moscardelli**

*Department of Economic Studies  
University of Chieti-Pescara  
Pescara, Italy*

LUCA.MOSCARDELLI@UNICH.IT

## Abstract

We consider fractional hedonic games, a subclass of coalition formation games that can be succinctly modeled by means of a graph in which nodes represent agents and edge weights the degree of preference of the corresponding endpoints. The happiness or utility of an agent for being in a coalition is the average value she ascribes to its members. We adopt Nash stable outcomes as the target solution concept; that is we focus on states in which no agent can improve her utility by unilaterally changing her own group. We provide existence, efficiency and complexity results for games played on both general and specific graph topologies. As to the efficiency results, we mainly study the quality of the best Nash stable outcome and refer to the ratio between the social welfare of an optimal coalition structure and the one of such an equilibrium as to the price of stability. In this respect, we remark that a best Nash stable outcome has a natural meaning of stability, since it is the optimal solution among the ones which can be accepted by selfish agents. We provide upper and lower bounds on the price of stability for different topologies, both in case of weighted and unweighted edges. Beside the results for general graphs, we give refined bounds for various specific cases, such as triangle-free, bipartite graphs and tree graphs. For these families, we also show how to efficiently compute Nash stable outcomes with provable good social welfare.

## 1. Introduction

In many economical, social and political situations, individuals carry out activities in groups rather than by themselves. In these scenarios, understanding the “happiness” of each member becomes of crucial importance. As an example, the utility of an individual in a group sharing a resource depends both on the consumption level of the resource and on the identity of the members in the group. Similarly, the utility for a party belonging to a political coalition depends both on the party trait and on the identity of its members. Not surprisingly, the optimization problem of partitioning agents into coalitions so as to maximize the social welfare is a major research challenge in AI and it has been extensively investigated in the field of multi-agent systems under the name of Coalition Structure Generation (CSG). Several works characterize the computational complexity of finding optimal solutions, providing efficient algorithms, hardness results and suitable approximations under different assumptions or variants of the problem (Aziz & de Keijzer, 2011; Bachrach, Kohli, Kolmogorov, & Zadimoghaddam, 2013; Bansal, Blum, & Chawla, 2004; Deng & Papadimitriou, 1994; Ohta, Conitzer, Ichimura, Sakurai, Iwasaki, & Yokoo, 2009; Rahwan, Michalak, Wooldridge, & Jennings, 2012; Ueda, Iwasaki, Yokoo, Silaghi, Hirayama, & Matsui, 2010; Voice, Polukarov, & Jennings, 2012). A recent survey of the different approaches in this setting is also available (Rahwan, Michalak, Wooldridge, & Jennings, 2015).

Hedonic games, introduced by Dreze and Greenberg (1980), describe the dependence of an agent’s utility (or payoff) on the identity of the members of her group. They are games in which agents have preferences over the set of all possible agent coalition structures (outcomes). In particular, the utility of each agent only depends on the composition of the coalition she belongs to, without any form of externality, that is, without caring about the structure of the other coalitions. A significant stream of research (Bogomolnaia & Jackson, 2002; Banerjee, Konishi, & Sönmez, 2001; Elkind, Fanelli, & Flammini, 2016; Elkind & Wooldridge, 2009; Gairing & Savani, 2010) characterize the existence and the properties of several notions of stability in hedonic games, such as individual stability, contractual individual stability, Nash stability, core, strict core, and others. In this paper we focus on Nash stability and on the stronger notion of  $k$ -Strong Nash stability. A coalition structure is *Nash stable* if no agent can improve her utility by unilaterally changing her own coalition. Moreover, it is  *$k$ -Strong Nash stable* if no subset of at most  $k$  agents can cooperatively deviate so as to induce a benefit to all of its members. There are also examples of studies on Nash stability in hedonic games, in which self-organized coalition structures are obtained from the decisions taken by independent and selfish agents (Bloch & Diamantoudi, 2011; Feldman, Lewin-Eytan, & Naor, 2012; Gairing & Savani, 2010).

In this work, we consider the class of (symmetric) *fractional hedonic games* introduced by Aziz, Brandt, and Harrenstein (2014). These games are modeled by an undirected graph in which nodes represent agents and edge weights the happiness of the corresponding endpoints for belonging to the same coalition. The utility that agent  $i$  gets when belonging to coalition  $C$  is given by the total weight of the edges incident to  $i$  having the other endpoint in  $C$  (the total happiness of  $i$  in  $C$ ), divided by the cardinality of  $C$ , i.e., the number of its nodes. The social welfare of a coalition structure is the sum of all the agents’ utilities. Given that the utility of an agent is not simply defined as her total happiness, but as its ratio with the coalition size, fractional hedonic games can model several natural behavioral

dynamics in social environments. In particular, when defined on undirected unweighted bipartite graphs, they suitably represent a basic economic scenario in which each agent can be considered as a buyer or a seller. There are only edges connecting buyers and sellers and every agent sees the others of the same type as market competitors. In a situation of free movement, each agent prefers to be situated in a group (market) with a small number of competitors: Each buyer wants to be in a group with many sellers and few other buyers, thus maximizing their ratio, in order to decrease the price of the good. On the other hand, a seller wants to be situated in a group maximizing the number of buyers against the number of sellers, in order to be able to increase the price of the good and gain a higher profit. This scenario is referred to as *Bakers and Millers* (Aziz et al., 2014) and can be generalized to situations in which there are more than two types of agents by means of  $k$ -partite graphs.

### 1.1 Our Contribution

We investigate the class of fractional hedonic games under Nash stability. Unlike the core, in this setting, every agent cannot coordinate with the others in order to understand if she can improve her utility. Therefore, this notion of stability can be better suited in settings in which it is not possible to assume the ability of coordination. We also consider  $k$ -strong Nash stable outcomes, which differ from the core stable ones. In fact, while on the one hand an outcome is core stable if no group of agents can get an advantage in forming a new coalition by itself, on the other hand an outcome is  $k$ -strong Nash stable if no set of  $k$  agents can benefit of a deviation possibly leading them also in different coalitions (and not necessarily in the new one formed by all of them). We investigate Nash stability in fractional hedonic games with the aim of characterizing the existence, efficiency and computability of stable outcomes. Our results are described in detail in the following subsections.

#### 1.1.1 EXISTENCE

We first focus on the existence of Nash stable coalition structures. We show that, while in presence of negative weights Nash stable outcomes are not guaranteed to exist (Observation 2), with non-negative ones the basic coalition structure in which all agents belong to the same coalition (*grand coalition*) is stable (Observation 3). Thus, in the sequel we restrict to the case of non-negative edge weights. We also show that  $k$ -Strong Nash stable coalition structure are not guaranteed to exist even for unweighted graphs and  $k = 2$  (Theorem 2). These results are summarized in Table 1.

	Nash stable coalition structures	2-strong Nash stable coalition structures
unweighted	<i>always exists</i> (Observation 3)	<i>may not exist</i> (Theorem 2)
non-negative weights		
general weights	<i>may not exist</i> (Observation 2)	

Table 1: Results on the existence of Nash stable coalition structures.

### 1.1.2 EFFICIENCY

We then evaluate the performance of Nash stable outcomes by means of the widely used notions of price of anarchy (Koutsoupias & Papadimitriou, 2009) and price of stability (Anshelevich, Dasgupta, Kleinberg, Tardos, Wexler, & Roughgarden, 2008). The price of anarchy measures in a pessimistic way the efficiency loss of Nash stable outcomes. It is the worse-case ratio between the social welfare of an optimal coalition structure and the one of a Nash stable coalition structure. We give an upper bound of  $O(n)$  on the price of anarchy for weighted graphs (Theorem 3) and show that it is asymptotically tight even for unweighted paths (Theorem 4). These results are summarized in Table 2.

	lower bound	upper bound
path, unweighted	$\Omega(n)$ (Theorem 4)	$n - 1$ (Theorem 3)
general topology, weighted		

Table 2: Results on the Price of Anarchy.

We then turn our attention to the price of stability, that is the best-case ratio between the social welfare of an optimal coalition structure and the one of a Nash stable solution. A best Nash stable outcome has a natural meaning of stability, since it is an optimal solution among the ones that can be accepted by selfish agents. In fact, in many networking applications and multi-agent systems, agents are never completely unrestricted; rather, they interact with an underlying protocol that essentially proposes a collective solution to all participants, each of whom can either accept or defect. As a result, it is in the interest of the protocol designer to seek for a best outcome at equilibrium. In fact, this can naturally be viewed as the optimum, subject to the constraint that the solution has to be stable, that is with no agent having an incentive to unilaterally deviate once it is offered. We first prove a lower bound of  $\Omega(n)$  on the price of stability, holding even for weighted stars (Theorem 5), that asymptotically matches the general upper bound on the price of anarchy given in Theorem 3. Further interesting results can be achieved for unweighted graphs. In such a setting, we show a lower bound of 2 for general graphs (Theorem 6). Moreover we prove an interesting property: if a graph admits a 2-Strong Nash stable coalition structure, then its price of stability is at most 4 (Theorem 7). Even if 2-Strong Nash stable outcomes are not always guaranteed to exist (Theorem 2), such a property can be exploited to prove a constant upper bound on the price of stability for specific graphs. Finally, we consider particular topologies, such as triangle-free, bipartite and tree graphs. In particular, for triangle-free graphs we prove an upper bound of  $\frac{18}{7}$  on the price of stability (Theorem 8), and for bipartite graphs an upper bound of  $6(3 - 2\sqrt{2}) \approx 1.0294$  (Theorem 10) and a lower bound of  $\frac{400}{399} \approx 1.0025$  (Theorem 11); finally, for trees we prove that any optimal coalition structure is Nash stable, i.e., the price of stability is 1 (Theorem 12). These results are summarized in Table 3.

### 1.1.3 COMPUTATION

As to the computation of Nash stable coalition structures, we first show that the class of fractional hedonic games does not possess the finite improvement path property, even when considering best-response dynamics. Namely, such dynamics might have infinite length, even for unweighted bipartite graphs (Theorem 13). This implies that a Nash stable out-

	lower bound	upper bound
star, weighted	$\Omega(n)$ (Theorem 5)	$n - 1$ (Theorem 3)
general topology, weighted		
general topology, unweighted ( <i>main open problem</i> )	2 (Theorem 6)	
triangle free, unweighted	1.0025 (Theorem 11)	18/7 (Theorem 8)
bipartite, unweighted		1.0294 (Theorem 10)
trees, unweighted	1 (Theorem 12)	

Table 3: Results on the Price of Stability.

come cannot be reached by independent selfish agents, unless some kind of coordination or centralized control is enforced. Moreover, we prove that the problems of computing a best Nash stable coalition structure and an optimal one (not necessarily stable) are NP-hard (Theorem 14). On the positive side, we design a polynomial time algorithm which returns a stable outcome approximating the social welfare of the optimal coalition structure by a factor of  $\frac{18}{7}$  (Theorem 15) for unweighted triangle-free graphs and by a factor of 2 for unweighted bipartite graphs (Theorem 16). For unweighted trees, we design a polynomial time algorithm computing an optimal coalition structure that is also Nash stable (Theorem 17). These results are summarized in Table 4.

	complexity	approximation	convergence
general topology, weighted and unweighted	<i>NP-hard</i> (Theorem 14)	<i>open problem</i>	<i>no</i> (Theorem 13)
triangle free, unweighted	<i>open problem</i>	18/7 (Theorem 8)	
bipartite, unweighted		2 (Theorem 16)	
trees, unweighted	P (Theorem 17)	1 (Theorem 17)	<i>open problem</i>

Table 4: Results on the computation of Nash stable coalition structures. The *complexity* column refers to the hardness of computing best-quality Nash stable and optimal (non necessarily stable) coalition structures. The *convergence* column refers to the convergence of best-response dynamics.

## 1.2 Related Work

Before discussing related work concerning hedonic games, we describe the state-of-art of the more general Coalition Structure Generation (CSG) problem. Concerning the general CSG, dynamic programming is one of the several approaches used to solve the problem. To date, one of the most efficient dynamic programming algorithm has been proposed by Rahwan and Jennings (2008), and returns an optimal solution in time  $O(3^n)$ . A number of anytime algorithms (i.e., algorithms returning solutions of monotonically improving quality at any time during the execution), as well as heuristics (with no guarantee on the quality of the returned solution) have been developed for CSG (Rahwan et al., 2012; Rahwan, Ramchurn, Jennings, & Giovannucci, 2009; Sandholm, Larson, Andersson, Shehory, & Tohmé, 1999);

also greedy algorithms have been developed (Shehory & Kraus, 1998). In CSG, since the number of possible coalitions and coalition structures is exponential, the mere specification of the input with all the corresponding values is already intractable. Therefore, researchers have focused on suitable subclasses allowing succinct descriptions. A widely studied setting, introduced by Deng and Papadimitriou (1994) and also studied in other works (Voice et al., 2012), is the one in which the agents are nodes of a graph, and the value of a coalition is the sum of the weights of the edges between its coalition members. Notice that the optimal coalition structure in this setting corresponds to the one of the additively hedonic games described in more detail below. Bachrach et al. (2013) show that finding an optimal solution is hard even for planar graphs. They also provided algorithms with constant factor approximations for planar, minor-free and bounded degree graphs.

Aziz and de Keijzer (2011) show that when the number of agent types is bounded by a constant (two agents have the same type if they are strategically equivalent) or in many cases in which the game is represented compactly on combinatorial domains, the problem becomes polynomially solvable. Alternative approaches to deal with specific valuations consist in defining a set of rules modeling in a concise way a value function, in order to efficiently solve the CSG problem by applying constraint optimization techniques (Ohta et al., 2009), or assuming that the value of a coalition is given by an optimal solution of a distributed constraint optimization problem among the agents of a coalition (Ueda et al., 2010). The online version of the CSG problem has been recently considered by Flammini, Monaco, Moscardelli, Shalom, and Zaks (2018).

Bachrach, Meir, Jung, and Kohli (2010) consider the variant of the coalitional skill games, where the value of a coalition depends on the tasks its members can achieve. They provide hardness results, showing that also in restricted versions computing the optimal coalition structure is difficult. On the positive side, they also provide a polynomial time algorithm for specific instances with a bounded number of tasks.

Bansal et al. (2004) focus on the following related problem: given a complete graph where each edge is labeled with "+" or "-", finding a coalition structure that maximizes the number of "+" edges within coalitions, plus the number of "-" edges between coalitions (equivalently, minimizes the number of disagreements: the number of "-" edges inside coalitions plus the number of "+" edges between coalitions). These two problems are equivalent at optimality and are shown to be both NP-hard. Regarding approximation results, the authors provide a constant factor approximation for minimizing disagreements, and a PTAS for the related maximization problem.

Hedonic games, where each agent has a complete and transitive preference relation over all possible coalitions she can belong to without any form of externality, have been first formalized by Dreze and Greenberg (1980), who analyze them under a cooperative perspective. The hardness of computing the core, Nash stable set and individually stable solutions under several assumptions is shown by Ballester (2004).

*Additively separable* hedonic games constitute a natural class of hedonic games, that can be succinctly represented by means of a preference graph of the agents. In these games, each agent has a value for any other one, and her utility for being in a coalition is simply the sum of the values she assigns to its members. Properties guaranteeing the existence of core allocations (a core is a coalition structure in which no group of agents has an incentive to form a different coalition) are studied by Banerjee et al. (2001), while Bogomolnaia

and Jackson (2002), besides the core, consider other forms of stability, such as Nash and individual stability. Olsen (2009) proves that the problem of deciding whether a Nash stable outcome exists is NP-complete, as well as the one of deciding the existence of a non-trivial (different from the grand coalition) Nash stable outcome in case of non-negative and symmetric preferences. Bloch and Diamantoudi (2011) investigate non-cooperative coalition formation and identify conditions for the existence of stable outcomes. In a similar way, Apt and Witzel (2009) study how certain proposed rules can transform coalition structures into other ones with specific stability properties. Aziz, Brandt, and Seedig (2011) provide a polynomial time algorithm for determining contractually individually stable solutions and show the hardness of determining whether the core or the strict core are not empty, as well as verifying whether the grand coalition is contractually strict core stable or Pareto optimal.

Fractional hedonic games, another natural and succinctly representable class of hedonic games by means of preference graphs, are introduced by Aziz et al. (2014) from the cooperative perspective. They prove that the core can be empty for general graphs and that it is not empty in some classes of undirected unweighted graphs (that is, graphs with degree at most 2, multipartite complete graphs, bipartite graphs admitting a perfect matching and regular bipartite graphs). Brandl, Brandt, and Strobel (2015) study the existence of either the core and individually stable coalition structures and the computational complexity of the related existence decision problems. Moreover, they show that the problem of understanding whether fractional hedonic games admit Nash stable coalition structures is NP-complete. However, if all weights are non-negative (this setting is called social fractional hedonic games in Peters & Elkind, 2015), the grand coalition is trivially a Nash stable coalition structure, that is, a Nash stable coalition structure always exists. In this paper we show that, even in the unweighted case (i.e., a special case of non-negative weights), the problems of computing a best Nash stable coalition structure and an optimal solution (non necessarily Nash stable) are NP-hard.

Olsen (2012) investigates computational issues and the existence of Nash stable outcomes in the variant of fractional hedonic games in which the utility of agent  $i$  in coalition  $C$  is defined as the total happiness of  $i$  in  $C$  divided by  $|C| - 1$ , that is, the agent herself is not accounted to the population of the coalition structure. Monaco, Moscardelli, and Velaj (2018) consider strong equilibria and core stable outcomes in this setting. Although the difference between the two utility functions might seem “almost” negligible, the sets of Nash stable outcomes they induce on the same graphs can be quite different. In Section 6 we will discuss in detail the relationship between our model and the Olsen’s variant. Aziz, Gaspers, Gudmundsson, Mestre, and Täubig (2015) investigate the computational complexity problem of computing welfare maximizing partitions, according to several notions of welfare, providing harness and approximation results.

Other classes of hedonic games are studied in the literature. In particular, Peters (2016) considers “graphical” hedonic games where agents form the vertices of an undirected graph, and each agent’s utility function only depends on the actions taken by her neighbors (with general value functions). It is proven that, when agent graphs have bounded treewidth and bounded degree, the problem of finding Nash stable outcomes can be efficiently solved. This result is similar to the one shown in this paper for trees (Theorem 17), but for the special case in which the maximum degree of the tree is bounded by a constant. Peters and Elkind (2015) consider several classes of hedonic games and identify simple conditions that are



sufficient for the problem of checking whether a given game admits a stable outcome to be computationally hard. Feldman et al. (2012) characterize Nash stable coalition structures in some interesting subclasses of hedonic games. It is worth noticing that their model is quite different from the one considered in this paper: they do not have an underlying graph, but players lie in a metric space with a distance function modeling their distance or “similarity”. Finally, Nash stable coalition structures are also considered in social distance games (Balliu, Flammini, Melideo, & Olivetti, 2017a), where the utility of an agent depends on the average inverse distance from the other agents belonging to her coalition.

Regarding the efficiency of stable solutions, Kaklamanis, Kanellopoulos, and Papaioannou (2016) (in a follow-up paper of our extended abstracts, Bilò, Fanelli, Flammini, Monaco, & Moscardelli, 2014, 2015, originating this full version), show that the price of stability of fractional hedonic games is at least  $1 + \sqrt{6}/2 \approx 2.224$  for general unweighted graphs, and 1 for unweighted graphs of girth at least 5. They further prove that the price of stability is 1 for the variant of Olsen (2012), still for general unweighted graphs. Feldman et al. (2012) investigate some interesting subclasses of hedonic games (however, as aforementioned, their model is quite different from the one considered in this paper) and provide bounds on the efficiency loss of Nash stable outcomes.

Other stability notions in coalition forming games, such as Pareto stability, have also been investigated (Aziz, Brandt, & Harrenstein, 2013; Balliu, Flammini, & Olivetti, 2017b; Elkind et al., 2016). Concerning these stability notions, Elkind et al. (2016) study the price of Pareto optimality, that is the ratio between the social welfare in a social welfare-maximizing outcome of the game and the one in a worst Pareto optimal solution. They provide lower and upper bounds on the price of Pareto optimality for both additively separable and fractional hedonic games. Moreover, Balliu et al. (2017b) analyze the price of Pareto optimality also in social distance games and provide corresponding bounds.

From a different perspective, strategyproof mechanisms for additively separable hedonic games and fractional hedonic games have been proposed by Flammini, Monaco, and Zhang (2017).

As a concluding remark, most of the literature on multi-agent coalition formation focuses on settings where utilities do not depend on agents who are not in the coalition. Rahwan et al. (2012) consider the coalition structure generation problem for games with externalities, in which the formation of a coalition could influence the formation of other ones. Moreover, Zick, Markakis, and Elkind (2014) study cooperative games in the setting in which coalitions do not constitute a partition of agents, but may also overlap.

### 1.3 Paper Organization

The paper is organized as follows. In Section 2, we formally define fractional hedonic games. The technical contributions of the paper are then presented in Sections 3, 4 and 5, which address, respectively, existence, performance and computability of Nash stable coalition structures. Finally, in Section 6, we summarize our results, compare our model with the one studied by Olsen (2012) and provide some interesting open problems.

## 2. Preliminaries

In this section, we recall some background definitions and notation from graph theory and present the model of fractional hedonic games.

For an integer  $k > 0$ , denote with  $[k]$  the set  $\{1, \dots, k\}$ .

### 2.1 Graph Theory Background

For an undirected edge-weighted graph  $G = (N, E, w)$ , denote with  $n = |N|$  the number of its nodes. Given an edge  $\{u, v\} \in E$ , we use  $w_{u,v}$  as a shorthand for its weight  $w(\{u, v\})$ . Say that  $G$  is unweighted if  $w_{u,v} = 1$  for each  $\{u, v\} \in E$ . Given a set of edges  $X \subseteq E$ , denote with  $W(X) = \sum_{\{u,v\} \in X} w_{u,v}$  the total weight of edges in  $X$ .

For a subset of nodes  $S \subseteq N$ , the subgraph of  $G$  induced by  $S$  is the graph  $G_S = (S, E_S, w_S)$  such that  $E_S = \{\{u, v\} \in E : u, v \in S\}$  and  $w_S$  is the restriction of  $w$  to edges in  $E_S$ . The diameter of  $S$ , denoted as  $d(S)$ , is the diameter of  $G_S$ , that is, the maximum distance in  $G_S$  between any pair of nodes in  $S$ . Denote with  $N_u(S) = \{v \in S : \{u, v\} \in E\}$  the neighborhood of  $u$  in  $G_S$  and with  $E_u(S) = \{\{u, v\} \in E : v \in S\}$  the set of edges incident to  $u$  in  $G_S$ .

For an integer  $k \geq 2$ , a *star graph* (from now on, simply, a *star*) of order  $k$  is a tree with  $k$  nodes and  $k - 1$  leaves. Given a star  $S$ , denote with  $ord(S)$  its order, with  $\ell(S)$  the set of its leaves (so that  $ord(S) = |\ell(S)| + 1$ ), and with  $c(S)$  its center, that is, its unique non-leaf node. For a star  $S$  with  $ord(S) = 2$ , the center is arbitrarily chosen between the two nodes.

A vertex cover of  $G$  is a subset of nodes  $VC \subseteq N$  such that each edge in  $E$  is incident to at least a node in  $VC$ . A minimum vertex cover is a vertex cover of minimum cardinality. An independent set of  $G$  is a subset of nodes  $IS \subseteq N$  such that, for every pair of nodes  $u, v \in IS$ ,  $\{u, v\} \notin E$ . It is obvious that, if  $VC$  is a vertex cover of  $G$ , then  $N \setminus VC$  is an independent set of  $G$ .

As usual in graph theory, we denote by  $K_n$  the *complete graph* with  $n$  vertices, and by  $K_{n,m}$  the *complete bipartite graph* in which the two partitions have  $n$  and  $m$  vertices, respectively.

Finally, we recall the following fundamental theorem showing that a triangle-free graph has at most  $n^2/4$  edges.

**Theorem 1** (Turán, 1941). *Let  $G$  be a  $(K_{r+1})$ -free graph. Then,  $E(G) \leq (1 - \frac{1}{r}) \frac{n^2}{2}$ .*

### 2.2 Fractional Hedonic Games

Given an undirected edge-weighted graph  $G = (N, E, w)$ , the *fractional hedonic game* induced by  $G$ , denoted as  $\mathcal{G}(G)$ , is a game in which each node  $u \in N$  is associated with a selfish agent/player. For this reason, we identify each player with her corresponding node in  $N$ . Each agent chooses to join a certain *coalition* among  $n$  candidate ones: the strategy of player  $i$  is an integer  $j \in [n]$ , meaning that player  $i$  is selecting the  $j$ th candidate coalition. Hence, a strategy profile of the game naturally induces a *coalition structure* (or *outcome*)  $\mathbf{C} = \{C_1, C_2, \dots, C_n\}$ , where, for each  $i \in [n]$ ,  $C_i$  is the set of players choosing the  $i$ th coalition.

We would like to notice that our notation slightly differs from the standard one, usually exploited in the literature for defining hedonic games, in which a game is given by a tuple

$(N, \succsim_1, \dots, \succsim_n)$  where  $\succsim_i$  is a complete and transitive relation representing player  $i$ 's preferences over  $\mathcal{N}_i = \{S \subseteq N : S \ni i\}$ . Under this standard notation, a possible strategy for a player  $i \in [n]$  would be given by a set belonging to  $\mathcal{N}_i$ . We have opted for our notation because in this way all possible strategies (the candidate clusters) are always available to players, where in the standard model only sets in which the other players are currently joining the same cluster could be selected in a given state.

Denote by  $\mathbf{C}(u)$  the coalition chosen by player  $u$  in  $\mathbf{C}$ . Observe that  $\mathbf{C}$  defines a partition of the set of agents/nodes into  $n$  coalitions, i.e.,  $\bigcup_{i \in [n]} C_i = N$  and  $C_i \cap C_j = \emptyset$  for any  $i, j \in [n]$  with  $i \neq j$ . Moreover, since the number of candidate coalitions is equal to the number of agents, some coalition may be empty. Hence, we denote with  $|\mathbf{C}|$  the number of non-empty coalitions in  $\mathbf{C}$ .

A *star coalition structure*  $\mathbf{C}$  is an outcome such that, for each  $i \in [n]$  such that  $C_i \neq \emptyset$ , graph  $G_{C_i}$  is a star. Given a star coalition structure  $\mathbf{C}$ , denote with  $c(\mathbf{C}) = \bigcup_{i \in [n]: C_i \neq \emptyset} \{c(G_{C_i})\}$  the set of centers of all stars in  $\mathbf{C}$ .

Coalitions  $C_i$  and  $C_j$  are adjacent if there exist  $u \in C_i$  and  $v \in C_j$  such that  $\{u, v\} \in E$ . Say that  $u$  is a member of  $C_i$  if  $u \in C_i$ . The payoff (or utility) that agent  $u$  achieves in the strategy profile  $\sigma$ , is the overall weight of the edges incident to node  $u$  in the coalition chosen by  $u$  divided by the number of its nodes; formally,

$$p_u(\sigma) = \frac{W(E_u(\mathbf{C}(u)))}{|\mathbf{C}(u)|}.$$

Each agent chooses the coalition to belong to with the aim of maximizing her payoff.

We observe that, if  $G$  admits an isolated vertex  $u$ , then player  $u$  becomes a dummy player in  $\mathcal{G}(G)$  since her payoff is always equal to zero in any possible outcome. For this reason and without loss of generality, we restrict our attention to only those games played on a graph with no isolated vertices.

### 2.3 Better and Best-Response Dynamics

Given a coalition structure  $\mathbf{C}$ , a player  $u \in N$  and a coalition  $C_i \in \mathbf{C}$ , denote with

$$(\mathbf{C}_{-u}, C_i) = \mathbf{C} \setminus \{\mathbf{C}(u), C_i\} \cup \{\mathbf{C}(u) \setminus \{u\}, C_i \cup \{u\}\}$$

the coalition structure obtained from  $\mathbf{C}$  when player  $u$  changes her strategy/coalition from  $\mathbf{C}(u)$  to  $C_i$ . Strategy  $C_i$  is an *improving deviation* for agent  $u$  in  $\mathbf{C}$  if  $p_u((\mathbf{C}_{-u}, C_i)) > p_u(\mathbf{C})$ ; moreover, it is a *best-response* for agent  $u$  in  $\mathbf{C}$  if  $p_u((\mathbf{C}_{-u}, C_i)) = \max_{j \in [n]} p_u((\mathbf{C}_{-u}, C_j))$ . Denote with  $N_{\text{ID}}(\mathbf{C})$  the set of agents possessing an improving deviation in  $\mathbf{C}$ . We say that agent  $u$  is *stable* in  $\mathbf{C}$  if  $u \notin N_{\text{ID}}(\mathbf{C})$ . In order to avoid cluttered notation, in the following we will write  $p_u(\mathbf{C}_{-u}, C_i)$  instead of  $p_u((\mathbf{C}_{-u}, C_i))$ .

A *better-response dynamics* is a sequence of improving deviations, while a *best-response dynamics* is a better-response dynamics in which each improving deviation is also a best-response. A game has the *finite improvement path property* if it does not admit a better-response dynamics of infinite length.

### 2.4 Nash Stable Coalition Structures

We shall focus on the following concepts of stable outcomes in fractional hedonic games.

**Definition 1.** A coalition structure  $\mathbf{C}$  is **Nash stable** if  $N_{\text{ID}}(\mathbf{C}) = \emptyset$ , that is, if all agents are stable in  $\mathbf{C}$ .

We denote with  $\text{NE}(\mathcal{G}(G))$  the set of Nash stable coalition structures of  $\mathcal{G}(G)$ . Clearly, a game possessing the finite improvement path property always admits a Nash stable coalition structure.

**Definition 2.** A coalition structure  $\mathbf{C}$  is  **$k$ -Strongly Nash stable** if, for each coalition structure  $\mathbf{C}'$  obtained from  $\mathbf{C}$  when at most  $k$  agents jointly change their strategies (not necessarily selecting the same candidate coalition),  $p_u(\mathbf{C}) \geq p_u(\mathbf{C}')$  for some  $u$  belonging to the set of deviating agents, that is, after the joint collective deviation, there always exists an agent in the set of deviators who does not improve her utility.

By definition, a 1-Strongly Nash stable coalition structure is also Nash stable and, for each  $k > 1$ , each  $k$ -Strongly Nash stable coalition structure is also  $(k - 1)$ -Strongly Nash stable. A **Strongly Nash stable coalition structure** is an  $n$ -Strongly Nash stable coalition structure; that is, a coalition structure which is resilient to the joint deviation of any possible subset of agents. We denote with  $\text{SNE}_k(\mathcal{G}(G))$  the set of  $k$ -Strongly Nash stable coalition structures of  $\mathcal{G}(G)$ . By definition,  $\text{SNE}_1(\mathcal{G}(G)) = \text{NE}(\mathcal{G}(G))$ .

## 2.5 Price of Anarchy and Price of Stability

Define the *social welfare*  $\text{SW}(\mathbf{C})$  of a coalition structure  $\mathbf{C}$  as the sum of the agents' payoffs, so that  $\text{SW}(\mathbf{C}) = \sum_{u \in N} p_u(\mathbf{C})$ . We slightly overload the notation by denoting with  $\text{SW}(C_i) = \sum_{u \in C_i} p_u(\mathbf{C})$  the contribution of coalition  $C_i \in \mathbf{C}$  to the social welfare of  $\mathbf{C}$ ; thus,  $\text{SW}(\mathbf{C}) = \sum_{i \in [n]} \text{SW}(C_i)$ .

It is easy to see that the following property, providing a simple formula for computing the social welfare of a given coalition structure, holds:

**Property 1.** For a coalition  $C$ ,  $\text{SW}(C) = \frac{2W(E_C)}{|C|}$ .

In particular, for games played on unweighted graphs, Property 1 states that the contribution of each coalition to the social welfare of a coalition structure is given by twice the number of intra-coalition edges divided by the cardinality of the coalition. Moreover, if  $G_{C_i}$  is an unweighted (non-empty) tree,  $\text{SW}(C_i) = \frac{2(|C_i|-1)}{|C_i|}$ .

Given a game  $\mathcal{G}(G)$ , an optimal coalition structure, also called *social optimum*, is a coalition structure maximizing the social welfare. We denote with  $\mathbf{C}^*$  a social optimum for  $\mathcal{G}(G)$ . A coalition structure  $\mathbf{C}$  is *connected* if  $G_{C_i}$  is connected, for every  $i \in [n]$ . It is easy to see that a social optimum is always connected.

**Definition 3.** For an integer  $k \in [n]$ , let  $\mathcal{G}(G)$  be a fractional hedonic game such that  $\text{SNE}_k(\mathcal{G}(G)) \neq \emptyset$ . The  **$k$ -strong price of anarchy** of  $\mathcal{G}(G)$ , denoted as  $\text{PoA}_k(\mathcal{G}(G))$ , is the worst-case ratio between the social welfare of a social optimum and the social welfare of a  $k$ -Strongly Nash stable coalition structure, that is,  $\text{PoA}_k(\mathcal{G}(G)) = \max_{\mathbf{C} \in \text{SNE}_k(\mathcal{G}(G))} \frac{\text{SW}(\mathbf{C}^*)}{\text{SW}(\mathbf{C})}$ . The  **$k$ -strong price of stability** of  $\mathcal{G}(G)$ , denoted as  $\text{PoS}_k(\mathcal{G}(G))$ , is the best-case ratio between the social welfare of a social optimum and the social welfare of a  $k$ -Strongly Nash stable coalition structure, that is,  $\text{PoS}_k(\mathcal{G}(G)) = \min_{\mathbf{C} \in \text{SNE}_k(\mathcal{G}(G))} \frac{\text{SW}(\mathbf{C}^*)}{\text{SW}(\mathbf{C})}$ .

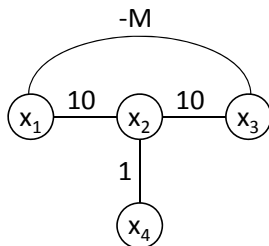

Figure 1: A graph with negative edge weights yielding a fractional hedonic game with no Nash stable coalition structures.

We simply use the terms price of anarchy and price of stability, and remove the subscript  $k$  from the notation, when  $k = 1$ . Note that, since for each game  $\mathcal{G}(G)$  and index  $k \geq 1$ ,  $\text{SNE}_k(\mathcal{G}(G)) \subseteq \text{SNE}_1(\mathcal{G}(G))$ , we can claim the following observation:

**Observation 1.** *For any graph  $G$  and index  $k \geq 1$ ,  $\text{PoS}(\mathcal{G}(G)) \leq \text{PoA}_k(\mathcal{G}(G))$ .*

### 3. Existence of Nash Stable Coalition Structures

In this section, we show results related to the existence of  $k$ -Strongly Nash stable coalition structures.

Observation 2 tells us that Nash stable coalition structures are not guaranteed to exist if negative edge weights are allowed (recall that a 1-Strongly Nash stable coalition structure is, by definition, a Nash stable coalition structure). On the other hand, if the edge weights are restricted to be non-negative, the existence of  $k$ -Strongly Nash stable coalition structures is guaranteed only for  $k = 1$ , as stated by Observation 3 and Theorem 2.

**Observation 2.** *There exists a graph  $G$  containing edges with negative weights such that  $\text{NE}(\mathcal{G}(G)) = \emptyset$ .*

*Proof.* Consider the graph depicted in Figure 1 and fix a Nash stable coalition structure  $\mathbf{C}$ . It is easy to see that, for  $-M$  small enough,  $\mathbf{C}(x_1) \neq \mathbf{C}(x_3)$  since, otherwise,  $p_{x_1}(\mathbf{C}) < 0$  and  $x_1$  would be better off by deviating to an empty cluster. By contrast,  $\mathbf{C}(x_4) = \mathbf{C}(x_2)$ , since, otherwise,  $p_{x_4}(\mathbf{C}) = 0$  and  $x_4$  would be better off by deviating to  $\mathbf{C}(x_2)$ . Now, if  $\mathbf{C}(x_2) = \{x_2, x_4\}$ , then  $p_{x_1}(\mathbf{C}) = 0$  and  $x_1$  would be better off by deviating to  $\mathbf{C}(x_2)$ . If  $\mathbf{C}(x_2) \supset \{x_2, x_4\}$ , then, since  $\mathbf{C}(x_1) \neq \mathbf{C}(x_3)$ , it must be  $|\mathbf{C}(x_2)| = 3$  and there exists a coalition  $C_i$  containing exactly one between the two agents  $x_1$  and  $x_3$ . It follows that  $x_2$  would be better off by deviating to coalition  $C_i$ , as  $p_{x_2}(\mathbf{C}) = 11/3 < p_{x_2}(\mathbf{C}_{-x_2}, C_i) = 5$ . Since all possibilities for  $\mathbf{C}(x_2)$  have been considered and each of them leads to a contradiction, it follows that a Nash stable coalition structure cannot exist.  $\square$

For a fixed graph  $G$ , denote with  $\widehat{\mathbf{C}}$  a coalition structure for  $\mathcal{G}(G)$  in which all agents choose the same coalition (*basic stable outcome*). It is easy to see that a basic stable outcome is Nash stable.

**Observation 3.** For any weighted graph  $G$  with non-negative edge weights,  $\widehat{\mathbf{C}} \in \text{NE}(\mathcal{G}(G))$ .

*Proof.* Since  $G$  has non-negative edge weights, it follows that  $p_u(\widehat{\mathbf{C}}) \geq 0$  for each  $u \in N$ . If an agent deviates to a different (empty) coalition, she gets a payoff equal to zero. Hence,  $\widehat{\mathbf{C}}$  is a Nash stable coalition structure.  $\square$

In order to complete the picture, the next theorem, whose proof is deferred to Appendix A, shows that  $k$ -Strongly Nash stable coalition structures are not guaranteed to exist for  $k > 1$ , even for games played on unweighted graphs.

**Theorem 2.** There exists an unweighted graph  $G$  such that  $\text{SNE}_2(\mathcal{G}(G)) = \emptyset$ .

#### 4. Efficiency of Nash Stable Coalition Structures

In this section, we focus on the efficiency of Nash stable coalition structures. We start by showing a useful lemma relating the social welfare of social optimum for  $\mathcal{G}(G)$  to the cardinality of a minimum vertex cover for  $G$ , when  $G$  is unweighted.

**Lemma 1.** For an unweighted graph  $G = (N, E)$  denote with  $VC$  a minimum vertex cover for  $G$ . Then,  $\frac{\text{SW}(\mathbf{C}^*)}{|VC|} < 2$ .

*Proof.* Define  $\overline{VC} = N \setminus VC$ . Fix a social optimum  $\mathbf{C}^*$  for game  $\mathcal{G}(G)$  and let  $C_i^*$  be a coalition of  $\mathbf{C}^*$ . Partition the nodes of  $C_i^*$  in two sets:  $X_i^{VC} = C_i^* \cap VC$  and  $X_i^{\overline{VC}} = C_i^* \cap \overline{VC}$ . We distinguish between two cases:

- $X_i^{VC} = \emptyset$ ; it follows that  $C_i^* \subseteq \overline{VC}$ . Therefore, since  $\overline{VC}$  is an independent set for  $G$ ,  $\text{SW}(C_i^*) = 0$ .
- $X_i^{VC} \neq \emptyset$ ; in this case the total number of edges in  $C_i^*$  is at most  $|X_i^{VC}| \cdot |X_i^{\overline{VC}}| + \frac{1}{2}|X_i^{VC}|^2$ .

By Property 1, it follows that the contribution of coalition  $C_i^*$  to  $\text{SW}(\mathbf{C}^*)$  is

$$\text{SW}(C_i^*) \leq 2 \frac{|X_i^{VC}| \cdot |X_i^{\overline{VC}}| + \frac{1}{2}|X_i^{VC}|^2}{|X_i^{VC}| + |X_i^{\overline{VC}}|} = 2|X_i^{VC}| \frac{|X_i^{\overline{VC}}| + \frac{1}{2}|X_i^{VC}|}{|X_i^{VC}| + |X_i^{\overline{VC}}|}.$$

Dividing by  $|X_i^{VC}|$  we obtain  $\frac{\text{SW}(C_i^*)}{|X_i^{VC}|} \leq 2 \frac{|X_i^{\overline{VC}}| + \frac{1}{2}|X_i^{VC}|}{|X_i^{VC}| + |X_i^{\overline{VC}}|} < 2$ .

By summing over all indices  $i \in [n]$ , we obtain

$$\frac{\text{SW}(\mathbf{C}^*)}{|VC|} = \frac{\sum_{i \in [n]: X_i^{VC} \neq \emptyset} \text{SW}(C_i^*)}{|VC|} = \frac{\sum_{i \in [n]: X_i^{VC} \neq \emptyset} \text{SW}(C_i^*)}{\sum_{i \in [n]: X_i^{VC} \neq \emptyset} |X_i^{VC}|} \leq \max_{i \in [n]: X_i^{VC} \neq \emptyset} \frac{\text{SW}(C_i^*)}{|X_i^{VC}|} < 2.$$

$\square$

We now characterize the efficiency of Nash stable coalition structures in fractional hedonic games played on general graphs with non-negative edge weights. In the next two theorems, we show that the price of anarchy is upper bounded by  $n - 1$  and that this bound is asymptotically tight even for games played on unweighted trees.

**Theorem 3.** *For any weighted graph with non-negative edge weights  $G$ ,  $\text{PoA}(\mathcal{G}(G)) \leq n-1$ .*

*Proof.* Fix a weighted graph with non-negative edge weights  $G = (V, E, w)$  and, for any  $u \in N$ , define  $W_u = \max_{v \in N} \{w_{u,v}\}$ . For any Nash stable coalition structure  $\mathbf{C}$  and agent  $u \in N$ ,  $p_u(\mathbf{C}) \geq \frac{W_u}{n}$ , which implies  $\text{SW}(\mathbf{C}) \geq \frac{1}{n} \sum_{u \in N} W_u$ . On the other hand, a social optimum  $\mathbf{C}^*$  satisfies  $p_u(\mathbf{C}^*) \leq \frac{n-1}{n} W_u$  for any  $u \in N$ , so that  $\text{SW}(\mathbf{C}^*) \leq \frac{n-1}{n} \sum_{u \in N} W_u$ . Hence, it follows that  $\text{PoA}(\mathcal{G}(G)) \leq n-1$ .  $\square$

**Theorem 4.** *For any integer  $n \geq 2$ , there exists an unweighted path  $G_n$  such that  $\text{PoA}(\mathcal{G}(G_n)) = \Omega(n)$ .*

*Proof.* Let  $G_n = (N_n, E_n)$  be the unweighted graph defined as follows:  $N_n = \{v_i : i \in [n]\}$  and  $E_n = \{\{v_i, v_{i+1}\} : i \in [n-1]\}$ , that is,  $G_n$  is an  $n$ -node simple path. When  $n$  is even, then, since  $G_n$  admits a perfect matching,  $\text{SW}(\mathbf{C}^*) \geq \frac{n}{2}$ , while, when  $n$  is odd,  $\text{SW}(\mathbf{C}^*) \geq \frac{n-1}{2} + \frac{1}{3}$ . On the other hand,  $\text{SW}(\hat{\mathbf{C}}) = \frac{2(n-1)}{n}$  for any value of  $n$ . Hence, the claim follows.  $\square$

So far, we have obtained asymptotically matching bounds for the price of anarchy: On the one hand, the upper bound holds for any weighted graph and, on the other hand, the lower bound holds for an unweighted graph with a very basic topology (i.e., a path).

In the remainder of this section we focus on the price of stability of fractional hedonic games. In particular, we first show that it can grow asymptotically with the number of agents, even for games played on weighted stars. This result, together with the upper bound of  $n-1$  for the price of anarchy given in Theorem 3, asymptotically characterizes the price of stability for games played on general graphs with non-negative edge weights.

**Theorem 5.** *For any integer  $n \geq 2$ , there exists a weighted star  $G_n$  such that  $\text{PoS}(\mathcal{G}(G_n)) = \Omega(n)$ .*

*Proof.* Let  $G_n = (N_n, E_n, w_n)$  be the weighted graph defined as follows:  $N_n = \{v_i : i \in [n]\}$ ,  $E_n = \{\{v_i, v_n\} : i \in [n-1]\}$ ,  $w_{i,n} = 1$  for each  $i \in [n-1]$ , and  $w_{n-1,n} = W \gg n$ , that is,  $G_n$  is a star of order  $n$  centered at  $v_n$ . Note that, for every value of  $n$ ,  $\hat{\mathbf{C}}$  is the unique Nash stable coalition structure of  $\mathcal{G}(G_n)$  and  $\text{SW}(\hat{\mathbf{C}}) = \frac{2(W+n-2)}{n}$ . On the other hand, since the coalition structure in which only  $v_{n-1}$  and  $v_n$  are in the same coalition yields a social welfare of  $W$ , it follows that  $\text{PoS}(\mathcal{G}(G_n)) \geq \frac{2Wn}{2(W+n-2)} = \Omega(n)$  for a sufficiently high value of  $W$ .  $\square$

This negative result rules out the chance of obtaining good bounds even on the price of stability for games played on weighted graphs. Thus, in the following, we shall focus on determining better bounds to the price of stability of games played on unweighted graphs. In Theorem 6, we give a lower bound of 2 to the price of stability.

**Theorem 6.** *For any  $\epsilon > 0$ , there exists an unweighted graph  $G_\epsilon$  such that  $\text{PoS}(\mathcal{G}(G_\epsilon)) > 2 - \epsilon$ .*

*Proof.* For any positive integer  $h$ , define the unweighted graph  $G_h = (N_h, E_h)$  as follows:  $N_h = X_h \cup Y_h$ , with  $X_h = \{x_1, \dots, x_{h+2}\}$ ,  $Y_h = \{y_1, \dots, y_h\}$ , and  $E_h = \{\{x_i, x_j\} : i, j \in [h+2], i \neq j\} \cup \{\{x_i, y_i\} : i \in [h]\}$ . Intuitively,  $G_h$  has  $2h+2$  nodes, where the  $h+2$  nodes

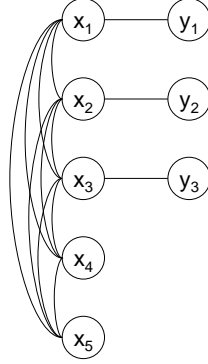

Figure 2: The unweighted graph  $G_3$  exploited in the proof of Theorem 6.

in  $X_h$  form a clique and each of the  $h$  nodes in  $Y_h$  is a *leaf node*. For each  $i \in [h]$ ,  $x_i$  is the *partner node* of leaf node  $y_i$ . Finally, nodes  $x_{h+1}$  and  $x_{h+2}$  are the *special nodes*. See Figure 2 for an example of  $G_h$  with  $h = 3$ .

Our aim is to show that, for each value of  $h$ ,  $\text{NE}(\mathcal{G}(G_h)) = \{\widehat{\mathbf{C}}\}$ , that is,  $\mathcal{G}(G_h)$  has a unique Nash stable coalition structure. We prove this claim by showing a sequence of properties that have to be satisfied by any Nash stable coalition structure for  $\mathcal{G}(G_h)$ . The first of these properties is quite intuitive and states that, in any Nash stable coalition structure for  $\mathcal{G}(G_h)$ , each leaf node has to be in the same coalition of its partner node.

**Property 2.** For any  $\mathbf{C} \in \text{NE}(\mathcal{G}(G_h))$  and  $i \in [h]$ ,  $\mathbf{C}(x_i) = \mathbf{C}(y_i)$ .

In order to prove Property 2, assume, for the sake of contradiction, that there exists a Nash stable coalition structure  $\mathbf{C}$  such that  $\mathbf{C}(x_i) \neq \mathbf{C}(y_i)$  for some  $i \in [h]$ . Then,  $p_{y_i}(\mathbf{C}) = 0$ , while  $p_{y_i}(\mathbf{C}_{-y_i}, \mathbf{C}(x_i)) > 0$  which contradict the fact that  $\mathbf{C}$  is a Nash stable coalition structure.

We continue by showing that, in any Nash stable coalition structure of  $\mathcal{G}(G_h)$ , the two special nodes have to be in the same coalition.

**Property 3.** For any  $\mathbf{C} \in \text{NE}(\mathcal{G}(G_h))$ ,  $\mathbf{C}(x_{h+1}) = \mathbf{C}(x_{h+2})$ .

In order to prove Property 3, assume, for the sake of contradiction, that there exists a Nash stable coalition structure  $\mathbf{C}$  such that  $\mathbf{C}(x_{h+1}) \neq \mathbf{C}(x_{h+2})$ , that is, there are two different coalitions  $C_i$  and  $C_j$  in  $\mathbf{C}$  such that  $x_{h+1} \in C_i$  and  $x_{h+2} \in C_j$ . For each  $k \in [n]$ , define  $n_k = |C_k \cap X_h|$ , hence, by Property 2, it follows that  $|C_i| = 2n_i - 1$  and  $|C_j| = 2n_j - 1$ . Thus,  $p_{x_{h+1}}(\mathbf{C}) = \frac{n_i - 1}{2n_i - 1} < \frac{1}{2}$ , while  $p_{x_{h+1}}(\mathbf{C}_{-x_{h+1}}, C_j) = \frac{n_j}{2n_j} = \frac{1}{2}$ , thus contradicting the hypothesis that  $\mathbf{C}$  is a Nash stable coalition structure.

We can now proceed to show that  $\widehat{\mathbf{C}}$  is the unique Nash stable coalition structure for  $\mathcal{G}(G_h)$ . Assume, for the sake of contradiction, that there exists another Nash stable coalition structure  $\mathbf{C} \neq \widehat{\mathbf{C}}$  for  $\mathcal{G}(G_h)$ . By Properties 2 and 3, there must exist an index  $i \in [h]$ , such that  $\mathbf{C}(x_i) \neq \mathbf{C}(x_{h+1})$ . By Properties 1 and 2 and by the fact that  $\mathbf{C}(x_i)$  does not contain any special node,  $p_{x_i}(\mathbf{C}) = \frac{|\mathbf{C}(x_i)|}{2|\mathbf{C}(x_i)|} = \frac{1}{2}$ . By Properties 1 and 2 and by the fact that  $\mathbf{C}(x_{h+1})$



contains both special nodes,  $p_{x_i}(\mathbf{C}_{-x_i}, \mathbf{C}(x_{h+1})) = \frac{|\mathbf{C}(x_{h+1})|+2}{2(|\mathbf{C}(x_{h+1})|+1)} > \frac{1}{2}$ , thus contradicting the hypothesis that  $\mathbf{C}$  is a Nash stable coalition structure. Hence,  $\widehat{\mathbf{C}}$  is the unique Nash stable coalition structure for  $\mathcal{G}(G_h)$ .

Clearly,  $\text{SW}(\widehat{\mathbf{C}}) = \frac{(h+1)(h+2)+2h}{2(h+1)} < \frac{h+4}{2}$ . Moreover,  $\text{SW}(\mathbf{C}^*) \geq h+1$ , since  $G_h$  admits a perfect matching. Hence, for each positive integer  $h$ ,  $\text{PoS}(\mathcal{G}(G_h)) \geq 2 - \Theta(1/h)$ . By taking the limit for  $h$  going to infinity, the claim follows.  $\square$

Determining better upper bounds on the price of stability in the setting of unweighted graphs remains a challenging task. To this aim, in Theorem 7, we show a constant upper bound on the price of stability for all games admitting 2-Strongly Nash stable coalition structures. Anyway, 2-Strongly Nash stable coalition structures are not always guaranteed to exist, as stated by Theorem 2.

**Theorem 7.** *For any unweighted graph  $G$  such that  $\text{NSC}_2(\mathcal{G}(G)) \neq \emptyset$ ,  $\text{PoS}(\mathcal{G}(G)) \leq 4$ .*

*Proof.* We show that, under the hypothesis of the theorem,  $\text{PoA}_2(\mathcal{G}(G)) \leq 4$  which, by Observation 1, yields the claim. To this aim, fix a 2-Strongly Nash stable coalition structure  $\mathbf{C}$  and let  $N^- = \{u \in N : p_u(\mathbf{C}) < \frac{1}{2}\}$  be the set of agents getting a payoff strictly smaller than  $\frac{1}{2}$  in  $\mathbf{C}$  and  $N^+ = N \setminus N^-$ . We show that  $N^-$  is an independent set of  $G$ . Assume, by way of contradiction, that there exists an edge  $\{u, v\} \in E$  such that  $u, v \in N^-$ . In this case,  $u$  and  $v$  can jointly deviate to a new coalition and obtain both a payoff of  $\frac{1}{2}$ , thus contradicting the fact that  $\mathbf{C} \in \text{NSC}_2(\mathcal{G}(G))$ . Hence, we get that  $N^+$  is a vertex cover of  $G$ . By using Lemma 1, we obtain  $\text{SW}(\mathbf{C}^*) < 2|N^+|$  which, together with  $\text{SW}(\mathbf{C}) \geq \frac{|N^+|}{2}$ , yields the claim.  $\square$

In order to attack the problem of understanding the exact value of the price of stability for games played on general (unweighted) graphs, in the following subsections we focus on some specific graph topologies:

- In Subsection 4.1, we show that, if we deal with triangle-free graphs, the upper bound to the price of stability becomes constant. This means that removing cycles of length 3 is sufficient to obtain a constant upper bound.
- In Subsection 4.2, we show that, for the interesting case of bipartite graphs<sup>1</sup>, the price of stability is very close to 1. A lower bound greater than 1 complements the result, showing that bipartite graphs are not sufficient in order to guarantee the stability of some social optimum.
- Finally, in Subsection 4.3, it is shown that there exists a social optimum in trees that is also Nash stable, i.e., the price of stability is 1 for games played on acyclic graphs.

#### 4.1 Unweighted Triangle-free Graphs

In this subsection, we focus on games played on triangle-free unweighted graphs and provide an algorithm computing a Nash stable coalition structure approximating the optimal social

---

1. Recall that, as outlined in the Introduction, bipartite graphs are a very interesting class of graphs in the context of social sciences.

welfare up to  $18/7 \approx 2.5724$ , thus proving an upper bound on the price of stability for games played on this graph topology. This upper bound is complemented by the lower bound of Theorem 11 presented in Subsection 4.2, holding for the restricted case of bipartite graphs and showing that the price of stability is strictly greater than 1.

Recall that, for a star coalition structure  $\mathbf{C}$ ,  $c(\mathbf{C}) = \bigcup_{i \in [n]: C_i \neq \emptyset} \{c(G_{C_i})\}$  denotes the set of centers of all stars in  $\mathbf{C}$ .

Given an unweighted triangle-free graph, Algorithm 1, described below, outputs a Nash stable coalition structure for  $\mathcal{G}(G)$  as follows. It first computes a maximum matching  $M$  for  $G$ . Then, with the for-cycle at Lines 5–10, it creates  $|M|$  coalitions by assigning each pair of nodes corresponding to an edge of  $M$  to a different coalition. All nodes processed during this phase are included in the set of nodes denoted as *Covered*. Then, with the for-cycle at Lines 11–14, the algorithm assigns each node  $u \notin \text{Covered}$  to a coalition containing a node  $v \in \text{Covered}$  such that  $\{u, v\} \in E$ . We shall show in Lemma 2 that this type of assignment can be always carried out so that, at the end of Line 14,  $\mathbf{C}$  forms a star coalition structure for  $\mathcal{G}(G)$ . Finally, the while-cycle at Lines 17–21 defines a better-response dynamics  $\langle (\mathbf{C}^k)_{k \geq 0} \rangle$  starting from  $\mathbf{C}^0 = \mathbf{C}$  in which, for each  $k \geq 0$ , the node with the minimum payoff among those possessing an improving deviation in  $\mathbf{C}^k$  and not belonging to  $c(\mathbf{C}^k)$  is allowed to change her strategic choice. In Lemma 3, we shall show that  $\mathbf{C}^k$  is a star coalition structure for each  $k \geq 0$  so that set  $c(\mathbf{C}^k)$  is always well-defined, while in Theorem 9 we shall prove that the dynamics converges to a Nash stable coalition structure.

The main result of this subsection is given by the following theorem.

**Theorem 8.** *For any unweighted triangle-free graph  $G$ ,  $\text{PoS}(\mathcal{G}(G)) \leq \frac{18}{7}$ .*

We prove Theorem 8 by estimating the performance guarantee of the coalition structure output by Algorithm 1. Therefore, we first need to show that Algorithm 1 returns a Nash stable coalition structure. To prove this claim, we make use of the following two lemmas, whose proofs are in Appendix B: Lemma 2 shows that the family of subsets of nodes  $\mathbf{C}$  computed at the end of Line 14 is a star coalition structure for  $\mathcal{G}(G)$ , while Lemma 3 shows that, for each coalition structure  $\mathbf{C}^k$ , generated by the better-response dynamics implemented by Lines 17–21 of Algorithm 1,  $\mathbf{C}^k$  is also a star coalition structure for  $\mathcal{G}(G)$ .

**Lemma 2.** *The family of subsets of nodes  $\mathbf{C}$  computed at the end of Line 14 of Algorithm 1 is a star coalition structure for  $\mathcal{G}(G)$ .*

**Lemma 3.** *For each  $k \geq 0$ ,  $\mathbf{C}^k$  is a star coalition structure for  $\mathcal{G}(G)$ .*

We are now ready to prove that Algorithm 1 outputs a Nash stable coalition structure.

**Theorem 9.** *Given an unweighted triangle-free graph  $G$ , Algorithm 1 computes a Nash stable coalition structure  $\tilde{\mathbf{C}}$  for  $\mathcal{G}(G)$ .*

*Proof.* By Lemma 3, we know that, for each  $k \geq 0$ ,  $\mathbf{C}^k$  is a star coalition structure for  $\mathcal{G}(G)$ .

First of all, we show that the better-response dynamics generated by the while-cycle at lines 17–21 of Algorithm 1 terminates after a finite number of iterations (later on, within the proof of Theorem 15, we shall even show that the number of iterations is even polynomial in the dimensions of  $\mathcal{G}(G)$ ). Towards this end, it is not difficult to see that, as for each  $k \geq 0$

---

**Algorithm 1**

---

```

1:  $\mathbf{C} = (C_1, \dots, C_n)$  with  $C_i = \emptyset$  for each  $i \in [n]$ 
2: Compute a maximum matching  $M$  for  $G$ 
3:  $i \leftarrow 1$ 
4:  $Covered \leftarrow \emptyset$ 
5: for each  $\{u, v\} \in M$  do
6:    $\mathbf{C}(u) \leftarrow C_i$ 
7:    $\mathbf{C}(v) \leftarrow C_i$ 
8:    $Covered \leftarrow Covered \cup \{u, v\}$ 
9:    $i \leftarrow i + 1$ 
10: end for
11: for each  $u \notin Covered$  do
12:   Choose  $v \in Covered$  such that  $\{u, v\} \in E$ 
13:    $\mathbf{C}(u) \leftarrow \mathbf{C}(v)$ 
14: end for
15:  $k \leftarrow 0$ 
16:  $\mathbf{C}^k \leftarrow \mathbf{C}$ 
17: while  $N_{ID}(\mathbf{C}^k) \setminus c(\mathbf{C}^k) \neq \emptyset$  do
18:    $u = \arg \min_{v \in N_{ID}(\mathbf{C}^k) \setminus c(\mathbf{C}^k)} \{p_v(\mathbf{C}^k)\}$ 
19:    $\mathbf{C}^{k+1} \leftarrow (\mathbf{C}^k_{-u}, C_j)$  with strategy  $C_j$  being an improving deviation for  $u$  in  $\mathbf{C}^k$ 
20:    $k \leftarrow k + 1$ 
21: end while
22:  $\tilde{\mathbf{C}} \leftarrow \mathbf{C}^k$ 
23: return  $\tilde{\mathbf{C}}$ 

```

---

$\mathbf{C}^k$  is a star coalition structure for  $\mathcal{G}(G)$ , the vector obtained by listing all players' payoffs in non-decreasing order always increases lexicographically after each improving deviation.

Now, since at the end of the while-cycle each agent  $u \notin c(\tilde{\mathbf{C}})$  is stable in  $\tilde{\mathbf{C}}$  by definition, in order to show that  $\tilde{\mathbf{C}}$  is Nash stable, we only need to consider agents belonging to  $c(\tilde{\mathbf{C}})$ . To this aim, assume, by way of contradiction, that there exists an agent  $u \in c(\tilde{\mathbf{C}})$  who can perform an improving deviation by migrating to a coalition  $\tilde{C}_i$ , that is, such that  $p_u(\tilde{\mathbf{C}}) < p_u(\tilde{\mathbf{C}}_{-u}, \tilde{C}_i)$ .

We have  $p_u(\tilde{\mathbf{C}}) = \frac{|\tilde{\mathbf{C}}(u)|-1}{|\tilde{\mathbf{C}}(u)|}$ . Two cases may occur:

1.  $\{u, c(G_{\tilde{C}_i})\} \in E$ . Since  $G$  is triangle-free,  $E_u(\tilde{C}_i \cup \{u\}) = \{u, c(G_{\tilde{C}_i})\}$  which implies

$$p_u(\tilde{\mathbf{C}}_{-u}, \tilde{C}_i) = \frac{1}{|\tilde{C}_i| + 1} < \frac{|\tilde{\mathbf{C}}(u)| - 1}{|\tilde{\mathbf{C}}(u)|} = p_u(\tilde{\mathbf{C}}),$$

where the inequality follows from  $|\tilde{C}_i|, |\tilde{\mathbf{C}}(u)| \geq 2$ . This contradicts the assumption that  $u$  can perform an improving deviation by migrating to  $\tilde{C}_i$ .

2.  $\{u, c(G_{\tilde{C}_i})\} \notin E$ . Let  $1 \leq j \leq |\tilde{C}_i| - 1$  be the number of nodes in  $\tilde{C}_i$  which are adjacent to  $u$  in  $G$ , so that  $p_u(\tilde{\mathbf{C}}_{-u}, \tilde{C}_i) = \frac{j}{|\tilde{C}_i|+1}$ . Note that it cannot be  $j = 0$ ,

because otherwise it would follow  $p_u(\tilde{\mathbf{C}}_{-u}, \tilde{C}_i) = 0$ , thus immediately contradicting  $p_u(\tilde{\mathbf{C}}) < p_u(\tilde{\mathbf{C}}_{-u}, \tilde{C}_i)$ . If  $|\tilde{\mathbf{C}}(u)| \geq |\tilde{C}_i|$ , then

$$p_u(\tilde{\mathbf{C}}_{-u}, \tilde{C}_i) = \frac{j}{|\tilde{C}_i| + 1} \leq \frac{|\tilde{C}_i| - 1}{|\tilde{C}_i| + 1} \leq \frac{|\tilde{\mathbf{C}}(u)| - 1}{|\tilde{\mathbf{C}}(u)| + 1} < \frac{|\tilde{\mathbf{C}}(u)| - 1}{|\tilde{\mathbf{C}}(u)|} = p_u(\tilde{\mathbf{C}}),$$

while, if  $|\tilde{\mathbf{C}}(u)| = |\tilde{C}_i| - 1$ , then

$$p_u(\tilde{\mathbf{C}}_{-u}, \tilde{C}_i) = \frac{j}{|\tilde{C}_i| + 1} \leq \frac{|\tilde{C}_i| - 1}{|\tilde{C}_i| + 1} = \frac{|\tilde{\mathbf{C}}(u)|}{|\tilde{\mathbf{C}}(u)| + 2} \leq \frac{|\tilde{\mathbf{C}}(u)| - 1}{|\tilde{\mathbf{C}}(u)|} = p_u(\tilde{\mathbf{C}}),$$

where the last inequality follows from  $|\tilde{\mathbf{C}}(u)| \geq 2$ . In both cases, we obtain a contradiction to the assumption that  $u$  can perform an improving deviation by migrating to  $\tilde{C}_i$ .

For the leftover case of  $|\tilde{\mathbf{C}}(u)| < |\tilde{C}_i| - 1$ , let  $z$  be a node of  $\tilde{C}_i$  which is adjacent to  $u$  (such a node always exists since  $j \geq 1$ ). Since  $z \neq c(G_{\tilde{C}_j})$ , we have  $p_z(\tilde{\mathbf{C}}) = \frac{1}{|\tilde{C}_i|}$  and  $p_z(\tilde{\mathbf{C}}_{-z}, \tilde{\mathbf{C}}(u)) \geq \frac{1}{|\tilde{\mathbf{C}}(u)| + 1}$ . Since  $|\tilde{\mathbf{C}}(u)| + 1 < |\tilde{C}_i|$ , it follows that  $p_z(\tilde{\mathbf{C}}_{-z}, \tilde{\mathbf{C}}(u)) > p_z(\tilde{\mathbf{C}})$  which contradicts the fact that  $z \notin c(\tilde{\mathbf{C}})$  does not possess any improving deviation in  $\tilde{\mathbf{C}}$ .  $\square$

We now show the approximation guarantee provided by  $\tilde{\mathbf{C}}$ .

**Proof of Theorem 8.** In order to prove the claim, we will show that  $\text{SW}(\mathbf{C}^*) \leq \frac{18}{7} \cdot \text{SW}(\tilde{\mathbf{C}})$ .

Let  $g : N \rightarrow \mathbb{R}_{>0}$  be a function such that, for each  $i \in [n]$ ,

$$\sum_{u \in \tilde{C}_i} g(u) = \sum_{u \in \tilde{C}_i} p_u(\tilde{\mathbf{C}}) = \text{SW}(\tilde{C}_i) = \frac{2|\ell(G_{\tilde{C}_i})|}{|\ell(G_{\tilde{C}_i})| + 1},$$

that is,  $g$  arbitrarily redistributes the social welfare of each star in  $\tilde{\mathbf{C}}$  among its members. By the property of  $g$ , we get

$$\frac{\text{SW}(\mathbf{C}^*)}{\text{SW}(\tilde{\mathbf{C}})} = \frac{\sum_{C \in \mathbf{C}^*} \text{SW}(C)}{\sum_{u \in N} g(u)} = \frac{\sum_{C \in \mathbf{C}^*} \text{SW}(C)}{\sum_{C \in \mathbf{C}^*} \sum_{u \in C} g(u)} \leq \max_{C \in \mathbf{C}^*} \frac{\text{SW}(C)}{\sum_{u \in C} g(u)}.$$

Now, fix a coalition  $C \in \mathbf{C}^*$  and denote with  $f_i$  (resp.  $c_i$ ) the number of nodes in  $C$  which are leaves (resp. centers) of some star of order  $i$  in  $\tilde{\mathbf{C}}$ . Set  $\bar{f}_i = \sum_{j \geq i} f_j$  and  $\bar{c}_i = \sum_{j \geq i} c_j$ .

Since there are no isolated vertices in  $G$ , we have

$$\text{SW}(C) = \frac{2|E(C)|}{f_2 + c_2 + f_3 + c_3 + \bar{f}_4 + \bar{c}_4}.$$

Moreover, we can upper bound the number of edges in  $C$  as follows:

$$|E(C)| \leq \frac{(c_2 + c_3 + \bar{c}_4)^2}{4} + (f_2 + f_3 + \bar{f}_4)(c_3 + \bar{c}_4) + (f_2 + f_3)c_2 + f_2f_3 + \frac{f_2^2}{4},$$

where the first term, accounting for edges between pairs of centers, comes from Theorem 1 and the fact that  $G$  is triangle-free, the second and third terms, accounting for edges between centers and leaves, come from the fact that in  $\tilde{\mathbf{C}}$  there are no edges between centers of stars of order 2 and leaves of stars of order at least 4 (otherwise  $\tilde{\mathbf{C}}$  would not be Nash stable), and the last two terms, accounting for edges between pairs of leaves, come from the fact that in  $\tilde{\mathbf{C}}$  there can be edges only between leaves of stars of order 2 and stars of order 3 or between pairs of leaves of stars of order 2 and, in this latter case, we again exploit the fact that  $G$  is triangle-free in conjunction with Theorem 1.

Let us define the following redistributing function  $g$ .

$$g(u) = \begin{cases} 1/2 & \text{if } \text{ord}(G_{\tilde{\mathbf{C}}(u)}) = 2, \\ 7/9 & \text{if } \text{ord}(G_{\tilde{\mathbf{C}}(u)}) = 3 \text{ and } u = c(G_{\tilde{\mathbf{C}}(u)}), \\ 5/18 & \text{if } \text{ord}(G_{\tilde{\mathbf{C}}(u)}) = 3 \text{ and } u \in \ell(G_{\tilde{\mathbf{C}}(u)}), \\ \frac{2\ell(G_{\tilde{\mathbf{C}}(u)})}{\ell(G_{\tilde{\mathbf{C}}(u)})+1} & \text{if } \text{ord}(G_{\tilde{\mathbf{C}}(u)}) \geq 4 \text{ and } u = c(G_{\tilde{\mathbf{C}}(u)}), \\ 0 & \text{otherwise.} \end{cases}$$

We obtain

$$\sum_{u \in C} g(u) \geq \frac{3}{2}\bar{c}_4 + \frac{7}{9}c_3 + \frac{5}{18}f_3 + \frac{1}{2}(c_2 + f_2).$$

Putting all together, we get

$$\begin{aligned} \frac{\text{SW}(C)}{\sum_{u \in C} g(u)} &\leq \frac{(c_2 + c_3 + \bar{c}_4)^2 + 4(f_2 + f_3 + \bar{f}_4)(c_3 + \bar{c}_4) + 4(f_2 + f_3)c_2 + 4f_2f_3 + f_2^2}{(f_2 + c_2 + f_3 + c_3 + \bar{f}_4 + \bar{c}_4) \left(3\bar{c}_4 + \frac{14}{9}c_3 + \frac{5}{9}f_3 + c_2 + f_2\right)} \\ &\leq \frac{18}{7}, \end{aligned}$$

where the last inequality follows from the fact that, for each monomial  $a$  in the numerator, there exists a correspondent (unique) monomial  $a'$  in the denominator such that  $a/a' \leq 18/7$ .  $\square$

## 4.2 Unweighted Bipartite Graphs

In this subsection, we focus on games played on unweighted bipartite graphs and derive an upper bound on the price of stability that is close to 1. We complement this result by showing that an upper bound of 1 is not possible.

### 4.2.1 UPPER BOUND

Given a generic, but fixed, coalition  $C^* \in \mathbf{C}^*$ , denote with  $V^* = \{v_1^*, \dots, v_p^*\}$  a minimum vertex cover for  $C^*$ .

**Definition 4.** A fractional assignment of leaves (to stars centered at  $V^*$ ) is a function  $f : C^* \setminus V^* \times [p] \rightarrow \mathbb{R}_{>0}$  such that

1.  $\sum_{i \in [p]: \{u, v_i^*\} \in E} f(u, i) = 1$  for each  $u \in C^* \setminus V^*$ ,
2.  $\sum_{u \in C^* \setminus V^*: \{u, v_i^*\} \in E} f(u, i) > 0$  for each  $i \in [p]$ .

We denote with  $\mathcal{F}(V^*)$  the set of all fractional assignments of leaves. Next lemma shows that this set is always non-empty.

**Lemma 4.** For any minimum vertex cover  $V^*$  of  $C^*$ ,  $\mathcal{F}(V^*) \neq \emptyset$ .

*Proof.* The claim directly follows from the proof of Königs's Theorem according to which, given a minimum vertex cover  $V^*$ , it is possible to match every node  $v_i^* \in V^*$  to a distinguished node  $v(i) \in C^* \setminus V^*$  such that  $\{i, v(i)\} \in E$ . Define  $U(V^*) = \bigcup_{i \in [p]} \{v(i)\}$  and  $\bar{U}(V^*) = C^* \setminus (V^* \cup U(V^*))$ . For each node  $u \in \bar{U}(V^*)$  let  $s(u)$  be a generic node in  $V^*$  such that  $\{u, s(u)\} \in E$  (clearly,  $s(u)$  always exists because  $V^*$  is a vertex cover). Now let  $f : C^* \setminus V^* \times [p] \rightarrow \mathbb{R}_{>0}$  be the function such that, for each  $i \in [p]$  and  $u \in U(V^*)$ ,  $f(u, i) = 1$  if and only if  $u = v(i)$  and, for each  $i \in [p]$  and  $u \in \bar{U}(V^*)$ ,  $f(u, i) = 1$  if and only if  $v_i^* = s(u)$ . It is easy to check that  $f$  is a fractional assignment of leaves to stars centered at  $V^*$ .  $\square$

**Definition 5.** The fractional star coalition structure (of  $C^*$  centered at  $V^*$ ) induced by  $f$  is a collection of  $p$  stars  $\mathbf{S}^f = (S_1^f, \dots, S_p^f)$  such that, for each  $i \in [p]$ ,  $c(S_i^f) = v_i^*$  and  $\ell(S_i^f) = \{u \in C^* \setminus V^* : f(u, i) > 0\}$ , where  $f(u, i)$  measures the fractional portion of  $u$  which is meant to belong to  $S_i^f$ . Denote  $x_i = \sum_{u \in \ell(S_i^f)} f(u, i)$ .

We observe that, for each  $i \in [p]$ ,  $S_i^f$  is indeed a star since, by the definition of vertex cover, the set of nodes  $C^* \setminus V^*$  is an independent set of  $C^*$  and, by property 2 in the definition of fractional assignments of leaves, the order of  $S_i^f$  is at least two. Hence, because of Lemma 4, it follows that the set of fractional star coalition structures induced by the set of fractional assignments of leaves  $\mathcal{F}(V^*)$  is non-empty. The social welfare of a fractional star coalition structure  $\mathbf{S}^f$  is defined as  $\text{SW}(\mathbf{S}^f) = \sum_{i \in [p]} \text{SW}(S_i^f)$ , where  $\text{SW}(S_i^f) = \frac{2x_i}{x_i + 1}$ .

Fix a fractional star coalition structure of maximum social welfare  $\mathbf{S}^{f^*}$ . Let  $H = \{x_i : i \in [p]\}$  and  $h = |H|$ . We partition the stars of  $\mathbf{S}^{f^*}$  into  $h$  sets  $A_1, \dots, A_h$  in such a way that  $S_i^{f^*} \in A_j$  if and only if  $x_i$  is the  $j$ th highest value in  $H$ . For each  $i \in [h]$ , define  $L_i = \bigcup_{S_j^{f^*} \in A_i} \ell(S_j^{f^*})$  as the set of leaves of all stars belonging to  $A_i$  and  $K_i = \bigcup_{S_j^{f^*} \in A_i} \{v_j^*\}$  as the set of centers of all stars belonging to  $A_i$  and denote with  $l_i = |L_i|$  and with  $k_i = |K_i|$ . Observe that, by definition, the sets  $K_i$ s are pairwise disjoint, while it is possible that two different sets  $L_i$  and  $L_j$  share some nodes. Anyway, we will show in the sequel that this is not possible.

First of all, we show in the following lemma, whose proof is in Appendix C, that partition  $(A_1, \dots, A_h)$  is such that, for each  $i \in [h]$ , there are no edges connecting a leaf in  $L_i$  to a center in  $K_j$  for each  $j > i$ .

**Lemma 5.** Fix an edge  $\{u, v\} \in E(C^*)$  with  $u \in L_i$  for some  $i \in [h - 1]$ . Then,  $v \notin \bigcup_{j \in [h] \setminus [i]} K_j$ .

As a consequence of Lemma 5, we obtain that the sets  $L_i$ s are pairwise disjoint.

**Lemma 6.** *For each  $i, j \in [h]$  with  $i \neq j$ ,  $L_i \cap L_j = \emptyset$ .*

*Proof.* Assume, by way of contradiction, that there exist two indices  $i, j \in [h]$ , with  $i < j$ , and a node  $u$  such that  $u \in L_i \cap L_j$ . As  $u \in L_j$ , there exists a star in  $A_j$  whose center  $v \in K_j$  satisfies  $\{u, v\} \in E(C^*)$ . Clearly, by definition,  $\{u, v\} \in E(C^*)$ . But, since  $u \in L_i$ ,  $v \in K_j$  and  $i < j$ , we derive a contradiction to Lemma 5.  $\square$

Now we can exploit Lemma 6 to achieve the following additional property satisfied by the partition  $(A_1, \dots, A_h)$ .

**Lemma 7.** *For each  $i \in [h]$ ,  $x_i = \frac{l_i}{k_i}$ .*

*Proof.* Fix an index  $i \in [h]$ . By construction, for each  $S_j^{f^*} \in A_i$ ,  $\sum_{u \in \ell(S_j^{f^*})} f^*(u, j) = x_i$ . Hence, by summing over all stars belonging to  $A_i$ , we obtain

$$\sum_{S_j^{f^*} \in A_i} \sum_{u \in \ell(S_j^{f^*})} f^*(u, j) = k_i x_i. \quad (1)$$

Moreover, because of Lemma 6 and property 1 of fractional assignments of leaves,

$$\sum_{S_j^{f^*} \in A_i} \sum_{u \in \ell(S_j^{f^*})} f^*(u, j) = l_i. \quad (2)$$

By combining equations (1) and (2), we obtain the claim.  $\square$

Next lemma, whose proof is in Appendix C, shows how to suitably round  $\mathbf{S}^{f^*}$  so as to obtain a star coalition structure for  $C^*$  of high social welfare.

**Lemma 8.** *For each  $i \in [h]$ , there exists star coalition structure  $\mathbf{S} = (S_1, \dots, S_{k_i})$  centered at  $K_i$  of the set of nodes  $K_i \cup L_i$  such that  $\sum_{j \in [k_i]} \text{SW}(S_j) = 2 \left( \frac{z_i \lfloor x_i \rfloor}{\lfloor x_i \rfloor + 1} + \frac{(k_i - z_i) \lfloor x_i \rfloor}{\lfloor x_i \rfloor + 1} \right)$  with  $z_i \lfloor x_i \rfloor + (k_i - z_i) \lfloor x_i \rfloor = l_i$  for some  $0 \leq z_i \leq k_i$ .*

By the arbitrariness of  $C^*$ , we can conclude that there exists a star coalition structure  $\mathbf{S}^*$  such that  $\text{SW}(\mathbf{S}^*) = \sum_{i \in [h]} 2 \left( \frac{z_i \lfloor x_i \rfloor}{\lfloor x_i \rfloor + 1} + \frac{(k_i - z_i) \lfloor x_i \rfloor}{\lfloor x_i \rfloor + 1} \right)$  with  $z_i \lfloor x_i \rfloor + (k_i - z_i) \lfloor x_i \rfloor = l_i$  for some  $0 \leq z_i \leq k_i$ . Anyway,  $\mathbf{S}^*$  may not be a Nash stable coalition structure. Next lemma, whose proof is in Appendix C, shows how to obtain a Nash stable coalition structure from  $\mathbf{S}^*$  without worsening its social welfare.

**Lemma 9.** *There exists a Nash stable coalition structure  $\mathbf{C}$  such that  $\text{SW}(\mathbf{C}) \geq \text{SW}(\mathbf{S}^*)$ .*

After having lower bounded the social welfare of a best possible Nash stable coalition structure, we now exploit the properties of the partition  $(A_1, \dots, A_h)$  to obtain an upper bound on the social welfare of  $\mathbf{C}^*$ . First, we show an upper bound on the number of edges in  $C^*$ , for any  $C^* \in \mathbf{C}^*$ .

For each  $i \in [h]$ , define  $k_{\leq i} = \sum_{j \in [i]} k_j$ .

**Lemma 10.**  $|E(C^*)| \leq \sum_{i \in [h]} l_i k_{\leq i}$ .

*Proof.* First note that, because of the fact that  $C^* \setminus V^*$  forms an independent set of  $C^*$ , there cannot be an edge in  $E(C^*)$  connecting two nodes belonging to  $\bigcup_{i \in [h]} L_i$ . Moreover, by Lemma 5, we also know that, for any  $i \in [h-1]$ , there cannot be an edge in  $E(C^*)$  connecting a node in  $L_i$  to a node in  $\bigcup_{j \in [h] \setminus [i]} K_j$ . Hence, each edge  $\{u, v\} \in E(C^*)$  can be of one of the following two types:

1.  $u, v \in \bigcup_{i \in [h]} K_i$ ,
2.  $u \in K_i$  and  $v \in L_j$  for some  $i, j \in [h]$  with  $j \geq i$ .

Let us denote with  $E_1$  (resp.  $E_2$ ) the set of edges of type 1 (resp. 2). Clearly, by the above observations, we have  $|E(C^*)| = |E_1| + |E_2|$ .

Consider now an edge  $\{v_q^*, v_r^*\} \in E_1$  and assume  $S_q^{f^*} \in A_i$  and  $S_r^{f^*} \in A_j$  with  $i \leq j$ . Since  $G$  is triangle-free, the existence of edge  $\{u, v\} \in E(C^*)$  implies the non-existence of the  $|\ell(S_r^{f^*})| \geq 1$  edges of type 2 which can be obtained by connecting  $u$  to each node in  $\ell(S_r^{f^*})$ . By repeating this reasoning for all the edges in  $E_1$ , we obtain that  $|E_1| + |E_2|$  is upper bounded by the maximum number of edges which can potentially belong to  $E_2$  when assuming  $E_1 = \emptyset$ . Hence, by the definition of  $E_2$ , we obtain  $|E(C^*)| \leq |E_1| + |E_2| \leq \sum_{i \in [h]} l_i k_{\leq i}$ .  $\square$

In order to achieve our desired upper bound, we need the following technical lemma, whose proof is in Appendix C.

**Lemma 11.** *Given that  $\frac{l_i}{k_i} \geq \frac{l_{i+1}}{k_{i+1}}$  for any  $i \in [h-1]$ ,*

$$\frac{\sum_{i \in [h]} l_i k_{\leq i}}{\sum_{i \in [h]} (k_i + l_i)} \leq \sum_{i \in [h]} \frac{k_i l_i}{k_i + l_i}.$$

As a direct consequence of Lemmas 10 and 11, we obtain the following corollary.

**Corollary 1.** *For each  $C^* \in \mathbf{C}^*$ ,  $\text{SW}(C^*) \leq \frac{2l_i}{x_i + 1}$ .*

*Proof.* Fix a coalition  $C^* \in \mathbf{C}^*$ . By Lemmas 10 and 11, it follows that  $\text{SW}(C^*) \leq \sum_{i \in [h]} \frac{k_i l_i}{k_i + l_i}$ . The claim follows by dividing both the numerator and the denominator of each term in the summation by  $k_i$  and by applying Lemma 7.  $\square$

We can now conclude by showing the following upper bound on the price of stability of games played on unweighted bipartite graphs.

**Theorem 10.** *For any unweighted bipartite graph  $G$ ,  $\text{PoS}(\mathcal{G}(G)) \leq 6(3 - 2\sqrt{2}) \approx 1.0294$ .*

*Proof.* Fix a bipartite graph  $G$ . By Lemma 9 and Corollary 1, it follows that

$$\text{PoS}(\mathcal{G}(G)) \leq \frac{\sum_{i \in [h]} \frac{l_i}{x_i + 1}}{\sum_{i \in [h]} \left( \frac{z_i \lfloor x_i \rfloor}{\lfloor x_i \rfloor + 1} + \frac{(k_i - z_i) \lceil x_i \rceil}{\lceil x_i \rceil + 1} \right)},$$



where  $z_i \lfloor x_i \rfloor + (k_i - z_i) \lceil x_i \rceil = l_i$  for some integer  $0 \leq z_i \leq k_i$ . Hence, we obtain

$$\text{PoS}(\mathcal{G}(G)) \leq \frac{\sum_{i \in [h]} \left( \frac{z_i \lfloor x_i \rfloor}{x_i + 1} + \frac{(k_i - z_i) \lceil x_i \rceil}{x_i + 1} \right)}{\sum_{i \in [h]} \left( \frac{z_i \lfloor x_i \rfloor}{\lfloor x_i \rfloor + 1} + \frac{(k_i - z_i) \lceil x_i \rceil}{\lceil x_i \rceil + 1} \right)}, \quad (3)$$

where  $z_i \lfloor x_i \rfloor + (k_i - z_i) \lceil x_i \rceil = l_i$  for some integer  $0 \leq z_i \leq k_i$ . Note that the contribution of each term of the summation is maximized when  $x_i$  is not an integer. So assume that, for each  $i \in [h]$ ,  $\lfloor x_i \rfloor = \alpha_i$  and  $\lceil x_i \rceil = \alpha_i + 1$  for some integer  $\alpha_i \geq 1$ . From  $z_i \lfloor x_i \rfloor + (k_i - z_i) \lceil x_i \rceil = l_i = k_i x_i$ , we obtain  $z_i = k_i(\alpha_i + 1 - x_i)$ . By using this equality in (3), we get

$$\text{PoS}(\mathcal{G}(G)) \leq \frac{\sum_{i \in [h]} \frac{\alpha_i(\alpha_i + 1 - x_i) + (\alpha_i + 1)(x_i - \alpha_i)}{x_i + 1}}{\sum_{i \in [h]} \left( \frac{\alpha_i(\alpha_i + 1 - x_i)}{\alpha_i + 1} + \frac{(\alpha_i + 1)(x_i - \alpha_i)}{\alpha_i + 2} \right)}, \quad (4)$$

where, for each  $i \in [h]$ ,  $\alpha_i$  is a positive integer and  $x_i$  is a rational number such that  $\alpha_i < x_i < \alpha_i + 1$ . By using a standard averaging argument in (4), we obtain

$$\begin{aligned} \text{PoS}(\mathcal{G}(G)) &\leq \max_{i \in [h]} \frac{\frac{\alpha_i(\alpha_i + 1 - x_i) + (\alpha_i + 1)(x_i - \alpha_i)}{x_i + 1}}{\frac{\alpha_i(\alpha_i + 1 - x_i)}{\alpha_i + 1} + \frac{(\alpha_i + 1)(x_i - \alpha_i)}{\alpha_i + 2}} \\ &= \max_{i \in [h]} \frac{x_i(\alpha_i + 1)(\alpha_i + 2)}{(x_i + 1)(x_i + \alpha_i^2 + \alpha_i)}. \end{aligned}$$

The last quantity is maximized for  $x_i = \sqrt{\alpha_i(\alpha_i + 1)}$  and  $\alpha_i = 1$  which yields the claim.  $\square$

#### 4.2.2 LOWER BOUND

In the following we show that, in general, the price of stability of fractional hedonic games played on unweighted bipartite graphs is strictly greater than 1, i.e., there are games for which no optimal coalition structure is Nash stable.

Before proving this result, we need the following technical lemma.

**Lemma 12.** *Let  $C_i$  and  $C_j$  be two coalitions such that  $G_{C_i} := K_{a_i, b_i}$ ,  $G_{C_j} := K_{a_j, b_j}$  and  $G_{C_i \cup C_j} := K_{a_i + a_j, b_i + b_j}$  are complete bipartite graphs. Then  $\text{SW}(C_i \cup C_j) \geq \text{SW}(C_i) + \text{SW}(C_j)$  with equality holding if and only if  $a_i b_j = a_j b_i$ .*

*Proof.* We have,  $\text{SW}(C_i) = \frac{2a_i b_i}{a_i + b_i}$ ,  $\text{SW}(C_j) = \frac{2a_j b_j}{a_j + b_j}$  and  $\text{SW}(C_i \cup C_j) = \frac{2(a_i + a_j)(b_i + b_j)}{a_i + a_j + b_i + b_j}$ . Since  $a_i, a_j, b_i, b_j > 0$ , inequality  $\frac{2(a_i + a_j)(b_i + b_j)}{a_i + a_j + b_i + b_j} \geq \frac{2a_i b_i}{a_i + b_i} + \frac{2a_j b_j}{a_j + b_j}$  is equivalent to  $(b_i a_j - a_i b_j)^2 \geq 0$  which yields the claim.  $\square$

We are now ready to prove the lower bound result.

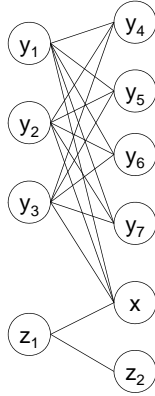

Figure 3: An unweighted bipartite graph yielding a fractional hedonic game with price of stability strictly greater than 1.0025.

**Theorem 11.** *There exists an unweighted bipartite graph  $G$  such that  $\text{PoS}(\mathcal{G}(G)) = \frac{400}{399} > 1.0025$ .*

*Proof.* Let  $G$  be the unweighted bipartite graph depicted in Figure 3. Set  $Y_1 = \{y_i : i \in [3]\}$  and  $Y = \{y_i : i \in [7]\}$ . Define  $\mathbf{C}^*$  such that  $C_1^* = Y$  and  $C_2^* = \{x, z_1, z_2\}$ . Observe that  $\text{SW}(\mathbf{C}^*) = \frac{100}{21}$  and that  $\mathbf{C}^*$  is not Nash stable since agent  $x$  improves by deviating to coalition  $C_1^*$ . Denote with  $\tilde{\mathbf{C}} := (\mathbf{C}_{-x}^*, C_1^*)$  the coalition structure obtained after this deviation. It is easy to see that  $\tilde{\mathbf{C}}$  is Nash stable and  $\text{SW}(\tilde{\mathbf{C}}) = \frac{19}{4}$ . We shall prove that  $\mathbf{C}^*$  is the unique social optimum for  $\mathcal{G}(G)$  and that  $\tilde{\mathbf{C}}$  is the Nash stable coalition structure with maximum social welfare in  $\mathcal{G}(G)$ . This will imply  $\text{PoS}(\mathcal{G}(G)) \geq \frac{400}{399}$ .

Fix a coalition structure  $\mathbf{C}$ . Depending on which agents belong to  $\mathbf{C}(x)$ , we can distinguish among three cases:

- $\mathbf{C}(x) \cap \{z_1, z_2\} = \emptyset$ . Observe that, in this case, in order to maximize  $\text{SW}(\mathbf{C})$ , there must be a coalition  $C_i \in \mathbf{C}$  such that  $C_i = \{z_1, z_2\}$ . For the remaining nodes, since  $Y \cup \{x\}$  induces a complete bipartite graph, by Lemma 12, we have that  $\text{SW}(\mathbf{C})$  is maximized when there exists a coalition  $C_j \in \mathbf{C}$  such that  $C_j = Y \cup \{x\}$ , i.e.,  $\mathbf{C} = \tilde{\mathbf{C}}$ . Thus, in this case, the maximum social welfare that can be obtained by any coalition structure  $\mathbf{C}$  is not higher than  $\text{SW}(\tilde{\mathbf{C}})$ .
- $\mathbf{C}(x) \cap Y = \emptyset$ . Observe that, in order to maximize  $\text{SW}(\mathbf{C})$ , there must be a coalition  $C_i \in \mathbf{C}$  such that  $C_i = \{x, z_1, z_2\}$ . For the remaining nodes, since  $Y$  induces a complete bipartite graph, by Lemma 12, we have that  $\text{SW}(\mathbf{C})$  is maximized when there exists a coalition  $C_j \in \mathbf{C}$  such that  $C_j = Y$ , i.e.,  $\mathbf{C} = \mathbf{C}^*$ . Thus, in this case, the maximum social welfare that can be obtained by any coalition structure  $\mathbf{C}$  is not higher than  $\text{SW}(\mathbf{C}^*) = \frac{100}{21}$ . It is important to note that  $\mathbf{C}^*$  is the unique coalition structure achieving a social welfare of  $\frac{100}{21}$ . Consider, to this aim, any splitting of the nodes in  $Y$  into two or more coalitions. Only the three cases given in Figure 4 are

possible and in all of them the social welfare is always smaller than  $\text{SW}(\tilde{\mathbf{C}})$ . Hence, it also follows that, in this case, any Nash stable coalition structure achieves a social welfare not higher than  $\text{SW}(\tilde{\mathbf{C}})$ .

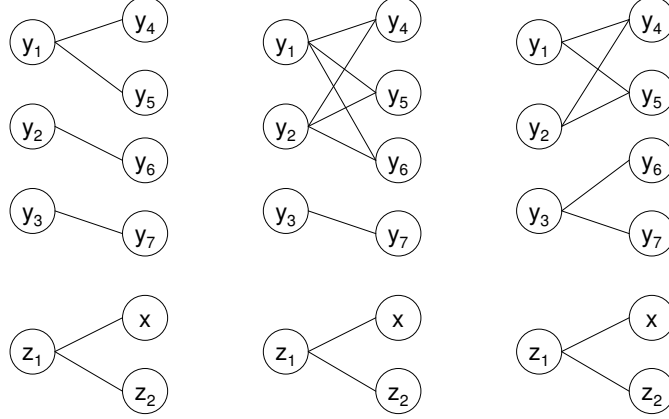

Figure 4: The three different coalition structures that may be possible when  $\mathbf{C}(x) \cap Y = \emptyset$  and  $Y$  is split into at least two coalitions.

- $\mathbf{C}(x) \supset \{y_i, z_j\}$  for some  $i \in [7]$  and  $j \in [2]$ . Observe that, in order to maximize  $\text{SW}(\mathbf{C})$ , it must be  $i \in [3]$  and  $j = 1$  which also implies  $z_2 \in \mathbf{C}(x)$ . Since  $G$  is symmetric with respect to  $Y_1$ , we can assume without loss of generality that  $\mathbf{C}(x) \supset \{x, y_1, z_1, z_2\}$ . Denote  $A := \mathbf{C}(x) \setminus \{x, y_1, z_1, z_2\}$ . Since all the nodes not belonging to  $\mathbf{C}(x)$  induce a complete bipartite graph, by Lemma 12, we have that  $\text{SW}(\mathbf{C})$  is maximized when there exists a coalition  $C_i \in \mathbf{C}$  such that  $C_i = N \setminus \mathbf{C}(x)$ , so that  $|C_i| = 6 - |A|$ . If  $|A| = 0$ , which implies  $C_i = Y \setminus \{y_1\}$ , we have  $\text{SW}(\mathbf{C}) = \text{SW}(\mathbf{C}(x)) + \text{SW}(C_i) = \frac{3}{2} + \frac{8}{3} < \text{SW}(\tilde{\mathbf{C}})$ . Hence, assume  $|A| > 0$ . Since both  $A$  and  $C_i$  induce a triangle-free graph, it follows from Turán's Theorem (Theorem 1) that  $\mathbf{C}(x)$  has at most  $|A|^2/4 + |A| + 3$  edges and  $C_i$  has at most  $(6 - |A|)^2/4$  edges. Hence, we get  $\text{SW}(\mathbf{C}) = \text{SW}(\mathbf{C}(x)) + \text{SW}(C_i) \leq \frac{2(|A|^2/4 + |A| + 3)}{|A| + 4} + \frac{2((6 - |A|)^2/4)}{6 - |A|} = \frac{6(|A| + 5)}{|A| + 4}$  which is smaller than  $\text{SW}(\tilde{\mathbf{C}})$  for any  $|A| > 0$ . Thus, also in this case, the maximum social welfare that can be obtained by any coalition structure  $\mathbf{C}$  is not higher than  $\text{SW}(\tilde{\mathbf{C}})$ .

Hence, since we have proved that  $\mathbf{C}^*$  is the unique social optimum for  $\mathcal{G}(G)$  and that  $\tilde{\mathbf{C}}$  is the Nash stable coalition structure with maximum social welfare in  $\mathcal{G}(G)$ , the theorem follows.  $\square$

### 4.3 Unweighted Trees

In this subsection, we focus on fractional hedonic games played on unweighted trees. We first show that any social optimum is made of small coalitions of diameter 1 or 2, and then we show that the price of stability is equal to 1.

**Lemma 13.** *Let  $G = (N, E)$  be an unweighted tree, with  $|N| \geq 2$ . For any social optimum  $\mathbf{C}^*$  for  $\mathcal{G}(G)$ , it holds that  $G_{C_i^*}$  is a tree,  $|C_i^*| \geq 2$  and  $d(C_i^*) \in \{1, 2\}$ , for every  $i \in [n]$ .*

*Proof.* Since  $G$  is a tree and  $\mathbf{C}^*$  is connected, we have that  $G_{C_i^*}$  is a tree, for every  $i \in [n]$ .

We observe that in  $\mathbf{C}^*$  there cannot exist any coalition  $C_i^*$  containing only one agent. Suppose that  $|C_i^*| = 1$ . Then, since  $|N| \geq 2$ , there must exist some non-empty coalition  $C_j^*$  adjacent to  $C_i^*$ . Let  $q_j = |C_j^*| \geq 1$ . By merging  $C_i^*$  and  $C_j^*$  we increase the social welfare by  $\frac{2q_j}{q_j+1} - \frac{2(q_j-1)}{q_j} > 0$ , contradicting the optimality of  $\mathbf{C}^*$ . Hence, each coalition  $C_i^*$  in  $\mathbf{C}^*$  induces a tree containing at least two agents, and its contribution to the social welfare is  $\frac{2(|C_i^*|-1)}{|C_i^*|}$ .

Now let us assume that there exists a coalition  $C_i^*$  having diameter strictly larger than 2. Then there must exist two adjacent agents in  $G_{C_i^*}$ , say  $u$  and  $v$ , having both degree in  $G_{C_i^*}$  at least equal to 2. The existence of such agents guarantees that the coalition  $C_i^*$  can be split into two coalitions, containing agents  $u$  and  $v$  respectively, and each with diameter at least 1, and thus at least two agents. Formally, let  $C_{i,u}^*$  and  $C_{i,v}^*$  be two coalitions such that  $u \in C_{i,u}^*$ ,  $v \in C_{i,v}^*$  and  $C_{i,u}^* \cup C_{i,v}^* = C_i^*$ . Moreover let  $q_u = |C_{i,u}^*|$  and  $q_v = |C_{i,v}^*|$ . We know that  $q_u, q_v \geq 2$ . The contribution of  $C_i^*$  to the social welfare is  $\text{SW}(C_i^*) = \frac{2(q_u+q_v-1)}{q_u+q_v}$ . If we split  $C_i^*$  into the two coalitions  $C_{i,u}^*$  and  $C_{i,v}^*$ , we obtain a new coalition structure whose social welfare increases by

$$\Delta = \text{SW}(C_{i,u}^*) + \text{SW}(C_{i,v}^*) - \text{SW}(C_i^*) = \frac{2(q_u-1)}{q_u} + \frac{2(q_v-1)}{q_v} - \frac{2(q_u+q_v-1)}{q_u+q_v}.$$

It is easy to see that  $\Delta > 0$  for every  $q_u, q_v \geq 1$ . In fact,

$$\Delta = 2 \left( 1 - \frac{1}{q_u} - \frac{1}{q_v} + \frac{1}{q_u+q_v} \right) \geq \frac{2}{q_u+q_v} > 0,$$

because  $\left( \frac{1}{q_u} + \frac{1}{q_v} \right) \leq 1$ . □

We are now ready to prove the main result of this subsection, concerning the price of stability of games played on unweighted trees.

**Theorem 12.** *Let  $G = (N, E)$  be an unweighted tree with  $|N| \geq 2$ . Any social optimum  $\mathbf{C}^*$  for  $\mathcal{G}(G)$  is Nash stable, i.e.,  $\text{PoS}(\mathcal{G}(G)) = 1$ .*

*Proof.* From Lemma 13 we know that each coalition in  $\mathbf{C}^*$  induces a tree with at least two agents and diameter 1 or 2. Notice also that, since  $G$  is acyclic, an agent  $u$  is adjacent to a single agent belonging to any coalition  $C_j^*$  adjacent to  $\mathbf{C}^*(u)$ . This implies that by deviating to  $C_j^*$ ,  $u$  would obtain a payoff of  $\frac{1}{|C_j^*|+1}$ .

Let us first observe that every agent  $u$  with at least two adjacent agents in  $\mathbf{C}^*(u)$ , i.e., with  $|N_u(\mathbf{C}^*(u))| \geq 2$ , is stable. In fact  $p_u(\mathbf{C}^*) = \frac{|N_u(\mathbf{C}^*(u))|}{|N_u(\mathbf{C}^*(u))|+1} \geq 2/3$ , whereas the payoff she would get after deviating to any other coalition  $C_j^*$  is at most  $\frac{1}{|C_j^*|+1} \leq 1/3$ .

Let us now consider the agents having only one adjacent agent in the same coalition. Let  $u$  be such that  $|N_u(\mathbf{C}^*(u))| = 1$  and  $q_i = |\mathbf{C}^*(u)| \geq 2$ . If  $q_i = 2$  then  $u$  is stable. In fact  $p_u(\mathbf{C}^*) = 1/2$ , whereas the payoff she would get after deviating to any other coalition  $C_j^*$  is at most  $\frac{1}{|C_j^*|+1} \leq 1/3$ . If  $q_i \geq 3$ , let us assume that  $u$  wants to deviate to coalition  $C_j^*$ . Let  $q_j = |C_j^*| \geq 2$ . The payoff of  $u$  before the deviation is  $\frac{1}{q_i}$ , whereas her payoff after the deviation is  $\frac{1}{q_j+1}$ . Thus, in order for it to be an improving deviation, it must hold that  $q_j \leq q_i - 2$ . But the change in the social welfare is

$$\begin{aligned}
 \Delta &= \text{SW}(\mathbf{C}^*(u), C_j^*) - \text{SW}(\mathbf{C}^*) \\
 &= \left( \text{SW}(\mathbf{C}(u) \setminus \{u\}) + \text{SW}(C_j^* \cup \{u\}) \right) - \left( \text{SW}(\mathbf{C}(u)) + \text{SW}(C_j^*) \right) \\
 &= \left( \text{SW}(C_j^* \cup \{u\}) - \text{SW}(C_j^*) \right) - \left( \text{SW}(\mathbf{C}(u)) - \text{SW}(\mathbf{C}(u) \setminus \{u\}) \right) \\
 &= \left( \left( 2 - \frac{2}{q_j+1} \right) - \left( 2 - \frac{2}{q_j} \right) \right) - \left( \left( 2 - \frac{2}{q_i} \right) - \left( 2 - \frac{2}{q_i-1} \right) \right) \\
 &= 2 \left( \frac{1}{q_j(q_j+1)} - \frac{1}{q_i(q_i-1)} \right) \\
 &\geq \frac{2}{q_i-1} \left( \frac{1}{(q_i-2)} - \frac{1}{q_i} \right) \tag{5} \\
 &> 0, \tag{6}
 \end{aligned}$$

where (5) holds because  $q_j \leq q_i - 2$ , and (6) because  $q_i \geq 3$ . This contradicts the fact that  $\mathbf{C}^*$  is a social optimum.  $\square$

## 5. Computation

In this section, we focus on the efficient computation of Nash stable coalition structures with good performance guarantees. After having provided some negative results for games played on general graph topologies, in subsections 5.1, 5.2 and 5.3, we focus on the special cases of games played on unweighted triangle free graphs, unweighted bipartite graphs and unweighted trees, respectively.

We start by showing that the class of fractional hedonic games does not possess the finite improvement path property, even considering best-response dynamics. In particular, we show that there may exist best-response dynamics of infinite length even in games played on unweighted bipartite graphs. This means that a Nash stable coalition structure may not be computed by a best-response dynamics and, in particular, it cannot be reached by independent agents unless some kind of centralized control is enforced in the game.

**Theorem 13.** *There exists a fractional hedonic game played on an unweighted bipartite graph admitting a best-response dynamics of infinite length.*

*Proof.* Let  $G$  be the unweighted bipartite graph depicted in Figure 5 and define

$$\sigma = \{ \{x_0, \dots, x_5, a_1, \dots, a_5\}, \{z_1, \dots, z_{21}\}, \{y_0, \dots, y_5, b_1, \dots, b_5\} \}.$$

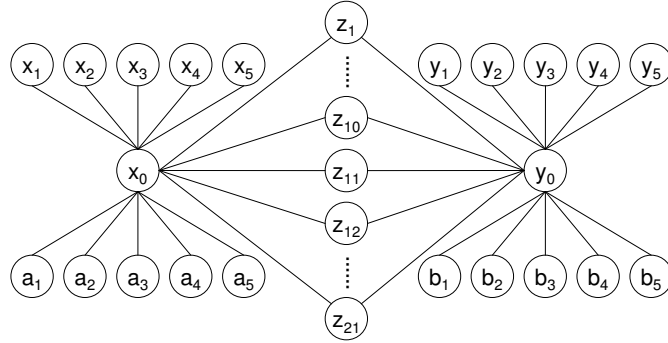

Figure 5: A bipartite graph yielding a fractional hedonic game not converging to a Nash stable coalition structure even under a best-response dynamics.

We consider the best-response dynamics starting from  $\sigma$  in which a subset of 12 agents are processed cyclically according to the following ordering:

$$\langle x_0, y_0, x_1, \dots, x_5, y_1, \dots, y_5, x_0, y_0, x_1, \dots, x_5, y_1, \dots, y_5 \rangle.$$

It is easy to see that the first 12 best-responses consist in joining coalition  $C_2$ , while, in the last 12 ones, each node goes back to the coalition originally occupied in  $\sigma$ , thus creating a best-response dynamics of infinite length.  $\square$

The last result raises the question of the existence of efficient algorithms computing Nash stable coalition structures with high social welfare. To this aim, we denote with  $\text{COMPUTE BEST STABLE}(\mathcal{G}(G))$  the problem of computing a Nash stable coalition structure of maximum welfare and with  $\text{COMPUTE OPT}(\mathcal{G}(G))$  the problem of computing a social optimum of a given game  $\mathcal{G}(G)$ . In Theorem 14, whose proof is in Appendix D, we prove the intractability of these problems.

**Theorem 14.** *Both problems  $\text{COMPUTE BEST STABLE}(\mathcal{G}(G))$  and  $\text{COMPUTE OPT}(\mathcal{G}(G))$  are NP-hard.*

Given the negative nature of the two results that we proved so far for games played on general graphs, in the next three subsections, we restrict to special graph topologies, i.e., unweighted triangle-free graphs, unweighted bipartite graphs and unweighted trees.

### 5.1 Unweighted Triangle-Free Graphs

We have already proved in Section 4 an upper bound of  $\frac{18}{7}$  on the price of stability for games played on unweighted triangle free graphs. Since the proof of Theorem 8 is constructive, i.e., it shows that the coalition structure returned by Algorithm 1 is Nash stable and approximates the social optimum by a factor at most equal to  $\frac{18}{7}$ , in order to show that it is possible to efficiently compute a coalition structure with the same approximation guarantee, it suffices to prove that Algorithm 1 terminates in polynomial time.

**Theorem 15.** *Given a triangle free unweighted graph  $G$ , Algorithm 1 computes in polynomial time a Nash stable coalition structure  $\tilde{\mathbf{C}}$  for  $\mathcal{G}(G)$  such that  $\text{SW}(\mathbf{C}^*) \leq \frac{18}{7} \cdot \text{SW}(\tilde{\mathbf{C}})$ .*

*Proof.* Given Theorem 8, we only need to show that Algorithm 1 terminates in polynomial time. It is immediate to see that, since each line of Algorithm 1 can be executed in polynomial time, we only need to prove that the better-response dynamics implemented by the while-cycle at Lines 17–21 terminates after a polynomial number of iterations. To this aim, given a star coalition structure  $\mathbf{C}$ , denote with  $\Phi(\mathbf{C}) = \sum_{u \notin c(\mathbf{C})} p_u(\mathbf{C})$ . Observe that, since  $p_u(\mathbf{C}) \leq 1/2$  for each  $u \notin c(\mathbf{C})$ , it follows that  $\Phi(\mathbf{C}) \leq |N \setminus c(\mathbf{C})|/2$ . Moreover,  $c(\mathbf{C}^k) = c(\mathbf{C}^{k+1})$  for each  $k \geq 0$ .

Consider a coalition structure  $\mathbf{C}^{k+1} = (\mathbf{C}_{-u}^k, C_j^k)$ . Since  $i$  is an improving deviation for agent  $u$  in  $\mathbf{C}^k$ , it holds that  $p_u(\mathbf{C}_{-u}^k, C_j^k) > p_u(\mathbf{C}^k)$ . Moreover since  $u \notin c(\mathbf{C}^k)$  and, by Lemma 3,  $\mathbf{C}^k$  is a star coalition structure, this inequality becomes  $\frac{1}{|C_j^k|+1} > \frac{1}{|C^k(u)|}$  which implies  $|C^k(u)| \geq |C_j^k| + 2$ .

We now prove that  $\Phi(\mathbf{C}^{k+1}) - \Phi(\mathbf{C}^k) \geq \Omega\left(\frac{1}{|N \setminus c(\mathbf{C}^0)|^3}\right)$ , i.e., function  $\Phi$  increases by a factor of  $\Omega\left(\frac{1}{|N \setminus c(\mathbf{C}^0)|^3}\right)$  at each improving deviation. Observe that agent  $u$ 's deviation only affects the payoffs of the agents in  $\mathbf{C}^k(u)$  and  $C_j^k$ . Thus we have:

$$\begin{aligned}
 \Phi(\mathbf{C}^{k+1}) - \Phi(\mathbf{C}^k) &= \frac{|C^k(u)| - 2}{|C^k(u)| - 1} + \frac{|C_j^k|}{|C_j^k| + 1} - \frac{|C^k(u)| - 1}{|C^k(u)|} - \frac{|C_j^k| - 1}{|C_j^k|} \\
 &= \frac{1}{|C^k(u)|} + \frac{1}{|C_j^k|} - \frac{1}{|C^k(u)| - 1} - \frac{1}{|C_j^k| + 1} \\
 &= \frac{1}{(|C_j^k|)(|C_j^k| + 1)} - \frac{1}{(|C^k(u)|)(|C^k(u)| - 1)} \\
 &\geq \frac{1}{(|C_j^k|)(|C_j^k| + 1)} - \frac{1}{(|C_j^k| + 2)(|C_j^k| + 1)} \\
 &= \frac{2}{|C_j^k| + 2} \cdot \frac{1}{(|C_j^k|)(|C_j^k| + 1)} \\
 &= \Omega\left(\frac{1}{|N \setminus c(\mathbf{C}^0)|^3}\right),
 \end{aligned} \tag{7}$$

where all the denominators are strictly greater than zero since both  $C_j^k$  and  $\mathbf{C}^k(u)$  are stars, and inequality (7) holds since  $|C^k(u)| \geq |C_j^k| + 2$ .  $\square$

## 5.2 Unweighted Bipartite Graphs

In Theorem 13, we have already proved that even best-response dynamics may not converge to Nash stable coalition structures in games defined by unweighted bipartite graphs. Moreover, even though we have shown that these games have a very low price of stability, by Theorem 4 we know that there are Nash stable coalition structures that might have a very low social welfare. Therefore, finding an efficient Nash stable coalition structures for games played on this restricted graph topology is an interesting and non-trivial task.

In this subsection, we show how that the Nash stable coalition structure  $\tilde{\mathbf{C}}$  returned by Algorithm 1 has a social welfare of at least one-half that of an optimal coalition structure.

**Theorem 16.** *Given an unweighted bipartite graph  $G$ , Algorithm 1 computes in polynomial time a Nash stable coalition structure  $\tilde{\mathbf{C}}$  for  $\mathcal{G}(G)$  such that  $\text{SW}(\mathbf{C}^*) \leq 2 \cdot \text{SW}(\tilde{\mathbf{C}})$ .*

*Proof.* Fix an unweighted bipartite graph  $G$ . Since  $G$  is also triangle-free, it follows from Theorem 9 and Theorem 15 that Algorithm 1 computes in polynomial time a Nash stable coalition structure  $\tilde{\mathbf{C}}$  for  $\mathcal{G}(G)$ . Thus, we are just left to show the approximation guarantee. As we have already discussed in the proof of Lemma 3, for each  $k \geq 0$ ,  $|\mathbf{C}^k| = |M|$  which implies  $|\tilde{\mathbf{C}}| = |M|$ . Since, for each non empty coalition  $\tilde{C} \in \tilde{\mathbf{C}}$ ,  $\text{SW}(\tilde{C}) \geq 1$ , it follows that  $\text{SW}(\tilde{\mathbf{C}}) \geq |M|$ . By König's Theorem, stating that the size of a maximum matching in a bipartite graph equals that of a minimum vertex cover, it follows that, denoted by  $VC$  a minimum vertex cover for  $G$ ,  $\text{SW}(\tilde{\mathbf{C}}) \geq |VC|$ . The claim then follows by applying Lemma 1.  $\square$

### 5.3 Unweighted Trees

In this subsection, we focus on games played on unweighted trees. We show that the social optimum can be computed in polynomial time. In order to prove this result, we will also exploit the property proved in Lemma 13, stating that the social optimum is made of small coalitions of diameter 1 or 2.

A *rooted tree* is a tree in which there is a distinguished node called *root*. Let  $G = (N, E)$  be a tree and let  $r \in N$  be the root. For every  $u \in N$ ,  $\text{Ancestors}_r(G, u)$  denotes the set of the *ancestors* of  $u$ , that is the set of all nodes, except  $u$ , along the unique path connecting  $u$  to  $r$ . The *level* of  $u$  is the length of the path (number of edges) connecting  $u$  to  $r$  and it is denoted as  $\text{Level}_r(G, u)$ . The level of the root is 0. If  $v \in \text{Ancestors}_r(G, u)$  and  $\{u, v\} \in E$  then  $v$  is the *parent* of  $u$ , denoted as  $\text{Parent}_r(G, u)$ .  $\text{Descendants}_r(G, u)$  denotes the set of the *descendants* of  $u$ , that is the set of all nodes of which  $u$  is an ancestor. If  $v \in \text{Descendants}_r(G, u)$  and  $\{u, v\} \in E$  then  $v$  is a *child* of  $u$ . The set of all children of  $u$  is denoted as  $\text{Children}_r(G, u)$ . A node who does not have any child is called a *leaf*. The set of all leaves of the tree is denoted as  $\text{Leaves}_r(G)$ . The height of the rooted tree is the maximum length of a path connecting  $r$  and any node, and it is denoted as  $\text{Height}_r(G)$ .

Given a game  $\mathcal{G}(G)$ , where  $G = (N, E)$ , a *labeling function*, or simply a labeling, is any function of the type  $N \mapsto \{\text{Internal}, \text{External}\}$ , assigning a label in the set  $\{\text{Internal}, \text{External}\}$  to each agent in  $N$ . Let  $f$  be a labeling, if  $f(u) = \text{Internal}$ , we say  $u$  is an internal agent, if  $f(u) = \text{External}$  we say  $u$  is an external agent.

**Definition 6.** *Given a game  $\mathcal{G}(G)$ , where  $G = (N, E)$ , we say that a labeling function  $f : N \mapsto \{\text{Internal}, \text{External}\}$  is compatible with a connected coalition structure  $\mathbf{C}$ , if  $f$  satisfies the following properties:*

- For every  $C_i \in \mathbf{C}$  such that  $|C_i| = 1$ , the only agent in  $C_i$  is an internal agent. Formally, if  $C_i = \{u\}$ , then  $f(u) = \text{Internal}$ ;
- For every  $C_i \in \mathbf{C}$  such that  $|C_i| = 2$ , exactly one agent is internal and the other one is external. Formally, let  $C_i = \{u, v\}$ , then either  $f(u) = \text{Internal}$  and  $f(v) = \text{External}$  or  $f(u) = \text{External}$  and  $f(v) = \text{Internal}$ ;



- For every  $C_i \in \mathbf{C}$  such that  $|C_i| \geq 3$ , only the agents with a single neighbor in the same coalition are external, while the remaining ones are internal. Formally, for every  $u \in C_i$ ,  $f(u) = \text{External}$  if  $N_u(\mathbf{C}(u)) = 1$ , and  $f(u) = \text{Internal}$  otherwise.

In the next remark, we summarize some properties of the labeling functions deriving from the above definition, which result to be useful in the proof of Lemma 14.

**Remark 1.** Given a game  $\mathcal{G}(G)$ , where  $G = (N, E)$ , let  $f : N \mapsto \{\text{Internal}, \text{External}\}$  be a labeling function compatible with a connected coalition structure  $\mathbf{C}$  for  $\mathcal{G}(G)$ , the following properties hold:

1. In a coalition there cannot exist two adjacent agents who are both external, i.e., if  $\{u, v\} \in E$ ,  $u, v \in C_i$  and  $f(u) = \text{External}$  then  $f(v) = \text{Internal}$ ;
2. If the subgraph induced by a coalition is a tree with diameter at most 2, then in such a coalition there is exactly one internal agent, i.e., if  $G_{C_i}$  is a tree such that  $d(C_i) \leq 2$ , then  $\exists u \in C_i : f(u) = \text{Internal}$ , and  $\forall v \in C_i \setminus \{u\}, f(v) = \text{External}$ .

**Definition 7.** Given a game  $\mathcal{G}(G)$ , where  $G = (N, E)$ , we say that a labeling  $f : N \mapsto \{\text{Internal}, \text{External}\}$  is optimal for  $\mathcal{G}(G)$ , if there exists a social optimum  $\mathbf{C}^*$  for  $\mathcal{G}(G)$  such that  $f$  is compatible with  $\mathbf{C}^*$ .

Next lemma, whose proof is in Appendix E, characterizes the optimal labeling functions.

**Lemma 14.** Given a game  $\mathcal{G}(G)$ , where  $G = (N, E)$  is a tree, for any root  $r \in N$ ,

$$f(u) = \begin{cases} \text{Internal} & \text{if } \exists v \in \text{Children}_r(G, u) : f(v) = \text{External} \\ \text{External} & \text{otherwise} \end{cases}$$

is an optimal labeling function for  $\mathcal{G}(G)$ .

---

#### Algorithm 2 Social optimum

---

```

1: procedure OPTCS( $G = (N, E)$ ) //  $G$  is a tree
2:   Fix a root  $s \in N$ 
3:   Compute an optimal labeling  $g : N \mapsto \{\text{Internal}, \text{External}\}$  of  $G$  rooted at  $s$ 
4:   for each  $x \in N : g(x) = \text{Internal}$  do
5:      $\mathbf{C}(x) = \{x\}$  // Initialize the coalition of each internal agent to  $\{x\}$ 
6:   end for
7:   if  $g(s) = \text{Internal}$  then
8:     OPTCS_INT( $s$ )
9:   else
10:    for each  $x \in \text{Children}_s(G, s)$  do // Each  $x$  is an internal agent
11:      OPTCS_INT( $x$ )
12:    end for
13:    OPTCS_EXT( $s$ )
14:   end if
15: end procedure

```

---

In the next Theorem, we use the optimal labeling defined in Lemma 14 to compute a social optimum.

**Theorem 17.** *Let  $G = (N, E)$  be a tree. Algorithm 2 returns a social optimum for  $\mathcal{G}(G)$  in polynomial time.*

Let us start by describing Algorithm 2. By fixing a root  $s \in N$ , the algorithm starts by computing an optimal labeling function  $g$  with respect the root  $s$ , as described by Lemma 14. The labeling function can be efficiently computed by performing a postorder traversal of the rooted tree. We know that a social optimum has a coalition for each internal agent. This suggests that the social optimum is obtained by carefully deciding, for each internal agent  $x$ , which of the external agents adjacent to  $x$  are in the same coalition with  $x$ . For every internal agent  $x$ , we let  $\mathbf{C}(x)$  denote the coalition currently constructed by the algorithm for  $x$ ; this coalition is initialized to  $\{x\}$ , [line 5]. Subsequently, we construct the coalition structure  $\mathbf{C}$  according to whether  $s$  has been labeled **Internal** or **External**, [line 7 – 14], and this task is performed by the two sub-procedures `OPTCS_INT` and `OPTCS_EXT`.

Throughout the remainder of this section, we will assume that the labeling  $g$  and the root  $s$  are the ones computed and fixed by `OPTCS`, respectively. Moreover, for ease of exposition, in the reminder of this section, for every agent  $x$ , we define  $T_x^s = \text{Descendants}_s(G, x) \cup \{x\}$ .

Let us now describe Procedure `OPTCS_INT`. It takes as input an internal agent  $u$  and returns the optimal coalition structure for the game  $\mathcal{G}(G_{T_u^s})$ , as stated by Lemma 17. Let us now show how `OPTCS_INT` works. The procedure starts by initializing  $\mathbf{C}(u)$  to the set of children of  $u$  which are external agents, that is  $S_1 = \{x \in \text{Children}_s(G, u) : g(x) = \text{External}\}$ , [line 3]. Let  $S_2$  be the agents in  $S_1$  having children, i.e.,  $S_2 = \{v_1, v_2 \dots, v_k\} = \{x \in S_1 : \text{Children}_s(G, x) \neq \emptyset\}$ ,  $k \geq 0$ . The set of children of  $v_i$  is denoted as  $W_i = \{\text{Children}_s(G, v_i)\}$ , for  $i \in [1, k]$ , [line 5]. Notice that, by the definition of the optimal labeling  $g$ , all agents in  $W_i$  are internal. Every agent in  $S_1 \setminus S_2$  necessarily belongs to the same coalition of  $u$  in any social optimum. Instead, in the social optimum, an agent  $v_i \in S_2$  could potentially join the same coalition of one of his children in  $W_i$ . Therefore, `OPTCS_INT` iteratively weeds out from  $\mathbf{C}(u)$  part of the agents in  $S_2$ , [lines 6-25]. In particular, after recursively running `OPTCS_INT` on each game  $\mathcal{G}(G_{T_x^s})$ , for every  $x \in W_i$  and  $i \in [1, k]$ , [lines 7-11], for every set  $W_i$  we pick the agent that, in the coalition structure  $\mathbf{C}$  returned by the recursive call of `OPTCS_INT`, belongs to the smallest coalition, and we denote it by  $w_i^* \in \arg \min_{x \in W_i} |\mathbf{C}(x)|$ , [line 12]. We assume that such selected agents are ordered by the size of the coalition they belong to, i.e.,  $|\mathbf{C}(w_i)| \leq |\mathbf{C}(w_{i+1})|$  for each  $i \in [1, (k - 1)]$ , [line 14]. The decision of whether  $v_i$  must be removed from  $\mathbf{C}(u)$  merely depends on the size of the coalition  $\mathbf{C}(w_i)$ . In fact, the algorithm goes through the agents in  $S_2$  from  $v_1$  to  $v_k$  and, at each step  $i$  of the **while** loop, [lines 17 – 21], it removes  $v_i$  from her current coalition  $\mathbf{C}(u)$ , if the size of  $\mathbf{C}(u)$  is strictly larger than the size of  $\mathbf{C}(w_i)$ , and adds it to  $Q$ . The last step consists in running the procedure `ORDER` on  $w_i$  and  $v_i$ , for every  $v_i$  in  $Q$ , [lines 22 – 24]. As we will prove later, the call of `ORDER` allows to compute the social optimum for the game  $\mathcal{G}(G_{T_{w_i}^s \cup v_i}^s)$ , starting from the social optimum for  $\mathcal{G}(G_{T_{w_i}^s}^s)$ , previously computed by the recursive call of `OPTCS_INT` on  $w_i$ . In order to show how `ORDER` works, we need to introduce the notion of *alternating pair* and *alternating path*.

**Definition 8.** *Given any coalition structure  $\mathbf{C} = \{\mathbf{C}(x)\}_{x:g(x)=\text{Internal}}$ , an alternating pair with respect to  $\mathbf{C}$  starting at  $x_0$  is a sequence of agents  $\langle x_0, y_0, x_1, y_1 \rangle$ , such that  $\{(x_0, y_0), (y_0, x_1), (x_1, y_1)\} \subseteq E$ ,  $y_0 \in \text{Children}_s(G, x_0)$ ,  $x_1 \in \text{Children}_s(G, y_0)$ ,  $y_1 \in \text{Children}_s(G, x_1)$ ,  $y_0 \in \mathbf{C}(x_0)$ ,  $y_1 \in \mathbf{C}(x_1)$  finally  $g(x_0) = g(x_1) = \text{Internal}$  and  $g(y_0) =$*

---

```

1: procedure OPTCS_INT( $u \in N$ ) //  $u$  is an internal agent
2:   Let  $S_1 = \{x \in \text{Children}_s(G, u) : g(x) = \text{External}\}$ 
3:    $\mathbf{C}(u) = S_1$  // Initialize the coalition of  $u$  with all the external children of  $u$ 
4:   Let  $S_2 = \{v_1, v_2, \dots, v_k\} = \{x \in S_1 : \text{Children}_s(G, x) \neq \emptyset\}$ 
5:   Let  $W_i = \text{Children}_s(G, v_i)$  for each  $i \in [1, k]$  // The agents in  $W_i$  are internal
6:   if  $S_2 \neq \emptyset$  then
7:     for  $i = 1 \dots k$  do
8:       for each  $x \in W_i$  do
9:         // Compute the social optimum for the subgame
10:        OPTCS_INT( $x$ )
11:      end for
12:      Let  $w_i^* \in \arg \min_{x \in W_i} |\mathbf{C}(x)|$ 
13:    end for
14:    Let us assume that  $|\mathbf{C}(w_j^*)| \leq |\mathbf{C}(w_{j+1}^*)|$  for each  $j \in [1, (k-1)]$ 
15:     $i = 1$ 
16:     $Q = \emptyset$ 
17:    while  $(|\mathbf{C}(u)| \geq |\mathbf{C}(w_i^*)| + 1) \wedge (i \leq k)$  do
18:       $\mathbf{C}(u) = \mathbf{C}(u) \setminus \{v_i\}$ 
19:       $Q = Q \cup \{v_i\}$ 
20:       $i = i + 1$ 
21:    end while
22:    for every  $v_j \in Q$  do
23:      OPTCS_EXT( $v_j$ )
24:    end for
25:  end if
26: end procedure

```

---

$g(y_1) = \text{External}$ . We say that the alternating pair is ordered if  $|\mathbf{C}(x_0)| \leq |\mathbf{C}(x_1)|$ . An alternating path with respect to  $\mathbf{C}$  starting at  $x_0$  is a sequence of agents  $\langle x_0, y_0, x_1, y_1, \dots, x_p, y_p \rangle$ , such that,  $\langle x_i, y_i, x_{i+1}, y_{i+1} \rangle$  is an alternating pair, for every  $i \in [0, p]$  and  $p \geq 1$  (we say that  $\mathbf{C}(x_p)$  is reached by an alternating path from  $x_0$ ). We say that the alternating path is ordered if all alternating pairs composing it are ordered.

Given as input an internal agent  $x$  and an external agent  $y$ , with  $x \in \text{Children}_s(G, y)$ , the goal of ORDER is to put  $y$  in the same coalition of  $x$  and check whether there exists a non-ordered alternating pair  $\langle x_0, y_0, x_1, y_1 \rangle$  with  $x_0 = x$ ; if so, it breaks this pair by removing  $y_0$  from his current coalition and applying recursively the procedure to  $x_1$  and  $y_0$  (notice that, in the next call of ORDER,  $y_0$  will be added to the coalition of  $x_1$ ). Notice that, after the execution of ORDER only one coalition increases its size by one unit.

The proof of Theorem 17 directly follows from Lemmas 15, 17 and 16, whose proofs are in Appendix E.

For the ease of exposition, for any coalition structure  $\mathbf{C}$  and any agents  $x, v$  such that  $v \notin \mathbf{C}(x)$  and  $\{x, v\} \in E$ , define  $\Delta(\mathbf{C}, x, v) = \text{SW}(\mathbf{C}(x) \cup \{v\}) - \text{SW}(\mathbf{C}(x)) > 0$ , that is, the increase in the social welfare of the coalition of  $x$  due to the insertion of  $v$ .

---

```

1: procedure OPTCS_EXT( $v \in N$ ) //  $v$  is an external agent
2:   Let  $w \in \arg \min_{x \in \text{Children}_s(G,v)} |\mathbf{C}(x)|$ 
3:   ORDER( $w, v$ )
4: end procedure

```

---

```

1: procedure ORDER( $x \in N, y \in N$ ) //  $g(x) = \text{Internal}, g(y) = \text{External}$  and  $x \in \text{Children}_s(G, y)$ 
2:    $\mathbf{C}(x) = \mathbf{C}(x) \cup \{y\}$ 
3:   if there exists an alternating pair  $\langle x_0, y_0, x_1, y_1 \rangle$ , with  $x_0 = x$  and  $(|\mathbf{C}(x_0)| \geq |\mathbf{C}(x_1)| + 1)$  then
4:      $\mathbf{C}(x_0) = \mathbf{C}(x_0) \setminus \{y_0\}$ 
5:     ORDER( $x_1, y_0$ )
6:   end if
7: end procedure

```

---

**Lemma 15.** Let  $\mathbf{C}^* = \{\mathbf{C}^*(x)\}_{x \in T_u^s: g(x) = \text{Internal}}$  be the coalition structure at the end of the execution of OPTCS\_INT on input  $u$ . For every internal agent  $x_0 \in T_u^s$ , every alternating path  $\langle x_0, y_0, x_1, y_1, \dots, x_p, y_p \rangle$  with respect to  $\mathbf{C}^*$  is ordered.

**Lemma 16.** Given that an optimal solution for all children of  $v$  has been already computed, the call of OPTCS\_EXT on input  $v$  ( $v$  being an external agent) returns a social optimum for  $\mathcal{G}(G_{T_v^s})$  in polynomial time. Moreover, let  $w$  the agent selected at line 2 of OPTCS\_EXT; it holds that  $\text{Opt}(\mathcal{G}(G_{T_v^s})) = \text{Opt}(\mathcal{G}(G_{T_w^s})) + \Delta(\mathbf{C}', w, v)$ .

**Lemma 17.** If  $g(u) = \text{Internal}$ , OPTCS\_INT returns social optimum for  $\mathcal{G}(G_{T_u^s})$  in polynomial time in the size of the game.

## 6. Conclusions

We have studied fractional hedonic games and have provided quite negative results for games played on general graphs and positive results for games played on unweighted triangle-free graphs, unweighted bipartite graphs and unweighted trees. In particular, the latter results include the existence of polynomial time algorithms computing Nash stable coalition structures with provable good performances.

Olsen (2012) investigates computational issues and the existence of Nash stable outcomes in a variant of (symmetric) fractional hedonic games in which, with respect to the model considered in this paper, the utility function of an agent is defined as the ratio between the utility of the agent in the coalition and the cardinality of the coalition minus 1, that is, without considering the contribution of the agent herself to the population of the coalition structure. Let us call *full-rank* utility function the one we consider in this paper and *almost full-rank* utility function the one considered by Olsen. Although the difference between the two functions might seem “almost” negligible, the sets of Nash stable outcomes they induce in games played on a same graph are usually quite different. In fact, while for the almost full-rank utility function considered by Olsen it is shown that in any non-star graph with at least four nodes there always exists a Nash stable coalition structure differing from the

basic one, when adopting the full-rank one, there exist plenty of non-trivial graphs with an arbitrary number of nodes possessing just one Nash stable coalition structure (obviously being the basic one)<sup>2</sup>. The main reason behind this difference is the fact that the almost full-rank utility function is robust with respect to coalitions which are cliques, whereas the full-rank one is not. In fact, according to the almost full-rank utility function, all the agents in a coalition being a clique gets a utility equal to 1 independently of the cardinality of the coalition. When using the full-rank utility function, instead, the utility that each agent gets when being in a clique is strictly less than 1 and increases towards 1 as the cardinality of the clique increases. This implies that, while a partition into cliques is Nash stable for the almost full-rank utility function, this is not the case for the full-rank one; for instance, to break the stability of a partition into cliques, it suffices that there exists an agent being part of a clique of cardinality  $h$  who, by joining another clique of cardinality  $k \geq h$ , creates a coalition which is also a clique.

We stress that many of the results given in this paper can be extended also to the almost full-rank utility function as follows. Observations 2 and 3, that is the non-existence of Nash stable coalition structure when considering graphs with negative weights and the existence of the basic Nash stable coalition structure in the case of non-negative weights, extend directly with the same proofs. Theorems 3, 4 and 5 which asymptotically characterize the price of anarchy in any case and the price of stability in the weighted case keep holding with the same bounds by readapting *mutatis mutandis* the relative proofs. Finally, but more importantly, the positive results concerning the upper bounds on the price of stability and the existence of polynomial time algorithms for computing good Nash stable coalition structures in unweighted triangle-free graphs, unweighted bipartite graphs and unweighted trees (in particular, the results of Theorems 8, 9, 10, 12, 15, 16, 17) keep holding thanks to the following lemma, because they exploit partitions into stars for providing Nash stable coalition structures.

**Lemma 18.** *For any given unweighted graph  $G$ , any Nash stable coalition structure for the full-rank utility function which is a partition into stars of  $G$  is also Nash stable for the almost full-rank one.*

*Proof.* Fix an unweighted graph  $G$  and a Nash stable coalition structure  $\mathbf{C}$  for the game  $\mathcal{G}(G)$  defined by the full-rank utility function which is a partition into stars of  $G$ . Consider a generic agent  $u$  belonging to a generic coalition  $C_i$  being a star of order  $k$ , with  $k \geq 2$ . We show that, for any coalition  $C_j$  in  $\mathbf{C}$  being a star of order  $h$ , with  $h \geq 2$ , if  $u$  does not improve when joining  $C_j$  under the full-rank utility function, then  $u$  does not improve when joining  $C_j$  also under the almost full-rank utility function.

Assume first that  $u$  is the center of  $C_i$ , then her utility in  $\mathbf{C}$  under the almost full-rank utility function is 1 which is the maximum utility achievable under this model, so  $u$  can never improve her situation by migrating to a different coalition. Hence, assume that  $u$  is a leaf of  $C_j$ , then her utility in  $\mathbf{C}$  is  $1/k$  under the full-rank utility function and  $1/(k-1)$  under the almost full-rank utility function. By deviating to  $C_j$ ,  $u$  gets a utility of  $\alpha_j/(h+1)$  under the full-rank utility function and of  $\alpha_j/h$  under the almost full-rank utility function, where  $\alpha_j$  is the number of edges connecting  $u$  with nodes in  $C_j$ . Then, we need to show

---

2. One such a graph can be found in the proof of Theorem 6.

that the following implication holds:

$$\frac{1}{k} \geq \frac{\alpha_j}{h+1} \Rightarrow \frac{1}{k-1} \geq \frac{\alpha_j}{h}. \quad (8)$$

Note that implication (8) trivially holds when  $\alpha_j = 0$ . So assume that  $\alpha_j \geq 1$ . By rearranging the terms, implication (8) can be rewritten as (recall that  $k \geq 2$ ):

$$k\alpha_j \leq h+1 \Rightarrow k\alpha_j \leq h + \alpha_j$$

which holds under the assumption  $\alpha_j \geq 1$ .

Thus, by the arbitrariness of  $u$ ,  $C_i$  and  $C_j$  it follows that  $\mathbf{C}$  is a Nash stable coalition structure also under the almost full-rank utility model.  $\square$

It is important to note that a symmetric version of the above lemma does not hold. This justifies the preference we accorded to the full-rank utility function in this paper with respect to the almost full-rank one which has been also addressed in the literature.

There are several open problems that still need to be addressed, as outlined in Tables 3 and 4. For instance, some of the provided upper and lower bounds are not tight, so there are some gaps that need to be closed. Among them, the major one is that requiring the determination significant upper bound to the price of stability for general unweighted graphs. Another interesting research direction would be considering directed graphs where the weight of a directed arc  $(u, v)$  denotes the value agent  $u$  has for agent  $v$ .

## Acknowledgements

Preliminary versions of this work appeared in Proceedings of the 10th Conference on Web and Internet Economics (Bilò et al., 2014), and in Proceedings of the 14th International Conference on Autonomous Agents and Multi-Agent Systems (Bilò et al., 2015).

This work was partially supported by PRIN 2010–2011 research project *ARS TechnoMedia: “Algorithmics for Social Technological Networks”*, by the project ANR-14-CE24-0007-01 “*CoCoRiCo-CoDec*” and COST Action IC1205 on “*Computational Social Choice*”.

## Appendix A. Proofs from Section 3

### A.1 Proof of Theorem 2

*Proof.* We say that two nodes  $u, v \in N$  form a *critical pair* for a coalition structure  $\mathbf{C}$ , if  $\{u, v\} \in E$  and  $\max\{p_u(\mathbf{C}), p_v(\mathbf{C})\} < \frac{1}{2}$ . Clearly, any coalition structure possessing a critical pair cannot be a 2-Strongly Nash stable coalition structure, since both agents can improve their utility by simultaneously deviating to the same empty coalition.

Consider the unweighted graph  $G = (N, E)$  depicted in Figure 6. Fix a Nash stable coalition structure  $\mathbf{C}$ . By the topology of  $G$ , the following four properties hold:

**Property 4.** *Each non-empty coalition of  $\mathbf{C}$  contains at least two nodes.*

To prove Property 4, assume, by way of contradiction, that  $|C_i| = 1$  for some  $i \in [n]$ . Let us denote with  $u$  the unique agent choosing coalition  $C_i$ . It follows that  $p_u(\mathbf{C}) = 0$ . Since  $G$  is connected, there exists a coalition  $C_j \neq C_i$  such that  $p_u(\mathbf{C}_{-u}, C_j) > 0$ , thus contradicting the fact that  $\mathbf{C}$  is a Nash stable coalition structure.

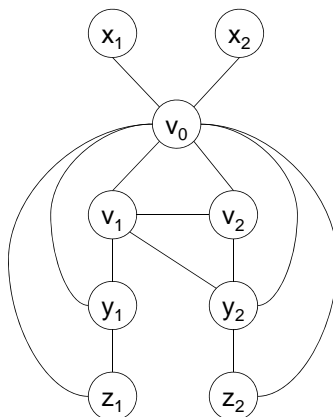

Figure 6: A graph yielding a fractional hedonic game with no 2-Strongly Nash stable coalition structures.

**Property 5.** *In  $\mathbf{C}$ , there always exists a coalition containing the set of nodes  $\{x_1, x_2, v_0\}$ .*

To prove Property 5, assume, by way of contradiction, that  $\mathbf{C}(x_i) \neq \mathbf{C}(v_0)$  for some  $i \in [2]$ . Then, it follows that  $p_{x_i}(\mathbf{C}) = 0$ , while  $p_{x_i}(\mathbf{C}_{-x_i}, \mathbf{C}(v_0)) > 0$ , thus contradicting the fact that  $\mathbf{C}$  is a Nash stable coalition structure.

**Property 6.**  *$\mathbf{C}$  is such that  $|\mathbf{C}(v_0)| > |C_i|$  for each  $i \in [n]$ .*

To prove Property 6, assume, by way of contradiction, that  $|\mathbf{C}(v_0)| \leq |C_i|$  for some  $C_i \neq \mathbf{C}(v_0)$ . Since  $v_0$  is connected with every other vertex in  $G$ , we obtain  $p_{v_0}(\mathbf{C}) = \frac{|\mathbf{C}(v_0)|-1}{|\mathbf{C}(v_0)|} < \frac{|C_i|}{|C_i|+1} = p_{v_0}(\mathbf{C}_{-v_0}, C_i)$ , thus contradicting the hypothesis that  $\mathbf{C}$  is a Nash stable coalition structure.

**Property 7.** *For any index  $i \in [2]$ , if  $\mathbf{C}(z_i) \neq \mathbf{C}(v_0)$ , then there exists a coalition in  $\mathbf{C}$  containing the set of nodes  $\{y_i, z_i\}$ .*

To prove Property 7, assume, by way of contradiction, that there exists an index  $i \in [2]$  such that  $\mathbf{C}(z_i) \neq \mathbf{C}(v_0)$  and  $\mathbf{C}(y_i) \neq \mathbf{C}(z_i)$ . Then, it follows that  $p_{z_i}(\mathbf{C}) = 0 < p_{z_i}(\mathbf{C}_{-z_i}, \mathbf{C}(v_0))$ , thus contradicting the hypothesis that  $\mathbf{C}$  is a Nash stable coalition structure.

Since a 2-Strongly Nash stable coalition structure is also Nash stable by definition, it follows that any 2-Strongly Nash stable coalition structure needs to satisfy the above four properties. Since  $|N| = 9$ , it comes from Property 4 that a 2-Strongly Nash stable coalition structure can have at most 4 non-empty coalitions. We show that  $\mathcal{G}(G)$  cannot have 2-Strongly Nash equilibria by considering all possible coalition structures having at most 4 non-empty coalitions and satisfying the above four properties. (In the remainder of this proof, we will define a certain coalition structure by only listing its non-empty coalitions in decreasing order of cardinality, so that  $\mathbf{C}(v_0) = C_1$ , because of Property 6).

**Case 1: Coalition structures with 1 non-empty coalition.** In such a case, the only candidate coalition structure is  $\widehat{\mathbf{C}}$  which cannot be a 2-Strongly Nash stable coalition structure since it contains the critical pair formed by nodes  $v_1$  and  $v_2$ .

**Case 2: Coalition structures with 4 non-empty coalitions.** By Properties 4 and 6, we can assume without loss of generality that  $\mathbf{C}$  is such that  $|C_1| = 3$  and  $|C_i| = 2$  for  $2 \leq i \leq 4$ . By Properties 5 and 7, it follows that there exists a unique candidate coalition structure  $\mathbf{C} = \{\{x_1, x_2, v_0\}, \{y_1, z_1\}, \{y_2, z_2\}, \{v_1, v_2\}\}$  with 4 non-empty coalitions. Anyway,  $\mathbf{C}$  is not even Nash stable since  $y_2$  can improve her payoff by deviating to  $C_4$ .

**Case 3: Coalition structures with 3 non-empty coalitions.** By Properties 4 and 6, it follows that only two cases for  $\mathbf{C}$  are possible: the one in which  $|C_1| = 5$  and  $|C_2| = |C_3| = 2$  or the one in which  $|C_1| = 4$ ,  $|C_2| = 3$  and  $|C_3| = 2$ .

Let us start with the first case. To this aim note that, since the set of nodes  $S = \{v_1, v_2, y_2\}$  induces a clique in  $G$ , there cannot be a Nash stable coalition structure in which two nodes of  $S$  are in the same coalition  $C \neq C_1$  because the agent corresponding to the node of  $S$  not belonging to  $C$ , call it  $u$ , can always improve her utility by deviating to  $C$  ( $u$  gets  $2/3$  when deviating to  $C$  and there are no coalitions in which  $u$  can get at least  $2/3$ ). Using this argument and Property 7, it follows that only two candidate coalition structures, namely,  $\mathbf{C}_1 = \{\{x_1, x_2, v_0, v_1, v_2\}, \{y_1, z_1\}, \{y_2, z_2\}\}$  and  $\mathbf{C}_2 = \{\{x_1, x_2, v_0, v_2, z_1\}, \{v_1, y_1\}, \{y_2, z_2\}\}$  are possible.  $\mathbf{C}_1$  is not a 2-Strongly Nash stable coalition structure since it contains the critical pair formed by nodes  $v_1$  and  $v_2$ , while  $\mathbf{C}_2$  is not even Nash stable since  $z_1$  can improve by deviating to  $C_2$ .

For the second case, since  $|C_1| = 4$  and  $\{x_1, x_2, v_0\} \subset C_1$ , we have to distinguish among four subcases depending on which is the fourth node in  $C_1$  (in fact, note that, by Property 7, none of the nodes  $y_i$  cannot belong to  $C_1$ ). We stress that, also in this case, there cannot exist a Nash stable coalition structure in which two nodes of  $S$  are in coalition  $C_3$ . Because of these observations, the following six candidate coalition structures

$$\begin{aligned} \mathbf{C}_1 &= \{\{x_1, x_2, v_0, v_1\}, \{v_2, y_2, z_2\}, \{y_1, z_1\}\}, \mathbf{C}_2 = \{\{x_1, x_2, v_0, v_2\}, \{v_1, y_2, z_2\}, \{y_1, z_1\}\}, \\ \mathbf{C}_3 &= \{\{x_1, x_2, v_0, v_2\}, \{v_1, y_1, z_1\}, \{y_2, z_2\}\}, \mathbf{C}_4 = \{\{x_1, x_2, v_0, z_1\}, \{v_1, v_2, y_1\}, \{y_2, z_2\}\}, \\ \mathbf{C}_5 &= \{\{x_1, x_2, v_0, z_1\}, \{v_2, y_2, z_2\}, \{v_1, y_1\}\}, \mathbf{C}_6 = \{\{x_1, x_2, v_0, z_2\}, \{v_1, v_2, y_2\}, \{y_1, z_1\}\} \end{aligned}$$

are possible. In  $\mathbf{C}_1$ ,  $v_1$  can improve by deviating to  $C_3$ , in  $\mathbf{C}_2$ ,  $v_2$  can improve by deviating to  $C_2$ , in  $\mathbf{C}_3$ ,  $v_2$  can improve by deviating to  $C_3$ , in  $\mathbf{C}_4$ , the pair of nodes  $\{v_0, z_1\}$  can improve by deviating to  $C_2$ , in  $\mathbf{C}_5$ ,  $z_1$  can improve by deviating to  $C_3$  and, in  $\mathbf{C}_6$ , the pair of nodes  $\{v_0, z_2\}$  can improve by deviating to  $C_2$ . So, no 2-Strongly Nash stable coalition structures may exist in this case as well.

**Case 4: Coalition structures with 2 non-empty coalitions.** Because of Property 6, it follows that only three cases for  $\mathbf{C}$  are possible: the one in which  $|C_1| = 7$  and  $|C_2| = 2$ , the one in which  $|C_1| = 6$  and  $|C_2| = 3$  and the one in which  $|C_1| = 5$  and  $|C_2| = 4$ .

For the first case, by Property 4, six candidate coalition structures are possible, namely  $\mathbf{C}_1, \dots, \mathbf{C}_6$ , respectively defined by the following choices for  $C_2$ :

$$C_2 \in \{\{v_1, v_2\}, \{v_1, y_1\}, \{v_2, y_2\}, \{v_1, y_2\}, \{y_1, z_1\}, \{y_2, z_2\}\}.$$



In  $\mathbf{C}_1$ ,  $y_2$  can improve by deviating to  $C_2$ , in  $\mathbf{C}_2$ ,  $v_2$  can improve by deviating to  $C_2$ , in  $\mathbf{C}_3$ ,  $v_1$  can improve by deviating to  $C_2$ , in  $\mathbf{C}_4$ ,  $v_2$  can improve by deviating to  $C_2$ , while in both  $\mathbf{C}_5$  and  $\mathbf{C}_6$ , nodes  $v_1$  and  $v_2$  form a critical pair.

For the second case, by Property 4, five candidate coalition structures are possible, namely  $\mathbf{C}_1, \dots, \mathbf{C}_5$ , respectively defined by the following choices for  $C_2$ :

$$C_2 \in \{\{v_1, v_2, y_1\}, \{v_1, v_2, y_2\}, \{v_1, y_1, z_1\}, \{v_1, y_2, z_2\}, \{v_2, y_2, z_2\}\}.$$

In  $\mathbf{C}_1$ ,  $z_1$  can improve by deviating to  $C_2$ , in  $\mathbf{C}_2$ ,  $z_2$  can improve by deviating to  $C_2$ , in both  $\mathbf{C}_3$  and  $\mathbf{C}_4$ ,  $v_1$  can improve by deviating to  $C_1$ , while in  $\mathbf{C}_5$ ,  $v_1$  can improve by deviating to  $C_2$ .

For the third case, by Property 4, seven candidate coalition structures are possible, namely  $\mathbf{C}_1, \dots, \mathbf{C}_7$ , respectively defined by the following choices for  $C_2$ :

$$C_2 \in \{\{v_1, v_2, y_1, y_2\}, \{v_1, v_2, y_1, z_1\}, \{v_1, v_2, y_2, z_2\}, \{v_1, y_1, y_2, z_1\}\} \cup \\ \cup \{\{v_1, y_1, y_2, z_2\}, \{v_1, y_1, y_2, z_1\}, \{y_1, y_2, z_1, z_2\}\}.$$

In  $\mathbf{C}_1$ ,  $y_1$  can improve by deviating to  $C_1$ , in  $\mathbf{C}_2$ ,  $v_2$  can improve by deviating to  $C_1$ , in  $\mathbf{C}_3$ , nodes  $y_1$  and  $z_1$  form a critical pair, in  $\mathbf{C}_4$ ,  $y_2$  can improve by deviating to  $C_1$ , in  $\mathbf{C}_5$ ,  $y_1$  can improve by deviating to  $C_1$ , while in both  $\mathbf{C}_6$  and  $\mathbf{C}_7$ , nodes  $y_1$  and  $z_1$  form a critical pair.  $\square$

## Appendix B. Proofs from Subsection 4.1

### B.1 Proof of Lemma 2

*Proof.* First, observe that after Line 10, there are  $|M|$  non-empty coalitions each containing a pair of nodes corresponding to an edge of  $M$ . Since the set *Covered* in never changed after Line 10 and no node is removed from a coalition during the for-cycle at Lines 11–14, it follows that, during the execution of Lines 12 and 13, for each non-empty coalition  $C_i$ , exactly two nodes of  $C_i$  belong to *Covered*.

To prove the claim, we need to show that (i) Line 12 of Algorithm 1 can always be performed and (ii) at the end of Line 13, coalition  $\mathbf{C}(v)$  is a star.

To show the first part, fix a node  $u \notin \text{Covered}$ . Since  $G$  has no isolated nodes, there exists  $v \in N$  such that  $\{u, v\} \in E$ . If  $v \notin \text{Covered}$ , then  $M \cup \{u, v\}$  is a matching for  $G$ , thus contradicting the optimality of  $M$ . Hence, it must be  $v \in \text{Covered}$  which implies that Line 12 can be performed.

To show the second part, since after Line 10 all coalitions in  $\mathbf{C}$  are stars, assume that there is an iteration of the for-cycle at Lines 11–14 such that  $\mathbf{C}(v)$  is a star and  $\mathbf{C}(v) \cup \{u\}$  is not. This implies that  $|\mathbf{C}(v)| \geq 3$  and that  $v \in \ell(G_{\mathbf{C}(v)})$ . Observe that, since the two nodes of  $\mathbf{C}(v)$  belonging to *Covered* are  $c(G_{\mathbf{C}(v)})$  and  $v$ ,  $\{c(G_{\mathbf{C}(v)}), v\} \in M$ . Now choose a node  $x \in \mathbf{C}(v) \setminus \{c(G_{\mathbf{C}(v)}), v\}$  which exists since  $|\mathbf{C}(v)| \geq 3$ . Clearly,  $\{c(G_{\mathbf{C}(v)}), x\} \in E$  since  $\mathbf{C}(v)$  is a star centered at  $c(G_{\mathbf{C}(v)})$ . Nodes  $u, x \notin \text{Covered}$ , so they are not incident to any edge of  $M$ . It follows that  $M \setminus \{c(G_{\mathbf{C}(v)}), v\} \cup \{u, v\} \cup \{c(G_{\mathbf{C}(v)}), x\}$  is a matching for  $G$ , thus contradicting the optimality of  $M$ .  $\square$

## B.2 Proof of Lemma 3

*Proof.* The proof is by induction on  $k$ . Clearly, for  $k = 0$ , the claim follows from Lemma 2. Assume, by way of contradiction, that there exists an index  $k \geq 0$  such that  $\mathbf{C}^k$  is a star coalition structure for  $\mathcal{G}(G)$ , while  $\mathbf{C}^{k+1}$  is not. This implies that there exists a node  $u = \arg \min_{v \in N_{\text{ID}}(\mathbf{C}^k) \setminus c(\mathbf{C}^k)} \{p_v(\mathbf{C}^k)\}$  with an improving deviation to coalition  $C_j^k$  leading from  $\mathbf{C}^k$  to  $\mathbf{C}^{k+1} = (\mathbf{C}_{-u}^k, C_j^k)$  such that either  $\mathbf{C}^k(u) \setminus \{u\}$  or  $C_j^k \cup \{u\}$  is not a star.

Assume first that  $\mathbf{C}^k(u) \setminus \{u\}$  is not a star. This implies  $|\mathbf{C}^k(u)| = 2$  so that  $p_u(\mathbf{C}^k) = 1/2$ . We distinguish between two cases. If  $\{u, c(G_{C_j^k})\} \in E$ , then, since  $G$  is triangle-free,  $p_u(\mathbf{C}^{k+1}) = \frac{1}{|C_j^k|+1} \leq \frac{1}{3}$  since  $|C_j^k| \geq 2$ , thus contradicting  $p_u(\mathbf{C}^k) < p_u(\mathbf{C}^{k+1})$ . If  $\{u, c(G_{C_j^k})\} \notin E$ , then there must exist a node  $z \in C_j^k$ , with  $z \neq c(G_{C_j^k})$ , such that  $\{u, z\} \in E$ . Since  $G$  is triangle-free,  $p_u(\mathbf{C}^{k+1}) \leq \frac{|C_j^k|-1}{|C_j^k|+1}$ . By  $p_u(\mathbf{C}^k) < p_u(\mathbf{C}^{k+1})$ , we derive  $|C_j^k| \geq 4$  which implies  $p_z(\mathbf{C}^k) \leq \frac{1}{4}$ . By  $\{u, z\} \in E$ , we derive  $p_z(\mathbf{C}_{-z}^k, \mathbf{C}^k(u)) = 1/3 > p_z(\mathbf{C}^k)$  which implies  $z \in N_{\text{ID}}(\mathbf{C}^k) \setminus c(\mathbf{C}^k)$ . Since  $p_u(\mathbf{C}^k) = 1/2$  and  $p_z(\mathbf{C}^k) \leq \frac{1}{4}$ , we get a contradiction to  $u = \min_{v \in N_{\text{ID}}(\mathbf{C}^k) \setminus c(\mathbf{C}^k)} \{p_v(\mathbf{C}^k)\}$ .

Assume now that  $C_j^k \cup \{u\}$  is not a star. This implies that  $|C_j^k| \geq 3$  and that there exists a node  $v \in \ell(G_{C_j^k})$  such that  $\{u, v\} \in E$ . Moreover, we have already proved that  $\mathbf{C}^k(u) \setminus \{u\}$  has to be a star which implies  $|\mathbf{C}^k(u)| \geq 3$ . Let  $\mathbf{C}'$  be the coalition structure obtained from  $\mathbf{C}^k$  by removing  $u$  from  $\mathbf{C}^k(u)$ ,  $v$  from  $C_j^k$  and then placing both of them in an empty coalition  $C'$ . By  $|\mathbf{C}^k(u)| \geq 3$  and  $u \neq c(G_{\mathbf{C}^k(u)})$ , it follows that  $\mathbf{C}^k(u) \setminus \{u\}$  is a star; by  $|C_j^k| \geq 3$  and  $v \in \ell(G_{C_j^k})$ , it follows that  $C_j^k \setminus \{v\}$  is a star; and by  $\{u, v\} \in E$ , it follows that  $C'$  is a star. So,  $\mathbf{C}'$  is a star coalition structure for  $\mathcal{G}(G)$  with  $|\mathbf{C}'| > |\mathbf{C}^k|$ . Now observe that, since a center never leaves her coalition and a node never deviates to an empty coalition,  $|M| = |\mathbf{C}^k|$  for each  $k \geq 0$ . Moreover, a star coalition structure  $\mathbf{C}$  for  $\mathcal{G}(G)$  induces in a natural way a matching  $M(\mathbf{C})$  for  $G$  such that  $|M(\mathbf{C})| = |\mathbf{C}|$ . Thus, having constructed a star coalition structure  $\mathbf{C}'$  for  $\mathcal{G}(G)$  such that  $|\mathbf{C}'| > |\mathbf{C}^k|$ , we get a contradiction to the optimality of  $M$ .  $\square$

## Appendix C. Proofs from Subsection 4.2

### C.1 Proof of Lemma 5

*Proof.* Assume, by way of contradiction, that there exists an edge  $\{u, v\} \in E(C^*)$  such that  $u \in L_i$  and  $v \in K_j$  with  $j > i$ . Let  $S_q^{f^*}$  be a star such that  $S_q^{f^*} \in A_i$  and  $u \in \ell(S_q^{f^*})$  and let  $S_r^{f^*}$  be the star such that  $S_r^{f^*} \in A_j$  and  $u = c(S_r^{f^*})$ . Hence, the function  $f'$  obtained from  $f^*$  by moving an arbitrarily small quantity  $\epsilon > 0$  from  $f^*(u, q)$  to  $f^*(u, r)$  belongs to  $\mathcal{F}(V^*)$ . We obtain

$$\begin{aligned} & \text{SW}(\mathbf{S}^{f^*}) - \text{SW}(\mathbf{S}^{f'}) \\ &= \frac{2x_i}{x_i + 1} + \frac{2x_j}{x_j + 1} - \frac{2(x_i - \epsilon)}{x_i + 1 - \epsilon} - \frac{2(x_j + \epsilon)}{x_j + 1 + \epsilon} \\ &= 2\epsilon \left( \frac{1}{(x_i + 1)(x_i + 1 - \epsilon)} - \frac{1}{(x_j + 1)(x_j + 1 + \epsilon)} \right) \end{aligned}$$

$$< 0,$$

where the last inequality comes from  $x_i > x_j$  and the arbitrariness of  $\epsilon$ . We have derived  $\text{SW}(\mathbf{S}^{f^*}) < \text{SW}(\mathbf{S}^{f'})$  thus contradicting the optimality of  $\mathbf{S}^{f^*}$ .  $\square$

### C.2 Proof of Lemma 8

*Proof.* In order to show the claim, we resort on a reduction argument to the flow circulation problem in which, given a directed network, every node  $u$  has a demand  $d(u)$  and each edge  $e = \{u, v\}$  a lower bound  $l(u, v)$  and upper bound  $c(u, v)$  on the amount of flow that must circulate along it. A circulation is a flow assignment to the edges satisfying the edges bounds and such that for every node  $u$  the total amount of flow entering  $u$  minus the total amount leaving  $u$  is equal to  $d(u)$ . In other words, a node with negative demand is injecting new flow in the network, while one with positive demand is consuming flow.

Given a set of fractional stars  $A_i$ , let us create an instance of the flow circulation problem as follows:  $\tilde{G} = (\tilde{V}, \tilde{E})$ , with  $\tilde{V} = K_i \cup L_i \cup \{s, t\}$  and  $\tilde{E} = E(K_i \cup L_i) \cup \{\{s, u\} : u \in K_i\} \cup \{\{u, t\} : u \in L_i\}$ ; node demands are  $d(s) = -l_i$ ,  $d(t) = l_i$ , and  $d(u) = 0$  for all the remaining nodes  $u \in K_i \cup L_i$ ; finally, the lower and upper bounds on the allowed flow along the edges are  $l(s, u) = \lfloor x_i \rfloor$  and  $c(s, u) = \lceil x_i \rceil$  for each  $\{s, u\} \in \tilde{E}$ , and  $l(u, v) = 0$  and  $c(u, v) = 1$  for all the remaining edges  $\{u, v\} \in \tilde{E}$ .

Consider then the following circulation of flow  $f$ :  $f(s, u) = x_i$  for each edge  $\{s, u\} \in \tilde{E}$ ,  $f(u, v)$  is equal to the value of the fractional assignment  $A_i$  associated to edge  $\{u, v\} \in E(K_i \cup L_i)$ , and finally  $f(u, v) = 1$  for every  $\{u, v\} \in \tilde{E}$ .

Then, since all demands and lower and upper bounds on the flow of the edges are integers, and  $f$  is a feasible circulation, there is also a feasible circulation  $f'$  for  $\tilde{G}$  that is integer-valued. By construction,  $f'$  induces a star coalition structure  $\mathbf{S}^{f'}$  centered at  $K_i$  of the set of nodes  $K_i \cup L_i$ . Moreover, by the edge constraints, every star must have order either  $\lfloor x_i \rfloor + 1$  or  $\lceil x_i \rceil + 1$ .

Now let  $z_i$ , with  $0 \leq z_i \leq k_i$ , be the number of stars in  $\mathbf{S}^{f'}$  having order equal to  $\lfloor x_i \rfloor + 1$ . It follows that  $z_i \lfloor x_i \rfloor + (k_i - z_i) \lceil x_i \rceil = l_i$  and  $\sum_{j \in [k_i]} \text{SW}(S_j) = 2 \left( \frac{z_i \lfloor x_i \rfloor}{\lfloor x_i \rfloor + 1} + \frac{(k_i - z_i) \lceil x_i \rceil}{\lceil x_i \rceil + 1} \right)$ .  $\square$

### C.3 Proof of Lemma 9

*Proof.* Assume that  $\mathbf{S}^*$  is not Nash stable, otherwise we are done. We obtain  $\mathbf{C}$  by manipulating  $\mathbf{S}^*$  as follows. Whenever there exist two stars  $S, S' \in \mathbf{S}^*$  such that  $|\ell(S)| > |\ell(S')| + 1$  and  $\{c(S'), u\} \in E$  for some  $u \in \ell(S)$ , remove  $u$  from  $S$  and add it to  $S'$ . It is easy to see that the total social welfare increases. Similarly, whenever there exist two stars  $S, S' \in \mathbf{S}^*$  such that  $|\ell(S)| \geq 2$ ,  $|\ell(S')| \geq 2$  and  $\{u, v\} \in E$  for some  $u \in \ell(S)$  and  $v \in \ell(S')$ , remove  $u$  from  $S$ ,  $v$  from  $S'$  and create a new star formed by edge  $\{u, v\}$ . Again, the total social welfare increases. Finally, whenever there exist two stars  $S, S' \in \mathbf{S}^*$  such that  $|\ell(S)| = 1$ ,  $|\ell(S')| \geq 3$  and  $\{u, v\} \in E$  for some  $u \in \ell(S)$  and  $v \in \ell(S')$ , remove  $v$  from  $S'$  and add it to  $S$ . Again, the total social welfare increases. Denote with  $\mathbf{C}$  the star coalition structure obtained at the end of this process. Clearly,  $\text{SW}(\mathbf{C}) \geq \text{SW}(\mathbf{S}^*)$ . We now show that  $\mathbf{C}$  is Nash stable.

Let  $u$  be an agent who possesses an improving deviation in  $\mathbf{C}$  by migrating to a coalition  $C$  (inducing a star) and let  $i = |\ell(G_{\mathbf{C}(u)})|$  and  $j = |\ell(G_C)|$ . Assume  $u = c(G_{\mathbf{C}(u)})$ . From

the one hand,  $p_u(\mathbf{C}) = \frac{i}{i+1}$ . From the other hand, since  $G$  is triangle-free,  $p_u(\mathbf{C}_{-u}, C) \leq \frac{j}{j+2} \leq \frac{i+1}{i+3}$ , where the last inequality follows from the construction of  $\mathbf{C}$ . It follows that such an improving deviation is not possible. So, assume  $u \in \ell(G_{\mathbf{C}(u)})$ . We have  $p_u(\mathbf{C}) = \frac{1}{i+1}$ . If  $\{u, v\} \in E$  for some  $v \in \ell(G_C)$ , then, by the construction of  $\mathbf{C}$ , it must be  $i = 1 \wedge j = 1$ , or  $i = 1 \wedge j = 2$ , or  $i = 2 \wedge j = 1$ . It is easy to see that, in all of these three cases, such an improving deviation is not possible and this concludes the proof.  $\square$

#### C.4 Proof of Lemma 11

*Proof.* We prove the claim by induction on  $h$ .

For  $h = 1$ , the base of the induction is trivially verified.

As to the inductive step, by assuming true the claim for  $h = n$ , we prove that it also holds for  $h = n + 1$ .

$$\begin{aligned}
 \frac{\sum_{i \in [n+1]} l_i k_{\leq i}}{\sum_{i \in [n+1]} (k_i + l_i)} &= \frac{\sum_{i \in [n]} l_i k_{\leq i}}{\sum_{i \in [n+1]} (k_i + l_i)} + \frac{l_{n+1} k_{\leq n+1}}{\sum_{i \in [n+1]} (k_i + l_i)} \\
 &\leq \frac{\sum_{i \in [n]} l_i k_{\leq i}}{\sum_{i \in [n]} (k_i + l_i)} + \frac{l_{n+1} k_{\leq n+1}}{\sum_{i \in [n+1]} (k_i + l_i)} \\
 &\leq \sum_{i \in [n]} \frac{k_i l_i}{k_i + l_i} + \frac{k_{n+1} l_{n+1}}{k_{n+1} + l_{n+1}} \\
 &= \sum_{i \in [n+1]} \frac{k_i l_i}{k_i + l_i}.
 \end{aligned} \tag{9}$$

Notice that, by the inductive hypothesis,  $\frac{\sum_{i \in [n]} l_i k_{\leq i}}{\sum_{i \in [n]} (k_i + l_i)} \leq \sum_{i \in [n]} \frac{k_i l_i}{k_i + l_i}$ ; therefore, in order to prove inequality (9), it remains to show that  $\frac{l_{n+1} k_{\leq n+1}}{\sum_{i \in [n+1]} (k_i + l_i)} \leq \frac{k_{n+1} l_{n+1}}{k_{n+1} + l_{n+1}}$ , that is equivalent to

$$\frac{k_{\leq n+1}}{\sum_{i \in [n+1]} (k_i + l_i)} \leq \frac{k_{n+1}}{k_{n+1} + l_{n+1}}.$$

Since  $\frac{l_i}{k_i} \geq \frac{l_{i+1}}{k_{i+1}}$  for any  $i \in [n]$ ,  $\frac{k_i}{l_i + k_i} \leq \frac{k_{i+1}}{k_{i+1} + l_{i+1}}$  for any  $i \in [n]$ . Thus,  $\frac{k_{n+1}}{k_{n+1} + l_{n+1}} \geq \frac{k_{i+1}}{k_{i+1} + l_{i+1}}$  for any  $i \in [n]$ . Let  $\alpha = \frac{k_{n+1}}{k_{n+1} + l_{n+1}}$ ; we have

$$\frac{k_{\leq n+1}}{\sum_{i \in [n+1]} (k_i + l_i)} = \frac{\sum_{i \in [n+1]} k_i}{\sum_{i \in [n+1]} (k_i + l_i)} \leq \frac{\sum_{i \in [n+1]} \alpha (k_i + l_i)}{\sum_{i \in [n+1]} (k_i + l_i)} = \alpha = \frac{k_{n+1}}{k_{n+1} + l_{n+1}}.$$

$\square$

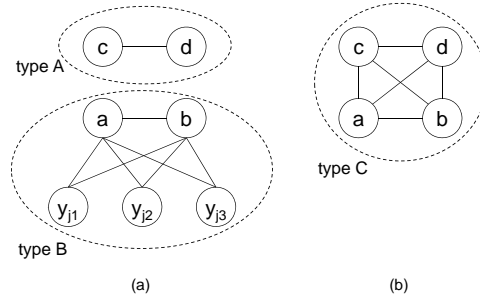

Figure 7: (a) Coalitions corresponding to a set belonging to the exact 3-cover. (b) Coalition corresponding to a set not belonging to the exact 3-cover.

## Appendix D. Proofs from Section 5

### D.1 Proof of Theorem 14

*Proof.* We prove the claim by exploiting a reduction from the *Exact 3-Cover* problem which is well known to be NP-hard (Garey & Johnson, 1990). In this problem, we are given a universe  $X = [3p]$  of  $3p$  elements and a collection  $\mathcal{B} = \{B_1 \dots, B_m\}$  of  $m$  subsets of  $X$  such that  $|B_j| = 3$  for any  $1 \leq j \leq m$  and  $\bigcup_{j=1}^m B_j = X$ . The objective is to find a collection of  $p$  subsets  $\mathcal{F} = \{B_{i_1}, \dots, B_{i_p}\} \subseteq \mathcal{B}$  such that  $\bigcup_{j=1}^p B_{i_j} = X$ .

Given an instance  $(X, \mathcal{B})$  of Exact 3-Cover, we can construct an undirected graph  $G$  in the following way.  $G$  has node set  $N = N_1 \cup N_2$  and edge set  $E = E_1 \cup E_2$ , where  $N_1 = \{a_j, b_j, c_j, d_j \mid j = 1, \dots, m\}$ ,  $N_2 = \{y_j \mid j = 1, \dots, 3p\}$ ,  $E_1 = \{\{a_j, b_j\}, \{a_j, c_j\}, \{a_j, d_j\}, \{b_j, c_j\}, \{b_j, d_j\}, \{c_j, d_j\} \mid j = 1, \dots, m\}$  and  $E_2 = \{\{y_i, a_j\}, \{y_i, b_j\} \mid i \in B_j\}$ .

In other words, for each subset in  $\mathcal{B}$  there is a clique of 4 nodes whose nodes belong to  $N_1$  and whose edges belong to  $E_1$ , and for each element in  $X$  there is a node belonging to  $N_2$ ;  $E_2$  contains edges connecting a node  $y_i$  of  $N_2$  to nodes  $a_j$  and  $b_j$  in  $N_1$  if and only if  $i \in B_j$ . Note that  $G$  is connected and unweighted.

In the following, we show that there exists an exact 3-cover for  $(X, \mathcal{B})$  if and only if the social optimum of  $\mathcal{G}(G)$  has social welfare at least  $\frac{19}{5}p + 3(m - p)$ , and that if an exact 3-cover exists, a Nash stable coalition structure of social welfare  $\frac{19}{5}p + 3(m - p)$  also exists, thus proving the claim.

If there exists an exact 3-cover for  $(X, \mathcal{B})$ , then there exists a coalition structure of social welfare equal to  $\frac{19}{5}p + 3(m - p)$ . In fact, let  $B_{i_1}^*, \dots, B_{i_p}^*$  be the exact 3-cover; consider the coalition structure composed by the following  $m$  non-empty sets: For each  $k = 1, \dots, p$ , add the two coalitions  $\{c_{i_k}^*, d_{i_k}^*\}$  (of type A) and  $\{y_j \mid j \in B_{i_k}^*\} \cup \{a_{i_k}^*, b_{i_k}^*\}$  (of type B) of total social welfare  $\frac{19}{5}$  (see Figure 7(a)); furthermore, for any  $j$  in  $[m] \setminus \{i_1^*, \dots, i_p^*\}$ , add the coalition composed by nodes  $a_j, b_j, c_j, d_j$  (of type C), inducing a clique and having social welfare equal to 3 (see Figure 7(b)). It can be easily verified that this coalition structure is Nash stable:

- nodes  $c$  and  $d$  in a coalition of type A are stable because their payoff is  $\frac{1}{2}$  and by joining the coalition of type B corresponding to the same set  $B_i$  their payoff would become  $\frac{1}{3}$ .
- nodes  $a$  and  $b$  in a coalition of type B are stable because their payoff is  $\frac{4}{5}$  and by joining the coalition of type A corresponding to the same set  $B_i$  their payoff would become  $\frac{2}{3}$ .
- nodes  $y$  in a coalition of type B are stable because their payoff is  $\frac{2}{5}$  and by joining the coalition of type C corresponding to another set  $B_i$  containing the element corresponding to node  $y$ , their payoff would remain equal to  $\frac{2}{5}$ .
- nodes  $c$  and  $d$  in a coalition of type C are clearly stable.
- nodes  $a$  and  $b$  in a coalition of type C are stable because their payoff is  $\frac{3}{4}$  and by joining the coalition of type B corresponding to another set  $B_i$  their payoff would be at most  $\frac{1}{3}$ .

Conversely, if no exact 3-cover exists, then the social optimum has a social welfare strictly smaller than  $\frac{19}{5}p + 3(m - p)$ . Given a coalition structure  $\mathbf{C}$ , we say that  $\mathbf{C}$  assigns element  $j$  ( $j = 1, \dots, 3p$ ) to set  $B_i$  ( $i = 1, \dots, m$ ) if  $\mathbf{C}(y_j) = \mathbf{C}(a_i)$  or  $\mathbf{C}(y_j) = \mathbf{C}(b_i)$  (or both). In the following, we exploit the following property:

**Property 8.** *Given any coalition structure  $\mathbf{C}$ , there exists another coalition structure  $\mathbf{C}'$  such that  $\text{SW}(\mathbf{C}') \geq \text{SW}(\mathbf{C})$  and, for any  $j = 1, \dots, 3p$ ,  $\mathbf{C}'$  assigns element  $j$  only to one set  $B_i$ .*

Given Property 8, we can focus on the class of coalition structures assigning each element to a unique set. Therefore, given any coalition structure  $\mathbf{C}$  in this class, we have to distinguish among four cases, depending on the number  $k$  ( $k = 0, 1, 2, 3$ ) of elements  $\mathbf{C}$  assigns to a set  $B_i$ . Consider a generic set  $B_i$  and its associated nodes  $a_i, b_i, c_i, d_i$ . It can be easily checked by a case analysis that the highest possible social welfare relative to the coalitions containing  $a_i, b_i, c_i, d_i$  and the nodes corresponding to the elements  $\mathbf{C}$  assigns to  $B_i$  is as follows:

- if  $k = 0$ , the highest possible social welfare is 3 and is obtained by considering a unique coalition containing all the four nodes (see Figure 8(a));
- if  $k = 1$ , letting  $y_j$  be the element assigned by  $\mathbf{C}$  to  $B_i$ , the highest possible social welfare is  $\frac{16}{5}$  and is obtained by considering a unique coalition containing all the five nodes (see Figure 8(b));
- if  $k = 2$ , letting  $y_{j_1}$  and  $y_{j_2}$  be the elements assigned by  $\mathbf{C}$  to  $B_i$ , the highest possible social welfare is  $\frac{7}{2}$  and is obtained by considering the two coalitions  $\{c_i, d_i\}$  and  $\{a_i, b_i, y_{j_1}, y_{j_2}\}$  (see Figure 8(c));
- if  $k = 3$ , letting  $y_{j_1}, y_{j_2}$  and  $y_{j_3}$  be the elements assigned by  $\mathbf{C}$  to  $B_i$ , the highest possible social welfare is  $\frac{19}{5}$  and is obtained by considering the two coalitions  $\{c_i, d_i\}$  and  $\{a_i, b_i, y_{j_1}, y_{j_2}, y_{j_3}\}$  (see Figure 8(d)).

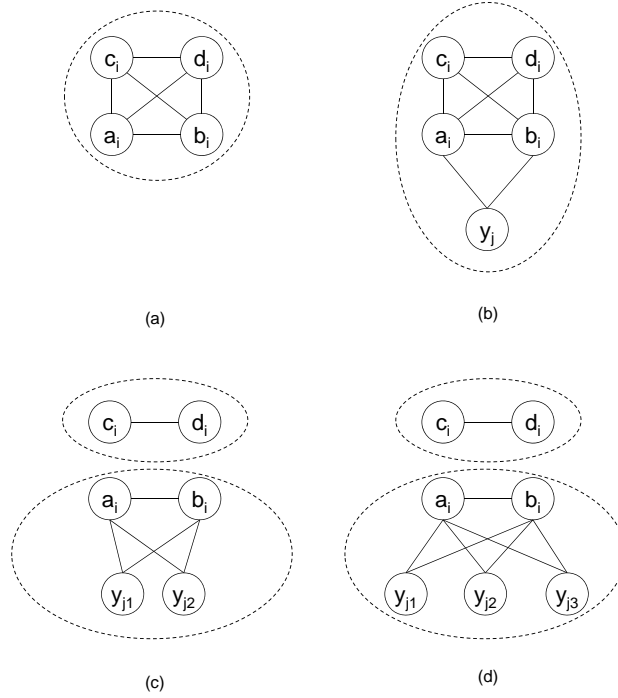

Figure 8: Coalition structures with the highest possible social welfare for (a)  $k = 0$ ; (b)  $k = 1$ ; (c)  $k = 2$ ; (d)  $k = 3$ .

For each  $i = 1, \dots, m$ , we rearrange the social welfare of the above coalition structure configurations such that 3 is always accounted to the nodes  $a_i, b_i, c_i, d_i$  and the surplus is equally shared among the nodes in  $N_2$  that  $\mathbf{C}$  assigns to  $B_i$ . Therefore, if  $k = 1$  and  $y_j \in N_2$  is the element assigned by  $\mathbf{C}$  to  $B_i$ , we account  $\frac{16}{5} - 3 = \frac{1}{5}$  to  $y_j$ ; if  $k = 2$  and  $y_{j_1}, y_{j_2} \in N_2$  are the elements assigned by  $\mathbf{C}$  to  $B_i$ , we account  $\frac{7-3}{2} = \frac{1}{4}$  to  $y_{j_1}$  and  $y_{j_2}$ ; if  $k = 3$  and  $y_{j_1}, y_{j_2}, y_{j_3} \in N_2$  are the elements assigned by  $\mathbf{C}$  to  $B_i$ , we account  $\frac{\frac{19}{5}-3}{3} = \frac{4}{15}$  to  $y_{j_1}, y_{j_2}$  and  $y_{j_3}$ . Notice that, since  $\frac{4}{15} > \frac{1}{4} > \frac{1}{5}$ , a coalition structure with social welfare equal to  $3p \cdot \frac{4}{15} + 3m = \frac{19}{5}p + 3(m-p)$  can be obtained if and only if  $\frac{4}{15}$  is accounted to all nodes in  $N_2$ ; therefore, also recalling Property 8, this would imply that an exact 3-cover exists: a contradiction.

In order to complete the proof, we have to prove Property 8. Consider a coalition structure  $\mathbf{C}$ ; first of all, we can assume that each coalition in  $\mathbf{C}$  is connected, otherwise it could be split into two or more coalitions with a higher total social welfare. Consider also a set  $B_i$  with its corresponding nodes  $\{a_i, b_i, c_i, d_i\} \in N_1$ . Let us assume that there exists a coalition  $C \in \mathbf{C}$  containing both (at least) a node in  $\{a_i, b_i, c_i, d_i\}$  and (at least) a node in  $\{a_j, b_j, c_j, d_j | j \neq i\}$ . We show that  $\mathbf{C}$  can be transformed into a new coalition structure  $\mathbf{C}'$  so that  $\text{SW}(\mathbf{C}') \geq \text{SW}(\mathbf{C})$  and  $\mathbf{C}'(u) \neq \mathbf{C}'(v)$  for any  $u \in \{a_i, b_i, c_i, d_i\}$  and  $v \in \{a_j, b_j, c_j, d_j | j \neq i\}$ . Since a coalition can contain nodes corresponding to two different

sets  $B_i$  and  $B_j$  only if (at least) an element to be covered is assigned both to  $B_i$  and  $B_j$ , such a process can be iterated until Property 8 holds.

Let  $y_{i_1}, y_{i_2}, y_{i_3}$  be the nodes in  $N_2$  such that  $i_1, i_2, i_3 \in B_i$ . Roughly speaking, the idea is that of reducing coalition  $C$  so that all nodes in  $\{a_i, b_i, c_i, d_i\} \cap C$  are removed from  $C$ , whilst all other nodes of  $C$  (including those in  $\{y_{i_1}, y_{i_2}, y_{i_3}\} \cap C$ ) remain in  $C$ ; therefore,  $C$  is replaced by  $C' = C \setminus \{a_i, b_i, c_i, d_i\}$  and  $\mathbf{C}' = \mathbf{C} \setminus \{C\} \cup \{C'\}$ . Furthermore, a new coalition  $C'' = \{a_i, b_i, c_i, d_i\}$  is added to  $\mathbf{C}'$ . We aim at proving that  $\text{SW}(\mathbf{C}') \geq \text{SW}(\mathbf{C})$ .

Actually, the transformation of  $\mathbf{C}$  into  $\mathbf{C}'$  does not take place as described above in all cases. In the following, we refer to the one above described as the *standard* transformation.

We have to distinguish between two disjoint cases:

- If  $\mathbf{C}(a_i) = \mathbf{C}(b_i) = C$ , we apply the standard transformation of  $\mathbf{C}$  into  $\mathbf{C}'$ . Since  $|C'| \leq |C|$ ,  $\text{SW}(C) - \text{SW}(C') = \frac{2|E_C|}{|C|} - \frac{2|E_{C'}|}{|C'|} \leq \frac{2(|E_C| - |E_{C'}|)}{|C|}$ . Moreover,  $\text{SW}(C'') = 3$ .

Let  $\alpha = |\{c_i, d_i\} \cap C|$  and  $\beta = |\{y_{i_1}, y_{i_2}, y_{i_3}\} \cap C|$ ; then,  $|E_C| - |E_{C'}| = \frac{(\alpha+1)(\alpha+2)}{2} + 2\beta$  and  $|C| \geq \alpha + \beta + 3$  (because, by the choice of  $C$ , at least one node not belonging to  $\{a_i, b_i, c_i, d_i, y_{i_1}, y_{i_2}, y_{i_3}\}$  has to belong to  $C$ ).

Notice that, if  $\alpha > 0$ ,  $\text{SW}(\mathbf{C}') - \text{SW}(\mathbf{C}) = \text{SW}(C') + \text{SW}(C'') - \text{SW}(C) = 3 + \text{SW}(C') - \text{SW}(C)$ . If  $\alpha = 0$  we have to take into account that also another coalition  $\{c_i, d_i\}$  with social welfare 1 could belong to  $\mathbf{C}$  and has to be removed in order to obtain coalition  $C'' \in \mathbf{C}'$ ; therefore,  $\text{SW}(\mathbf{C}') - \text{SW}(\mathbf{C}) = \text{SW}(C') + \text{SW}(C'') - (\text{SW}(\{c_i, d_i\}) + \text{SW}(C)) = 2 + \text{SW}(C') - \text{SW}(C)$ .

Therefore, if  $\alpha > 0$  we have to verify that

$$3 \geq \frac{(\alpha + 1)(\alpha + 2) + 4\beta}{\alpha + \beta + 3},$$

and if  $\alpha = 0$  we have to verify that

$$2 \geq \frac{2 + 4\beta}{\beta + 3}. \quad (10)$$

The above inequalities are verified for all values of  $0 \leq \alpha \leq 2$  and  $1 \leq \beta \leq 3$ , but the combination  $\alpha = 0$  and  $\beta = 3$ .

In this case, if  $|C| \geq 7$ , i.e., there exist at least 2 nodes in  $C$  not belonging to  $\{a_i, b_i, c_i, d_i, y_{i_1}, y_{i_2}, y_{i_3}\}$ , the denominator at the right-hand side of 10 becomes 7 and the equation is verified for  $\beta = 3$ . It remains to deal with the case in which  $\alpha = 0$ ,  $\beta = 3$  and  $|C| = 6$  (see Figure 9(a)). Notice that in this case it is not possible that all the three nodes  $y_{i_1}, y_{i_2}, y_{i_3}$  have an edge toward node  $x$  because we can assume that in the Exact 3 Cover instance  $B_i \neq B_j$  for  $i \neq j$ ; therefore, there must exist a node, say  $y_{i_1}$  not adjacent to node  $x$ , and  $\text{SW}(C) \leq 3$ . In this case, we do not apply the standard transformation: as shown in Figure 9(b), we split  $C$  in two coalitions of total social welfare  $\frac{5}{2} + 1 > 3$ .

- If  $\mathbf{C}(a_i) \neq \mathbf{C}(b_i)$  and only one of them, say without loss of generality  $\mathbf{C}(a_i) = C$ , we have to extend the standard transformation by taking into account also coalition  $\bar{C} = \mathbf{C}(b_i)$ .



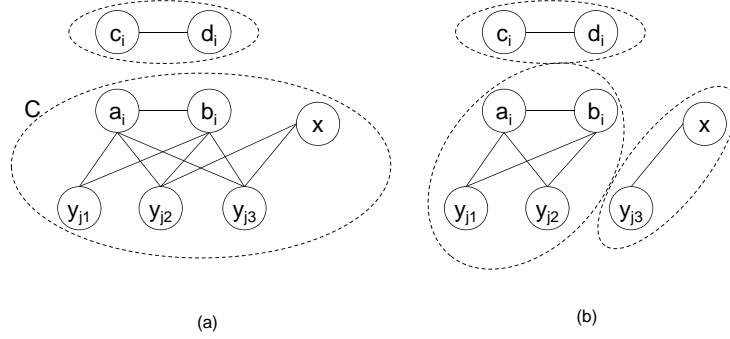

Figure 9: The new coalition structure  $\mathbf{C}'$  in the case of  $\alpha = 0$ ,  $\beta = 3$  and  $|C| = 6$ .

In particular,  $C$  is replaced by  $C' = C \setminus \{a_i, b_i, c_i, d_i\}$ ,  $\bar{C}$  by  $\bar{C}' = \bar{C} \setminus \{a_i, b_i, c_i, d_i\}$ . Furthermore, a new coalition  $C'' = \{a_i, b_i, c_i, d_i\}$  is added to  $\mathbf{C}'$ .

Analogously to the previous case,  $\text{SW}(C) - \text{SW}(C') \leq \frac{2(|E_C| - |E_{C'}|)}{|C|}$  and  $\text{SW}(\bar{C}) - \text{SW}(\bar{C}') \leq \frac{2(|E_{\bar{C}}| - |E_{\bar{C}'}|)}{|\bar{C}|}$ . Moreover,  $\text{SW}(C'') = 3$ .

Let  $\alpha = |\{c_i, d_i\} \cap C|$ ,  $\beta = |\{y_{i_1}, y_{i_2}, y_{i_3}\} \cap C|$ ,  $\bar{\alpha} = |\{c_i, d_i\} \cap \bar{C}|$  and  $\bar{\beta} = |\{y_{i_1}, y_{i_2}, y_{i_3}\} \cap \bar{C}|$ ; then,  $|E_C| - |E_{C'}| = \frac{\alpha(\alpha+1)}{2} + \beta$ ,  $|E_{\bar{C}}| - |E_{\bar{C}'}| = \frac{\bar{\alpha}(\bar{\alpha}+1)}{2} + \bar{\beta}$ ,  $|C| \geq \alpha + \beta + 2$  (because, by the choice of  $C$ , at least one node not belonging to  $\{a_i, b_i, c_i, d_i, y_{i_1}, y_{i_2}, y_{i_3}\}$  has to belong to  $C$ ) and  $|\bar{C}| \geq \bar{\alpha} + \bar{\beta} + 1$ . Notice that, since a coalition structure is given by a partition of nodes into sets,  $\alpha + \bar{\alpha} \leq 2$  and  $\beta + \bar{\beta} \leq 3$ .

Notice that, if  $\alpha + \bar{\alpha} > 0$ ,  $\text{SW}(\mathbf{C}') - \text{SW}(\mathbf{C}) = \text{SW}(C') + \text{SW}(\bar{C}') + \text{SW}(C'') - (\text{SW}(C) + \text{SW}(\bar{C})) = 3 + (\text{SW}(C') - \text{SW}(C)) + (\text{SW}(\bar{C}') - \text{SW}(\bar{C}))$ . If  $\alpha + \bar{\alpha} = 0$  we have to take into account that also another coalition  $\{c_i, d_i\}$  with social welfare 1 could belong to  $\mathbf{C}$  and has to be removed in order to obtain coalition  $C'' \in \mathbf{C}'$ ; therefore,  $\text{SW}(\mathbf{C}') - \text{SW}(\mathbf{C}) = \text{SW}(C') + \text{SW}(\bar{C}') + \text{SW}(C'') - (\text{SW}(\{c_i, d_i\}) + \text{SW}(C) + \text{SW}(\bar{C})) = 2 + (\text{SW}(C') - \text{SW}(C)) + (\text{SW}(\bar{C}') - \text{SW}(\bar{C}))$ .

Therefore, if  $\alpha + \bar{\alpha} > 0$  we have to verify that

$$3 \geq \frac{\alpha(\alpha+1) + 2\beta}{\alpha + \beta + 2} + \frac{\bar{\alpha}(\bar{\alpha}+1) + 2\bar{\beta}}{\bar{\alpha} + \bar{\beta} + 1}, \quad (11)$$

and if  $\alpha + \bar{\alpha} = 0$  we have to verify that

$$2 \geq \frac{2\beta}{\beta + 2} + \frac{2\bar{\beta}}{\bar{\beta} + 1}.$$

The above inequalities are verified for all values of  $0 \leq \alpha \leq 2$ ,  $0 \leq \bar{\alpha} \leq 2$ ,  $1 \leq \beta \leq 3$  and  $0 \leq \bar{\beta} \leq 3$  with constraints  $\alpha + \bar{\alpha} \leq 2$  and  $\beta + \bar{\beta} \leq 3$ , but the combination  $\alpha = 0$ ,  $\bar{\alpha} = 2$ ,  $\beta = 3$  and  $\bar{\beta} = 0$ .

In this case, if  $|C| \geq 6$ , i.e., there exist at least 2 nodes in  $C$  not belonging to  $\{a_i, b_i, c_i, d_i, y_{i_1}, y_{i_2}, y_{i_3}\}$ , the first denominator at the right side of 11 becomes 6 and the equation is verified for  $\alpha = 0$ ,  $\bar{\alpha} = 2$ ,  $\beta = 3$  and  $\bar{\beta} = 0$ :  $3 \geq \frac{6}{6} + \frac{6}{3}$ .

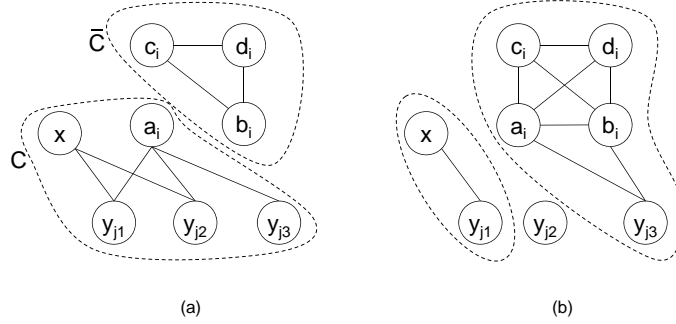

Figure 10: The new coalition structure  $\mathbf{C}'$  in the case of  $\alpha = 0$ ,  $\beta = 3$  and  $|C| = 6$ .

It remains to deal with the case in which  $\alpha = 0$ ,  $\bar{\alpha} = 2$ ,  $\beta = 3$ ,  $\bar{\beta} = 0$  and  $|C| = 5$  (see Figure 10(a)). Notice that in this case it is not possible that all the three nodes  $y_{i_1}, y_{i_2}, y_{i_3}$  have an edge toward node  $x$  because we can assume that in the *Exact 3-Cover* instance  $B_i \neq B_j$  for  $i \neq j$ ; therefore, there must exist a node, say  $y_{i_3}$ , not adjacent to node  $x$ , and, clearly, at least a node, say  $y_{i_1}$ , being adjacent to node  $x$ ; it follows that  $\text{SW}(C) \leq 2$  and  $\text{SW}(\bar{C}) = 2$ . In this case, we apply the transformation shown in Figure 10(b): we obtain two coalitions of total social welfare  $1 + \frac{16}{5} > 4$ .  $\square$

## Appendix E. Proofs from Subsection 5.3

### E.1 Proof of Lemma 14

*Proof.* Let  $\mathbf{C}^*$  be a social optimum and  $g$  be a labeling compatible with  $\mathbf{C}^*$ . Let us first notice that, by Remark 1, if there is a coalition  $C_i^* = \{u, v\}$  with only two agents, then there is another labeling  $g'$  compatible with  $\mathbf{C}^*$  obtained from  $g$  by swapping the labels of the two agents in  $C_i^*$ , that is  $g'(u) = g(v)$ ,  $g'(v) = g(u)$  and  $g'(w) = g(w)$  for every  $w \neq u, v$ . For this reason, among all the functions compatible with  $\mathbf{C}^*$ , we take into account only the one that, for each coalition having only two agents, labels as **External** the agent closer to the root  $r$ . We refer to such a function as *super-compatible (with respect to  $r$ )* which is formally defined as follows:  $g$  is super-compatible with  $\mathbf{C}^*$  (with respect to  $r$ ) if  $g$  is compatible with  $\mathbf{C}^*$  and for every  $C_i^* = \{u_i, v_i\}$ , with  $u_i = \text{Parent}_r(G, v_i)$  we have  $g(u_i) = \text{Internal}$ ,  $g(v_i) = \text{External}$ .

Let  $g$  be a labeling which is super-compatible with an optimal coalition structure  $\mathbf{C}^*$ . We want to show that  $g$  is equivalent to  $f$ ; if not then there exists another labeling function  $\bar{g}$  which is super-compatible with a different optimal coalition structure  $\bar{\mathbf{C}}^*$  and is equivalent to  $f$ . The proof is by induction on the level of the tree rooted at  $r$ . In the reminder of this proof we frequently make use of Remark 1, and the property from Lemma 13 stating that every coalition of a social optimum contains at least two agents.

Let  $u \in \text{Leaves}_r(G)$ . We have  $f(u) = \text{External}$ . Let us assume  $g(u) = \text{Internal}$ . As consequence of Lemma 13,  $|\mathbf{C}^*(u)| \geq 2$ , thus  $v = \text{Parent}_r(G, u) \in \mathbf{C}^*(u)$ . From Remark 1, since  $u$  in an internal agent, no other internal agent can be a member of  $\mathbf{C}^*(u)$ , thus

$g(v) = \text{External}$ . Moreover from Remark 1, any additional agent in  $\mathbf{C}^*(u)$  beside  $u$  and  $v$  should be an external agent not adjacent to  $v$ , hence  $v$  is the only external agent in  $\mathbf{C}^*(u)$ , i.e.,  $\mathbf{C}^*(u) = \{u, v\}$ . This contradicts that  $g$  is super-compatible with  $\mathbf{C}^*$ .

For the inductive step, let us assume that  $g$  is equivalent to  $f$  on every agent at a level strictly larger than  $l$ , and let us prove that  $g(u) = f(u)$  for every agent  $u$  at level  $l$ . Let  $u$  be such that  $\text{Level}_r(G, u) = l$ .

**Case 1.** If  $\forall x \in \text{Children}_r(G, u)$  we have  $f(x) = \text{Internal}$ , then  $f(u) = \text{External}$ . By way of contradiction, let us assume  $g(u) = \text{Internal}$ . From Remark 1, since  $u$  is an internal agent, no other internal agent can be a member of  $\mathbf{C}^*(u)$ , thus no children of  $u$  is in  $\mathbf{C}^*(u)$ . Applying the same argument of the base of the induction, let  $v = \text{Parent}_r(G, u)$ ,  $\mathbf{C}^*(u) = \{u, v\}$  and  $g(v) = \text{External}$ . Thus a contradiction.

**Case 2.** If  $\forall x \in \text{Children}_r(G, u)$  we have  $f(x) = \text{External}$ , then  $f(u) = \text{Internal}$ . By way of contradiction, let us assume  $g(u) = \text{External}$ . From Remark 1, since  $u$  is an external agent, no other external agent which is adjacent to  $u$  can be a member of  $\mathbf{C}^*(u)$ , thus no children of  $u$  is in  $\mathbf{C}^*(u)$ . From Lemma 13,  $|\mathbf{C}^*(u)| \geq 2$ , thus  $v = \text{Parent}_r(G, u) \in \mathbf{C}^*(u)$ . By Remark 1, since  $u$  is an external agent, it must be  $g(v) = \text{Internal}$ . Let us distinguish two subcases:

- (a)  $\mathbf{C}^*(u) = \{u, v\}$ ;
- (b)  $|\mathbf{C}^*(u)| \geq 3$ , thus  $\exists w \in \mathbf{C}^*(u), w \neq u, v$ .

Fix  $x \in \text{Children}_r(G, u)$ . Let us first observe that  $|\mathbf{C}^*(x)| \geq 3$ . In fact, from Lemma 13,  $|\mathbf{C}^*(x)| \geq 2$ , thus  $\exists y \in \text{Children}_r(G, x)$  such that  $y \in \mathbf{C}^*(x)$ . By Remark 1 and the induction hypothesis, since  $x$  is an external agent, it must be  $g(y) = \text{Internal}$ . Since  $g$  is super-compatible with  $\mathbf{C}^*$ , there must exist  $z \in \text{Children}_r(G, y)$  such that  $z \in \mathbf{C}^*(y) = \mathbf{C}^*(x)$ .

For (a), we define  $\bar{\mathbf{C}}^*$  to be the coalition structure obtained from  $\mathbf{C}^*$  by replacing  $\mathbf{C}^*(u)$  and  $\mathbf{C}^*(x)$  with  $\{v, u, x\}$  and  $\mathbf{C}^*(x) \setminus \{x\}$ , and we choose  $\bar{g}$  such that  $\bar{g}(s) = g(s)$  for every  $s \neq u, v$ ,  $\bar{g}(u) = \text{Internal}$ ,  $\bar{g}(v) = \text{External}$ . It is easy to verify that  $\text{SW}(\bar{\mathbf{C}}^*) \geq \text{SW}(\mathbf{C}^*)$  and  $\bar{g}$  is super-compatible with  $\bar{\mathbf{C}}^*$ . In particular, if  $\text{SW}(\bar{\mathbf{C}}^*) = \text{SW}(\mathbf{C}^*)$ , we have found an alternative social optimum  $\bar{\mathbf{C}}^*$  and an alternative labeling  $\bar{g}$  which is super-compatible with  $\bar{\mathbf{C}}^*$  and equivalent to  $f$ ; if  $\text{SW}(\bar{\mathbf{C}}^*) > \text{SW}(\mathbf{C}^*)$ , it is contradicted that  $\mathbf{C}^*$  is the social optimum.

For (b), first of all notice that, by Remark 1,  $w \in \text{Children}_r(G, v)$  because  $g(u) = \text{External}$ ; we define  $\bar{\mathbf{C}}^*$  to be the coalition structure obtained from  $\mathbf{C}^*$  by replacing  $\mathbf{C}^*(u)$  and  $\mathbf{C}^*(x)$  with the three coalitions  $\{v, w\}$ ,  $\{u, x\}$  and  $\mathbf{C}^*(x) \setminus \{x\}$ . It is easy to verify that  $\text{SW}(\bar{\mathbf{C}}^*) > \text{SW}(\mathbf{C}^*)$ : this contradicts that  $\mathbf{C}^*$  is the social optimum.

**Case 3.** If  $\exists x_1, x_2 \in \text{Children}_r(G, u)$  such that  $f(x_1) = \text{External}$ ,  $f(x_2) = \text{Internal}$ , then  $f(u) = \text{Internal}$ . By way of contradiction, let us assume  $g(u) = \text{External}$ . Differently from the previous case in which all the children of  $u$  are external agents,  $x_2$  may be a member of  $\mathbf{C}^*(u)$ . If for any  $x \in \text{Children}_r(G, u)$  such that  $f(x) = \text{Internal}$  (including  $x_2$ ) it holds that  $x \notin \mathbf{C}^*(u)$ , then it is possible to apply the same arguments as for **Case 2**.

Conversely, if  $x_2 \in \mathbf{C}^*(u)$ , it holds that (i) by Remark 1  $x_1 \notin \mathbf{C}^*(u)$  and (ii) since from the hypothesis  $g$  is super-compatible with  $\mathbf{C}^*$ , there must exist  $y_2 \in \text{Children}_r(G, x_2)$  such that  $y_2 \in \mathbf{C}^*(x_2) = \mathbf{C}^*(u)$ . Let  $y_1 \in \text{Children}_r(G, x_1)$ ; notice that, again by Remark 1 and by the induction hypothesis, since  $f(x_1) = g(x_1) = \text{External}$ , it holds that  $f(y_1) = g(y_1) = \text{Internal}$ . Moreover, since  $g$  is super-compatible with  $\mathbf{C}^*$ , there must exist at least a node  $z \in \text{Children}_r(G, y_1)$  and therefore  $|\mathbf{C}^*(x)| \geq 3$ . In this case we define  $\bar{\mathbf{C}}^*$  to be the coalition structure obtained from  $\mathbf{C}^*$  by replacing  $\mathbf{C}^*(u)$  and  $\mathbf{C}^*(x_1)$  with the three coalitions  $\{u, x_1\}$ ,  $\mathbf{C}^*(x) \setminus \{x\}$  and  $\mathbf{C}^*(u) \setminus \{u\}$ . It is easy to verify that  $\text{SW}(\bar{\mathbf{C}}^*) > \text{SW}(\mathbf{C}^*)$ . This again contradicts that  $\mathbf{C}^*$  is the social optimum.  $\square$

## E.2 Proof of Lemma 15

*Proof.* Let us prove the claim by induction on the height of the subtree  $G_{T_u^s}$  rooted at  $u$ . If the height of the tree is 1, the claim trivially holds since the subtree has no alternating path.

Let us assume that the lemma holds for any value of the height strictly smaller than  $l \geq 2$ , and let us show that it works also when the height is equal to  $l$ . Hence, let us assume that the tree  $G_{T_u^s}$  rooted at  $u$  has height equal to  $l$ . Let  $\mathbf{C}' = \{\mathbf{C}'(x)\}_{x:g(x)=\text{Internal}}$  be the coalition structure at the end of line 16. By the inductive hypothesis, we have that for every internal agent  $x \in T_{w_i^*}^s$ , for  $i \in [1, k]$ , every alternating path with respect to  $\mathbf{C}'$  and starting at  $x$  is ordered. Notice that the size of the coalitions of the internal agents in  $T_{w_i^*}^s$  could be changed only by the call of `OPTCS_EXT`, [line 23]. Let  $\mathbf{C}'' = \{\mathbf{C}''(x)\}_{x:g(x)=\text{Internal}}$  be the coalition structure at the end of line 23, right after the call of `OPTCS_EXT`. After the execution of `OPTCS_EXT` only one coalition changes its size (by increasing it by one unit); let  $\mathbf{C}''(z)$ , with  $z \in T_{w_i^*}^s$  being internal, be this coalition, i.e.,  $|\mathbf{C}''(z)| = |\mathbf{C}'(z)| + 1$ . From the condition of the **if** statement at line 3 in procedure `ORDER`, it follows that every alternating pair (with respect to  $\mathbf{C}''$ ) starting at  $z$  is ordered. Finally, we only need to show that  $|\mathbf{C}(u)| \leq |\mathbf{C}(w_i^*)|$ , for every  $i \in [1, k]$ . But this is guaranteed by the condition of the **while** loop, [line 17], and the fact that the coalitions  $|\mathbf{C}(w_i^*)|$ , for  $i \in [1, k]$ , are ordered according to size in non-decreasing way.  $\square$

## E.3 Proof of Lemma 16

*Proof.* Define  $\text{Children}_s(G, v) = \{w_1, \dots, w_k\}$  (notice that all these nodes are internal); notice that when procedure `OPTCS_EXT` is called with parameter  $v$ , the social optimum for every subgame  $\mathcal{G}(G_{T_{w_j}^s})$  ( $j = 1, \dots, k$ ) has been already computed (at lines 10-12 of Algorithm 2 or at lines 8-11 of Procedure `OPTCS_INT`); let  $\mathbf{C}' = \{\mathbf{C}'(x)\}_{x:g(x)=\text{Internal}}$  be the snapshot of this social optimum. Then,  $w \in \arg \min_{w_j \in \text{Children}_s(G, v)} |\mathbf{C}'(w_j)|$ . Furthermore, let  $\mathbf{C}'_j = \{\mathbf{C}'(x)\}_{x \in T_{w_j}^s: g(x)=\text{Internal}}$  (for every  $j = 1, \dots, k$ ).

Let  $\text{Opt}(\mathcal{G}(G_{T_v^s}))$  be the social welfare of any social optimum for  $\mathcal{G}(G_{T_v^s})$ . For every  $j \in [k]$ , let  $X_j$  be the set  $\{v\} \cup T_{w_j}^s$ , and let  $\mathcal{H}(j) = \text{Opt}(\mathcal{G}(G_{X_j})) + \text{Opt}(\mathcal{G}(G_{T_v^s \setminus X_j}))$ . It is easy to see that  $\text{Opt}(\mathcal{G}(G_{T_v^s})) = \max_{j \in [k]} \mathcal{H}(j)$ . Since  $T_v^s \setminus X_j$  can be partitioned into disjoint sets, we have that  $\text{Opt}(\mathcal{G}(G_{T_v^s \setminus X_j})) = \sum_{j' \in [k] \wedge (j' \neq j)} \text{Opt}(\mathcal{G}(G_{T_{w_{j'}}^s}))$ .

We now focus on the computation of  $\text{Opt}(\mathcal{G}(G_{X_j}))$ . Notice that the social optimum for  $\mathcal{G}(G_{X_j})$  has a social welfare at most equal to the one of the coalition structure obtained by adding one more agent to one of the coalitions of smallest size in  $\mathbf{C}'_j$ .

Procedure ORDER reassigns the agents to the coalitions in  $\mathbf{C}'_j$  in such a way that only the size of one of the smallest coalitions, among the ones reachable by an alternating path from  $w_j$ , is increased by one unit. In fact, by applying Lemma 15 to  $\mathbf{C}'_j$ , we know that for every internal agent  $x \in T_{w_j}^s$ , every alternating path with respect to  $\mathbf{C}'_j$  and starting at  $x$  is ordered. Let  $\mathbf{C}'' = \{\mathbf{C}''(x)\}_{x:g(x)=\text{Internal}}$  be the coalition structure right after the call of ORDER. After the execution of ORDER only one coalition increases its size by one unit; let  $\mathbf{C}''(z)$ , with  $z \in T_{w_j}^s$  being internal, be this coalition, i.e.,  $|\mathbf{C}''(z)| = |\mathbf{C}'(z)| + 1$ . From the definition of ORDER and Lemma 15,  $z$  is an agent reachable by an alternating path from  $w_j$  and  $|\mathbf{C}'(z)| = |\mathbf{C}'(w_j)|$ , that is,  $\mathbf{C}'(z)$  is one of the smallest coalition among all the ones reachable from  $w_j$  by an alternating path. It is worth noticing that, by procedure ORDER, even if node  $v_j$  is added to the coalition centered at  $w_j$ , the assignment of nodes to coalitions is rearranged so that the increase of one unit of cardinality concerns another coalition (coalition  $\mathbf{C}'(z)$ , say by adding to it node  $y$ ). Therefore, we obtain that

$$\begin{aligned} \text{Opt}(\mathcal{G}(G_{X_j})) - \text{Opt}(\mathcal{G}(G_{T_{w_j}^s})) &= \text{SW}(\mathbf{C}'(z) \cup \{y\}) - \text{SW}(\mathbf{C}'(z)) \\ &= \text{SW}(\mathbf{C}'(w_j) \cup \{v\}) - \text{SW}(\mathbf{C}'(w_j)) \end{aligned} \quad (12)$$

$$= \Delta(\mathbf{C}', w_j, v), \quad (13)$$

where equality 12 holds because  $|\mathbf{C}'(z)| = |\mathbf{C}'(w_j)|$ .

For any other coalition in  $\mathbf{C}'_j$  not reachable by an alternating path from  $w_j$ , given that  $g$  is an optimal labeling, it is clearly not possible to rearrange the assignment of agents to coalitions such that the increase of one unit of cardinality transfers to this coalition. We can conclude that  $\mathbf{C}''$  contains the social optimum for  $\mathcal{G}(G_{X_j})$ .

By equality 13 it follows that the index  $j$  maximizing  $\Delta(\mathbf{C}', w_j, v)$  also maximizes  $\mathcal{H}$ , i.e.,  $\arg \max_{j \in [k]} \mathcal{H}(j) = \arg \max_{j \in [k]} \Delta(\mathbf{C}', w_j, v)$ . The claim follows because the  $w$  selected at line 2 of OPTCS\_EXT belongs to  $\arg \min_{x \in \text{Children}_s(G, v)} |\mathbf{C}(x)|$ , and thus also belongs to  $\arg \max_{x \in \text{Children}_s(G, v)} \Delta(\mathbf{C}', x, v)$ .

We conclude the proof by observing that OPTCS\_EXT runs in a number of steps which is polynomial in the number of agents.  $\square$

#### E.4 Proof of Lemma 17

*Proof.* Let us prove the claim by induction on the height of the tree  $G_{T_u^s}$  rooted at  $u$ . If the height of the tree is 1, the procedure sets  $\mathbf{C}(u)$  equal to  $\{u\} \cup S_1$ , which is obviously the social optimum. Let us assume that OPTCS\_INT computes the social optimum of any game induced by a subtree with height strictly smaller than  $l \geq 2$ , and let us show that it works also when the height is equal to  $l$ . Hence, let us assume that the tree  $G_{T_u^s}$  rooted at  $u$  has height equal to  $l$ . Let  $\mathbf{C}' = \{\mathbf{C}'(x)\}_{x:g(x)=\text{Internal}}$  be the snapshot of the coalition structure obtained at the end of line 16 (before the beginning of the **while** loop). Notice that, by the inductive hypothesis,  $\mathbf{C}'_i$  is the social optimum for the subgame  $\mathcal{G}(G_{T_{w_i}^s})$ .

Let  $\text{Opt}(\mathcal{G}(G_{T_u^s}))$  be the social welfare of any social optimum for  $\mathcal{G}(G_{T_u^s})$ . For every  $P \subseteq S_2$ , let  $Y_P = T_u^s \setminus (\mathbf{C}'(u) \setminus P)$ . Notice that  $Y_P$  can be partitioned into disjoint sets, i.e.,  $Y_P =$

$\bigcup_{v_j \in P} T_{v_j}^s$ . For every  $P \subseteq S_2$ , we define  $\mathcal{F}(P) = \text{SW}(\mathbf{C}'(u) \setminus P) + \text{Opt}(\mathcal{G}(G_{Y_P}))$ . Since  $Y_P$  can be partitioned into disjoint sets, we trivially get that  $\text{Opt}(\mathcal{G}(G_{Y_P})) = \sum_{v_j \in P} \text{Opt}(\mathcal{G}(G_{T_{v_j}^s}))$ . It is easy to see that computing the social optimum for  $\mathcal{G}(G_{T_u^s})$  consists in identifying a subset  $P$  of  $S_2$  maximizing  $\mathcal{F}(P)$ , i.e.,  $\text{Opt}(\mathcal{G}(G_{T_u^s})) = \max_{P \subseteq S_2} \mathcal{F}(P)$ . The **while** loop, [lines 17 – 21], is devoted to the computation of such subset; it iteratively constructs the set  $Q$  as the set of the first  $h$  elements of  $S_2$  satisfying the condition at line 17, i.e.,  $Q = \{v_1, v_2, \dots, v_h\}$ . From the condition of the **while** loop, we deduce that  $h$  is such that, if  $Q \subset S_2$ , for every  $v_j$  with  $j > h$ ,  $|\mathbf{C}'(w_j^*)| > |\mathbf{C}'(u) \setminus Q| - 1$ . Hence, the social welfare of the coalition structure returned by `OPTCS_INT` for  $\mathcal{G}(G_{T_u^s})$  is  $\mathcal{F}(Q) = \text{SW}(\mathbf{C}'(u) \setminus Q) + \text{Opt}(\mathcal{G}(G_{Y_Q}))$ . Before proving that  $Q \in \arg \max_{P \subseteq S_2} \mathcal{F}(P)$ , we need to show how to compute the social optimum for  $\mathcal{G}(G_{Y_P})$ , for every  $P \subseteq S_2$ . Such coalition structure is obtained by the union of the social optima for the subgames  $\mathcal{G}(G_{T_{v_j}^s})$ , for every  $v_j \in P$ . The social optimum for  $\mathcal{G}(G_{T_{v_j}^s})$  can be computed by running the procedure `OPTCS_EXT` on input  $v_j$ , as claimed by Lemma 16.

It remains to show that  $Q \in \arg \max_{P \subseteq S_2} \mathcal{F}(P)$ . Recall that  $Q = \{v_1, v_2, \dots, v_h\}$  and, if  $Q \subset S_2$ , for every  $v_j$  with  $j > h$ , it holds that  $|\mathbf{C}'(w_j^*)| > |\mathbf{C}'(u) \setminus Q| - 1$ . By way of contradiction, let us assume that  $Q$  is not optimal, i.e., there is a subset  $R$  such that  $\mathcal{F}(R) > \mathcal{F}(Q)$ . If there exists an index  $j \geq 1$  such that  $v_j \notin R$  and  $v_{j+1} \in R$ , let  $R' = R \setminus \{v_{j+1}\} \cup \{v_j\}$ . Notice that, since  $|R'| = |R|$ ,  $\text{SW}(\mathbf{C}'(u) \setminus R') - \text{SW}(\mathbf{C}'(u) \setminus R) = 0$ . Moreover, by Lemma 16, we know that  $\text{Opt}(\mathcal{G}(G_{Y_{R'}})) - \text{Opt}(\mathcal{G}(G_{Y_R})) = \Delta(\mathbf{C}', w_j^*, v_j) - \Delta(\mathbf{C}', w_{j+1}^*, v_{j+1})$ . The two equalities imply that  $\mathcal{F}(R') - \mathcal{F}(R) = \Delta(\mathbf{C}', w_j^*, v_j) - \Delta(\mathbf{C}', w_{j+1}^*, v_{j+1})$ . Since  $|\mathbf{C}'(w_{j+1}^*)| \geq |\mathbf{C}'(w_j^*)|$ , it holds that  $\Delta(\mathbf{C}', w_j^*, v_j) - \Delta(\mathbf{C}', w_{j+1}^*, v_{j+1}) \geq 0$ , from which  $\mathcal{F}(R') \geq \mathcal{F}(R)$ . We can therefore assume that  $R$  contains agents  $v_j$  with consecutive indices, i.e., let  $R = \{v_1, v_2, \dots, v_{h'}\}$ . If  $h' > h$ , let  $R' = R \setminus \{v_{h'}\}$ . By applying Lemma 16, we obtain that  $\text{Opt}(\mathcal{G}(G_{Y_{R'}})) - \text{Opt}(\mathcal{G}(G_{Y_R})) = -\Delta(\mathbf{C}', w_{h'}^*, v_{h'})$ . Moreover, since  $h' > h$ , we have  $|\mathbf{C}'(u) \setminus R'| < |\mathbf{C}'(u) \setminus R| + 1$ , from which  $\text{SW}(\mathbf{C}'(u) \setminus R') - \text{SW}(\mathbf{C}'(u) \setminus R) > \Delta(\mathbf{C}', w_{h'}^*, v_{h'})$ . Hence, we obtain that  $\mathcal{F}(R') > \mathcal{F}(R)$ . Finally, let us assume that  $h' < h$ . Let  $R' = R \cup \{v_{h'+1}\}$ . By applying Lemma 16, we obtain that  $\text{Opt}(\mathcal{G}(G_{Y_{R'}})) - \text{Opt}(\mathcal{G}(G_{Y_R})) = \Delta(\mathbf{C}', w_{h'+1}^*, v_{h'+1})$ . Moreover, since  $h' < h$ , we have  $|\mathbf{C}'(u) \setminus R| \geq |\mathbf{C}'(u) \setminus R'| + 1$ , from which  $\text{SW}(\mathbf{C}'(u) \setminus R) - \text{SW}(\mathbf{C}'(u) \setminus R') < \Delta(\mathbf{C}', w_{h'+1}^*, v_{h'+1})$ . Hence, we obtain that  $\mathcal{F}(R') > \mathcal{F}(R)$ . We get a contradiction.  $\square$

## References

- Anshelevich, E., Dasgupta, A., Kleinberg, J., Tardos, E., Wexler, T., & Roughgarden, T. (2008). The price of stability for network design with fair cost allocation. *SIAM J. Comput.*, 38(4), 1602–1623.
- Apt, K. R., & Witzel, A. (2009). A generic approach to coalition formation. *International Game Theory Review*, 11(03), 347–367.
- Aziz, H., Brandt, F., & Harrenstein, P. (2013). Pareto optimality in coalition formation. *Games and Economic Behavior*, 82, 562 – 581.

- Aziz, H., Brandt, F., & Harrenstein, P. (2014). Fractional hedonic games. In *International conference on Autonomous Agents and Multi-Agent Systems, AAMAS '14, Paris, France, May 5-9, 2014*, pp. 5–12.
- Aziz, H., Brandt, F., & Seedig, H. G. (2011). Stable partitions in additively separable hedonic games. In *10th International Conference on Autonomous Agents and Multiagent Systems (AAMAS 2011), Taipei, Taiwan, May 2-6, 2011, Volume 1-3*, pp. 183–190.
- Aziz, H., & de Keijzer, B. (2011). Complexity of coalition structure generation. In *10th International Conference on Autonomous Agents and Multiagent Systems (AAMAS 2011), Taipei, Taiwan, May 2-6, 2011, Volume 1-3*, pp. 191–198.
- Aziz, H., Gaspers, S., Gudmundsson, J., Mestre, J., & Täubig, H. (2015). Welfare maximization in fractional hedonic games. In *Proceedings of the Twenty-Fourth International Joint Conference on Artificial Intelligence, IJCAI 2015, Buenos Aires, Argentina, July 25-31, 2015*, pp. 461–467.
- Bachrach, Y., Kohli, P., Kolmogorov, V., & Zadimoghaddam, M. (2013). Optimal coalition structure generation in cooperative graph games. In *Proceedings of the Twenty-Seventh AAAI Conference on Artificial Intelligence, July 14-18, 2013, Bellevue, Washington, USA*.
- Bachrach, Y., Meir, R., Jung, K., & Kohli, P. (2010). Coalitional structure generation in skill games. In *Proceedings of the Twenty-Fourth AAAI Conference on Artificial Intelligence, AAAI 2010, Atlanta, Georgia, USA, July 11-15, 2010*.
- Ballester, C. (2004). Np-completeness in hedonic games. *Games and Economic Behavior*, 49(1), 1 – 30.
- Balliu, A., Flammini, M., Melideo, G., & Olivetti, D. (2017a). Nash stability in social distance games. In *Proceedings of the Thirty-First AAAI Conference on Artificial Intelligence, February 4-9, 2017, San Francisco, California, USA.*, pp. 342–348.
- Balliu, A., Flammini, M., & Olivetti, D. (2017b). On pareto optimality in social distance games. In *Proceedings of the Thirty-First AAAI Conference on Artificial Intelligence, February 4-9, 2017, San Francisco, California, USA.*, pp. 349–355.
- Banerjee, S., Konishi, H., & Sönmez, T. (2001). Core in a simple coalition formation game. *Social Choice and Welfare*, 18(1), 135–153.
- Bansal, N., Blum, A., & Chawla, S. (2004). Correlation clustering. *Machine Learning*, 56(1), 89–113.
- Bilò, V., Fanelli, A., Flammini, M., Monaco, G., & Moscardelli, L. (2014). Nash stability in fractional hedonic games. In *Web and Internet Economics - 10th International Conference, WINE 2014, Beijing, China, December 14-17, 2014. Proceedings*, pp. 486–491.
- Bilò, V., Fanelli, A., Flammini, M., Monaco, G., & Moscardelli, L. (2015). On the price of stability of fractional hedonic games. In *Proceedings of the 2015 International Conference on Autonomous Agents and Multiagent Systems, AAMAS 2015, Istanbul, Turkey, May 4-8, 2015*, pp. 1239–1247.

- Bloch, F., & Diamantoudi, E. (2011). Noncooperative formation of coalitions in hedonic games. *International Journal of Game Theory*, 40(2), 263–280.
- Bogomolnaia, A., & Jackson, M. O. (2002). The stability of hedonic coalition structures. *Games and Economic Behavior*, 38(2), 201 – 230.
- Brandl, F., Brandt, F., & Strobel, M. (2015). Fractional hedonic games: Individual and group stability. In *Proceedings of the 2015 International Conference on Autonomous Agents and Multiagent Systems, AAMAS 2015, Istanbul, Turkey, May 4-8, 2015*, pp. 1219–1227.
- Deng, X., & Papadimitriou, C. H. (1994). On the complexity of cooperative solution concepts. *Math. Oper. Res.*, 19(2), 257–266.
- Dreze, J., & Greenberg, J. (1980). Hedonic coalitions: Optimality and stability. *Econometrica*, 48(4), 987–1003.
- Elkind, E., Fanelli, A., & Flammini, M. (2016). Price of pareto optimality in hedonic games. In *Proceedings of the Thirtieth AAAI Conference on Artificial Intelligence, February 12-17, 2016, Phoenix, Arizona, USA.*, pp. 475–481.
- Elkind, E., & Wooldridge, M. (2009). Hedonic coalition nets. In *8th International Joint Conference on Autonomous Agents and Multiagent Systems (AAMAS 2009), Budapest, Hungary, May 10-15, 2009, Volume 1*, pp. 417–424.
- Feldman, M., Lewin-Eytan, L., & Naor, J. (2012). Hedonic clustering games. In *24th ACM Symposium on Parallelism in Algorithms and Architectures, SPAA '12, Pittsburgh, PA, USA, June 25-27, 2012*, pp. 267–276.
- Flammini, M., Monaco, G., Moscardelli, L., Shalom, M., & Zaks, S. (2018). Online coalition structure generation in graph games. In *Proceedings of the 2018 International Conference on Autonomous Agents and Multiagent Systems, AAMAS 2018, Stockholm, Sweden, July 10-15, 2018*. To appear.
- Flammini, M., Monaco, G., & Zhang, Q. (2017). Strategyproof mechanisms for additively separable hedonic games and fractional hedonic games. In *Proceedings of The 15th Workshop on Approximation and Online Algorithms WAOA 2017, Vienna, Austria, September 7-8, 2017*, pp. 301–316.
- Gairing, M., & Savani, R. (2010). Computing stable outcomes in hedonic games. In *Algorithmic Game Theory - Third International Symposium, SAGT 2010, Athens, Greece, October 18-20, 2010. Proceedings*, pp. 174–185.
- Garey, M. R., & Johnson, D. S. (1990). *Computers and Intractability; A Guide to the Theory of NP-Completeness*. W. H. Freeman & Co., New York, NY, USA.
- Kaklamanis, C., Kanellopoulos, P., & Papaioannou, K. (2016). The price of stability of simple symmetric fractional hedonic games. In *Algorithmic Game Theory - 9th International Symposium, SAGT 2016, Liverpool, UK, September 19-21, 2016. Proceedings*, pp. 220–232.
- Koutsoupias, E., & Papadimitriou, C. H. (2009). Worst-case equilibria. *Computer Science Review*, 3(2), 65–69.



- Monaco, G., Moscardelli, L., & Velaj, Y. (2018). Stable outcomes in modified fractional hedonic games. In *Proceedings of the 2018 International Conference on Autonomous Agents and Multiagent Systems, AAMAS 2018, Stockholm, Sweden, July 10-15, 2018*. To appear.
- Ohta, N., Conitzer, V., Ichimura, R., Sakurai, Y., Iwasaki, A., & Yokoo, M. (2009). Coalition structure generation utilizing compact characteristic function representations. In *Principles and Practice of Constraint Programming - CP 2009, 15th International Conference, CP 2009, Lisbon, Portugal, September 20-24, 2009, Proceedings*, pp. 623–638.
- Olsen, M. (2009). Nash stability in additively separable hedonic games and community structures. *Theory Comput. Syst.*, 45(4), 917–925.
- Olsen, M. (2012). On defining and computing communities. In *Eighteenth Computing: The Australasian Theory Symposium, CATS 2012, Melbourne, Australia, January 2012*, pp. 97–102.
- Peters, D. (2016). Graphical hedonic games of bounded treewidth. In *Proceedings of the Thirtieth AAAI Conference on Artificial Intelligence, February 12-17, 2016, Phoenix, Arizona, USA.*, pp. 586–593.
- Peters, D., & Elkind, E. (2015). Simple causes of complexity in hedonic games. In *Proceedings of the Twenty-Fourth International Joint Conference on Artificial Intelligence, IJCAI 2015, Buenos Aires, Argentina, July 25-31, 2015*, pp. 617–623.
- Rahwan, T., & Jennings, N. R. (2008). An improved dynamic programming algorithm for coalition structure generation. In *7th International Joint Conference on Autonomous Agents and Multiagent Systems (AAMAS 2008), Estoril, Portugal, May 12-16, 2008, Volume 3*, pp. 1417–1420.
- Rahwan, T., Michalak, T. P., Wooldridge, M., & Jennings, N. R. (2012). Anytime coalition structure generation in multi-agent systems with positive or negative externalities. *Artif. Intell.*, 186, 95–122.
- Rahwan, T., Michalak, T. P., Wooldridge, M., & Jennings, N. R. (2015). Coalition structure generation: A survey. *Artif. Intell.*, 229, 139–174.
- Rahwan, T., Ramchurn, S. D., Jennings, N. R., & Giovannucci, A. (2009). An anytime algorithm for optimal coalition structure generation. *J. Artif. Intell. Res.*, 34, 521–567.
- Sandholm, T., Larson, K., Andersson, M., Shehory, O., & Tohmé, F. (1999). Coalition structure generation with worst case guarantees. *Artif. Intell.*, 111(1-2), 209–238.
- Shehory, O., & Kraus, S. (1998). Methods for task allocation via agent coalition formation. *Artif. Intell.*, 101(1-2), 165–200.
- Turán, P. (1941). On an extremal problem in graph theory. *Matematikai és Fizikai Lapok*, 48, 436–452.
- Ueda, S., Iwasaki, A., Yokoo, M., Silaghi, M., Hirayama, K., & Matsui, T. (2010). Coalition structure generation based on distributed constraint optimization. In *Proceedings of*

*the Twenty-Fourth AAAI Conference on Artificial Intelligence, AAAI 2010, Atlanta, Georgia, USA, July 11-15, 2010.*

Voice, T., Polukarov, M., & Jennings, N. R. (2012). Coalition structure generation over graphs. *J. Artif. Intell. Res.*, *45*, 165–196.

Zick, Y., Markakis, E., & Elkind, E. (2014). Arbitration and stability in cooperative games with overlapping coalitions. *J. Artif. Intell. Res.*, *50*, 847–884.