



HAL
open science

Wooden Musical Instruments - Different Forms of Knowledge

Marco Antonio Pérez, Emanuele Marconi

► **To cite this version:**

Marco Antonio Pérez, Emanuele Marconi (Dir.). Wooden Musical Instruments - Different Forms of Knowledge: Book of End of WoodMusICK COST Action FP1302. Marco A. Pérez; Emanuele Marconi. 2018, 979-10-94642-35-1. hal-02086598

HAL Id: hal-02086598

<https://hal.science/hal-02086598>

Submitted on 1 Apr 2019

HAL is a multi-disciplinary open access archive for the deposit and dissemination of scientific research documents, whether they are published or not. The documents may come from teaching and research institutions in France or abroad, or from public or private research centers.

L'archive ouverte pluridisciplinaire **HAL**, est destinée au dépôt et à la diffusion de documents scientifiques de niveau recherche, publiés ou non, émanant des établissements d'enseignement et de recherche français ou étrangers, des laboratoires publics ou privés.

Musical instruments are fundamental tools of human expression that reveal and reflect historical, technological, social and cultural aspects of times and people. These three-dimensional, polymeric objects—at times considered artworks, other times technical objects—are the most powerful way to communicate emotions and to connect people and communities with the surrounding world. The participants in WoodMusICK (WOODen MUSical Instrument Conservation and Knowledge) COST Action FP1302 have aimed to combine forces and to foster research on wooden musical instruments in order to preserve, develop and disseminate knowledge on musical instruments in Europe through inter- and transdisciplinary research. This four-year program, supported by COST (European Cooperation in Science and Technology), has involved a multidisciplinary and multi-national research group composed of curators, conservators/restorers, wood, material and mechanical scientists, chemists, acousticians, organologists and instrument makers. The goal of the COST Action was to improve the knowledge and preservation of wooden musical instruments heritage by increasing the interaction and synergy between different disciplines.



Wooden Musical Instruments — Different Forms of Knowledge



**Wooden Musical Instruments
Different Forms of Knowledge**
Book of End of WoodMusICK
COST Action FP1302

Edited by MARCO A. PÉREZ and EMANUELE MARCONI

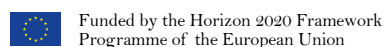

Illustrations: Front cover © Succession Picasso;
ISBN 979-10-94642-35-1 / PRINTED IN FRANCE / OCTOBER 2018



Wooden Musical Instruments Different Forms of Knowledge

Book of End of WoodMusICK
COST Action FP1302

Edited by MARCO A. PÉREZ and EMANUELE MARCONI

Table of Contents

- 7 FOREWORD
- 9 *Instrument (Re-)construction as a Catalyst for Organological Research*
GEERTEN VERBERKMOES
- 35 *Material or Immaterial? A Questionnaire to Help Decisions About the Preservation of Musical Instruments*
VERA DE BRUYN-OUBOTER
- 53 *Adopting a Policy of Faithful Copies of Historically Important Musical Instruments as an Alternative to Restoration*
JOHN RAY, ANTONIO MANJÓN, AARON GARCÍA
- 67 *Methods of Dendrochronology for Musical Instruments*
MAURO BERNABEI, KATARINA ČUFAR
- 81 *Tropical and Traditional Wood Species in Musical Instruments and Case Studies of Their Substitution with Modified Wood*
MARIO ZAUER, ALEXANDER PFRIEM
- 99 *Assessing the Impact of Conservation Materials on the Acoustic Properties of Woodwind Musical Instruments*
EFSTATHIOS DOGANIS, SANDIE LECONTE,
ANASTASIA POURNOU
- 119 *Revisiting the Notion of “Resonance Wood” Choice: A Decompartmentalised Approach, from Violin-Makers’ Opinion and Perception to Characterization of Material Properties’ Variability*
C. CARLIER, A. ALKADRI, J. GRIL, I. BRÉMAUD
- 143 *Non-Destructive Investigation of Historical Instruments Based on 3D-Reflected-Light Microscopy and High-Resolution μ -X-ray CT*
VOLKER HAAG, SEBASTIAN KIRSCH, GERALD KOCH,
VALENTINA ZEMKE, HANS-GEORG RICHTER
- 157 *X-Ray CT and Neutron Imaging for Musical Instruments A Comparative Study*
SEBASTIAN KIRSCH, DAVID MANNES



Soutien apporté par la Fondation des Sciences du Patrimoine
LabEx Patrima (Investissements d’avenir,
réf. ANR-10-LABX-0094-01).

ISBN 979-10-94642-35-1

© CITÉ DE LA MUSIQUE - PHILHARMONIE DE PARIS, 2018

www.philharmoniedeparis.fr

- 171 *Three-Dimensional Computed Tomography Scanning of Musical Instruments*
FRANK P. BÄR, THEOBALD FUCHS, SEBASTIAN KIRSCH,
REBECCA WAGNER, GABRIELE SCHOLZ, CHRISTIAN
KRETZER, RICHARD SCHIELEIN, GUIDO BRENNHÄUSSER,
MICHAEL BÖHNEL, NILS REIMS, MARKUS EBERHORN,
TOBIAS KOPPERS, MARKUS RAQUET,
MEIKE WOLTERS-ROSBACH, KATHRIN FISCHIEDL,
SARAH WAGNER, MARKUS ZEPF
- 189 *Application of X-Ray Computed Tomography in Diagnostics
and Reverse Engineering of Bowed Stringed Musical Instruments*
F. PIASENTINI, M. MOSCATTI, S. CARMIGNATO
- 207 *Geometrical Analysis on the Design of Stringed Instruments – A Useful
Method for Luthiers and Musicologists?*
SIMONE REGINA ZOPF, FLORIAN HERTZSCH,
MANUEL HROVATH, JAKOB NACHBARGAUER,
ANDREAS SEYER-KLICZNIK
- 227 *Sibire's Aesthetic Sensibility:
Stradivarius, the Classical Ideal and a New Noble Purpose*
CHRISTINA LINSENMEYER
- 249 *The Acoustics and Historic Development of String Instruments*
GEORGE STOPPANI, COLIN GOUGH
- 269 *Violins, Pochettes, or Mute violins? Shining a Light on the "Violins
Without Sides"*
J. SANTA MARIA BOUQUET, S. KIRSCH,
M. ALBANO, A. RIGAMONTI
- 291 *Virtual Experiments on Stringed Wooden Instruments: Influence
of Mechanical and Climate Loading*
DANIEL KONOPKA, MICHAEL KALISKE
- 311 *Restoration of the Mother-and-Child Virginal by Ioannes Ruckers
(Antwerp, 1610): The Choice of a New Presentation With a Focus on
the Difficult Problem of Soundboard Cleaning*
AGNÈS ESQUIROL, LIVINE HUART, CÉCILE DE BOULARD
- 325 *FA-RE-MI (Faire parler les instruments de musique du patrimoine):
Making Historical Musical Instruments Speak*
STÉPHANE VAIEDELICH, H. BOUTIN, ARTHUR PATÉ,
A. GIVOIS, B. FABRE, S. LE CONTE, J.-L. LECARROU
- 343 *Early Development Process of the Steinway & Sons Grand Piano
Duplex Scale*
NIKO PLATH, KATHARINA PRELLER
- 367 *A Synergy of Form, Function and Fashion in the Manufacture
of the Erard Harp*
PANAGIOTIS POULOPOULOS, JULIN LEE
- 399 *The Music of the Mulberry: Wood Science, Know-How and Symbolism
in Instrument-Making in Khorāssān (Iran) and Central Asia*
FARROKH VAHABZADEH

FOREWORD

The universally shared emotion caused by the loss of emblematic objects or sites of cultural patrimony, be it the unfortunate result of unstoppable degradation, or perhaps the result of deliberate political will, shows how much the knowledge, safeguarding and understanding of cultural heritage represents a virtuous element of social cohesion in the development of civilizations in democratic societies.

There is no society without music: music is a language that cannot be expressed without instruments, and it holds a special place in every cultural tradition. Not only musical and functional and/or technical objects, instruments are also often objects of art. As such, their identities cannot be deciphered without an approach combining several scientific disciplines. Among the materials from which instruments are made, wood—an exceptional technical material imbued with myths and symbols—reigns supreme in their manufacture.

The COST Association, part of the Scientific European Commission, sought to support a musical instrument-based project to strengthen the bridge between the humanities and the natural sciences, within the framework of European research and conservation of cultural heritage. The COST Action WoodMusICK (WOODen MUSical Instrument Conservation and Knowledge) was created in 2013. The network brought together different fields of research (wood sciences, history, acoustics, conservation, chemistry, ethnomusicology, etc.) and professionals from diverse backgrounds (academic researchers, instrument makers and museum professionals).

Grouped around the study of wooden musical instruments, these scientific communities were able to compare their experiences, discuss their views and invent a new form of dialogue. Within a short time, more than twenty-three countries had joined the project, evidence of a pressing need in this area which, we hope, the COST FP1302 WoodMusICK project has fulfilled.

The richness of the exchanges, focused around the annual meetings boosted by the project, the resultant number of ‘short missions’ initiated by young researchers, the large body of scientific works published in four years, and the continued involvement of musical instrument makers all demonstrate that COST FP1302 WoodMusICK created a new community of musical instrument researchers. Several innovative lines of research arose from the activities of this new community, combining probes into emerging digital tools (neutrons, X-rays, nanotechnology, in situ microscopy, predictive mechanics) with

the issues of historical reconstruction and preservation of the musical instrument heritage within public and private collections.

This book is a selection of contributions obtained after four years of meetings and collaborations between musical instrument researchers from twenty-three European countries, and aims to summarize and present the different approaches and lines of research that constituted the essence of WoodMusICK. It does not represent the end of the project, but rather is an opportunity to promote education, and opens a second phase of periodic meetings aimed at continually improving our knowledge of musical instruments.

I am indebted to Emanuele Marconi and Marco Antonio Perez who have accepted to be in charge of this book and who have made possible the publication on time. We are grateful to the assistant editors: Gabriele Rossi Rognoni and Pascale Vandervellen who belong to the Steering Committee of this Action (see below), Daniel Konopka, Anastasia Pournou, Stéphane Vaiedelich and Simone Zopf. After this four years COST project, my deepest thanks to Pascale Vandervellen, the vice-chair of this Action who has accepted to build the bridge between humanities and natural sciences. More largely, many thanks to the Steering Committee of this Action: Iris Bremaud, Marco Fioravanti, Claudia Fritz, Michael Kaliske, David Mannes, Marco Antonio Perez (again...), Carmen Popescu, Gabriele Rossi Rognoni, and Christina Young. Lastly, I am grateful to Isabelle Hoefkens who has managed very well the financial issue of this program.

SANDIE LE CONTE

Chairwoman of COST Action FP1302

Musée de la musique,

Cité de la musique – Philharmonie de Paris

Instrument (Re-)construction as a Catalyst for Organological Research

GEERTEN VERBERKMOES

Department of Art, Music and Theatre Sciences, Ghent University, Belgium

Department of Musical Instrument Making, University College Ghent,

School of Arts, Belgium

Abstract

This essay discusses the pivotal role the instrument (re-)construction process can play as an initiator for new knowledge, methods and cross-connections within the field of organological research. In order to illustrate this approach, a case study is presented in the form of a Ph.D. research project on the life, instruments and construction methods of the violin-maker Benoit Joseph Boussu (1703–1773). This project comprises four distinct phases of research: a biographical study, study of surviving instruments, the creation of instrument replicas, and the application of these replicas in musical performances. For each phase, the employed approach, methodology and results are exemplified.

1. Introduction

The study of musical instruments can be approached from many different perspectives and backgrounds. Musicologists and musicians may investigate and classify instruments by their musical functionality and applications. Acousticians will be interested in the sonic properties and the way these musical tools function from a physical point of view, whereas historians and cultural sociologists may research the role of instruments in past and present communities.

A somewhat peculiar category of individuals to study musical instruments is formed by instrument-makers, since they are usually more involved in the practical side of things, the actual manufacturing, and less in scholarly activities surrounding instruments. Still, they have a very close relationship to the object, even literally in the sense that they have shaped and held in their hands each of its individual components. In order to comprehend the architecture and manufacturing process of (historical) instruments, makers are inclined to look beyond outer characteristics and musical application, trying to understand what is beneath that surface of wood, metal or ivory. Like a curious youngster dismantling an obsolete electronic device to discover the interior, makers want to look inside, or even better, through the objects of their interest, and nowadays the technical means to do so are available more than ever before.

It is from this deep incentive to understand the structure and creation process of instruments that makers can contribute their unique expertise and methodologies to the field of organology. Moreover, in making reconstructions of historical instruments, their practical activities could become the nucleus for a multi-faceted organological study project, where “workbench research” generates questions, answers and understanding, while also allowing for the practical testing of construction hypotheses. The following essay will thus discuss the pivotal role the instrument (re-) construction process can play as a catalyst for new knowledge, methods and collaborations within the field of organological research.

In order to illustrate this approach, the second part of the text presents a case study, in the form of the author’s ongoing Ph.D. research project (2015 – 2020) at Ghent University and the School of Arts Ghent. This study investigates the life, instruments and working methods of the eighteenth-century violin-maker Benoit Joseph Boussu (1703–1773). Furthermore, the obtained insights are ultimately employed, and at the same time critically assessed, by building violin and cello replicas after original Boussu examples (the latter are now in a museum collection, where they are no longer allowed to be tuned or played). In the final stage of the study, these replicas are used in a musical project to perform repertoire from the original instruments’ time and place, in order to assess the sonic and playing characteristics of the newly made instruments, and thus the originals on which they are based.

This essay is written from the perspective of the research on and replication or reconstruction of violin-family instruments, but the ideas and concepts expressed may also be valid for the study of other types of instruments.

2. The Instrument-Maker as Organological Researcher

According to a common generalisation, there are “thinkers”, and there are “doers”. Supposedly, makers of musical instruments, like other craftsmen, are exponents of the latter archetype. In order to repeatedly produce, by manual labour, physical artefacts such as musical instruments, makers must not be living too much inside their heads, but instead remain focused on completing their products without the inhibitions of too much rationalisation and reflection.

On the other hand, scientific research on musical instruments is typically performed by scholars with a thorough academic background. Even today, the majority of organological publications comes from authors with a degree in musicology, art history, art conservation or a comparable field, people that may easily be counted among the “thinkers” category, while makers are still in minority when it comes to contributions to organological publications and conferences. Perhaps hints of the old dogma of the “trade secrets” from the guild times still quietly persist within the present-day craft field. This makes one wonder if there is a place within the area of scholarly musical instrument research for practice-oriented craftsmen.

The doers are the major thinkers.

Steve Jobs (1990)

Yet, for several reasons, it can be argued that instrument manufacturers bring unique qualities and skills to the research table. First of all, the maker’s attention to detail, sharpened by the practice of instrument construction, can allow him or her to notice things that other people may overlook. Likewise, their hands-on know-how of various construction processes allows them to interpret the smallest particularities, such as tool marks, scratch lines or signs of modifications, as clues for the making techniques employed by the original maker, or as signs of configurative changes or repairs.

Furthermore, the result-oriented approach of makers investigating an original instrument—where the examination is often aimed at documentation in service of the construction of a convincing copy—encourages them to examine not only the superficial appearance of an instrument, but also the interior. Nowadays, state-of-the-art techniques such as computed tomography (CT) scanning and digital endoscopy, enable such revealing examinations, and may even allow “virtual”

measurements to be taken and construction drawings to be produced. Obviously, to make advanced investigations like this possible, a maker would have to seek collaboration with scanning facilities and radiological specialists. Similarly, a maker may want to cooperate with chemists, acousticians, wood technologists and dendrochronologists in order to collect a variety of additional information required for an instrument reconstruction or replication. In other words, the practice-oriented maker would have to enter the field of scientific research. This may be an intimidating step, but when taken, the reconstruction process could become the nucleus around which a multi-disciplinary research project would develop. This approach may even be extended to the historical, social, cultural and musicological areas, for example by studying the biography of a historical maker and the social and economic conditions under which he lived and worked, to find out if these circumstances had any influence on his production rate, creative decisions, material selection, clientele and so on, while instrument attributions (based on label texts) could be validated by comparison to biographical data. Or even more, to study the musical applications of a replica under construction. Again, to collect and interpret such contextual information, collaborations must be developed, this time with scholars in the field of humanities.

Another argument for the integration of makers into the organological community can be found in the relationship between instrument-makers and the area of musical performance. Authentic performance practice, or historically informed performance, has developed steadily since it first emerged in the twentieth century. The most important question, and one that we can never fully answer due to the “incompleteness of the evidence” [1], remains “how did the music really sound in the days when it was composed”? The use of appropriate instruments, originals or replications, closely connected to the chronological and geographical provenance of the played repertoire, is one of the fundamental prerequisites in attempting a faithful performance. In reality, even today after more than five decades of endeavour for authentic performance, it does not always seem possible or practically feasible to employ instruments exactly tailored for a specific repertoire due to unavailability of a broad spectrum of instruments, leading to compromises regarding sound, setup, pitch and temperament. For example, the performance of a broad range of Baroque repertoire from between 1600 and 1750 on truly faithful violins would require at least three or four instruments in different configuration and setup (with corresponding bows!), an effort that not all Baroque violinists will make. According to Wilson [2], “Such practical considerations have had a bearing on what was and what was not done by way of ‘historically informed performance practice’”. Also, personal preferences on the part of musicians may further contribute to the use of instruments that are not fully optimized for a certain repertoire.

In addition, in more recent years, the focus of the historically informed performance practice has gradually shifted towards repertoire beyond the Baroque era. Authentic performance of music from the Classical and Romantic periods will ask for other instruments, and this opens a whole new field of instrument research and (re-)creation. As is evident from the above, the specific expertise and interest of makers regarding technical aspects—such as instrument configurations (for both original instruments, re-constructed originals or modern replicas), dimensions and string choice—calls for their participation in organological research. In the case of modern replicas and reconstructions, makers are the manufacturers of the sound-tools used by performers, and are thus providing the essential physical equipment required to convert the ideas of musicians, composers, music theorists and musicologists into a sounding musical reality. However, the tools for true “informed performance” will only be as satisfactory and reliable as possible if they were maintained, modified or newly produced according to the concept of “informed making”. And this is exactly where the expertise of the instrument-maker is indispensable.

What’s in a name...?

When an instrument—or any other object—is produced after a (historical) example, there are several ways to name the resulting product. The term “copy” is the more generic designation, indicating an object was produced in the image of an original, the degree of similarity to the original being more or less pronounced. In instrument-making in particular, the indication “inspired copy” implies that the copyist’s intention was more to capture the spirit or concept of the original, rather than to duplicate the original as precisely as possible. Some makers even employ acoustic techniques to pursue a “tonal copy”, reproducing the instrument’s sound more than its appearance, or a “bench copy”, normally an imitation of a famous instrument, up to the point where even the smallest scratches and dents are copied. When a maker tries to reproduce an original instrument that has been modified throughout time, with the intention to reflect in the newly made instrument a possible initial or earlier state, then the denomination “reconstruction” comes in use. An example of this is a reproduction of a modernized seventeenth-century violin, the reproduction having a “Baroque” configuration. In order to make the reconstruction as faithful as possible, research is needed to find information for the reconstructed parts. Sources such as remnant untouched instruments or iconography become indispensable. The denominations “replica” and “facsimile” indicate that a maximum degree of exactitude was envisioned, possibly also involving historical, and sometimes forgotten, production processes to achieve

the highest level of similarity between copy and original. In this respect, the study of the making process can become a goal by itself. The words “imitation”, “duplication” and “clone” are less often used for musical instrument copies, while the terms “fake”, “forgery” or “counterfeit” are obviously employed to indicate that the maker of the copy had less than honourable intentions.

As stated earlier, the knowledgeable examination of a musical instrument will not only expose its current state and condition, but can also reveal clues regarding previous configurations or even the construction process. With the right know-how, this type of information can be used to derive the possible techniques employed by the maker of the original instrument, or even to propose a hypothesis on a construction sequence. Once such a hypothesis has been formulated, an effective way to test it is to actually execute the proposed steps, in the production of test pieces or even an entire instrument. Only someone with an instrument-making background would be able to execute such performative research, and interpret the outcome in terms of practical feasibility, expected product specifications and time-effectiveness.

Thus, from the above arguments, it may be concluded that there is certainly a role for makers within the organological community. In order to fulfil such a position, however, affinity and experience regarding systematic research appear to be essential. A researching instrument-maker would thus have to develop in dual directions, becoming a scholar in addition to being a craftsman, a “thinker” as well as a “doer”, and to develop a *modus operandi* in which theory feeds practice and *vice versa*.

To achieve this duality, nonetheless, there may be several pitfalls along the way. A craftsman willing to perform organological research according to established academic principles will have to come out of his or her practice-drenched comfort zone and gain the appropriate academic attitude and competences. Theoretical knowledge, ranging from musicology to physics, and from organology to history, has to be obtained, along with competency in areas such as data acquisition and analysis, project management and writing and presentation skills. Scholarly values, such as objectivity and ethical practice must become second nature, while furthermore, the craftsman may have to put aside any ambiguity towards the theoreticism of the scholar.

What is more, in some branches of the musical instrument business, under makers and musicians alike, there appears to be a fascination with big names and a certain mythology. The violin world, where these pre-occupations appear to be strongest of all, has its “Cremona cult”, leading to the belief amongst many players and listeners that a soloist can only deliver a worthwhile performance when playing a famous antique Italian instrument, and sustaining a dominant monoculture of

Stradivari-copying amongst makers. From this viewpoint, there may be strong scepticism towards organological scholarship, since its activities and opinions could be regarded as an attempt to degrade the constructed myths. The controversies surrounding the attribution of the “Messiah” violin may be illustrative in this light. Whilst these views are most common amongst violin players and makers, a similar fixation with name and fame occurs within the areas of some other instrument families too.

Another competence the researching instrument-maker will have to develop in order to transform into a full-fledged organologist, is the habit of communicating his or her research findings through the proper scientific channels. Articles written specifically by makers are hard to find in organological publications such as *The Galpin Society Journal* and the *Journal of the American Musical Instrument Society*, while makers are also under-represented at organological conferences. Indeed, the violin community has its own monthly periodical, aimed at both players and makers, which regularly features interesting contributions written by makers. Yet, this magazine does not practice the peer review process, nor does it include reference footnotes, and consequently its articles do not hold true scholarly validity. And is the information contained in leather-bound books issued by the violin business truly objective, or are these publications primarily intended as prestigious promotional material?

Last but not least, due to their backgrounds, makers may not be always properly trained to judge the fragility of historical cultural heritage objects and handle them accordingly. In addition, their pragmatic attitude may push them to take a certain measurement at all cost, losing sight of the well-being of the instrument under study. It would therefore be necessary to train researching instrument-makers in how to safely and responsibly perform their instrument investigations. An unfortunate example to illustrate this issue is provided by indentation damage on the top plates of Boussu violin MIM inv. no. 2781 and Boussu cello MIM inv. no. 1372, discovered during the course of the current research project, caused only recently by—thus far unidentified—examiners who had apparently used a profile gauge in an attempt to register the top plate archings of both instruments. These incidents demonstrate the importance of awareness of the vulnerability of old instruments and the abandoning of potentially harmful measuring methods in favour of contactless ones, such as CT scanning, to prevent similar damage to other instruments in the future.

Thus, the requirements imposed on a maker/researcher in accordance with the above viewpoints are not to be neglected. Still, if makers are prepared to make the transition from their workshop to the academic arena, they can become valuable contributors and initiators in the territory of musical instrument research, and their specific knowledge and practice-driven approach can bring new insights and élan to the field.

For the sake of illustration, the next section will present a case study—the author’s research project—where an attempt was made to put some of the above ideas into practice.

3. A Case Study: The Replication of Instruments by the Eighteenth-Century Violin-Maker Benoit Joseph Boussu

The name of the violin-maker Benoit Joseph Boussu first came to my attention in the fall of 2008, when I wanted to make a copy of a “Baroque” violin still in an unmodified state. Preferably, the original instrument had to be available at a nearby geographic location, to make access to the instrument easier. To find a suitable instrument, Karel Moens—at that time curator at the Vleeshuis museum in Antwerp—was consulted, since he is regarded as one of the leading experts in the field of historical bowed stringed instruments. Moens did not have to think long about my question; according to him, the Boussu violin inv. no. 2781 from the Musical Instruments Museum (MIM) collection in Brussels was one of the few reliable, unmodified eighteenth-century instruments in Belgium, if not in the whole of Europe. Following the advice of Moens, I soon started a first study of the recommended violin, under the guidance of then MIM staff member Guy Buyse. This research yielded the required information to start the reproduction process, and during the following year, the first two copies were manufactured.

Meanwhile, my interest in the life and background of Boussu was sparked, especially since very little information on this maker was available. The existing encyclopaedias and reference books on violin-makers contained only a few lines regarding this maker—mostly repeating each other—citing that he worked around Brussels between 1750 and 1780 and built after Amati. The dates and places of his birth and death were unknown, as were his personal life and background. For me, that tiny bit of biographical data triggered my curiosity, instead of satisfying it, laying the foundation for an extensive quest into the life, instruments and working methods of the maker, which eventually resulted in the commencement of a Ph.D. project in early 2015. The following four paragraphs will discuss the four distinct research phases of this project.

3.1 Project Phase 1 – Biographical Research

In order to find out more about Boussu’s life, a biographical study was undertaken, consisting mostly of research in various archives, especially the Archives départementales du Nord (Lille, France), the City and State Archives in Brussels (Belgium) and the City Archives in Amsterdam (The Netherlands). This initial archive research, carried out between 2010 and 2013, resulted in the elucidation and publication of many biographical facts [3]. Further archive studies, performed between 2014 and 2016

yielded additional insights [4]. As a result, it is now known that Boussu was born in Fourmies, in northern France, in 1703 to a family of notaries. He also worked as a notary and attorney in the town of Avesnes, in his birth area, between 1729 and 1748. A cello, built in 1749 in Liège, is the earliest known instrument by his hand. Soon after, between c.1751 and at least 1762, he worked as luthier in and near Brussels, where he was very productive given the many surviving instruments from that period. Boussu married twice and had many children, the majority of whom died in infancy. For the final part of his life, c.1765–1772, he lived and worked in Holland, possibly first in Leiden but later certainly in Amsterdam, although just one instrument, a cittern, is extant from that period. He died in his native region in 1773. Current study of over hundred legal documents concerning Boussu's transactions, such as acts from notaries and local courts of justice, at the moment being transcribed and interpreted for possible future publication, demonstrate that he maintained financial interests and rural heritage property in his birth area throughout his entire life. Law historians Prof. em. Veronique Demars-Sion and Prof. Georges Martyn have contributed their valuable help to the transcription and interpretation of these acts, from which it further becomes clear that Boussu confronted close family members and local authorities several times in the courtroom. His background as a notary and attorney may have contributed to his apparent success in these cases; by knowing some legal “loopholes” he managed to secure his rights and possessions.

Apparently, Boussu did not have an initial background as an instrument-making craftsman. Instead, he may be considered a literate, maybe even somewhat respectable citizen, due to his abilities to read and write. This makes one wonder *why* he made a career-switch in his mid-40s and *how* he learned to build bowed stringed instruments; the exact answers to these riddles remain missing so far. Anyhow, it appears that Boussu managed to attract a local clientele in Brussels, ranging from amateurs, to professional musicians, to the ensemble of the St. Michael and St. Gudula church. His many relocations demonstrate that he was of a venturesome disposition, apparently constantly looking for better economic perspectives and living conditions and taking initiatives to realize his personal ambitions and visions, even if this meant abandoning his respectable status as a notary for the more humble position of craftsman.

3.2 Project Phase 2 – Instrument Research

A second main theme entwined in the Boussu project, besides the biographical research, is that of identifying this maker’s surviving instruments, in order to study their aesthetic and constructional features and to hypothesize about a possible sequence for the way they were made. The MIM collection alone contains nine Boussu instruments (six violins, two cellos and one bass), with one violin and one cello in virtually

untouched state—although these instruments are not allowed to be tuned or played—while another 40 or so surviving instruments have been identified in other institutional collections and private ownership. Among this latter category are many violins, half a dozen cellos, a few violas, one other bass, a dance master violin and a cittern. Most of these have been studied and documented using traditional techniques, including recording dimensions and plate thicknesses, capturing the instrument on photo and endoscopic examination of the inside of the sound box. Currently, a database of all these instruments, including the basic measurements and photos, is being set up. The study of such a vast amount of instruments by the same maker provides profound insights into his production rate and constructional and artistic characteristics and evolution.

From observations of this substantial collection of surviving instruments, it appears as if Boussu developed his own hybrid working system. He most likely based his approach on both familiarity with local traditions (the “through neck”, where neck and upper block are made from a single piece of wood) as well as his observation of the constructional features of foreign instruments that came under his attention (ribs glued *onto* the back plate, *not* inserted *into* it, and the use of linings and corner blocks). Makers like Boussu, who did not have an apprentice/master type of formation in the craft, must have developed their own working system, since the publication of violin making manuals resulting in standardisation of making methods would still be far away.

For several violins, cellos and violas, as well as for the cittern, CT scanning was performed in cooperation with leading experts, in order to gain additional insight into their construction. In one of these studies, two Boussu violins along with several other MIM instruments by Boussu's Brussels predecessors and contemporaries were included to get a broader view of the development of violin-making techniques practised in that city. The results of this CT study—made possible through the cooperation of MIM curator Dr. Anne-Emmanuelle Ceulemans and further MIM staff, Prof. em. Danielle Balériaux (Erasmus hospital, Brussels) and Dr. Berend Stoel (Leiden University Medical Center)—were recently published [5]. For the purpose of illustration, **Fig.1(a) to (e)** give several examples of images acquired with CT scanning and digital endoscopy. A similar study of a 1771 Boussu cittern was published as well [6]. The resulting CT images offer detailed information on the internal architecture of the examined instruments, as well as providing the basis for accurate technical construction plans, which are indispensable for making reconstructions or replicas. Of particular note is the neck of violin MIM inv. no. 2781. This part maintains its original “post-Baroque”, transitional configuration, given its dimensions (a length of 130 mm, a neck angle of 86 degrees, a protrusion over the top plate of 1 mm and a fingerboard projection at the bridge of 22 mm). The neck also holds its original short veneered fingerboard.

Fig.1

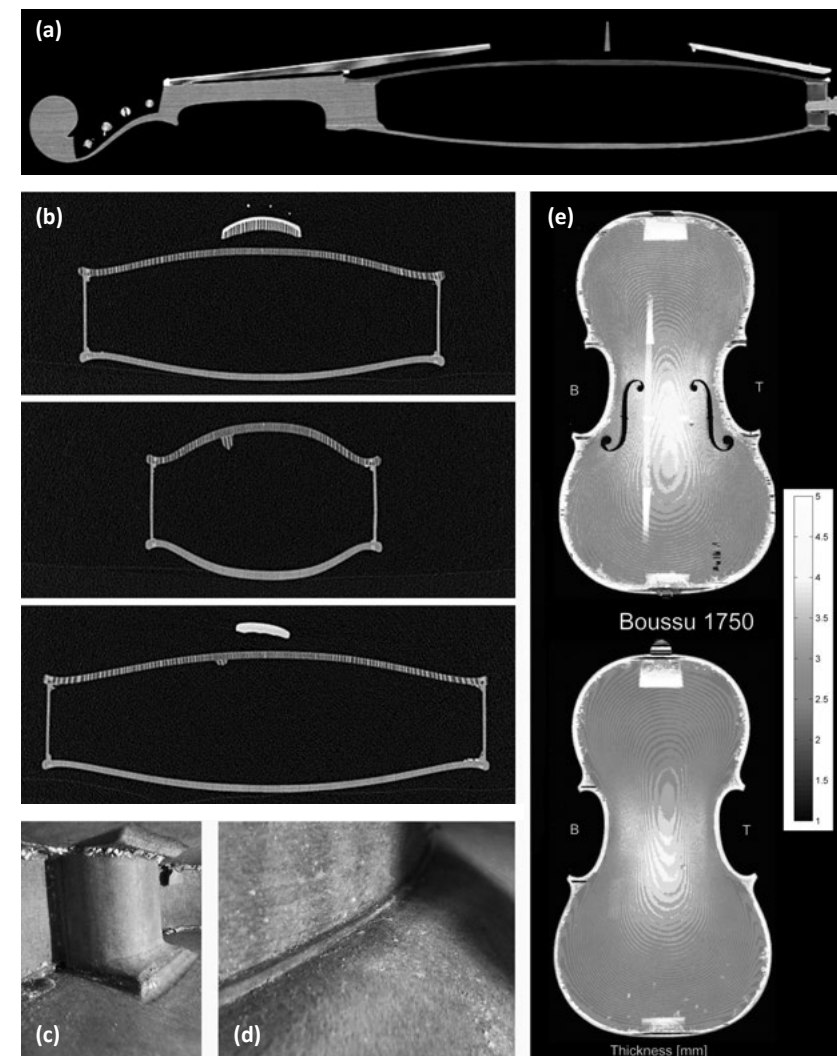

Fig.1 Examples of CT reconstruction and endoscopy images for Boussu violin MIM inv. no. 2781: (a) longitudinal CT cross section, (b) three axial CT cross sections of the sound box, (c) endoscope image of the upper block, (d) endoscope image, detail of lining, (e) thickness maps of top and back plate derived from CT data, scale in mm (maps produced by Dr. Berend Stoel, images originally in colour).

With the newly gained insights, deduction of Boussu's methods of violin- and cello-making could be attempted. Certainly, he made his instruments with a neck and upper block from a single piece of maple, as can be seen undisturbed in violin MIM inv. no. 2781 (see **Fig.1(a)**) and cello MIM inv. no. 1372. This observation, in combination with the presence of a small but noticeable foot on the upper block, supports the hypothesis of a making system without a full mould. Such irregularly pre-shaped upper block could never be temporarily glued to an inner mould, while the protruding neck would not allow the use of a full outer mould either. Instead, Boussu presumably built from the back plate upwards, using the contour of the plate as a guide for the final shape of the sound box. Given the high degree of symmetry and dimensional uniformity of the back plate contours of this maker's violins, it is most likely that the back plate's outline was drawn in the initial stage of making the plate, using a half-template that could be flipped over the central longitudinal axis of the joined and planed maple board, thus yielding perfectly identical left and right halves of uniform dimensions. After the back plate was completely formed and hollowed, the neck could be glued on, a job that had to be done with some sort of aid to ensure that the neck would be assembled in the direct extension of the back plate's central axis. Several possible versions of this aid can be imagined, although some further clues in Boussu's instruments point towards a certain variation.

A very peculiar feature of this maker's violins is the highly identical ear-to-ear width of the scrolls. For example, the five original scrolls on the instruments from the MIM collection have scroll widths of 36.5, 36.0, 36.0, 36.5 and 35.8 mm (average: 36.2 mm, standard deviation: 0.32 mm). Other violin scrolls by this maker on instruments in private ownership show very similar widths. Of course, this precision could have resulted from the maker's apparent strict routines (the back plate lengths of his many surviving violins have a typical uniform length of 361 to 363 mm), but the uniformity of the scroll widths could also have had a functional reason: this dimensional similarity made me think of an alignment table which included some sort of fixture to receive the scroll, the width of the fixture opening being the standardized scroll width of around 36.5 mm. My interpretation of such a table, or work board, is depicted in **Fig.2**. The back plate can be clamped on this table, aligned with the table's centre line, and after that, the completed neck (including upper block) can be positioned in appropriate alignment and glued on.

As a next stage in the proposed making sequence, one pre-shaped lower block and four corner blocks could have been glued on, serving as guides to help position the six rib parts during the next construction step. In this consecutive step, the pre-bent rib parts may have been glued to the blocks and the back plate, subsequently followed by

Fig.2
Fig.3

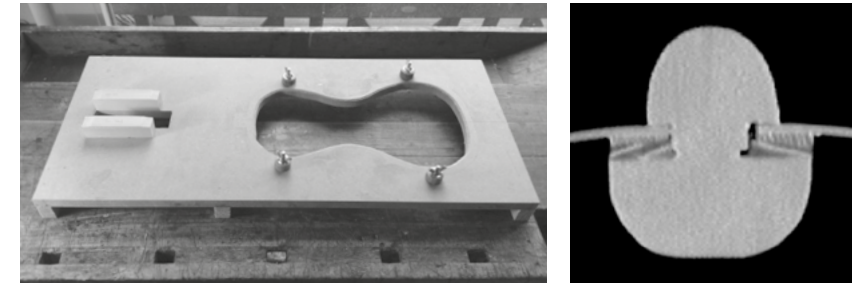

the application of linings where ribs and back plate meet. However, another observation, regarding the rib structure, made me reconsider such working order. In several of the earliest Boussu instruments, from 1749 until around 1751, very small original linings are present at the connection between the plates and ribs, whose cross sections can approach dimensions of only around 1.5×1.5 mm, see **Fig.1(d)**. Most violin-makers would agree that it would be impossible to apply such small-sized linings at the junction formed by the ribs and back plate, due to their tendency to warp during the gluing process, and the inability to properly clamp them. Moreover, the linings are not inserted in the corner blocks, but have feathered ends that always seem to terminate a little before touching the blocks. From these observations, another way of assembling the rib parts and linings is proposed. It may have been possible that Boussu employed "partial outer moulds": a separate mould for each rib part. A maple strip, to become a rib part, could be bent and clamped on such form, and after it maintained its curved shape upon drying, linings could be glued on. After planing the resulting rib part on either side, including linings, to the appropriate height, the stable pre-formed part could be glued upon the back plate. This procedure had to be performed six times in total to form the entire rib structure. Although in later Boussu instruments (c.1752–1761) more robust linings are observed (around 2×5 mm), I presume that Boussu did not change his way of making the rib structure due to the change in lining dimensions.

At the neck-to-body connection, Boussu inserted the upper rib parts into pre-sawn slots in the neck root, and secured them by two complementing wedges on either side, see **Fig.3**. At the rib corners of original instruments, the rib parts are joined in a mitre joint instead of an overlapping one. Another common feature found on almost all examined

Fig.2 Alignment table as made and used by the author for making the two 2017 violin replicas.

Fig.3 Coronal CT reconstruction of the upper block area of Boussu violin MIM inv. no. 2781, showing the inserted upper rib parts and wedges securing the rib parts into the neck root.

Fig.4

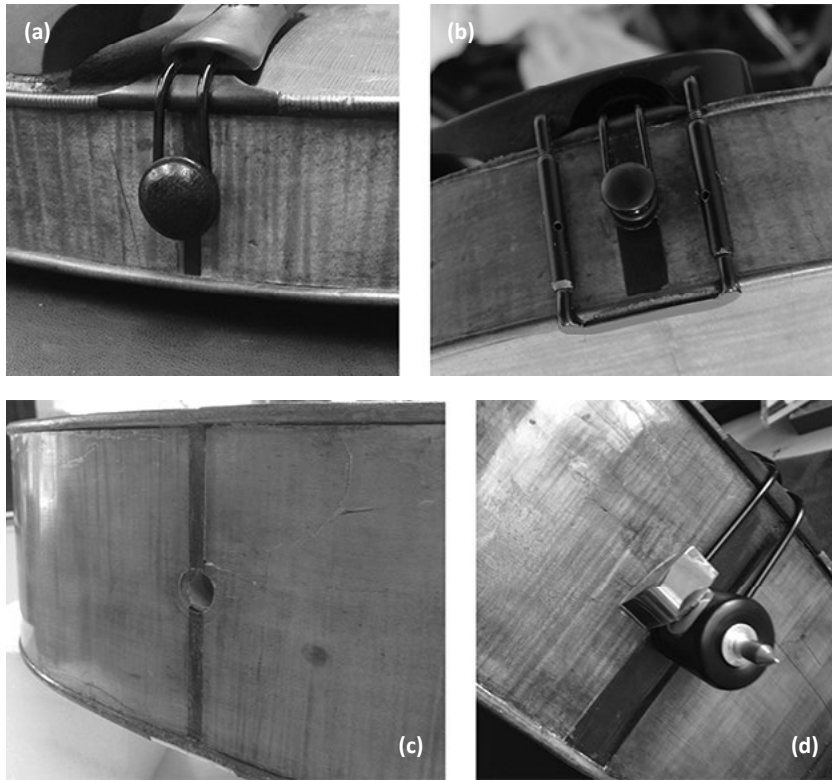

Fig.4 Examples of filler strips at the underside of original Boussu instruments: (a) violin in private ownership, (b) viola in private ownership, (c) cello MIM inv. no. 1372, (d) cello in private ownership.

original instruments is a glued-in strip, often of a dark hardwood, where the two rib parts of the lower bout meet at the bottom block, see **Fig.4** for several examples. The width of this strip varies from instrument to instrument, an indication that Boussu employed such a strip to compensate for variations in length of the pre-fabricated lower rib parts.

The violin-in-progress now contained a back plate, neck and sides, so the only part missing from the basic structure would be the top plate, which could be made and attached by Boussu in the common fashion. Regarding the bass bar of the violin MIM inv. no. 2781, an interesting observation can be made. First of all, with a maximum height of 7.0 mm, a width of 5.0 mm and a length of 234 mm, this bar is believed to be original. What is even more striking is its placement: rather angled with its longitudinal midpoint coinciding exactly with the position of the bridge, see **Fig.1(e)**. Interestingly, an identical positioning of the bass bar in respect to the bridge position is found in cello MIM inv. no. 1372. Various carefully scratched-in marking lines, applied during the construction process, for example on the back of the peg box, confirm the systematic and precise habits of this maker.

As explained earlier, the obtained CT scans provide unprecedented information regarding the internal construction of Boussu's instruments and even allow for the performance of any dimensional measurement within the CT visualisations with the use of the appropriate software (in our case the software package Osirix was used). Even more, scale 1:1 cross sections can be produced from the CT data, which in printed form could serve as accurate construction drawings, while medical imaging specialist Dr. Berend Stoel provided his kind cooperation by constructing thickness, arching height and density maps for several instruments' top and back plates (for examples, see **Fig.1(e)**). Of note are the unusually similar thickness patterns for the top and back plate, with the top being relatively thick in the centre, another concept Boussu apparently developed from being an autodidact. Maps as produced by Dr. Stoel provide indispensable information during an instrument reconstruction or replication process.

As said, the CT scan reconstructions provide plate thicknesses and longitudinal and transverse archings profiles at any cross section, while also allowing for the performance of additional "virtual" measurements, thus avoiding any physical contact with the original instrument.

3.3 Project Phase 3 – Instrument Construction

With the aid of all this new information and insight obtained, the construction of a second pair of violin replicas was commenced in early 2017. The working sequence employed during the making process was exactly as explained above; several representative steps are illustrated by the photographs in **Fig.5(a)** through **(d)** and **Fig.6**.

Fig.5

Fig.5 Several representative steps in the 2017 construction process of a violin after Boussu: (a) marking the back plate contour (template produced from CT data), (b) gluing the neck to the back plate using the alignment table, (c) making the rib parts on partial moulds, clamping is done by rope, (d) gluing the rib parts, including the linings, to the internal blocks.

Fig.6
Fig.7

After the two new replicas were finished “in white”, the appropriate varnish had to be decided. A true chemical analysis to identify the organic components of Boussu’s varnish has not yet been performed, and whereas that would be an interesting exercise, it has been previously suggested that Boussu applied a shellac based varnish [7]. This assumption was confirmed by our investigations of Boussu’s varnish with the use of UV light: a bright orange fluorescence, characteristic of shellac, is observed on both the entire violin MIM inv. no. 2781 (see **Fig.7**) and the cello MIM inv. no. 1372, with original varnish even still present on the necks.

Based on this observation, it was decided that the two violin replicas would be finished with a varnish based on raw sticklac, with the addition of some dragon’s blood resin (for colour adjustment) and some sandarac and elemi to temper the hardness of the shellac. The golden brown colour of this varnish showed convincing similarity with the varnish on the original instrument, although it proved hard to achieve the same level of evenness in colour and surface smoothness in comparison to Boussu’s examples. **Fig.8** shows both the original violin as well as one of the copies made in 2017. In late 2017 and early 2018, a cello replica after the original, unmodified Boussu cello MIM inv. no. 1372 was built, based on a CT scan (made by Prof. Coche and Prof. Danse and their team in the Brussels Saint-Luc hospital) and using a similar working sequence as was employed for the violins. For all three replicas, the making process was captured in detail on video, and an edited version of this footage has been made available on the YouTube channel “Boussu_Inside_Out”¹, in order to further disseminate knowledge regarding the construction process.

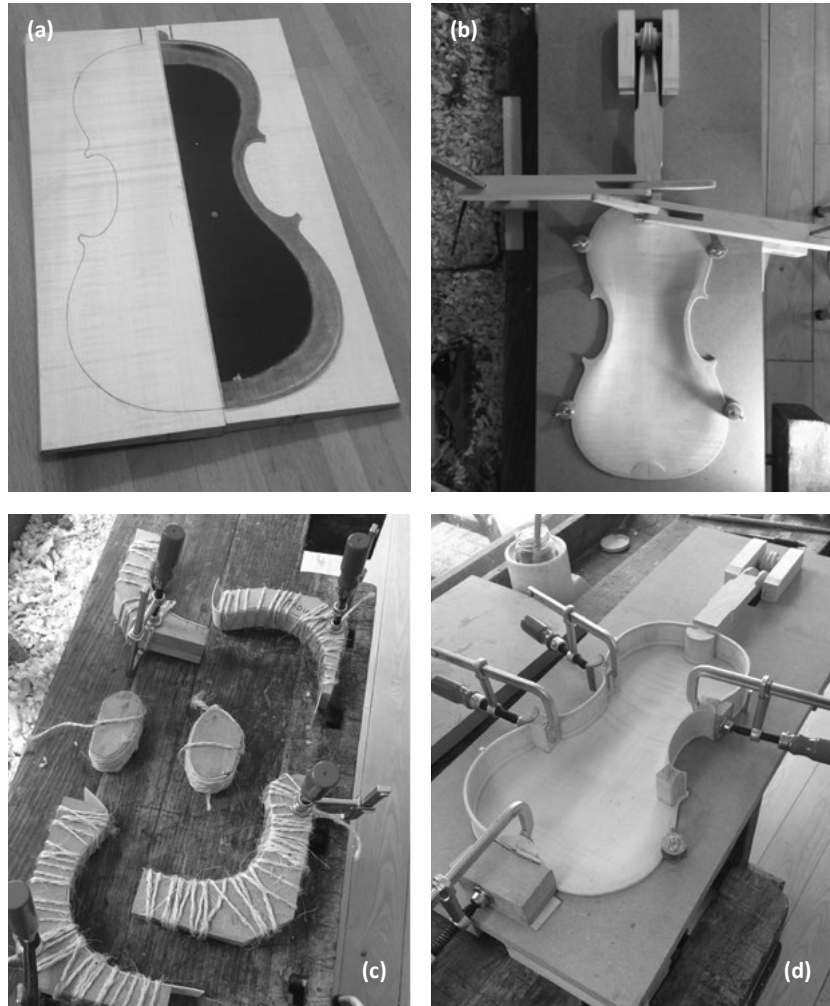
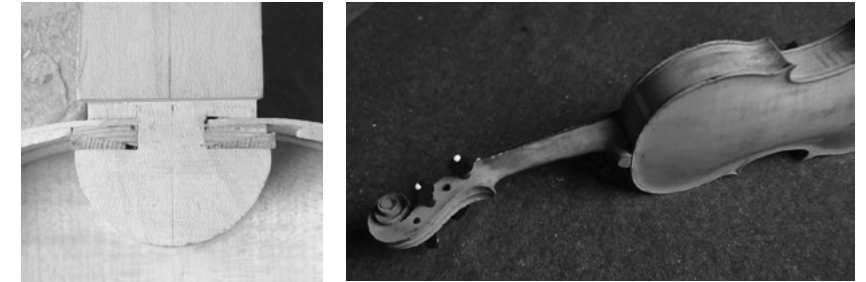
¹ https://www.youtube.com/channel/UChivkXPogBhUIj3X2I_DFVA

Fig.6 Detail of a violin replica in progress, showing the upper block and the wedges to secure the rib parts into the neck root.

Fig.7 UV-induced fluorescence of the varnish on original Boussu violin MIM inv. no. 2781.

Fig.8



Fig.8 Original vs. copy: (a) original Boussu violin MIM inv. no. 2781 (Photo: Musical Instruments Museum, Brussels, © KMKG), (b) violin replica made by the author in 2017 (Photo: Jan Stragier, School of Arts Ghent).

For the most part, the building sequence employed and at the same time evaluated during the making of the current violin and cello replicas proved efficient and convenient, whereas the resulting replicas showed a great similarity to the original instruments, both in overall appearance as well as regarding weight and maker-specific constructional details. In general, the construction process progressed smoothly, and the employed making sequence allowed for a logical and effective working order. In case of the cello, however, the assembly of the rib structure took more time and effort than expected, especially to ensure a symmetrical and perpendicular alignment of all rib parts. Nevertheless, this step may progress more fluently during a future cello construction, due to gained learning experiences. Furthermore, Boussu may not have employed a working table exactly resembling the one used during the current replications, but I believe it is highly likely that his workshop contained an aid with a very similar functionality. In all probability, it may thus be concluded that Boussu employed a comparable construction system as tried out during the current replication process. The parallel making of the two violin replicas, up to the unvarnished state including the veneered fingerboards, took 80 effective working days in total, thus 40 working days per instrument. For the cello replica, 70 working days were needed to complete the instrument “in white”. This may seem long, especially in comparison to the output rate of Boussu (see hereafter), but with the gained experience and know-how, it should be possible to make a future copy in a somewhat shorter time span. Moreover, as will be explained below, Boussu most certainly did not work alone in his workshop.

As said before, the dimensions of original instruments show a very high degree of uniformity. Furthermore, especially in his earlier instruments, Boussu included an internal inscription containing detailed information such as his name, the date of signature to the day, the place of production and a serial number. Such precise, almost obsessive habits could have resulted from his personality, which may have been somewhat compulsive, but also from his background as a notary.

In his notary profession, which he practised for almost 20 years, precision and punctuality must have been valued qualifications. Additionally, the uniform dimensions of Boussu’s instruments may also point towards a standardized and even modular production process. Given Boussu’s high production rate, especially during his initial years as a luthier (according to the numbering on his labels, between 1749 and late 1752 he produced 36 violins and at least 6 cellos), it is unlikely that he worked all by himself. More plausibly, he headed a workshop with a few employees, maybe two or three persons, who all had more or less fixed subtasks within the production process, such as preparing the boards and blocks for plates and necks, pre-bending the rib parts

(as explained above), and varnishing. His two eldest sons, Pierre Antoine and Jean François, both in their teen years during the 1750s, could very likely have been amongst the workshop personnel. Both these sons became silversmiths in their later life, so we know they must have been able to perform craftwork. The more refined tasks, such as carving the scrolls, shaping the plate contours and archings, as well as purfling and finishing, may have been done by Boussu senior himself, since we consequently observe a single, highly recognizable and secure hand in these more aesthetic aspects of his instruments. It may be noteworthy that he was familiar with the advantages of modular and serial working from his days as a notary, where handwritten acts were often copied in advance from formula books, leaving specific information such as client names and dates open to be filled in later.

The use of such efficient modular and cooperative methods ensured prolific output, with a high degree of quality and uniformity. In this respect, it must be remembered that during the middle of the eighteenth century, under the influence of the rationalism of the Enlightenment and on the verge of the industrial revolution, strong developments were about to happen in all branches of product manufacturing. In this climate, with the introduction of Watt's first commercial steam engine just decades away, the instrument-making sector may have undergone changes as well, towards a more industrialized mode of production. These prosperous economic and social conditions aside, Boussu's entrepreneurial spirit may also have helped him achieve commercial success in the violin trade, although he must have had financial security and backup in the form of proceeds from investments in his native region.

3.4 Project Phase 4 – Musical Performance

In the final stage of the current research project, in progress during 2018 and 2019, the three instrument replicas will be set up in collaboration with Ann Cnop, Shiho Ono and Mathilde Wolfs (see **Fig.9**), experienced performers of eighteenth-century music, and these musicians will subsequently use the instruments to perform Brussels repertoire from the time of Boussu, in order to assess playability and musical and sonic possibilities. Performances during this final phase will be captured by both audio and video recordings, and public concerts will be organised. Examples of recordings of the musicians playing the replica instruments are available on the YouTube channel "Boussu_Inside_Out".

With respect to the repertoire to be performed during this concluding phase, we selected little-known and rarely performed Brussels chamber music of the mid-eighteenth century, such as trio sonatas by Henri-Jacques De Croes, Pieter Van Maldere and Eugène Godecharle. Additional repertoire will be collected through research in Belgian

Fig.9
Fig.10



music archives and private collections, in collaboration with Dr. Bruno Forment and Dr. Anne-Emmanuelle Ceulemans.

One specific musical focus relates to the performance of the Brussels trio sonata repertoire with only three bowed stringed instruments. Although many present-day performances of similar, more well-known repertoire are, as an unwritten rule, performed with the accompaniment of a polyphonic instrument—mostly a harpsichord—the current study aims at performance experiments with the cello as sole accompanying instrument. A substantial number of original mid-eighteenth-century trio sonata editions prescribe a basso continuo of “harpsichord *or* violoncello”, as is the case, for example, with the c.1752 edition of Van Maldere’s “VI. Sonatas for two violins with a thorough bass” [8, 9] (see **Fig.10**). This implies a forgotten performance practice featuring only the cello as accompanying instrument, as also put forward by Watkin [10]. Possibly, the publishers of such printed music hoped to sell more copies by also addressing musicians that did not have access to a harpsichord. By performing the music with just a bowed string trio, we want to explore the sonic and harmonic implications of choosing that particular, currently overlooked setting.

Fig.9 Musicians Ann Cnop (left), Mathilde Wolfs (middle) and Shiho Ono (right) with the replicas.

Fig.10 Title page of the first edition of Pieter Van Maldere’s “VI. Sonatas for two violins with a thorough bass for the harpsichord, or violoncello” (Willy Van Rompaey collection).

The musical performance phase provides a sensible, sounding and satisfying way to round off this study on the life and creative output of the maker Boussu. With respect to a possible future continuation of the research, various additional scientific investigations, such as a true chemical analysis of his varnish using gas chromatography methodology and wood dating through dendrochronology, could be performed to further complement the knowledge regarding the instruments of Boussu.

4. Conclusion

In the past, makers have been firmly involved in examining and copying historical instruments. This tendency only grew stronger with the emergence of the “Early Music revival” in the middle of the twentieth century, when the demand for truly faithful instrument replicas increased. Although makers thus developed many initiatives, written scientific output documenting their efforts remains scanty, a few exceptions aside.

This essay has advocated for the emancipation of makers towards full-fledged organological scholars, or at least for bridging the gap between the worlds of academia and craft. The makers’ unique understandings, experiences and practical abilities can be beneficial additions to the field of musical instrument research, if only they were prepared to strengthen their academic competences, including the adaptation of scientific methods and practices and the publication of results through the appropriate channels.

As argued, a maker’s “workbench research”—the production of actual reconstructions or replicas including the assessment of proposed making techniques and procedures—is especially valuable, since makers form the only group within the instrument-studying community capable of conducting these kinds of performative methodologies. Such activities, comparable to those performed during experimental archaeology, will always evoke new questions, and therefore, the making process itself is just as important as the tangible products it creates or studies; practical experimentation enables the liberation of embedded or silent information contained within the objects under examination. The knowledge thus unleashed will partly manifest itself immediately, and partly precipitate slowly in years to come.

The case study presented is intended to illustrate the concept of “informed instrument making”, where eventually replicas (or reconstructions) are built based on a profound and multi-faceted research of instruments, methods and biography of a maker, ultimately in function of the musical performance practice. Judging from this presented case, the many resulting and fruitful collaborations with leading experts in various fields—radiologists, law historians, musicologists, performers—confirm that instrument (re-)construction

can indeed act as the catalyst as well as the adhesive for multi-disciplinary organological research projects. One may even go so far as to state that an exertion delving so deeply and comprehensively into the life and output of an original maker will not merely produce a replica, but a “new original”, as if the present-day re-constructor had the opportunity to apprentice—seemingly beyond time-barriers—with the original maker. Following this reasoning, the resulting product of such a process should be the ultimate “authentic performance tool”.

Furthermore, by performing and publishing such multi-faceted study on a relatively unknown maker like Boussu—who may be considered a mere footnote in instrument-making history by those who are commonly more attracted to the famous stars of the trade—the author hopes to inspire future research into the lives and work of some other minor gods of lutherie, to be able to bring the whole story, not just the glamorous side.

On a personal note, my own academic formation in chemistry may have helped in the adoption of a scientific approach in instrument research and making. Would things have been different without this background? That question is hard to answer. Maybe curiosity, dedication, perseverance, an open and analytic mind and the willingness to generate and distribute new knowledge are much more important than any form of academic education. And the luck of being both a bit of a “doer” and a bit of a “thinker” by nature...

ACKNOWLEDGEMENTS: My thanks go to my promotors, Dr. Francis Maes (Ghent University) and Dr. Geert Dhondt (School of Arts Ghent), for their supportive guidance during my Ph.D. research project “Boussu Inside Out”. I also want to thank the MIM staff for providing access to the Boussu instruments and assistance during the instrument examinations, with special mention of stringed instruments curator Dr. Anne-Emmanuelle Ceulemans, who also provided her expertly and encouraging advice and guidance in the Ph.D. project, and Joris De Valck, Simon Egan and former staff members Guy Buyse and Manu Frederickx. My gratitude further goes to co-promotor Dr. Bruno Forment and musicians Ann Cnop, Shiho Ono and Mathilde Wolfs for their wonderful contributions to the research project “The sound of Brussels anno 1760”. Karel Moens recommended me to study the Boussu violin MIM inv. no. 2781, which marked the beginning of my quest for its maker’s biography and output. I thank the many private owners, musicians as well as collectors and dealers of Boussu instruments for allowing me to study their treasured possession. CT scanning and data interpretation would not have been possible without the expertise and generous support of Prof. em. Danielle Balériaux, Dr. Berend Stoel, Dr. Tom Van Hoof, Dr. Emmanuel Coche, Dr. Etienne Danse and their hospital staffs. During the biographical research, Prof. em. Véronique Demars-Sion, Dr. Georges Martyn, Alexis Donetzkoff and Romain Le Gendre kind-heartedly provided their valuable help and advice. I also thank Willy Van Rompaey for giving me access to his personal sheet music library. The research project involving the performance on the instrument replicas has received a two-year research grant from the School of Arts Ghent. WoodMusICK COST Action FP1302 provided a STSM grant to support part of the archive research. I am grateful for both grants.

References

- [1] B. D. Sherman, “Authenticity in Music,” in M. Kelly, Ed., *Encyclopedia of Aesthetics, Vol. 1.*, 1st ed. Oxford: Oxford University Press, 1998, p. 167.
- [2] N. Wilson, *The Art of Re-enchantment – Making Early Music in the Modern Age*, 1st ed. Oxford: Oxford University Press, 2014, p. 72.
- [3] G. Verberkmoes, “Benoit Joseph Boussu (1703–1773): Violin Maker and Notary,” *The Galpin Society Journal*, vol. 66, pp. 117–138, 262–264, 2013.
- [4] G. Verberkmoes, “Made in Amsterdam: A Cittern by Benoit Joseph Boussu,” *Early Music*, vol. 44, no. 4, pp. 628–630, 2016.
- [5] G. Verberkmoes, A. E. Ceulemans, D. Balériaux and B. Stoel, “An Inside Look at Four Historical Violins by Brussels Makers,” *The Galpin Society Journal*, vol. 69, pp. 109–136, 159–165, 2016.
- [6] G. Verberkmoes, “Made in Amsterdam: A Cittern by Benoit Joseph Boussu,” *Early Music*, vol. 44, no. 4, pp. 635–638, 2016.
- [7] K. Moens, “Vioolbouw in de Oostenrijkse Nederlanden,” *Arca Lovaniensis*, vol. 10/b, p. 152, 1983.
- [8] P. Van Maldere, *VI. Sonatas for Two Violins with a Thorough Bass for the Harpsicord, or Violoncello*. Dublin: author, c.1752.
- [9] W. Van Rompaey, *P. Van Maldere – Thematische Catalogus van de Instrumentale Werken*, 1st ed. Aartselaar: author, 1990, p. 23.
- [10] D. Watkin, “Corelli’s Op.5 Sonatas: ‘Violino e Violone o Cimbale’?,” *Early Music*, vol. 24, no. 4, pp. 645–663, 1996.

Material or Immaterial?

A Questionnaire to Help Decisions About the Preservation of Musical Instruments

VERA DE BRUYN-OUBOTER

Ringve Music Museum, Trondheim, Norway

Abstract

This questionnaire is a tool for assessing whether individual musical instruments belonging to a museum's collection may be played. The questionnaire is intended to help assess the risk of material loss when the instrument is played against the loss of immaterial aspects when the instrument is not played.

Material loss means damage to and alteration of parts, often caused by the mechanical stress and forces incurred through long-term playing. Immaterial loss includes loss of the sound of the instrument as passed down through the generations. If not played, the sound vanishes and is no longer available in the hearing of today or in the memories of yesterday.

To preserve both the material and immaterial aspects of an instrument is in most cases contradictory and presents a dilemma. The importance of both aspects should be evaluated when considering the preservation of each individual instrument. Several aspects should be taken into consideration when making this evaluation. These aspects form the basis of the questionnaire being translated into single points. The resulting outcome of the questionnaire is intended to help take the decision of whether to play or not to play. At the same time, completing the questionnaire is meant to raise awareness of the various aspects involved in the dilemma.

1. Introduction

Museums must ensure that all objects and collections are managed professionally and in the interests of the public. This includes securing all aspects of the collection's preservation for the future. Musical instruments carry both material and immaterial values that should be preserved for future generations.

Earlier publications [1, 2] on the subject of conservation formed the basis for the development of this questionnaire. Here, the attempt is made to transform essential aspects of the conservation of musical instruments, a field well known and discussed among specialists, into a terrain easily accessible to anyone. By posing simple questions, the reader is not only drawn into the field but also given the opportunity to form judgements.

When played over a long period of time, musical instruments always show changes: they are damaged and repaired, sometimes by simple wear and tear. In order to delay this alteration of the instruments as much as possible, playing must be subject to control. Playing subjects the instrument to stress and, as such, is the main cause of change in the substance of the instrument.

Today, two opposed points of view are put into practice: either playing is completely prohibited or instruments become utility objects that may be played without limitation. In some situations, parts of collections are kept unplayed and untouched while others are played, sometimes daily. When playing is excluded (also in the more extreme cases of instruments that are not in playable condition), the idea is to secure the entire material substance and technology of the instruments for future generations. For other parts of collections, a more open attitude towards playing is put into practice. This can include the invasive maintenance, repair and modification of instruments in order to allow sound to be heard, as with instruments belonging to musicians. Special occasions such as anniversary concerts are often the moments for making an instrument "work as it should". This sort of change in favour of playability is characterized by an attitude that regards materials a specific instrument is made of as interchangeable. Old broken strings for instance must be replaced if the concert is to take place.

In this type of individual case, and in fact in all cases, it may be said that it is the museum's responsibility to assess the ethical questions involved, to evaluate the advantages and disadvantages of modifying the instrument. In each specific case, the question will be: what will be the material loss of taking off the old broken strings, and what will be gained by putting on new ones? The present questionnaire aims to provide a simple means of systematically pursuing the answers to such questions, to raise awareness of these ethical questions, and to help obtain sound judgement.

The *Material Immaterial Questionnaire* supports communication and decision-making in core questions about the playability of instruments in museum's collections. The questionnaire considers and evaluates the risk of immaterial loss, such as playing the instrument, against the risk of damage and change to the materials.

2. Preparations and Getting Started

The questionnaire [see Appendix] is designed in such a way that it is carried out in cooperation between curator and conservator/restorer. The team is supported by the involved musician, education staff and if necessary, other specialists.

The questionnaire is to be used for a single instrument. It can be used for all types of musical instruments in museum collections that are included in collections as objects of historic interest and conservational value.

In each case, a number of things, presented in the checklist below, should first be clarified before starting the questionnaire. Going through the checklist beforehand should prevent any unreflected activity. In some cases, the checklist may raise awareness of the situation, leading to cancellation of the proposed use of an instrument for playing.

The below checklist is to be seen as preparation for the questionnaire. Make comments for each of the ten following statements and if possible obtain the information needed from supporting documentation.

CHECKLIST

- I. The playing situation is clarified: how, who, how often, when, where and what will be played. [3]
- II. The desired playable condition of the musical instrument is clarified with the museum staff and with the player together.
- III. The museum's standards concerning climate control, transport, security and handling will be met at all times.
- IV. A condition report concerning the materials and the functioning of the instrument will be prepared.
- V. Research into earlier treatments of the instrument will be undertaken. The extent to which the sound has been affected by treatments and changes caused by time should be estimated.
- VI. A proposal for the necessary work to achieve the desired state of playability should be made and assessed according to the ethics of conservation [4]. "Necessary work" includes restoration, conservation and maintenance work.
- VII. An assessment of the instrument's significance [5, 6] is prepared. This includes reflections on the provenance, uniqueness, historical

and cultural meaning, local / national / international relevance, importance for researchers or other groups now and in the future.

- VIII. An investigation should be made into the existence of both earlier or similar audio recordings and similar playable instruments or instrument copies, including consideration of whether these recordings and/or instruments could be used instead of the museum's instrument.
- IV. The ability and knowledge of the performing musician are well known and match the instrument to be played. Similarly, the technical level of the recording equipment and surroundings need to match the desired outcome.
- X. A time / cost calculation of all expenses arising from the project is available and has been accepted by the museum management.

Below are some additional details relating to the ten points in the checklist that might help to clarify the situation and procedures:

1. Is it a one-time recording / concert, or is the instrument to be used by a guide on a regular basis for demonstration purposes?
In some cases, researchers want to dismantle instruments. In such cases, the same restrictions apply as for playing. Sometimes an instrument is used or presented for non-musical purposes. The bellows of an organ may for instance be presented to show how bellows work. Again, the same restrictions and rules apply as for playing and measuring instruments.
2. To avoid disappointments, all those concerned, especially the player, should agree on the condition in which the instrument should be for playing. Sometimes, from the museum's point of view, it may not be possible to bring the instrument into the condition expected by the player.
3. It must be made clear to all concerned that the use of the instrument and the activities surrounding the use of the instrument take place according to the museum's policies concerning handling, transport, security and climate control. The standard rules according to the preventive conservation of museum objects should be respected. For instance, in the transport of the instrument to the place where it is to be played, the museum's requirements with respect to climate and security must be met.

Once this important background information (1–3) has been established, further preparations can begin.

4. A condition report of the instrument—its materials and its functioning—is prepared by a conservator. Based on the condition re-

port, a treatment proposal is made in relation to the proposed use of the instrument. The examination and treatment proposal may require the involvement of specialists such as instrument-makers and musicians. These specialists must be informed about the museum's preservation rules and the aims of the project.

5. In some cases, the museum will hold records of previous work done to an instrument. In other cases, past research may reveal changes made to the instrument in the past. An obvious case is that of a seventeenth-century harpsichord changed in the eighteenth century. The changes to the sound can be roughly estimated. If a recording is to be made of such an instrument, knowledge of this change might mean that recording seventeenth-century music would not be appropriate.
6. If the process reaches the stage at which those involved agree on the changes that have to be made to the instrument, the steps required to execute these changes should be clearly set out. The museum's curator and conservator should then examine this proposal and assess it critically in light of the ethics of conservation.
7. The historical significance of the object is specified. Is it a one-of-a-kind piece, technologically speaking? Does it have a special connection to a particular event or person? Is the provenance known? The relevance and significance of the instrument for international, national, regional and local groups, communities or organizations also have to be considered.
8. The following should always be asked: is it an object with many similar examples in other museums? There may be instrument copies or other historic, playable instruments that could serve the same purpose as the one proposed and thus avoid the treatments proposed and stress on the instrument. If a recording is to be made that involves change to the instrument (including wear and tear), there should again be awareness of whether there are other sound / video recordings that could be a substitute for playing on the particular instrument. If there is a substitute, it could be used in order to avoid the changes to the instrument that the proposed project might entail. However, the suitability of the substitute in terms of quality and modern standards has to be assessed.
9. Who is chosen as the musician to play the instrument (a professional or an amateur), and more importantly, is the musician well suited to do justice to the instrument? It may even be that a lesser player allows the instrument to be heard in a way that is more representative of the way the instrument has usually been played. It is, for example, not safe to assume that all concert pianists, used to big grand pianos, are familiar with changing their technique to play a clavichord.

If an audio recording is made, the quality of the recording and the extent to which it will be representative of the sound of the instrument has to be considered in advance. A wide range of factors may change the sound of the instrument in a recording. If audio engineers can be involved, they will help to make decisions and explain possibilities. If, for example, the aim is to achieve a historic “picture” of the sound of chamber music, then the acoustics of a smaller room should be used.

For recordings, the aim should be clearly agreed. In principle, the unique, characteristic sound of the instrument should be captured in order to have the sound of the instrument recorded and thus available and accessible for the public. If the recording does not faithfully represent the original, it makes no sense to make a museum’s instrument playable, a process that can be costly and arduous. To make a faithful recording requires expertise. The project must involve a person with this expertise and someone, perhaps the same person or the musician, to evaluate the faithfulness of the recording.

10. Before the project starts, a time / cost evaluation of the entire project (restoration / conservation work, transportation, audio recording, musicians, specialists, etc.) should be prepared and approved by the museum management.

3. Questionnaire

Going through the checklist should then allow the questionnaire (Appendix, **Tables 2** and **3**) to be completed. The *cover sheet* is filled in (Appendix, **Table 1**). The statements in the *material* [**Table 2**] and *immaterial* [**Table 3**] sections are answered by ticking “true” or “false”.

At the end, the resulting points are added together and the two sections are compared: more points in the immaterial section indicates a risk of immaterial loss. In this case playing / making the instrument playable may be approved. More points in the material section indicates a high risk of material loss. In this case, the instrument should not be played / made playable.

In short: High score in *material* table = no playing;
High score in *immaterial* table = playing.

The score from the *material* table and *immaterial* table can be entered on the *cover sheet* [**Table 1**] for comparison. Use the questionnaire as a structured support that broadens the basis for decisions of the following procedure. Below is more detailed information about the statements in the *material* and *immaterial* sections of the questionnaire.

MATERIAL QUESTIONNAIRE [**Table 2**]

Questions 1 – 4 are related to direct work on the instrument through a conservator / restorer. Wrong decisions in conservation / restoration can represent a risk of material loss.

1. *The instrument’s condition can be assessed without material loss.*
In some cases, it is not possible to study playability from the exterior without material loss. This can involve damage to the surface or to constructional parts. Only non-destructive methods for examination should be used. If this is not possible, the project should not be continued.
2. *Only minor treatments are necessary to bring the instrument into playable condition.*
Treatments for making an instrument playable should change the object as little as possible. If all treatments to make the instrument playable are easily removable and truly processible [7], the risk of material loss is low.
3. *No treatment is required that increases the risk of damage to the material of the instrument in the long term.*
It is possible that requests arise for treatments that are traditional, but that these treatments may then result in long-lasting destructive chemical corrosion or generate forces on the inner material structure. This is the case, for example, when oiling a flute from the inside or using oil or grease on the mechanical parts of instruments.
4. *Parts that must be removed and/or replaced have no significance to the instrument now or in the future.*
This question must be answered on the basis of the results of the historical context and the object’s significance. If there are parts “loaded” with value, a high risk of loss of value exists within the risk of material loss.

Questions 5 – 7 are related to the condition of the specific object concerned and its ability to withstand mechanical stress and forces.

5. *All parts are stable and free of signs of degradation.*
The prepared condition report will give the answer to this question.
6. *The impacts and forces involved in playing the instrument are controllable at all times.*
If the forces can be controlled, risk is lower than when they cannot

be controlled. One example is the playing of a drum: the musician controls the forces at all times. A contrary example is connecting an electrical instrument to a power supply. The risk of electricity destroying inner parts could be lowered by a regulator, lessening the amount of power delivered. This increases the amount of control and lowers the risk of damage.

7. *No parts are likely to be damaged by the impacts and forces related to playing.*

This is about which parts break, tear, deform or could be damaged by playing. The load capacity must, if possible, be calculated and measured in order to present an objective result. If that does not work, then the stress in each situation has to be estimated as precisely as possible. If the risk is very high, there is also a high score here. For example, deformations of stringed keyboard instruments when tuning can be calculated and measured on keyboard instruments [8]. Wear and tear on pivot points (also on wind instruments) are harder to estimate but should be kept in mind, especially when the aim is to repeatedly use the instrument.

Questions 8 & 9 are related to documentation. If the object's material basis, functionality and measurements are well documented, any loss of material is easier to estimate.

8. *Research has been done on materials and functionality. All results are well documented.*

Existing records of the way the instrument is made and its wood, metals, papers, leathers, pigments, traces of tools etc., will preserve knowledge of the object's material properties.

9. *Documentation of all measurements of the instrument exist in form of technical drawings, x-ray or CT scan.*

If a copy is to be made, documenting all measurements is essential for the production of copies.

IMMATERIAL QUESTIONNAIRE [Table 3]

1. *The sound of the instrument type is well known and readily available.*
The risk of oblivion of the sound is low if the instrument type is widely available in media or concerts.
2. *The playing is not part of an exhibition, publication or other project intended to reach the public.*
A planned event around the playing that reaches the public raises the number of people who are familiar with the sound. In the big picture, this fortifies the sound in the collective memory and lowers the risk of losing the sound as part of cultural heritage.
3. *A similar instrument / copy / replica could be used for the planned playing.*
If prior investigation discovers existing copies of the instrument to be used, such copies should certainly be considered as substitutes before making another object playable. If a copy exists, the risk of losing the sound in the collective memory is low.
4. *The playing will not be recorded.*
Points will be given for saving the immaterial if an audio recording of the playing of the instrument is planned. A recording is available to a far larger audience than is possible in any performance.
5. *There is another recording / concert / outreach project of this or a similar instrument.*
To miss recording a particular instrument that has not been recorded before (especially if the instrument is rare or unique) may be to miss a chance to continue the sound of the instrument as part of our intangible cultural heritage. In such cases, well-documented playing may be considered even if there is some risk of material loss. However, this requires a thorough search to discover existing recordings of the same or similar instruments in other museums (national and international).
6. *The sound has changed through age or intervention such that the instrument no longer plays in a way that is representative.*
When restorations or other changes, for instance through time, have changed the instrument in such a way that its sound is no longer representative of the instrument, then there is a high risk of distortion (loss) of the sound in the collective memory. The aim is to preserve the instrument's sound as unaltered as possible, and points are given to the playing of an instrument that promises to be a faithful representation. This most important question

should be carefully considered. An instrument is a whole, all parts of which contribute to making its unique sound. Furthermore, even the smallest material change can make a big difference in the sound. The sound should have a quality that represents the instrument in a relevant way, matching the instrument's history. Since we cannot know exactly how it sounded previously, as we are not living in the past, nor know very much about the players, the acoustics and the audience, we can only try to come as close possible to an "unaltered" sound [9]. One way to come close is for the parts making up the whole to be intact and unaltered.

Questions 7 & 8 are related to the immaterial skills connected with the musical instrument, which we aim to keep alive.

7. *No improvement of musician skills. Experiences will not be documented or taught.*

A musician plays an instrument using sensory-motor skills. The risk of these skills being lost is lowest if they are taught to pupils, explained to an audience or can be documented in the form of an interview.

8. *No improvement of instrument-maker skills. Experiences are not documented or taught and do not result in producing a copy.*

The skills of an instrument-maker increase through research and feedback from musicians. As with the skills of the musician, the instrument-maker's skills should be documented, disseminated and, in the best case, practiced by building a copy. High involvement and documentation support preservation of the immaterial skills connected with the instrument; points are given for this.

Question 9 is related to knowledge of musical instruments that is extremely difficult to conserve unless they are played.

9. *Even if not played, the object is comprehensible as a musical instrument to the viewer.*

Some instruments remain impenetrable, and their characteristics as musical instruments are extremely hard to understand if they do not sound or are not played. Examples include closed music boxes, or the Theremin, which is impossible to understand unless it is played. The risk of immaterial loss is higher if the instrument is hard to understand until it sounds.

4. Background

The first version of the *Material Immaterial Questionnaire* was called *Risk – Gain Analysis* and was developed in 2010 for a specific project that aimed to make audio recordings of mechanical musical instruments from the collections of the Ringve Music Museum in Trondheim, Norway. In order to apply the questionnaire to all types of instruments, questions were subsequently added. *Risk – Gain Analysis* was in a test phase for several years and was tried out on different musical instruments in different situations and by different users. It has been developed and presented several times in national and international professional platforms.

This most recent version is called *Material Immaterial Questionnaire*. The earlier title *Risk* (material section) – *Gain* (immaterial section) *Analysis* gave preferential value to the material (risky to lose) and less value to the immaterial (gain to preserve). The new title has been chosen to respect the material and immaterial on equal terms. It is a risk to lose either and a gain to preserve both.

5. To discuss

When creating the questionnaire, it was assumed that the values of the material and immaterial are equally important. The material or tangible value is the instrument's material, form and technology. The immaterial or intangible value is the sound, playing function, historical context (important persons or events connected with the instrument), sensory experience for a musician, experience for living traditions of instrument-makers and the listening experience for the listener. The questionnaire demonstrates the risk of losing material value compared to the risk of losing immaterial value. Both need preservation in order to help people of the future to understand and experience the musical component of their cultural heritage.

Material and immaterial values may be closely intertwined. It must be kept in mind that changes in material, form and technology cause intangible alterations in the quality of the sound. It is the material that creates and carries the sound. If the material is changed, the intangible also changes. The material can be experienced by the player, and the material is thus the basis for making the music audible to the listener. With musical instruments, the smallest changes in the material—in size, shape, stability, texture—can have great effect on the sound quality.

Another interweaving of the material and the immaterial is demonstrated by an instrument that has a special value because of a significant incident connected to it, such as an earlier treatment or a trace of use. The evidence of the incident (immaterial) is lost if the connected physical part of the instrument is lost (material).

Although the questionnaire seems simple at first glance, the answers to some questions are challenging because they require the object or its parts to be rated. These elements need to be defined when considering playability. Is it possible to value objects or parts of objects that are more or less worth preserving? How do we know that our perspective today would also be valid in the future? To avoid mistakes in this regard, an ethical principle of conservators and restorers is stated in the maxim that objects should not be valued but that all parts should be considered equally worth preserving.

The matter is further complicated by the decision of rating the material or the immaterial as more or less important. Good dialogue between all involved throughout the entire process is therefore essential if success is to be achieved. Practice in changing the role from being a defender of material preservation to a defender of immaterial preservation (in mind or in reality if wished) and vice versa, helps to maintain flexibility and objectivity in dialogue. It is a step towards the opening up of the restorer's and the educator's approach, to focus on preserving both the material and immaterial values of a musical instruments.

The sentences in the questionnaire are expressed as objectively as possible. It is accepted that the phrasing remains vulnerable and debatable. The questionnaire does not eliminate the need to discuss the relevant issues, contradictory or not. The questionnaire may be criticised as superficial and a simplification of a complex topic that should not be reduced to a framework approach. Nevertheless, the questionnaire should help to make people more aware of some of the important issues involved. When we cannot answer questions with certainty, we must do our best in trying to understand and try to arrive at the best possible answer. In a world in which communication is so much part of everyday life, it is to be hoped that the questionnaire will involve a wide range of people. The hope is that it reaches not only those working in museums, but also, on equal footing, people not used to dealing with this topic.

6. Outlook

There are experts in risk assessment in industrial contexts and experts in the professional development of questionnaires. Their standards could be consulted here to produce a revised edition of the analysis.

The attempt was made to adapt the topic to a risk analysis scheme, evaluating risk probabilities and consequences. This was possible for the material section, but the immaterial section was not easy to fit into this kind of scheme [10]. This aspect of the questionnaire may need further development.

An assessment of whether the questionnaire can generally fit all instrument types and all situations is still pending. I hope to be able

to evaluate as much feedback as possible from the field after publishing. Gradually, the most relevant values for weighing the material or the immaterial can then be incorporated into the questionnaire in a future version.

ACKNOWLEDGEMENTS: I particularly wish to thank the Ringve curators Mats Krouthén and the late Daniel Papuga who contributed considerably in finding assessable immaterial aspects of musical instruments to use for the questionnaire. There were also fruitful discussions with several colleagues at Ringve Music Museum while testing the questionnaire on instruments in the museum's collections. Friedemann Hellwig's support for the idea of the questionnaire helped to start this publication. Many thanks to Darryl Martin and Peter Juga for the time they spent polishing my English. Special thanks to Michael Latcham who helped with the final version, both linguistically and in content.

Appendix

Table 1

MATERIAL IMMATERIAL QUESTIONNAIRE	
Instrument	
Catalogue number	
	Name
Curator	
Conservator	
Specialist	
Technician	
Musician	
Others	
	Date
CHECKLIST	
QUESTIONNAIRE	
	Points
Material	
Immaterial	
Attachments	

Table 1 Cover sheet.

Table 2

MATERIAL QUESTIONNAIRE	True ↔ False			
1. An assessment of the condition of the instrument can be made without material loss.	0	1	2	3
2. Only minor reversible treatments are necessary to bring the instrument into playable condition.	0	1	2	3
3. No treatment is required that increases the risk of damage to the material of the instrument in the long term.	0	1	2	3
4. Parts that must be removed and/or replaced have no significance to the instrument now or in the future.	0	1	2	3
5. All parts are stable and free of signs of degradation.	0	1	2	3
6. The impacts and forces involved in playing the instrument are controllable at all times.	0	1	2	3
7. No parts are likely to be damaged by the impacts and forces related to playing.	0	1	2	3
8. Research is done on materials and functionality. All results are well documented.	0	1	2	3
9. Documentation of all measurements of the instrument exist in form of technical drawings, x-ray or CT scan.	0	1	2	3
SUM OF POINTS				

Table 2 Risk for loss of material.

Table 3

IMMATERIAL QUESTIONNAIRE	True ↔ False			
1. The sound of this instrument type is well known and readily available.	0	1	2	3
2. The playing is not part of an exhibition, publication or other project intended to reach the public.	0	1	2	3
3. A similar instrument / copy / replica could be used for the planned playing.	0	1	2	3
4. The playing will not be recorded.	0	1	2	3
5. There is another recording / concert / outreach project of this or a similar instrument.	0	1	2	3
6. The sound has changed through age or intervention such that the instrument no longer plays in a way that is representative.	0	1	2	3
7. No improvement of musician skills. Experiences will not be documented or taught.	0	1	2	3
8. No improvement of instrument-maker skills. Experiences are not documented or taught and do not result in producing a copy.	0	1	2	3
9. Even if not played, the object is comprehensible as a musical instrument to the viewer.	0	1	2	3
SUM OF POINTS				

Table 3 Risk for loss of the immaterial.

References

- [1] R. Barclay, *Preservation and Use of Historic Musical Instruments: Display Case or Concert Hall?* New York, NY: Earthscan, 2004.
- [2] R. Barclay et al., *Recommendations for Regulating the Access to Musical Instruments in Public Collections*. CIMCIM Publications: ICOM (International Committee of Musical Instrument Museums & Collections), 1985.
- [3] Museums and Galleries Commission, *Standards in the Museum Care of Musical Instruments*. London: Author, 1995.
- [4] ECCO (European Confederation of Conservator-Restorers' Organisations), *Professional Guidelines (II), Code of Ethics*. Brussels: Author, 2003.
- [5] Haugalandmuseene, *Vurdering av samlinger. Veiledning: Vurdering av kunst -og kulturhistoriske samlinger*. Oslo: Haugalandmuseene / Kulturrådet (Arts Council Norway), 2016.
- [6] C. Reed, "Reviewing significance 3.0. A framework for assessing museum, archive and library collections' significance, management and use," (n.p.), 2018.
- [7] W. A. Oddy and S. Carroll, "Reversibility: Does it exist?," *British Museum Occasional Papers*, vol. 135, 1999.
- [8] M. Kaliske, S. Saft, C. Jenkel, R. Lang, A. Haufe, and S. Ehrlich, *Statische Strukturuntersuchungen an historischen Tasteninstrumenten*. (n.p.): Technische Universität Dresden / Institut für Statik und Dynamik der Tragwerke / Stiftung Händel-Haus, 2012.
- [9] J. Watson, *Artifacts in Use: The Paradox of Restoration and the Conservation of Organs*. Williamsburg: OHS Press, 2010.
- [10] T. E. Pettersen, K. Axelsen, U. M. Bore, L. Riis, and T. Olav, *Veiledning: Risiko- og sårbarhetsanalyse (ROS-analyse) i norske museer*. Oslo: Kulturrådet (Arts Council Norway), 2013-2016.

Adopting a Policy of Faithful Copies of Historically Important Musical Instruments as an Alternative to Restoration

JOHN RAY (1), ANTONIO MANJÓN (1), AARON GARCÍA, PH.D. (2)

(1) Guitar-maker, Spain

(2) Universidad Internacional de Andalucía, Guitar-maker, Spain

Abstract

The authors present an argument for the production of copies in order to avoid the tendency to restore the aesthetics and/or playability of historic instruments. The primary justification for this approach is the universally accepted idea that restoration should be minimal and that by no means should the instrument be changed from what it is now. This idea is accepted in theory but not always practiced. We find it inexcusable that extensive restorations continue to be performed on important instruments given the legislation, international charters and general recommendations that argue against it. We propose integrating new interest groups in the decision-making process for a new protocol which prioritizes preventative restoration only and the creation of good copies.

1. Introduction

A restoration should be directed towards the re-establishment of the potential unity of the work of art, as long as this is possible without producing an artistic or historical forgery and without erasing any trace of the passage of time left on the work of art [1].

Any restoration must have as its basic concept the reversibility of any intervention [2].

The fundamental purpose of musical instrument collections, as in collections of any other works made by humans, is to preserve these valuable objects for future generations. Of course we also seek to learn from them and to enjoy them, but these desires are more long-reaching than immediate. Research and dissemination are also very important aspects in the case of museums and serve to a large degree to justify the existence of these collections. These pieces make up part of our cultural heritage, which is the legacy and the reference of our community.

The authors have considerable experience in restoring musical instruments and building copies of historic instruments, have reviewed the existing literature and support the many proposals to adopt a policy of making copies of as an alternative to restoring musical instruments. We believe that it should immediately be deemed illegal to perform any restoration which involves the addition or removal of any part or material. Any major intervention of this type must be justified and documented as the only means of preserving the instrument. Our idea on this subject is directly opposed to the long-standing custom of some luthiers and museum directors to restore the musical instruments in public collections. These restorations may be aimed more at the visual aesthetics or intended to make the instruments playable. The best solution, which has been proposed by many experts over the years, is to concentrate solely on preservation, preventing further deterioration and maintaining these objects for future generations. The alternative to restoration that still allows us to discover for others the workings of these instruments, even to know what they sounded like (within limits), is the building of exact copies which can be displayed, handled and played publicly, giving voice to the music of their day. This approach preserves the information that is potentially available to us but is also useful if we wish to recover the spirit of instruments that are damaged beyond repair. There are examples of instruments that only exist in graphical representation, and in these cases, we would make a “reconstruction”, but some of the same experts might be involved. We believe that anything less than the whole-hearted adoption of this policy is in many cases illegal and always irresponsible with regard to the preservation of our cultural heritage.

In the following sections we will first establish some terminology and discuss the work that has already been done by both governments and experts in the field. The main body of the text will be devoted to justifying this approach, and in the conclusion, we will make a concrete proposal for adopting the policy of making copies of every historic instrument that we desire to play or in some cases just display.

2. Terms

We often observe that instrument-makers offer replicas, reproductions or copies, or use terms like “inspired by”, “after”, “in the style of”. These are often marketing terms and are not relevant to our work. For our purposes here we will use the following definitions laid down by Elste [3] for objects which are motivated or influenced by “original instruments”.

1. The reproduction. This category covers those instruments at which the instrument maker has knowingly departed from details of the historical object. In a way, it is as modern and at the same time as false as reproduction furniture.
2. The reconstruction. It is always the more or less speculative result of organological research and covers the re-making of the original state of a historical object as well as the construction of all those instruments, historical copies of which are no longer fully or not at all available for measurements and study.
3. The true copy or exact copy. This term should be used only when the instrument maker has tried to re-create a historical object in every detail. It is a legitimate goal but it is always based on dated knowledge that is quickly superseded by further research.
4. The counterfeit. For this, the instrument maker tries in his new object to imitate the appearance of an old one, possibly by using historical parts. Usually, counterfeits are not true copies, because most historical objects were, after all individual objects, and thus there is no financial interest in faking a specific object while the original is known to exist somewhere else. Sometimes specific features of instruments such as violin labels are counterfeits.

We discourage use of the terms “facsimile”, which should be reserved for documents or graphics, and “replica”, which refers to objects made by the author who made the original. Regardless of the words we use, there will always be some level of inaccuracy and speculation, be it through lack of information or the irresistible desire to introduce

what we think of as improvements. As our knowledge about musical instruments and examination methods increases, so will our ability to make ever more accurate copies.

3. Legislation and International Agreements

We cannot discuss conservation nor propose any protocol without referring to what has already been written. Many of the examples here were developed with built heritage or paintings in mind but are easily applied to musical instruments. Currently, in many countries, it is not permitted to restore objects in public collections except for processes of consolidation, conservation and preservation. However, the general trend to date has been to do the opposite, using very out-of-date criteria. Often the intention is to exhibit certain important pieces with the hope of attracting the public and of course the very necessary patrons of the arts and benefactors. Sometimes a public entity wishes to see the result of its investment in a museum, and an instrument must be exhibited or played in order to fulfil this political demand. This is of course unacceptable.

We will not discuss European legislation exhaustively but rather point out a few examples that illustrate our point. We look to conservation law of works of art in general, which is easily applicable to musical instruments. In Spain, the law of reference is the Historical Heritage law, parts of which are indicated here:

In the case of built heritage, the interventions will be limited to conservation, consolidation and rehabilitation and will avoid attempts at reconstruction except when using original parts of the building and authenticity can be proven. If the stability or maintenance of the building requires the addition of materials or parts these should be recognizable as such in order to avoid confusion with original materials or parts (artículo 39.2, Título IV).

Any restorations will respect the interventions or additions from past epochs. The elimination of any of these will only be authorized in exceptional cases and only if the modification to be reversed presents a clear degradation of the object and its elimination is necessary in order to allow a better historical interpretation of it. Any eliminated parts must be thoroughly documented (artículo 39.3, Título IV) [4].

The recent history of restoration has been marked by the directives stipulated by a number of international agreements that have defined actions permissible in this field. The following documents should be considered: the Athens Charter for the Restoration of Historic Monuments (1931), the Venice Charter (1964), the Restoration Charter (1972), La Carta di Restauro (1987), the Document of Pavia (1997), and the Krakow Charter (2000). All of the above stress the ideas

of respect for the history and art, and recovering the understanding of cultural heritage, while safeguarding all of the material and keeping the documentary values intact. Any additions or modifications from other periods should be preserved as they are a testament of the human endeavour. Some examples from these agreements are as follows:

La Carta di Restauro (1987): Conservation measures do not only refer to the safeguarding of a singular object and a set of objects considered to be significant but also to the environmental conditions... The actions applied directly to the object in order to detain, where possible, damage and degradation should be interventions that respect the physical characteristics of the object as it has come to be through its natural and original materials, retaining its readability [5].

The Krakow Charter (2000): Maintenance and restoration are part of a fundamental conservation process of our heritage. These actions must be organized with a systematic investigation: inspection, monitorization, follow-up, and testing. Any possible deterioration must be predicted and reported beforehand and preventative measures must be taken [6].

Another important document is published by the Spanish Ministry of Culture:

Previous to any intervention, an interdisciplinary investigation will be carried out and the results will be collected in a report... Following this a protocol of action must be developed...

The principle of minimum intervention is of transcendental importance. Any manipulation of the object incurs risk; therefore only what is strictly necessary should be done.

Consolidation will be performed with products and methods which will not alter the physical-chemical properties of the materials, nor the aesthetics of the object and will be localized only where necessary.

Any cleaning process, whether mechanical or chemical, should never alter the materials, nor its structure, nor the primitive aspect of the work of art.

Reintegration will only be used as a last resort when it is necessary for the stability of the object.

Reintegrations must be justified by recovery of correct interpretation of the work.

Strategies for the prevention of deterioration should be fundamental to the conservation of pieces of Cultural Heritage.

The systematic elimination of historical additions must be avoided. Elimination which is unjustified or undocumented will cause an irreversible loss of information [7].

The truth is that if we could uphold the standing legislation and the many charters that have been written, we would be well on our

way to solving the problem of inappropriate restorations. Obviously a great deal of energy, time and thought have already been invested, so why are these directives not followed? Perhaps we should start lodging formal complaints against those who perform restorations that do not fully comply with current legislation.

4. Excellent Copies

As our knowledge about musical instruments grows, as we learn more about historical techniques and as technology advances, the possibility of making a perfect copy improves steadily. As copies become more accurate, the wisdom of this approach becomes indisputable.

Any copy that might be proposed requires exhaustive documentation and hence a meticulous examination of the instrument. The resulting quality will depend on the information obtained before starting the work. Describing the process of meticulously examining an instrument and making an exact copy falls outside the scope of this article, but we will point out a few things to keep in mind. For methodologies, please see Ray, *et al.* [8] and Fontana [9]. The examination should be done by a luthier who intends to build an exact copy ensuring that every aspect is taken into account and that the examination uses the structure of the techniques that the original builder might have used. The museum or owner should insist on retaining a copy of all documentation produced so that this examination need not be repeated. The basic elements of this investigation [8], visual examination, hand tools and data sheets together with the judicious use of appropriate technology with different study techniques and non-invasive data-gathering will allow us to obtain precise and complete information to advance in the study of musical instruments.

As the technology becomes more accessible, museums should be able to finance a modelling study of the instrument to aid in the examination. Tomographic analysis is very helpful for revealing internal structure, thicknesses and volumes. Dendrochronological analysis is interesting if importance is to be given to the age of the wood used for the copy. We can also use vibration analysis to test the similarities between the original and the copy [10].

Of course close collaboration with musicians will also be necessary to determine, compare and develop the sound of the originals and the copies. Players of period instruments are also the best suited to judging the playability of the copy, a key element if our proposal is to be successful. This work with the musicians will also help to convince musicians of the benefits of this approach as they will be able to make music with the newly completed copies of these original instruments.

Different methods of scientific observation and study will help us to be able to:

- discover the nature of the material (wood), durability and hidden defects, and to identify structural defects,
- perform shape analysis using interferometry with visible, ultra-violet or infrared light, moiré, holographics or laser,
- discover the anatomical and physiological aspects as well as the history of the wood with dendrological and dendrochronological studies and comparative studies using databases,
- take photographs and videos of both the exterior and interior to record dimensions and density of the materials,
- obtain realistic simulations with graphic design tools and radiological, photogrammetric, endoscopic or tomographic studies,
- discover possible sources of biological degradation through physical-chemical analysis,
- describe acoustic responses, like resonance levels and harmonic spectra using physical-acoustic, spectral and modal analysis.
- thoroughly study the maker's body of work or as many instruments as possible by the maker, with particular attention to the techniques and methods in order to better understand the instrument as a whole.

5. Dangers of Restoration

Some advocates of restoration to playability report the modification of instruments for other purposes, e.g., Torres 11 strings modified for 6 strings, a harpsichord modified to be a speaker cabinet, and many other examples as support for their theory; if not for these modifications, the instruments would not have been useful and so would never have survived to our day. This is true, as is the fact that the extensive maintenance and modifications of the Baroque violins made them playable and useful, leading them to be preserved. However, it is time that we recognized that we no longer live in the eighteenth century, and that we have the means to both preserve our heritage and to play the music that represents it, but not on our heritage instruments. We have no legal nor moral right to slowly destroy our heritage.

Any act of restoration must not eliminate original elements from the instrument nor cause alterations to the form, materials or mechanical characteristics, nor should it modify its original aspect, its sonic characteristics (acoustic potential, tonal qualities, wave modulation) nor its typology nor use [5].

Indeed, we have all the tools necessary to describe the essential characteristics of the object using respectful and conservative non-invasive methods. The decision we must now make is, in light of this information, what is the correct course of conduct with respect to the

musical instrument. Keeping in mind that the instrument was originally designed to play the music of its period, we choose to reject the restoration to playability, but rather take preventive measures to avoid further damage and make a copy of the instrument.

We can contrast this with cases in which an attempt is made, through major restoration, to re-convert the instrument to its supposed original state when it was first made. This is always misguided and is certainly a historical forgery because we can never recover the original state of the wood, glue and varnish. Over time, all of these elements have undergone changes that affect every aspect of the instrument. Furthermore, the deliberate modifications that the instrument has been subjected to must also form a part of what it is today. These changes should remain evident in the object that we have preserved precisely in order to record the culture and its effects so that we might learn from it.

One thing that comes up repeatedly in this field is that the criteria for restoration changes as aesthetic sensibilities change, so that a perfectly executed restoration in the Italian renaissance is today deemed to be woefully inappropriate. Limiting ourselves to making a copy allows for new criteria to come to the fore at any time, and for the original to survive until that time unaltered, to then be subjected to whatever intervention believed to be correct at that time. If we perform a complete restoration now with today's criteria, no matter how reversible we believe it to be, any subsequent change involves risks and degradation. This idea is already well-developed in Barclay [11].

6. The Importance of the Tonal Entity

In taking a stand on this dilemma, we should analyse the sonic entity of the object. From a musical point of view, the desire to discover the ancient instrument is an interest in discovering the sound that it produced at the time of its construction, to place oneself in that period and to appreciate its music, to hear the musical timbre of a bygone time.

This desire comes up against the natural difficulties of wear and deformation which all works of art suffer through the passage of time, environmental conditions and human contact. In the case of a musical instrument, there are also the mechanical forces that are inherent in its sound-producing nature. The resulting deformation and fatigue of the material change the original sound of the instrument in the same way that in a restoration process, the addition of new elements or the elimination of original elements will change the sound.

Restorations performed with sonic purposes [12] seek to bring the sound of the instrument closer to that of a consolidated model which has been well-preserved. This is usually the measuring stick which determines whether the restoration process has been a success. While

this goal might be achieved to some degree, the sound of the restored instrument will never be like that of the original.

Musical instruments which have slight damage lose their status as a faithful sonic document, unlike the deterioration in the points of union in a wooden panel of a painting which does not impede the understanding of the work as a whole [2].

No matter the state of conservation of a given instrument, any intervention will always move it further away from its potential unity in one or various of its aspects: historical, aesthetic or sonic. Consequently, we are convinced that the only valid path is to choose the option which results in the least change. In our opinion a two-pronged approach of preventive measures and the construction of an exact copy is the path which best fills these requirements.

Prioritizing preventive restoration [1] allows us to perform the tasks that are imperative to the survival of the instrument, and involves cautionary measures that may sometimes be significant, but can go no further than avoiding the further deterioration of the instrument. We cannot allow the instrument to reach a point at which it cannot be recovered. Again, the idea is to conserve the original in the best possible state and assure its future.

In making the copy of the musical instrument, we choose the physical characteristics of the material to be as close as possible to the original, use the exact dimensions, copy the constructive techniques, replicate the acoustic response—all thanks to the data-gathering and scientific analysis performed on the original. Without a doubt, this will bring us closer to the sound of the instrument when first completed than what we could obtain with a restoration of the original. After all, the original was also once a recently finished work, made with the fresh glue, varnish and wood available at the time.

The possible historic or aesthetic forgery [1] that we might create when we make the copy is completely forgiven thanks to the continued availability of the unaltered original in which these historic and aesthetic manifestations remain. In avoiding as much as possible any interventions on the original we are strictly following the basic standards of restoration by respecting the historical and aesthetic status, making no changes to the sonic qualities and avoiding the problem of reversibility.

7. Further Considerations

The ethical questions raised in restorations, but perhaps even more so by this approach, are numerous, but we will address only a few of them here. Foremost in everyone's mind these days are the CITES restrictions on

many materials that have traditionally been used in instrument-making: tropical woods, ivory, shell, and other animal parts. The authenticity of the copies that we propose is very important, but as Koster [13] states the decorative elements need not be reproduced if our intention is to make instruments that can be played, especially if the same museum will house both copy and original. Every effort should be made therefore to substitute endangered materials with others of similar characteristics. Non-tropical woods are providing excellent results in instrument-making, and synthetic materials can be made to look like almost any natural one.

As for environmental concerns, once again we can take advantage of the work done in the restoration of furniture and the like for some ideas on this subject. The regional government of Navarra in Spain, for example, has published manuals on good environmental practices [14] for this collective, covering the use of insecticides, glues and varnishes. They seek to safeguard the environment from the negative effects of these products, not only at the level of material sources and maintenance of tools and machines, but also through correct management of the waste produced.

8. Financial Concerns

Although we believe that it is entirely the province of the museums and their executives, we would like to make a few observations with respect to the financial implications that this change in attitude towards the conservation of our musical heritage might have. Given the limited resources available to museums, one might worry that financing such copies could be prohibitive. However, it should be noted that active restorations can involve similar costs, and sometimes several restorations are needed over time. To support our alternative to restorations, we propose the following methods of financing:

- The publication and sales of the study of the instrument with detailed blueprints will be of great interest to makers, musicians, musicologists and amateurs.
- Concerts can be organised using the copies (singly or in ensemble).
- Copies could be rented out to professional musicians for specific concerts thereby generating additional income or in the case of loans increased visibility.
- Museums can count on more visits because knowledge of the original instrument will be much more complete and available as well as the fact that the copy will be much closer visually to the visitor and its music can be heard at least on some occasions.
- Audio-visual material documenting the process of construction of the copies are another source of income and publicity.
- The sponsorship of large companies (electrical, telephone, large

banks) or local businesses involved in culture is very important to museums already. These businesses will certainly be more satisfied to see something concrete which their money has provided (the copy).

- Although the logical channel for the acquisition of a copy of a museum instrument is through the instrument-maker who has made a copy for the instrument, there is no reason why the museum could not order two copies at a discount and auction off one of them as a fund-raising event.
- Some universities or businesses in the cultural sector might be willing to offer internships to handle some of the work (field studies, X-rays, TAC, etc.)
- Crowdfunding is a possibility that should not be overlooked in this day and age.

We believe that the growing interest in playing period music on period instruments will encourage musicians with a special interest in performing on these copies of the best instruments in museums. The collaboration of the instrument-maker with the museum will offer many opportunities for increased visibility of the instrument in question as well as the entire collection.

These aspects are something that can certainly be discussed at much greater length in other works. Our intention here is simply to offer our impression that this proposal is not significantly more expensive for the museum, nor should we be afraid of exploring new sources of financing.

9. Disclaimer

The authors, especially thanks to our experience making copies and reproductions, are aware that we have yet to learn what it is that makes each instrument-maker unique and how to replicate the effect of that. Furthermore, working with a material as variable as wood means that the same result as in the original is harder to achieve. Gathering the knowledge and controlling the technology to make a perfect copy is a goal that we continue to pursue, but in the meantime, we firmly believe that making a copy which is as exact as possible is much better than making changes in the original instrument.

10. Conclusions

This idea has been advanced by individuals, museums and in publications which have sought to represent or establish the opinion of those working in the field of conservation [15, 16]. Why, then, has this approach not been accepted, and why are we still carrying out extensive restorations of historically important instruments, reversing changes that have been made over the years and trying to play music on original instruments? It seems to us that the main stumbling block is the differing priorities of the interest groups involved in this issue.

The museums and their staff, and in some cases legislators, are charged with preserving culture and the objects that represent it for future generations. Part of this mandate is education and rational access to its collections. In most cases, this results in policies that favour only minimal interventions designed to halt the deterioration of the pieces. Museums are interested in conservation, historical accuracy, a low profile and guarding their own collections knowing that travel and use are detrimental.

At the other extreme is the musical instrument dealer. This figure acquires a piece and spares no effort nor expense to restore it to “mint” condition which includes shiny varnish, replacing any deteriorated parts or any parts deemed to be aesthetically incorrect. Sanding out defects and using reinforcements to allow playability are the main crimes, although the greatest damage done by these dealers is perhaps the campaign of misinformation to his clients. Guitar collectors are told that the nicer-looking the instrument is the higher the price should be, whereas the value of the instrument should be its authenticity and the story it tells of construction, use, restorations and the passage of time. These people with their great influence on consumers have to a large degree convinced those with money that it is playability and perfection that represent value. It goes without saying that the collectors who buy into this falsehood become as much a problem as the dealers themselves. These groups, along with musicians, are often obsessed with what they like to call authenticity, which to them means that it fits with their preconceptions about what the instrument should be including the ideal of “completely original”.

Musicians are understandably interested first and foremost in being able to play and hear original instruments. Our job will be to convince them that deterioration due to playing would be a loss to all of us and to future generations. We need their input in this endeavour because they are the ones who will allow us to hear how these instruments sound and to test the new ones. The playing techniques and the repertoire of these instruments is very important to their sound, and it is often the experienced players who have carried out this research and can play them in a historically correct manner.

Luthiers are the ones who will research methods of construction, measure and photograph the instruments, draw blueprints and of course

build the copies that are the objective of this proposal. In addition to the desire to learn from historical instruments and a passion for their craft, one might also find a desire to produce copies for museums as a way to complete an insufficient income and to increase prestige.

However, all of these groups have something to contribute: if it were not for collectors, so many more instruments might have disappeared or been allowed to fall into ruin. Of course the power of the dealers to convince and impress is also a power to awaken the music-lover to the wonders of historical instruments, research and period music. Obviously, musicians are central to the struggle to teach the general public about the importance of everything we do; without music, instruments are not of much interest to the general public.

Perhaps any attempt to implement the philosophy of the exact copy as an alternative to restoration should be based on a consensual agreement among representatives of museums, players of early instruments, luthiers, private collectors and dealers. The inclusion of collectors and dealers has historically been avoided because of their perceived disparity in priorities compared with the rest of the groups cited. However, it is precisely this point of view that is necessary in order to adopt a policy that will actually be implemented, as they will continue to have a huge influence on the other groups through their management of their collections and the decisions they make. It also goes without saying that these groups have more money to spend on purchases than any of the other groups. We propose a task force representing the different groups: three major music museums in Europe, three important collectors of musical instruments, three instrument-makers specializing in copies, three musicians specialized in early music and three large dealers in musical instruments. We would like to point out that the those involved with violins will not find this approach particularly convincing, as those who work with bowed-instruments seem to be firmly married to the concept of playability and the value that it gives the historic instrument.

References

- [1] C. Brandi, *Teoría del Restauro*. Turin: Einaudi, 1991.
- [2] P. P. Donati, "Técnicas de conservación de órganos antiguos," in L. Masetti Bitelli (Coord.), *Restauración de instrumentos y materiales: ciencia, música, etnografía*. San Sebastián: Nerea, 2004, pp. 139-146.
- [3] M. Elste, "Reflections on the 'authenticity' of musical instruments," in *Copies of Historical Musical Instruments*. CIMCIM Publications, 1994, pp. 3-7.
- [4] Ley 16/1985: *Patrimonio Histórico Español Boletín Oficial del Estado* (Spanish Govt. Bulletin), 155, pp. 20342-20352.
- [5] Consiglio Nazionale delle Ricerche. *La Carte di Restauro* (Charter for the Conservation and Restoration of Cultural and Art Objects) [Online]. Available: <http://sangem.s3.amazonaws.com/wp-content/uploads/2015/11/Italian-Restoration-Chart-of-1987-MC.pdf>. Accessed on April 10, 2018.
- [6] Krakow 2000: International Conference on Conservation, The Charter of Krakow. [Online]. Available: <http://smarterheritage.com/wp-content/uploads/2015/03/KRAKOV-CHARTER-2000.pdf>. Accessed April 10, 2018.
- [7] Ministerio de Cultura, *Decálogo de la restauración. Criterios de intervención en Bienes Muebles* (Madrid, 2007). [Online]. Available: <http://aparejadoresacc.com/wp-content/uploads/Dec%C3%A1logo-del-Restaurador.pdf>. Accessed on April 10, 2018.
- [8] J. Ray, A. Manjón, and A. García, "A review of basic procedures for an organological examination of plucked-string instruments," *Journal of Cultural Heritage*, vol. 27S, pp. S17-S25, 2017.
- [9] E. Fontana, "Measure for measurement," in *Copies of Historical Musical Instruments*. CIMCIM Publications, 1994, pp.13-15.
- [10] J.-L. Le Carrou, S. Le Conte, and J. Dugot, "18th and 19th French harp classification using vibration analysis," *Journal of Cultural Heritage*, vol. 27S, pp. S112-S119, 2017.
- [11] R. Barclay, *The Care of Historic Musical Instruments*. Edinburgh: Museums and Galleries Commission / Canadian Conservation Institute / CIMCIM, 1997.
- [12] M. Tiella, "El estudio histórico y tecnológico de los instrumentos musicales: aplicación de tecnologías avanzadas en la restauración," in L. Masetti Bitelli (Coord.), *Restauración de instrumentos y materiales: ciencia, música, etnografía*. San Sebastián: Nerea, 2004, pp. 107-139.
- [13] J. Koster, "The 'exact copy' as a legitimate goal," in *Copies of Historical Musical Instruments*. CIMCIM Publications, 1994, pp.7-13.
- [14] Govt. of Navarra, *Restauración en Madera*, 2001. [Online]. Available: http://www.crana.org/themed/crana/files/docs/251/117/restauracion_madera.pdf. Accessed April 10, 2018.
- [15] CIMCIM, *Recommendations for Regulating the Access to Instruments in Public Collections*, 1985. [Online] Available: http://network.icom.museum/fileadmin/user_upload/minisites/cimcim/pdf/Recommendations_for_regulating_the_access_to_musical_instruments_in_public_collections_AE.pdf. Accessed April 10, 2018.
- [16] CIMCIM. *Recommendations for the Conservation of Musical Instruments: An Annotated Bibliography*, 1993. [Online]. Available: <http://www.co-bw.com/Maintenance%20Files/Recommendations%20for%20the%20conservations%20of%20musical%20instruments.htm>. Accessed April 10, 2018.

Methods of Dendrochronology for Musical Instruments

MAURO BERNABEI (1), KATARINA ČUFAR (2)

(1) CNR-IVALSA, Trees and Timber Institute, National Research Council, Trento, Italy

(2) Biotechnical Faculty, Department of Wood Science and Technology, University of Ljubljana, Slovenia

Abstract

Dendrochronology is an important technique for studying musical instruments. It can be applied in stringed instruments in an absolutely non-invasive way for analysing tree-rings on the instrument's belly. If correctly done, it allows: 1) dating of the wood through identification of the *terminus post quem*, 2) hypotheses on the origin of the wood supply, 3) validation of the attribution of an instrument to a particular violin-maker or school, 4) verification of the instrument's technical characteristics, such as the arrangement of the elements of the resonance board, the tree-ring mean values and relative standard deviations, the direction of growth, the presence of wood defects, such as reaction wood, and grain deviations. The advantage of dendrochronology lies in its scientific rigour and its independence from stylistic or literary considerations. We present the general principles of dendrochronology applied to musical instruments, as well as sampling strategies, statistics of cross-matching, dendroprovenancing and interpretation of the results.

1. Introduction

Dendrochronology is the science that studies tree-rings in relation to time. It is based on the principle that tree-ring growth is largely influenced by the environment in which the tree grows, especially climate and weather. If the conditions influencing the formation of growth rings are similar over a large area, the growth of numerous trees of the same species is well correlated [1]. This means that the time sequence of tree-ring widths, tree-ring series, is similar for all the trees of the same species in the same area.

Dating a wooden object is based on measurements of the widths of consecutive tree-rings. From these, tree-ring series are constructed, which are then compared, cross-dated, using reference (master) chronologies constructed for a particular tree species and geographic area. The reference chronologies must be based on tree-ring widths of a sufficient number of trees and should be long enough to span the period of interest.

Dendrochronology has shown great potential in determining the age of wood in various objects that are part of our cultural heritage [2, 3]. It has been successfully applied in the field of musical instruments, with the earliest dendrochronological investigations dating back to the late 1950s [4]. Since then, many important applications of this method have been used [5], mainly on stringed instruments, such as violins, violas and cellos made by well-known violin-makers [6, 7 and many others].

The tree species frequently used for the construction of musical instruments include Norway spruce (*Picea abies* Karst.), maple (mainly *Acer platanoides* L. and *A. pseudoplatanus* L.), ebony (*Diospyros* spp.), cherry (*Prunus* spp.), willow (*Salix* spp.) and beech (*Fagus sylvatica* L.). Of these, only spruce and beech are suitable for dendrochronological analysis. Spruce is the most frequently employed for dendrochronological dating of musical instruments. In string instruments, spruce is usually used to construct the soundboard, which is the key element that strongly characterizes the instrument, from both acoustic and aesthetic points of view [8, 9]. Consequently, analysing the soundboard means characterising the instrument in a decisive way.

Wood for the construction of a soundboard must meet specific quality requirements: narrow, uniformly wide rings, and a general absence of knots, reaction wood and other defects [10]. These characteristics of the wood influence the similarity between the tree-ring series of different trees. When dating instruments, therefore, we often obtain higher and more significant statistical values than in other applications of dendrochronology, such as in the case of dating building constructions [11].

The aim of this chapter is to review the methods and possible applications of dendrochronology in the field of musical instruments. We present and discuss the main sampling techniques, statistical tests

of agreement, the meaning and interpretation of dating, the application of dendroprovenancing, the term Δt and the use of dendrochronology to study technical constructional characteristics of instruments.

2. Sampling and Tree-Ring Measurement

The main objective of dendrochronological sampling is to measure the widths of as many tree-rings as possible in a defined part of an instrument, mainly the belly.

Traditionally, the process of construction of the soundboard of a stringed instrument starts with a quarter sawn piece of spruce wood. This element is subsequently cut into two parts. In the next step, the edges facing the bark are longitudinally joined so that they form the central part of the resonance board [Fig.1].

Fig.1

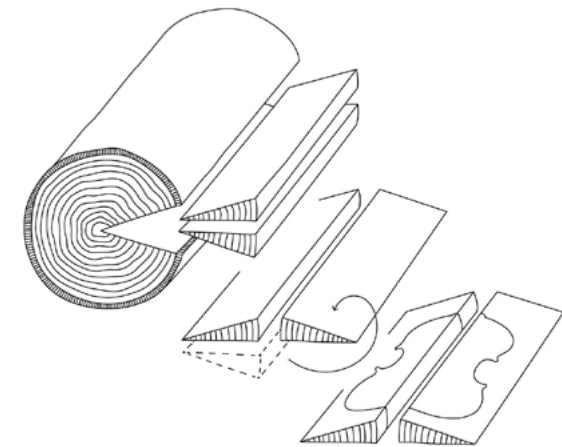

The soundboard thus consists of two mirror elements, with the part of the wood most recently formed (in the tree) located in the middle of the soundboard (Fig.1 and Fig.2). The soundboard may occasionally also consist of a single element, two elements oriented in a different way, or more than two elements, as sometimes observed especially in larger instruments (e.g., viola and cello). For tree-ring width measurements, the areas on the soundboard where the growth layers (tree-rings) in the wood can clearly be seen must be identified. The selection of the soundboard area useful for measurement also depends on the number and arrangement of the parts that compose the board, and on the transparency of the varnish layer. It is generally advisable to perform at least two tree-ring

Fig.1

Schematic representation of the construction of a violin belly following standard procedure.

width measurements for each portion of the soundboard, possibly at different locations. Parts where various defects may occur can thus be avoided. After the measurements have been taken, the tree-ring series can be immediately compared and, if necessary, the measurements repeated.

Fig.2

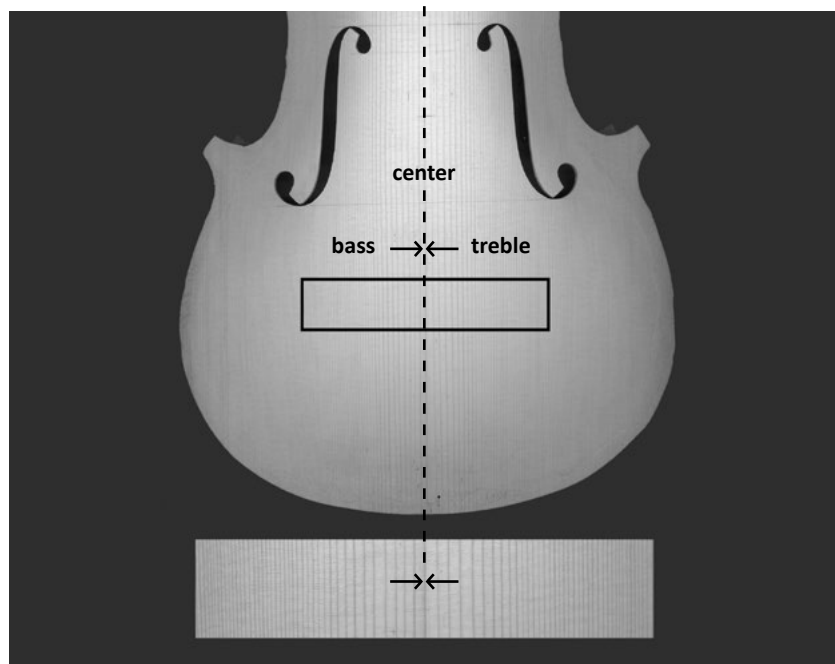

Tree-ring width measurements on musical instruments should be performed in an absolutely non-invasive way. Various tools are available for this purpose.

- Traditional dendrochronograph: this device consists of a stereomicroscope associated with a micrometric movement mechanism. The movement of the sample, or of the microscope, depending on the system, is expressed in mm/100 and is automatically recorded on a computer. This system is believed to be the most accurate and reliable thanks to the high-resolution of the image of the wood structure obtained by the stereomicroscope, and the possibility of zooming the magnification (as a rule between 2x and 100x), as well as changing the angle of the illumination to obtain the best

Fig.2 Violin belly made of two radial boards. The part inside the black rectangle is shown below; arrows show the central part, where the two boards are glued together. Tree-rings in the middle originate from the outer part of the tree and are therefore crucial for dating the instrument.

possible image. On the other hand, a measuring device of this type is bulky, and the musical instrument must be moved during the measurement.

- Portable dendrochronograph: a controlled movement system connected with a digital camera [Fig.3]. This device allows a properly calibrated tree-ring width series to be obtained immediately and *in situ*. The great advantage of the procedure is the possibility of immediately verifying the correctness of the measurement and repeating it in case of errors or inconsistencies. Moreover, thanks to the focal distance, the depth of field and the use of telecentric lenses, it is possible to perform the measurements without removing the strings from the musical instrument and without taking the instrument from the showcase if it is, for instance, exhibited in a museum.

Fig.3



- Photographic sampling: the advantage of taking photos is simplicity, but there are some disadvantages, mainly related to calibration of the measurements, parallax errors and image distortions induced by lenses. Because of these drawbacks, caution is needed with this method, especially when constructing reference tree-ring series.

Fig.3 Portable dendrochronograph being used to measure tree-ring widths on an Amati cello in the “Luigi Cherubini” Conservatory Collection, Accademia Museum, Florence. The measurements of the ring widths are made without removing the instrument from the showcase.

Image acquisition is particularly helpful when the musical instrument cannot be brought to a laboratory. In addition to cameras with telecentric lenses, various scanners are also used to capture images [12]. Furthermore, different approaches with X-ray computed tomography (CT) have also been recently developed to provide high-resolution images for tree-ring measurement [13]. It should be noted that tree-ring measurement on images can be strongly facilitated by using systems for automatic recognition of tree rings, such as CooRecorder [14].

Nevertheless, each of the methods has specific limitations and peculiarities. In general, many dendrochronological laboratories still rely on direct measurements on the instrument with the help of a fixed or portable dendrochronograph and, as a rule, high-resolution photographic images are taken to be used for verification of the measurements.

3. Dendrochronological Dating

After the tree-ring width is measured, a tree-ring series (time series of tree-ring widths plotted as a graph) is established and a cross-dating procedure is applied to define the calendar years in which the individual tree-rings were formed. Cross-dating is basically a comparison of an as-yet-undated tree-ring series (from the object) with a dated reference chronology. Such a comparison can be done visually by comparing the graphs and/or by calculating statistical parameters developed for dating purposes [12].

Statistical tests are generally crucial for dendrochronological dating, and they help to confirm whether the dating is correct. However, if used uncritically, errors can also be obtained, as described by Sander and Levanič [15]:

- a wrong date may be obtained even if the statistical values are high and significant (type I error);
- true dating may not be recognized due to low statistical values (type II error).

To avoid such errors, each tree-ring series must be subjected to visual and statistical comparison with a number of reference chronologies. The dating can be considered correct only when the same year is confirmed by multiple reference chronologies.

The tests and statistical parameters used in dendrochronology are:

- t_{BP} : Student's t-test, adapted by Baillie and Pilcher (1973) to time series analyses. In a series of over 100 rings with a t_{BP} of 3.5, the probability of having a random dating is one in a thousand [16].
- Gleichläufigkeit (or Glk): when comparing two tree-ring series in

a given time interval, Glk is the percentage of agreement between the sign of growth from one year to another [17].

- Statistical significance of Glk: it may be 95.0%, 99.0% or 99.9%.
- Overlap: the time interval common to two tree-ring series to which the tests refer, expressed in number of rings. Dendrochronology is a science based on statistical correlations, whereby a higher number of data compared (longer tree-ring series), leads to greater reliability of the results. Although it is difficult to establish thresholds [18], generally a series having more than 70 rings gives satisfactory results, and the number of tree-rings should not be less than 40.

As a rule, the dating of a tree-ring series can be considered reliable when t_{BP} is higher than 4, with correspondingly high values of Glk and the level of significance obtained with multiple reference chronologies. Statistics must always be complemented by visual comparison: the human eye is able to grasp relationships between chronologies in an immediate and concise manner, while using only statistical analysis can sometimes lead to error [15].

Terminus Post Quem

The date (i.e., year of tree-ring formation) obtained with the help of dendrochronology, defined as the *terminus post quem* (the limit after which), refers to the last (most recently formed) visible tree-ring on the instrument's soundboard. This date indicates the year in which the most recently formed growth ring on the soundboard was produced by the tree when it was still alive, i.e., before tree felling and subsequent operations such as wood hauling, transport, seasoning and processing.

The *terminus post quem* is an objective and independent chronological reference, on which subsequent technical or historical analyses can be based. It should be noted that this term almost never coincides with the year of manufacture of the instrument, but it is a chronological limit (as suggested by the name) before which the soundboard could not have been made.

5. Δt Interval

The term Δt indicates the interval (in number of years) between the dendrochronological dating and the date of instrument manufacture (which can be inferred from the label or from other historical sources). This interval includes the time from tree felling to use of the wood and includes the number of years of wood drying, plus a number of years corresponding to the number of annual-rings below the bark eliminated

due to wood processing. Making the soundboard involves trimming excess material, including removal of the wood located immediately under the bark, to obtain regular surfaces for gluing and joining. However, most modern instrument-makers agree that, usually, only a thin layer of wood close to the bark should be removed when a soundboard is produced; at the same time, they prefer to avoid the wood in the innermost part of the trunk [11, 12]. The Δt interval therefore allows an estimation of the time of wood drying, which is of crucial importance, especially when studying historical construction techniques [Fig.4]. Different dating of the bass and the treble side is attributed to different number of the outermost rings removed during the production of the resonance board [12].

Fig.4



6. Dendroprovenance

The principle of dendroprovenancing is based on the assumption that the similarity between two tree-ring series of the same or nearby sites is higher than between those of distant areas. When comparing a dated

Fig.4

Two violins in the final stage of manufacture, produced by Blaž Demšar - Atelier Demšar, with bellies made of two spruce boards. The end dates of the violins (i.e., the most recent dates of the two radial boards) are 1988 and 2005 and should be considered to be the *termini post quem*. According to data from the producer, the violins were made in 2014 (violin 276) and 2015 (violin 283) from logs bought in early 2011, from the trees having been felled in winter 2010/2011, which produced the last ring in 2010. The Δt intervals are therefore 26 and 9 years, respectively.

time-series of unknown provenance with a suitable number of reference chronologies from various sites, the correlation value will be highest with that chronology whose tree-ring growth was influenced by environmental factors most similar to the single time-series. In theory, the higher correlation value between dendrochronological curves means closer distance between the sites where the trees grew.

Evidently, the ecological conditions under which trees grow are of great importance. These may, however, vary considerably even in neighbouring sites. Altitude, for example, is an important factor that influences the correlation values between tree-ring series considerably. However, with an adequate number of geographically and spatially well-distributed reference chronologies that represent many different ecological criteria, the highest correlation values are supposed to indicate the provenance of the wood.

These and other considerations make the dendroprovenancing analysis very complex. Anyway, the dendrochronological indication of the wood provenance of stringed instruments is positively influenced by the high quality of the wood used for their construction; it is usually without defects, has narrow, regular tree rings and generally originates from high-altitude locations. These characteristics increase the similarities between individual time-series and, hence, their correlation values, which are usually higher than those found in other applications of dendrochronology [19].

Numerous reference chronologies have been constructed for different spruce sites. They also include localities that were traditionally suited for the acquisition of resonance wood. Some such chronologies are available on the International Tree Ring Data Bank website (ITRDB, <http://www.ncdc.noaa.gov/paleo/treering.html>). Unfortunately, they mainly cover recent periods and therefore cannot be used for dating historical instruments.

7. Instrument Attribution and Labels

The existence of different violin-making schools, the practice of imitating the technique of the great masters and, sometimes, the aim of fabricating copies with the intention of selling them as originals, are aspects that can make the correct attribution of an instrument difficult. In such cases, dendrochronology can also help [11, 20]. It is well known that when a violin-maker finds wood particularly suitable for the construction of the soundboard, he/she continues to produce boards from the same area of origin. Since the instruments are small, a number of soundboards are produced, even from the same trunk. This explains why the cross-dating of tree-ring series between instruments from the same workshop often results in surprisingly high agreement

[Fig. 5]. The instruments of Stradivarius are the most representative example of this. Although the wood supply area of Stradivarius is still not precisely known, most of his soundboards show very strong dendrochronological agreement, which in some cases confirms that they originated from the same trunk [4].

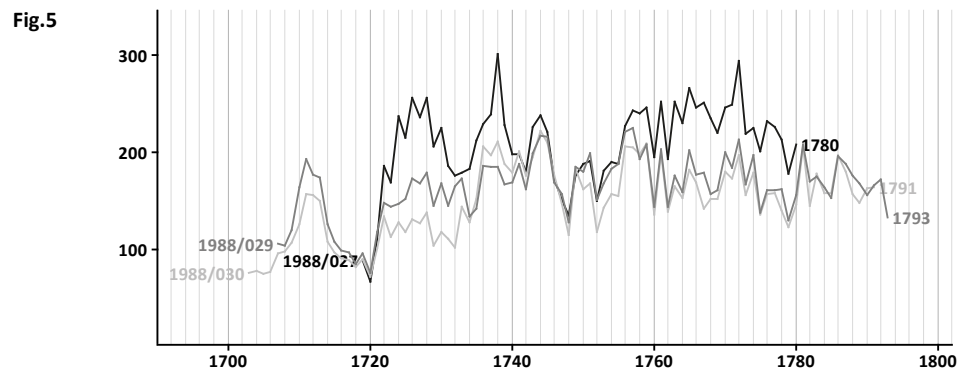

8. Technical Aspects

Dendrochronological analysis provides information on the construction technique of the soundboard. First of all, the number of parts which compose it is clearly identified and the direction of growth for each element is recognized.

Microscopic observation, which is essential for tree-ring measurement, also permits a clear distinction of the elements composing the soundboard. Furthermore, early- and late-wood of tree rings are identified in order to establish the direction of growth and therefore the arrangement of the boards. We also obtain a mean value of the tree-ring width and the standard deviation. All these parameters make it possible to characterize the instruments from both technical and acoustical points of view.

Even if the relation between ring-width and acoustical properties of wood is not systematic, in general, other conditions being equal, spruce wood with narrow tree-ring widths tends to vibrate longer and in higher tones [21], while wood with broad rings emphasizes deeper sounds [22, 23].

Fig.5 Agreement of the tree-ring series of three different instruments made by the same luthier, Valentino De Zorzi, kept at the Accademia Museum in Florence. The three series are very similar to each other, suggesting that the wood for the soundboard originated from the same trunk. $t_{BP,value} > 12$ confirms good visual agreement between the black and blue series.

The standard deviation, which expresses the dispersion of the data around the mean value, can be considered an index of the regularity of the annular tree-rings. In general, it has been observed [24] that spruce wood with irregular ring widths is not optimal for the production of soundboards because it has less homogeneous acoustical characteristics.

9. Conclusion

Dendrochronology enables reliable and independent determination of age, attribution to a specific violin-maker or violin-making school, identification of the area of the origin of the timber, as well as technical characterization of the soundboard. This is some of the possible information that can be provided by dendrochronological analysis, which is therefore an indispensable method of scientific analysis and should be applied prior to planning any intervention on any kind of musical instrument.

ACKNOWLEDGEMENTS: The research and international co-operation were initiated and supported by the COST Action FP1302, Wood Musick. The work of K. Čufar was also supported by the Slovenian Research Agency (ARRS) P4-0015 programme.

References

- [1] H.C. Fritts, *Tree Rings and Climate*. London: Academic Press, 1976.
- [2] K. Čufar, "Dendrochronology and past human activity – A review of advances since 2000," *Tree Ring Research*, vol. 63, no. 1, pp. 47–60, 2017.
- [3] K. Haneca, K. Čufar, and H. Beeckman. "Oaks, tree-rings and wooden cultural heritage: a review of the main characteristics and applications of oak dendrochronology in Europe." *Journal of Archaeological Science*, vol. 36, pp. 1–11, 2009.
- [4] W. Lottermoser and J. Meyer, "Über die Möglichkeit einer Dendrochronologie von altitalianischen Geigen," *Instrumentenbauzeitschrift*, vol. 12, pp. 295–296, 1958.
- [5] P. Klein, "Dendrochronologische Untersuchungen an Gemäldetafeln und Musikinstrumenten," *Dendrochronologia*, vol. 3, pp. 25–44, 1985.
- [6] E. Corona, "Ricerche dendrocronologiche su due violini del XVIII secolo," *L'Italia Forestale e Montana*, vol. 35, pp. 112–115, 1980.
- [7] P. Klein, H. Mehringer, and J. Bauch, "Dendrochronological and wood biological investigations on string instruments," *Holzforschung*, vol. 40, pp. 197–203, 1986.
- [8] V. Bucur, *Acoustics of Wood* (2nd ed., Springer Series in Wood Sciences). Berlin: SpringerVerlag, 2006.
- [9] C. Buksnowitz, A. Teischinger, U. Müller, A. Pahler, and R. Evans, 2007. "Resonance wood (*Picea abies* (L.) Karst.) – Evaluation and prediction of violin makers' quality grading," *Journal of the Acoustical Society of America*, vol. 121, no. 4, 2384–2395.
- [10] U. Wegst, "Wood for sound," *American Journal of Botany*, vol. 93, pp. 1439–1448, 2006.
- [11] M. Bernabei, J. Bontadi, and G. Rossi Rognoni, "A dendrochronological investigation of stringed instruments from the collection of the Cherubini Conservatory in Florence, Italy," *Journal of Archaeological Science*, vol. 37, pp. 192–200, 2010.
- [12] K. Čufar, M. Beuting, B. Demšar, and M. Merela, "Dating of violins – The interpretation of dendrochronological reports," *Journal of Cultural Heritage*, vol. 27S, pp. S44–S54, 2017.
- [13] N. Sodini, *et al.*, "Non-invasive microstructural analysis of bowed stringed instruments with synchrotron radiation X-ray microtomography," *Journal of Cultural Heritage*, vol. 13, no. 3, pp. S44–S49, 2012.
- [14] L. A. Larsson, *CDendro & CooRecorder* [computer software]. Sweden: Cybis Elektronik & Data AB. <http://www.cybis.se>
- [15] C. Sander and T. Levanič, "Comparison of t-values calculated in different dendrochronological programmes," *Dendrochronologia*, vol. 14, pp. 269–272, 1996.
- [16] M. G. L. Baillie and J. R. Pilcher, "A simple cross-dating program for tree-ring research," *Tree-Ring Bull*, vol. 33, pp. 7–14, 1973.
- [17] M. Kaennel and F. H. Schweingruber, *Multilingual Glossary of Dendrochronology* (WSL/FNP). Berne, Stuttgart, Vienna: Haupt Publishers, 1995.
- [18] UNI Standard 11141: Wood dendrochronological dating guidelines. Milan: Ente Nazionale Italiano di Unificazione, 2004.
- [19] M. Bernabei and J. Bontadi, "Determining the resonance wood provenance of stringed instruments from the Cherubini Conservatory Collection in Florence, Italy," *Journal of Cultural Heritage*, vol. 12, no. 2, pp. 196–204, 2012.

[20] K. Čufar, M. Beuting, and M. Grabner, "Dendrochronological dating of two violins from private collections in Slovenia," *Zbornik gozdarstva in lesarstva*, vol. 91, pp. 75–84, 2010. Available: <https://repozitorij.uni-lj.si/IzpisGradiva.php?id=28761&lang=eng>

[21] R. Ille, "Eigenschaften und Verarbeitung von Fichtenresonanzholz für Meistergeigen (II)," *Holztechnologie*, vol. 17, pp. 32–35, 1976.

[22] O. Blossfeld, W. Haasemann, and K. Haller, "Klangholz und Klangholzsortierung," *Deutsche Sozialistische Forstwirtschaft*, vol. 12, pp. 140–145, 1962.

[23] M. Bariska, "Zur Geschichte der Holzverwendung beim Musikinstrumentenbau," *Schweizerische Zeitschrift für Forstwesen*, vol. 147, no. 9, pp. 683–693, 1996.

[24] E. Zieger, "Untersuchungen über äußere Merkmale, Holzeigenschaften und forstgeographische Vorkommen der Resonanzqualitäten bei Fichte und einigen anderen Holzarten," *Mitteilungen aus der Staatsforstverwaltung Bayerns*, vol. 31, pp. 285–298, 1960.

Tropical and Traditional Wood Species in Musical Instruments and Case Studies of Their Substitution with Modified Wood

MARIO ZAUER (1), ALEXANDER PFRIEM (2)

(1) Institute of Natural Material Technology, Technische Universität Dresden, Germany

(2) Faculty of Wood Engineering, Eberswalde University for Sustainable Development, Germany

Abstract

Wood is still a preferred material for musical instruments. Worldwide, several hundred wood species are available for making wind, string or percussion instruments. Many of these wood species are cut down illegally. Some wood species are protected by the Convention on International Trade in Endangered Species (CITES). Today, there is an increasing demand to replace tropical wood species in musical instruments. Since the customer does not want to give up the usual quality, an optimal substitution of tropical woods with high-quality materials is indispensable. Therefore, the search for alternative wood species has to take into consideration anatomical features, as well as physical, mechanical, acoustical and chemical properties. This paper gives an overview of three case studies that were carried out by the authors in cooperation with industrial or practical partners, on the use of modified wood in musical instruments. In addition, it shows how the use of thermally modified wood can contribute to the raw material situation in musical instruments.

1. Introduction

Traditionally, wood is one of the most important materials for use in musical instruments. For centuries, the development and evolution of musical instruments was closely linked to the availability of the respective species of wood. This was associated with the fact that very different types of wood were used for availability reasons. So for centuries, customers had to live with an evolution of the instruments and also with a change of the applied wood species.

Today, the unique mechanical and acoustical properties of wood and its aesthetic appeal still make it the material of choice for musical instruments. Worldwide, several hundred wood species are available for making wind, string or percussion instruments [1]. Unfortunately, many of them are cut down illegally and some wood species (e.g., rosewood, some mahogany species and pernambuco) are protected by the Convention on International Trade in Endangered Species (CITES).

In this regard, the 17th CITES Conference of parties in October 2016 resulted in important changes in the handling and trade of tropical timber. New important tree species were included in Annex II and (EU) Annex B. For already protected types of wood, extensive changes were sometimes made in the footnote control. Thus, a variety of wood species—including the entire *Dalbergia* genus, over 250 rosewood species—have been placed under the comprehensive protection of CITES.

Even though musical instruments come to only a small fraction of the wood annually harvested in the tropics, the decision of 17th CITES Conference forced instrument-makers and traders to search for a suitable strategy for implementing these regulations. As a result of trade restrictions, producers of musical instruments are already facing increased bureaucracy and more cost pressure due to limited material availability and rising raw material prices. For example, according to market participants, prices for Honduran Rosewood (*Dalbergia stevensonii*) rose by up to 40% in 2017 compared to previous years. But not only CITES-protected wood species show high price increases. Wood species of the temperate zone, especially maple, are becoming increasingly expensive in the qualities relevant to musical instrument-making.

Today, the demand is increasing to replace tropical and other expensive wood species in musical instruments. Since the customer does not want to give up the usual quality, optimal substitution of tropical wood species with high-quality materials is indispensable. Therefore, the search for alternative woods has to take into consideration anatomical features and physical, mechanical, acoustical and chemical properties. According to Pfriem (2006), there are three different requirements for the wood species used in musical instruments depending on the component [2]:

- Requirements for sound behaviour – acoustic properties,
- High-dimensional stability and low water vapor sorption, and
- High hardness and strength.

There are also requirements regarding hygienic aspects and emissions. Acoustic properties for acoustic-relevant components such as dynamic Young's modulus, internal friction (or damping) and dynamic shear modulus of wood species can be measured using the experimental modal analysis [3].

This chapter gives an overview of three case studies on the use of modified wood in musical instruments. All of these studies were carried out with a practical partner and led to a commercial application and use of the material. In addition, it shows how the use of modified wood can contribute to the problematic raw material situation in musical instruments.

2. Case Studies: Modified Wood in Musical Instruments

2.1. Thermally Modified Wood in Acoustic Guitars

This first case study deals with thermal modification to improve the sound properties of spruce (*Picea abies* L.) soundboards and with the substitution of tropical hardwood (rosewood or mahogany) with thermally modified (TM) wood in acoustic guitars. This case study summarized different research and transfer projects, which were carried out in cooperation with industrial or practical partners who are using the results commercially.

Thermal modification of wood above 150°C causes partial degradations of cell wall components, which are primary hemicelluloses. This affects lower water sorption and improves dimensional stability and biological durability [4]. First scientific evaluations of thermal treatments (120°C–130°C) for musical instruments were assessed as unsuitable [5]. Initial attempts to use TM wood in musical instrument-making took place in the 1980s in Germany and later in the late 1990s in Finland [6]. Instruments made by the Finish Thermo Timbet Tonewood process were presented at Musikmesse Frankfurt in 1999 [7]. Kubojima *et al.* (2000) showed that relatively mild (160°C) and short-time (up to 4 h) thermal treatments lead to an improvement of dynamic Young's Modulus of modified Sitka spruce. At the same time, the toughness properties of the wood decrease with increasing intensity [8]. Later studies at Technische Universität Dresden (Germany) with higher temperatures showed clear improvements of the sound quality of spruce, especially for resonance soundboards, compared to untreated wood [2, 9], which is in line with other results reported [10]. Here, the aim of work was to compare relatively mild TM (180°C, 2-3 h duration) and unmodified twin samples of

resonance spruce wood for sound boards. By a specific thermal treatment, physical-technical characteristics of wood can be changed in such a way that they correspond better to the requirements of wood used for sound boards than unmodified wood species. Due to the thermal modification, objectively measurable parameters like dynamic Young's Modulus, speed of sound and damping are improved which permit conclusions on improved sound characteristics. First instruments with TM spruce top based on this study were commercialized at the Musikmesse Frankfurt in 2005.

A request of Pacific Rim Tonewoods, an American tonewood producer, led to investigations on whether the findings of the modification of spruce can also be transferred to Sitka spruce (*Picea sitchensis*). The aim of the investigations was to identify treatment parameters with low temperatures (160°C–175°C) to achieve an improved ratio of stiffness and density and a lower damping. Sitka spruce with dimensions of 540 x 200 x 30 mm³ was used for this investigation. The tonewood with very straight and regular growth was produced by a specialized sawmill and was cut to guitar soundboards with edges accurately parallel to the grain. Four different thermal treatment processes were applied, which represented the state of the art of the fundamentally different techniques, extant in Europe. Based on the experiences of the involved companies, the material was modified by mild treatments at relatively low temperatures (160°C–175°C for 2 to 4 h) to achieve an improved ratio of stiffness and density and lower damping. Thus, the aim of this study was to analyse the extent of the change of resonance behaviour of the modified material afterwards. Experimental modal analysis (see Fig.1) was carried out by exciting the boards with an impact hammer (PCB M086C01) over evenly distributed points on 11 samples per process before and after thermal treatments, e.g. using various industrial means and one lab-scale kiln. Basically due to different techniques and slightly different recipes, all thermal treatments cover a large range to see different effects on the resonance behaviour of the samples. Summarized, an improvement of the sound quality for all of the processes can be assumed, considering that some negative effects, like decreased MOE or increasing damping, were rather small.

The aim of the work in two research projects, financed by the German Ministry for Economic Affairs and Energy with two different German guitar producers, was the development of substitutions for tropical hardwood species in guitars. Thermal wood modification was used to modify European hardwood species to receive acoustical and optical properties close to the properties of tropical hardwood. It is essential to characterize the wood species actually used for guitar production to find other suitable wood species afterwards. Here physical properties like density, Young's modulus, modulus of rupture, Brinell hardness,

Fig.1



dynamic Young's modulus, damping coefficient and dynamic shear modulus in LR-plane of tropical hardwood species namely Brazilian and Indian rosewood, Zircote, African blackwood and Ebony were investigated [3]. In order to obtain a broad database of native wood species, 17 native European wood species were included in the investigations to be able to compare their sound behaviour with the tropical wood species used as standard.

These analyses then served to develop the thermal modification processes and were thus used to continue the selection of materials. Since the different components, such as the body, neck and fingerboard, also give different demands on the material, a component-specific development of the modification processes becomes necessary. Here, the search for the ideal degree of modification of the various wood species (in terms of treatment temperature and time) is targeted at coming closest to the natural, tropical role models. The timing of the treatment was based on the desired intensity of compensation. The investigations showed that the density values of all types of wood have decreased as expected due to the modification. The modulus values of the modified materials showed slight increases in the samples of the alder (*Alnus glutinosa* L.) and cherry (*Prunus avium* L.) species, while the Young's modulus for the species pear, spruce and cedar remained the same on average. Thermal modification not only results in loss of mass but also in a decreased moisture content. This slight increase or stabilization of stiffness is based on a balance in the lower moisture content of the modified wood and the slight reduction of density [11].

Fig.1 Experimental setup for modal analysis: impact hammer (1), sensor (2), sample (3), front-end (4) and computer (5).

Because of the best balance between mass loss and improvement in stiffness, alder wood and fruit wood species are particularly suitable as alternatives for tropical hardwood species used in sides and backs of guitars. The component-specific modification processes were applied to the previously selected materials for various wood components of guitars. The selected and tested materials were used to make the individual instrument components or instruments. Here, identical “twin-instruments” based on tropical and alternative modified wood were built. Comparative acoustic tests were performed by a frequency curve comparison by impact methods (comparative to **Fig.1**) and Microphone recordings in a silenced test chamber (see **Fig.2**) of the manufactured guitars. Both tests showed that the tropical wood guitars and the TM guitars have similar performances in acoustic behaviour. These results were confirmed through play tests by professional musicians.

2.2 Thermally Modified Wood in Electrical Bass Guitars

The following case study deals with the thermal modification of European beech (*Fagus sylvatica* L.) to improve the physical properties, especially acoustic behaviour, for use in the neck of electric bass guitars, as a highly stressed component of musical instruments [12]. The neck of an electric bass guitar is responsible for transferring high forces and for the sound behaviour of the whole instrument [13]. Due to the low acoustic quality (e.g., high damping) and generally poor reputation of beech, the wood is used only occasionally for plucked and bowed string instruments. In addition, the low dimensional stability, high swelling and shrinking behaviour, in different climatic environment conditions, is an extremely limiting aspect. However, in Europe, particularly in Germany, the wood is present and abundant.

Within the scope of the study, a thermal treatment procedure using relatively low treatment temperatures of 140°C and 160°C over a treatment time of 12 h has been developed to improve the properties of beech to substitute the commonly used wood species Hard maple (*Acer saccharum*). The relative “mild” temperatures were chosen to avoid the well-known reduction in strength owing to thermal modification at usually used temperatures between 180°C and 220°C [4, 14]. The improvement of the acoustic and mechanical properties using the relative low temperatures was expected because of both the increase in the crystallinity index [10] and the simultaneous decrease in the equilibrium moisture content (EMC) [11] due to the transformation processes of the cell wall components, especially the hemicelluloses and amorphous parts of cellulose. In this connection, the reduced EMC of thermally modified (TM) wood obviously has the greatest impact [11].

Thermal treatment was conducted on matched boards which were dried at 80°C before being sealed using a special thermally stable film

Fig.2



Fig.2 Acoustical testing of a guitar made with thermally modified wood.

to realize an exclusion of oxygen during the treatment procedure. The sealed wood packages were vacuumed and transferred into a laboratory oven for treatment (see Fig.3). In addition to the use of low temperatures, both oxidation and hydrolysis processes during thermal treatment were significantly reduced due respectively to the wood preparation and atmospheric condition that were used.

The comparative investigations were conducted on 1) the solid material: untreated Hard maple, untreated beech, TM beech—with experimental modal analysis (EMA), bending and impact bending tests, swelling behaviour and equilibrium moisture content tests; and 2) complete bass guitar necks by means of EMA and whole electric bass guitars by means of a special automatic plucking apparatus [15] (see Fig.4).

The results (Table 1) show that, due to thermal modification, the EMC and volume swelling (VS) of beech decrease, whereas density was not altered. The mechanical properties, modulus of rupture (MOR) and modulus of elasticity (MOE), increased as a result of the thermal modification procedure used. The acoustic properties (damping and resonance quality (R)) also improved. Likewise, all damping values of the bass guitar necks constructed of TM beech are similar to or even better than the necks constructed of Hard maple. In particular, the damping value determined at the first torsion vibration, which is very important for the acoustic behaviour of the neck, as well as the whole electric bass guitar, show a strong improvement owing to thermal modification. The results: attack and sustain determined by means of the automatic plucking tests show an equivalence between the bass guitars constructed of TM beech and Hard maple.

Fig.3

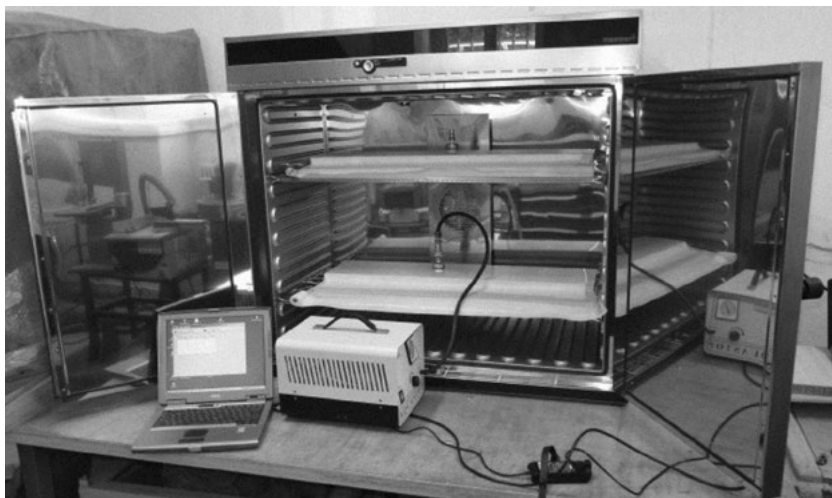

Fig.3 Sealed wood packages in a lab oven during the vacuum procedure.

Fig.4



Table 1

Property	Hard maple	European beech		
		untreated	TM 140	TM 160
Pure material				
Density (kg m ⁻³)	690	690	700	680
EMC (%)	9.2	8.7	5.8	5.1
VS (%)	4.4	5.0	4.7	4.2
MOR (MPa)	127	129	140	134
MOE (MPa)	1390	1370	1460	1520
Damping (-)	0.6	0.7	0.6	0.5
R (m ⁴ s ⁻² kg ⁻¹)	7	6	7	7
Damping values of the bass guitar neck at the appropriate mode vibration				
1 st Bending	0.39	0.42	0.39	0.37
1 st Torsion	0.45	0.56	0.46	0.41
2 nd Bending	0.51	0.52	0.50	0.47
Attack (10 ⁻³ s) / sustain (s) of the whole bass guitar of the appropriate open string				
E ₁	26.0/13.0	34.0/12.1	29.0/12.5	24.0/12.9
A ₁	64.0/18.0	74.0/15.9	64.0/15.8	62.0/17.7
D ₂	27.0/11.2	28.0/10.3	27.0/10.6	27.0/10.6
G ₂	19.0/9.4	21.0/9.1	20.0/9.9	20/9.6

Fig.4

Automatic plucking apparatus for the determination of the attack and sustain of an electric bass guitar.

Table 1

Comparison of the results determined on the solid material, on the bass guitar necks and on the whole electric bass guitar in climated state of the specimen at 20°C and 65% RH.

In sum, the properties of the solid material, the single component (bass guitar neck), and the whole musical instrument (electric bass guitar) were improved owing to thermal modification of the beech wood at 140°C and 160°C for 12 h, analogously to the properties of Hard maple. Thus, the substitution of Hard maple with European beech thermally modified at relative low or mild treatment temperatures was determined feasible.

2.3 Chemically Modified Wood in Violins (Fingerboard)

It is well-known that wood densification leads to improved mechanical properties, such as hardness and stiffness [16]. However, densified wood is not dimensionally stable due to springing back into its original dimension [17]; in other words, densified wood does not remain in the form-fixed state. Furfurylation of wood is a known wood chemical modification method. A combination of furfurylation and wood densification has already been described [18]. In this connection, the forming polymer accomplishes the task of fixation of the densified wood structure which could be proven in several studies [19, 20].

The focus of a practice-oriented study [21] was the development of a combined modification procedure: furfurylation and densification for the manufacture of violin fingerboards to replace ebony (*Diospyros spec.*), one of the wood species most used in this sector. In addition to the strict regulations in the CITES annex, reliable availability of high-quality ebony is not the case now or in the foreseeable future. Today it is very difficult to have a good range of products on the market, and often the sources are illegal or suspect. It appears clear that substitution materials will be needed in the future.

Within the scope of the study, European beech (*Fagus sylvatica* L.) and Sycamore maple (*Acer pseudopatanus* L.) were combined modified (see Fig.5).

The impregnation solution consisted of 50% furfuryl alcohol, 50% acetone as a diluent and 5% maleic acid anhydrite as a catalyst. The process of impregnation was conducted by means of a vacuum pressure procedure, and the process of densification was conducted by means of a hot press (150°C). The pressing velocity was 1 mm min⁻¹. The samples were densified in radial cutting direction of the wood, in which the percentage densification was 30%. Finally, the samples were treated at 103°C for 24 h (curing procedure).

Swelling coefficients of the samples were obtained by means of cyclic climate tests. In this connection, oven-dried samples were conditioned at 20°C and 90% relative humidity until EMC was reached. The mass and dimensions of both oven-dried and conditioned samples were determined. Afterwards, the samples were gently oven-dried again, wherein this climate cycle was conducted three times. The results, for

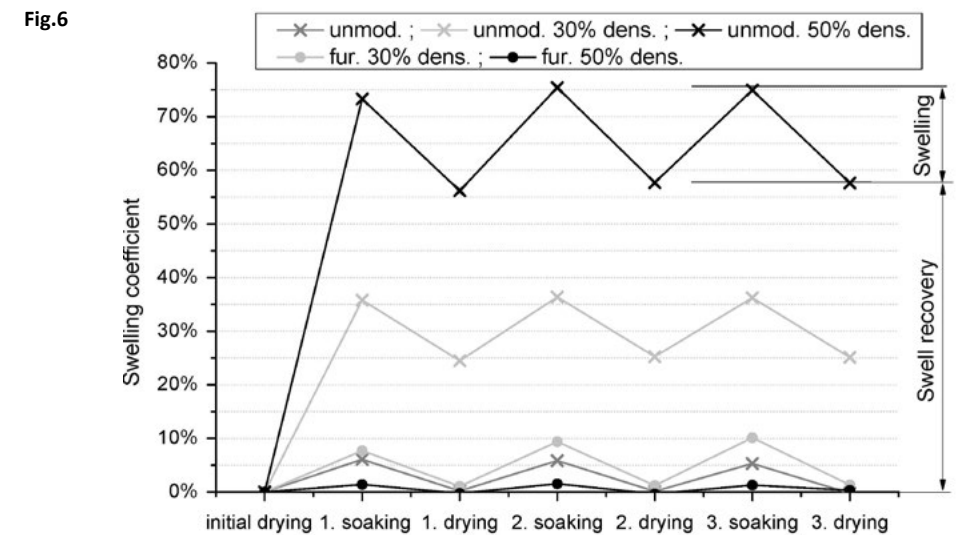
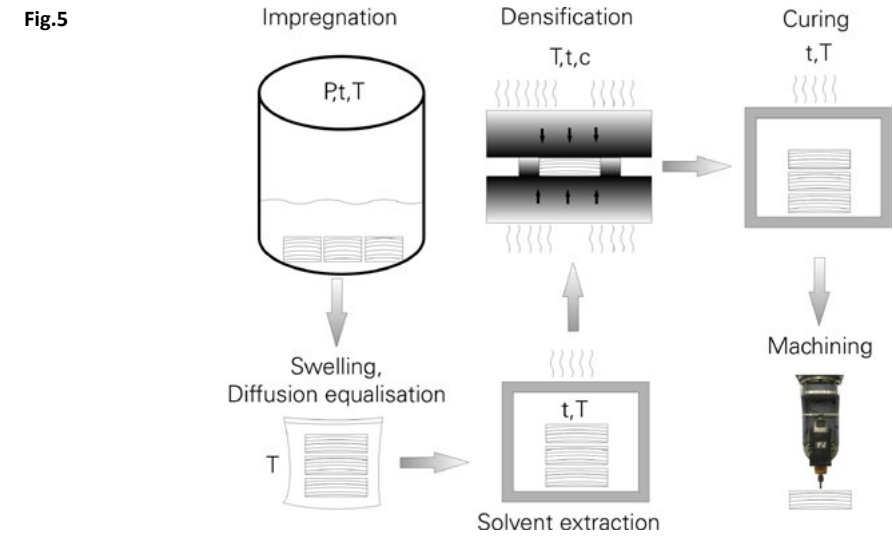

example on beech wood (see Fig.6), show a significant improvement of both dimensional stability (lower swelling) and shrinking and form fixation (lower swell recovery) of the densified wood due to modification by furfuryl alcohol, compared to densified beech wood without modification.

Fig.5 Treatment scheme of the combined furfurylation and densification of wood.
Fig.6 Swelling coefficient of beech; densified (30% and 50%), densified and modified, unmodified; data adapted from [20].

Mechanical properties were determined by means of bending tests and Brinell hardness tests. The results show an improvement of the modulus of elasticity (MOE) and hardness (HB) because of the combined modification procedure comparable to those of ebony (see **Table 2**).

Table 2

Property	Ebony	Modified beech	Modified maple
MOE [MPa]	10300	17000	13400
HB [MPa]*	110	100	70

*Load applied for hardness test was 2000 N

Furthermore, the amount of volatile organic compounds (VOC) of the modified wood were determined to assess the emissions during processing (e.g., milling of the fingerboard) and use (e.g., playing the instrument). For the cooperating company, these investigations were an essential aspect, both for taking protective measures during processing and for the general marketing of the products (fingerboards). The examinations were conducted by means of a gas chromatography-mass spectrometry (GC-MS) apparatus and evaluated according to the guidelines of the Committee for Health-related Evaluation of Building Products. These guidelines, made for construction products or indoor air quality in living rooms, seem appropriate for evaluating the VOC of modified violin fretboards in daily use.

Fig.7

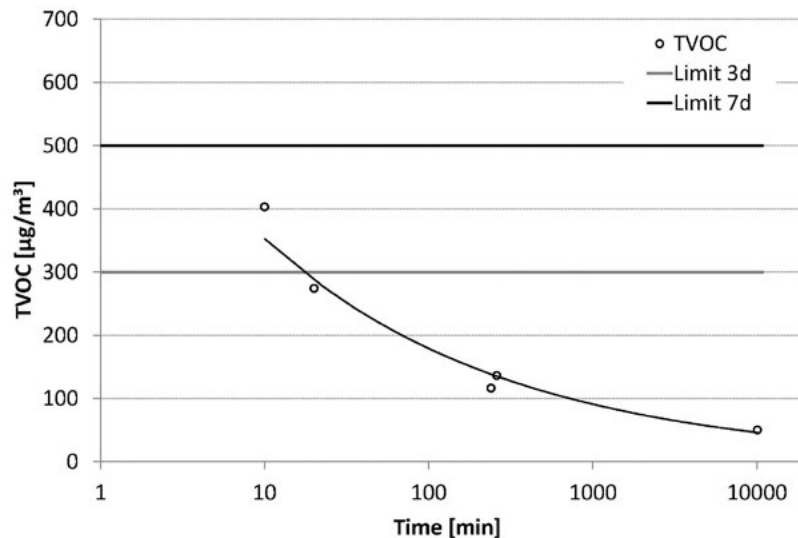

Table 2 Modulus of elasticity (MOE) and Brinell hardness (HB) of ebony, modified beech and modified maple.

Fig.7 Development of single health-related components (furfural, acetic acid) of freshly cut samples depending on storage time of an electric bass guitar.

The results of the total VOC (TVOC) measurements (see **Fig.7**) show that such components are existent and fumigate.

The values are partially slightly above the three-day limit. However, due to sample storage for a few days, the volatile health-related components are largely volatilized. Thus, the indoor air quality and the health of the musician are not endangered (marketing opportunity). However, the worker who is processing the modified wood is endangered because the VOCs are stored in the wood structure. Every new cut opens a fresh surface through which the stored volatile components are emitted. The worker is immediately exposed to the health-related components. Thus, appropriate protective measures (e.g., gloves, mask or central suction) must be used to protect the people who process (e.g., mill or sand) this chemically modified material.

Finally, fingerboards of unmodified and modified beech and maple were produced and compared with fingerboards made of ebony (see **Fig.8**).

The results obtained from the manufacture show that modification leads to embrittlement, and thus the material shows differences compared to ebony. Tool wear is faster compared to ebony. Furthermore, the generation of a smooth surface for fretboards processed manually using traditional tools is difficult owing to the formation of shorter chips (brittle material). Hence, processing by means of a CNC machine, in which the processing parameters have to be adapted to the modified material, is required. In order to prevent contact with released VOCs, preferably extensive exhaust ventilation during machine-processing is needed. According to the cooperating company, both gluability and colourability of the modified material is similar to ebony. Thus, there is no special expenditure involved in processing compared to that of ebony.

Fig.8

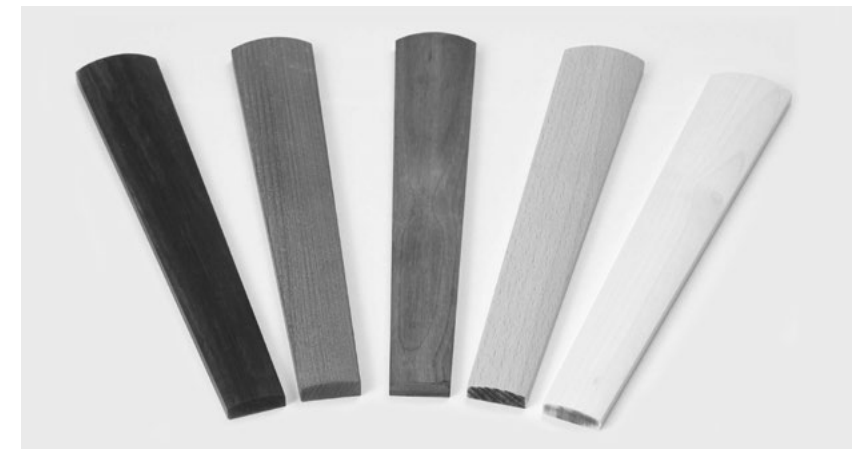

Fig.8 Fretboards of violins: ebony, modified beech and maple, untreated beech and maple (LTR).

3. Conclusions

The case studies show that a partial substitution of tropical hardwood with European hardwood is possible. All of the results aimed for a practical application. Therefore, all examinations took place in close cooperation with practice partners. Different applications in different parts of musical instruments were shown and are now being transferred into real products. Mild thermal treatment (modifying at 160°C–180°C in oxygen-poor atmosphere) of European hardwood species leads to clear changes of the measurable acoustic characteristics, such as Young's modulus, damping and sound velocity. In conclusion, mildly thermally modified wood is a material with favourable characteristics for musical instrument-making and one alternative for tropical hardwood species, especially for the back and sides of guitars.

Similarly, there are also substitute materials for highly stressed components, such as guitar necks, as well as ebony in fingerboards. However, a pre-selection of the raw materials is absolutely necessary. Inappropriate materials can hardly be improved by modification procedures. Due to these investigations, traditional production technologies of musical instrument-making can be transferred for use of modified wood in musical instruments. But the potential of European hardwood species for making musical instruments should be more fully exploited overall. For this purpose, parameter studies on the acoustic properties of European wood species and their comparison with tropical wood species are absolutely necessary. Finally, rethinking on the part of the consumer has to take place in order to achieve broad acceptance of the alternative materials and wood species.

ACKNOWLEDGEMENTS: Support from the COST Action FP1302 WoodMusICK, financial support from the German Federal Ministry for Economic Affairs and Energy for research projects (Grant No. KF2418607CK1; KF2418610CK2; KF2122220CK4) and for the support of the network-project SubMat4Music (Grant No. 16KN072601) are gratefully acknowledged.

References

- [1] U. Wegst, "Wood for sound," *Am. J. Bot.*, vol. 93, pp. 1439–1448, 2006.
- [2] A. Pfriem, "Untersuchungen zum Materialverhalten thermisch modifizierter Hölzer für deren Verwendung im Musikinstrumentenbau," Dissertation, TU Dresden, 2006.
- [3] R. Sproßmann, M. Zauer and A. Wagenführ, "Characterization of acoustic and mechanical properties of common tropical woods used in classical guitars," *Results in Physics*, vol. 7, pp. 1737–1742, 2017.
- [4] C. A. S. Hill, *Wood Modification: Chemical, Thermal and Other Processes*. Chichester: Wiley, 2006.
- [5] C. Gadd and J. D'Arcy, "On the effect of heat treatment upon acoustic properties of spruce," *J. Violin Soc. America*, vol. 7, pp. 157–166, 1986.
- [6] C. Gütter, K. Eichelberger, F. Pods, G. Seeberger and G. Ziegenhals, "Erfahrungen bei der Anwendung von thermisch modifiziertem Holz im Gitarrenbau in den letzten 15 Jahren," in A. Wagenführ, Ed., *Proc. 18th Holztechnologisches Kolloquium*, Dresden, 2018.
- [7] H. Thomson, "Thermo-treated wood. Vintage tone or voodoo from Finland?" *The ToneQuest*, vol. 7, pp. 11–16, 2006.
- [8] Y. Kubojima, T. Okano and M. Ohta, "Bending strength and toughness of heat-treated wood," *J. Wood Science*, vol. 46, pp. 8–15, 2000.
- [9] K. Eichelberger, "Einsatz von durch thermische und thermomechanische Verfahren verbesserte Hölzer im Musikinstrumentenbau," Abschlussbericht Institut für Musikinstrumentenbau Zwota an der TU Dresden, 2005.
- [10] Y. Kubojima, T. Okano and M. Ohta, "Vibrational properties of Sitka spruce heat-treated in nitrogen gas," *J. Wood Science*, vol. 44, pp. 73–77, 1998.
- [11] B. Marcon *et al.*, "Kinetic analysis of poplar wood properties by thermal modification in conventional oven," *iForest*, vol. 11, pp. 131–139, 2018.
- [12] M. Zauer, A. Kowalewski, R. Sproßmann, H. Stonjek and A. Wagenführ, "Thermal modification of European beech at relatively mild temperatures for the use in electric bass guitars," *Eur. J. Wood and Wood Products*, vol. 74, pp. 43–48, 2016.
- [13] R. Sproßmann, M. Zauer, A. Pfriem and A. Wagenführ, "Zum Einfluss der Holzart in Bassgitarrenhälsen auf das Schwingungs- und Klangverhalten," *Holztechnologie*, vol. 54, pp. 19–25, 2013.
- [14] M. Zauer and A. Pfriem, "Reinforcement of thermally modified wood for use in highly stressed components of musical instruments," in C. A. S. Hill, H. Militz and B. Andersons, Eds., *Proc. 5th European Conference on Wood Modification*, 2010.
- [15] M. Zauer, R. Sproßmann, H. Stonjek and A. Wagenführ, "Determination of acoustic properties of electric bass guitars by means of an automatic plucking apparatus," *COST Action FP 1302 Wood-MusICK Conf.*, Cremona, 2015.
- [16] R. M. Seborg, M. A. Millet and A. J. Stamm, "Heat stabilized compressed wood (Staypak)," *Mechanical Engineering*, vol. 67, pp. 25–31, 1945.
- [17] P. Navi and F. Girardet, "Effects of thermo-hydro-mechanical treatment on the structure and properties of wood," *Holzforschung*, vol. 54, pp. 287–293, 2000.
- [18] A. Pfriem, T. Dietrich and B. Buchelt, "Furfuryl alcohol impregnation for improved plasticization and fixation during the densification of wood," *Holzforschung*, vol. 66, pp. 215–218, 2012.
- [19] T. Dietrich, B. Buchelt, A. Pfriem and A. Wagenführ, "Properties of Furfuryl alcohol modified and densified Beech wood (*Fagus Sylvatica* L.)," in D. Jones *et al.*, Eds., *Proc. 6th European Conference on Wood Modification*, 2012.
- [20] B. Buchelt, T. Dietrich and A. Wagenführ, "Testing of set recovery of unmodified and furfurylated densified wood by means of water storage and alternating climate tests," *Holzforschung*, vol. 68, pp. 23–28, 2014.
- [21] T. Dietrich, B. Buchelt and A. Wagenführ, "Modified wood as substitute for ebony wood in musical instruments," in L. Nunes, D. Jones, C. A. S. Hill and H. Militz, Eds., *Proc. 7th*

Assessing the Impact of Conservation Materials on the Acoustic Properties of Woodwind Musical Instruments

Efstathios Doganis (1), Sandie Leconte (2),
Anastasia Pournou (1)

(1) Technological Educational Institute of Athens, Greece

(2) Musée de la musique, Cité de la musique – Philharmonie de Paris, France

Abstract:

This work presents two different approaches for assessing the impact of conservation materials on the acoustic properties of woodwind historical instruments. Two acoustic methods were investigated: I) spectral analysis of radiated sound and II) input acoustic impedance. The conservation materials tested were five adhesives/fillers including an ethyl methacrylate co-polymer (Paraloid B-72), a polyvinyl acetate glue (Ravemul M18), an epoxy resin (Araldite precision), an animal glue (fish glue) and a mixture of wax and polyterpene resin (Lascaux Adhesive Wax 443-95). In both methods investigated, the sound spectrum of woodwind instruments was assessed a) at a baseline condition (undamaged), b) after developing an artificial crack and c) after repairing the crack with the different conservation materials. Results obtained by acoustic methods, indicated that the most appropriate conservation material for repairing a crack was the Lascaux mixture of wax and resin, followed by Paraloid B-72. Even though Lascaux performed very well in terms of acoustics and showed excellent adhesion properties and elasticity, its behaviour over time requires further research before recommending its use. Both methods used for assessing the impact of conservation materials on the sound were successful; however, input acoustic impedance was proved to be superior in many aspects compared to spectral analysis of radiated sound. Nevertheless, both methods reached the same conclusion in relation to the conservation materials tested, demonstrating reliability and making apparent that in the field of woodwind musical instrument conservation/restoration, testing a material before application should be a prerequisite.

1. Introduction

According to the original Hornbostel-Sachs [1] system classification, woodwinds are aerophones that produce sound by vibrating columns of air. Aerophones include different types of flutes, reeds (saxophones, oboes, clarinets, etc.) and brass instruments (trumpet, horn, etc.). Traditionally, woodwind instruments are made of fine-structure wood that has the ability to maintain its original dimensions while exposed to high levels of moisture. Some common wood species used for making such instruments are African blackwood (*Dalbergia metanoxylon*), Brazilian rosewood (*Dalbergia Nigra*), Macassar ebony (*Dyospyros celebica*), and maple (*Acer platanoides*) [2].

The causes of woodwind deterioration can be distinguished as endogenous and exogenous. Endogenous include wood defects (i.e., knots, wane, stain, checks), natural aging of wood chemical components and natural variation of wood physical properties. Deterioration of endogenous causes is directly related to sound quality and can worsen over time, especially when environmental conditions favour it. Exogenous causes derive mainly from the instruments' direct and indirect environment. All materials in contact with a musical instrument can be considered as the direct environment, whereas an indirect environment would be the surroundings, more specifically biotic and abiotic environmental parameters present in storage, exhibition or use of the instrument. One of the most important indirect exogenous factor is considered to be anthropogenic, as humans are responsible for different types of damage to musical instruments. These can occur by playing the instrument, either properly or incorrectly, but also through deliberate vandalism.

Another important indirect exogenous cause of deterioration is related to change of relative humidity and temperature. Moisture influences all the physical, mechanical and acoustic properties of wood. Being hygroscopic, woodwinds absorb water molecules when found in high relative humidity environments, whereas dry conditions cause the evaporation of water to the environment. These reactions take place in order to reach an "equilibrium state". The same phenomenon also occurs inside the instrument's pipe, due to condensation of the water vapour that comes from the breath of the musician. When using an instrument, wood is already in a state of balance with its external environment and therefore when moisture enters, this equilibrium is disturbed, forcing wood to re-establish it by water evaporation. The final moisture content of wood is determined by the difference between the moisture absorption rate inside the instrument, to the velocity of expelling moisture to the outside [3] [4].

Changes in moisture in wood tissue are always accompanied by changes in its dimensions, as opposed to other materials, in which such changes are often related to temperature instead of humidity. The

anisotropy of shrinkage and swelling of the wood can cause significant changes in woodwind instrument dimensions as well as their shape, and as a result of continuing humidity fluctuations, permanent deformations, cracks and breaks may be developed [5-8]. This is why the most commonly documented deterioration factor in woodwind instruments is cracking and fractures [4].

According to the current literature, very few data are published on adhesives used in the conservation of woodwind instruments. Furthermore, the related research is outdated and none takes into consideration the criterion for evaluating the impact on the sound of instruments. The most well-known methods for restoring cracks from woodwind instruments were "pinning" (pins are holding the crack placed inside the wood), filling with glue and wood dust, or placing a metal ring around the body of the instrument. According to professional woodwind makers, pinning was the best method because thereby the pin becomes part of the wood [8]. According to Zadro [3], the most recommended glues are epoxy, resorcinol formaldehyde, urea formaldehyde and some aliphatic resins, whereas the non-recommended materials include fish glue and animal glues in general, as they are susceptible in high-moisture conditions and lose strength and crystallize with age. However, none of these materials has been ever comparatively evaluated or assessed for its impact on the sound of instruments.

Therefore, this research was set up to comparatively examine various adhesives/fillers used in wood conservation and evaluate their suitability for woodwind musical instruments as well as their impact on the instruments' sound properties. The adhesives under investigation were selected according to their properties, such as stability over time, reversibility, properties after hardening (colour, elasticity), ease of application as well as low toxicity. Concerning the evaluation of their impact on the instruments' sound, two different methods were used to characterize their acoustic properties: I) input acoustic impedance, and II) spectral analysis of radiated sound.

The input acoustic impedance offers information about the sound characteristics of an instrument like the notes pitch without playing it. The input acoustic impedance is the ratio of the acoustical pressure over the acoustical flow at the beginning of a tube. It characterizes the acoustical waves, which propagate inside a tube (stationary waves). A signal is emitted at the beginning of the tube thanks to a speaker, and the reflected wave is measured with a microphone. The emitted signal is a frequency modulation. This technique directly provides the resonance frequency of the instrument, which is very close to the playing frequencies. The fingerings can be simulated by closing the holes and thus every note can be played and measured. It is a technique employed often to

study historical instruments that cannot be played and this is aligned with conservation and museological ethics [9]. In contrast, spectral analysis of radiated sound is an alternative experimental technique, of low cost and non-demanding infrastructure that can also allow the acoustics of woodwind instruments to be studied.

Fig.1

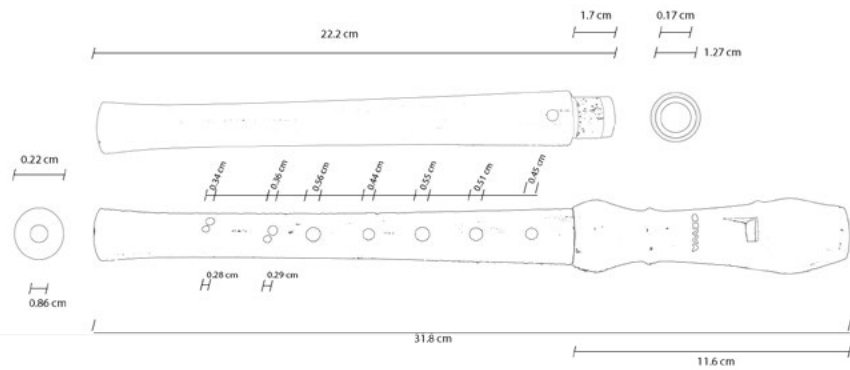

2. Materials and Methods

2.1. Mock-Ups Preparation

For the experimental procedure, two types of mock-ups were used: I) five bamboo flutes for spectral analysis of radiated sound, as common woodwind instruments used by several civilizations around the world, II) four wooden recorders for the input acoustic impedance experiment, as they are very common European woodwind instruments. The flutes had a length of 380 mm a diameter of 15 mm and 6 holes of ~0.8 cm diameter along the pipe. They were labelled with different coloured tapes (white, orange, green, yellow and pink) and respectively named F1, F2, F3, F4 and F5. The wooden recorders (baroque fingering) made of maple wood by Gawa, were 318 mm long and had a diameter of 21 mm [Fig.1].

The recorders were numbered from 1 to 4 and labelled with archival paper tape. After measuring and documenting flutes and recorders, an artificial crack was developed on both types of instruments. The cracks that typically form in woodwind instruments are found between the holes. For this reason, and to be consistent with real-life instruments, holes between 12 and 14 mm in length were created between the third and fourth hole of each flute. The cracks were made by a cutter. The crack's height was around 0.5 mm. to 0.8 mm. In the wooden recorders, the artificial crack was made in the thumb hole at

Fig.1 Recorder dimensions.

Fig.2

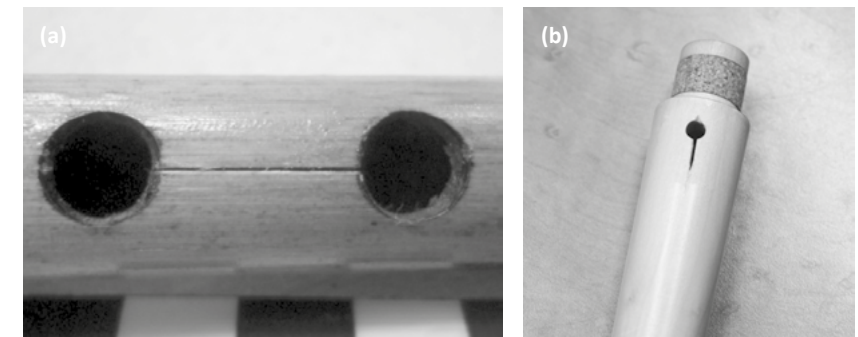

Table 1

Recorder	Flute	Adhesive/filler	Name
1	F4	Microcrystalline wax and polyterpene resin	Lascaux Adhesive Wax 443-95
2	F3	Protein based glue	Fish glue
3	F5	Ethyl methacrylate copolymer	Paraloid B72 40% w/v in acetone
4	F2	Polyvinyl acetate glue	Ravemul M18 Vinavil
-	F1	Epoxy	Araldite precision

the back [Fig.2], also with a cutter. The crack was near 1 mm width and 7.4 mm height in all recorders [Fig.2].

The conservation materials selected for filling cracks are commonly used as adhesives or fillers. These were fish glue (a proteinaceous adhesive) commonly used for woodwind repairs, and a mixture of microcrystalline wax and a synthetic polyterpene resin Lascaux. This material was selected as it is the closest equivalent to a traditional material used for the restoration of wooden instruments in Greece called “keromasticho”, which is a blend of beeswax and mastic resin. For comparative purposes, three more adhesives were chosen: I) Ravemul M18 Vinavil, a polyvinyl acetate adhesive the white glue typically used for woodworking, II) Paraloid B72, an ethyl methacrylate copolymer for its great durability and reversibility, and III) an epoxy resin (Araldite precision) (Table 1). All materials were used as fillers and placed on the cracks with a paintbrush except Lascaux, which was applied with a heated spatula. To avoid uneven application and the formation of a rough surface inside the instrument, a Melinex polyester film was rolled and secured in the tube.

Fig.2 The artificial crack developed on the flutes (a) and recorders (b).
Table 1 The adhesive/fillers investigated.

The sound of both flutes and recorders was documented a) in undamaged condition, b) after the development of the artificial crack, and c) after repairing the crack with each one of the five adhesives/ fillers for assessing the impact of conservation materials to the sound.

Fig.3

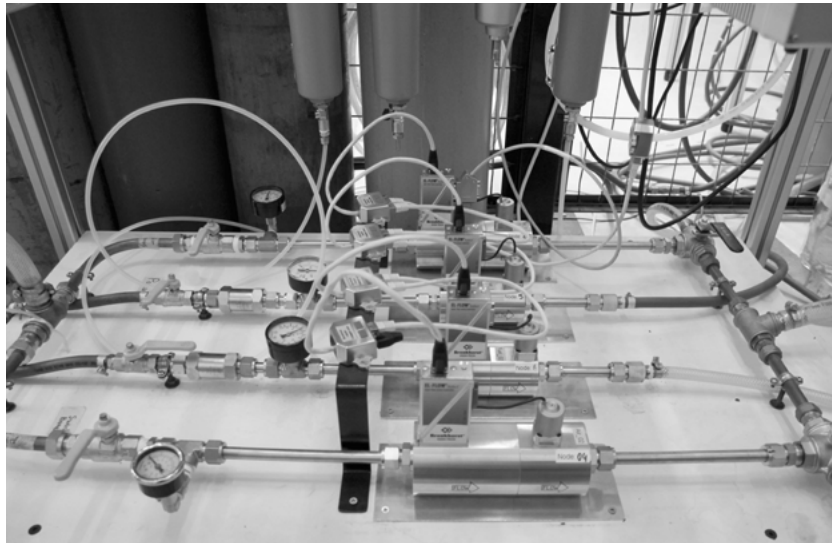

Fig.4



2.2. Spectral Analysis of Radiated Sound

An air compressor (Jun-air) was used to blow air into the instrument, providing a stable airflow of 5 mbar pressure and thus rendering the experiment reliable and repeatable. The compressor was connected to a mass flow controller [Fig.3] (Bronkhost F-202 AV-M20), monitoring temperature fluctuations via a temperature sensor. The flutes were

Fig.3 Mass flow controller.

Fig.4 Insulating tape used to close the flute holes.

Fig.5



tested in relation to the amount of airflow entering the pipe in eight fingering positions [Table 2]. The air supply was delivered through a hose from the controller into the mouthpiece of the flute, where the holes were closed with insulating tape in order to change the fingering position while recording and avoid loss of air [Fig.4].

The sound was recorded by a large diaphragm microphone, (Rode, NT1-A). The recording frequency range was 20 Hz to 20 kHz. The distance between the microphone and the edge of the flute was 135 mm [Fig.5]. The microphone was connected to a computer via a Behringer Europack and recorded in audio software (Audacity 1.2.5) as Wave. The sound was analysed with Fast Fourier Transform FFT. The results were exported as diagrams in which the abscissa displayed the frequency in Hertz (Hz) and the ordinate the amplitude in decibels (dB, dBFS). During the experiment the temperature was 20°C and the relative humidity (RH) was 55% ± 5. The experiment took place in the Laboratory of Heterogeneous Mixtures and Combustion Systems at the National Technical University of Athens (NTUA). Documenting the

Fig.5 Microphone positioning and set up.

sound in both the undamaged and artificially cracked states took place on the same day, whereas recording the repaired instruments took place 48 hours later, to allow the adhesive/filler to dry naturally.

The sound spectra of the flutes were studied in eight different fingering positions, as shown in **Table 2**. For each fingering position, a different airflow was used in order to have the correct note.

Table 2

Octave	FP	Close/open holes	Air flow lt/min
1st	1st	① ② ③ ④ ⑤ ⑥	5,57
2nd		① ② ③ ④ ⑤ ⑥	12,719
1st	2nd	① ② ③ ④ ⑤ ⑥	8
2nd		① ② ③ ④ ⑤ ⑥	11,53
1st	3rd	① ② ③ ④ ⑤ ⑥	8
2nd		① ② ③ ④ ⑤ ⑥	11,53
1st	4th	① ② ③ ④ ⑤ ⑥	8
2nd		① ② ③ ④ ⑤ ⑥	12,719

Fig.6



Table 1 Fingering positions (FP) with the respective air flow. Black circles correspond to closed holes and white to open ones.

Fig.6 Recorders used for the experiment at the Cité de la Musique.

2.3. Input Acoustic Impedance

Input acoustic impedance was implemented at the conservation laboratories of the “Cité de la musique” of Paris on four wooden recorders **[Fig.6]**.

For the experimental set up, the sensor was initially calibrated and tested using the formula $F=2n-\frac{1}{4} * C/L^1$. Then, the mouthpiece of the recorder was removed, and the diameter of the body was measured in order to add the information to the software. After the instrument’s body was placed on the sensor **[Fig.7,8]**, the input acoustic impedance of the instrument was measured. The duration of the signal was 9 seconds. To test the reliability of the results, some instruments were tested more than twice. All the recorders were recorded in 8 different fingering positions. During the experiment the temperature was 20°C.

Fig.7

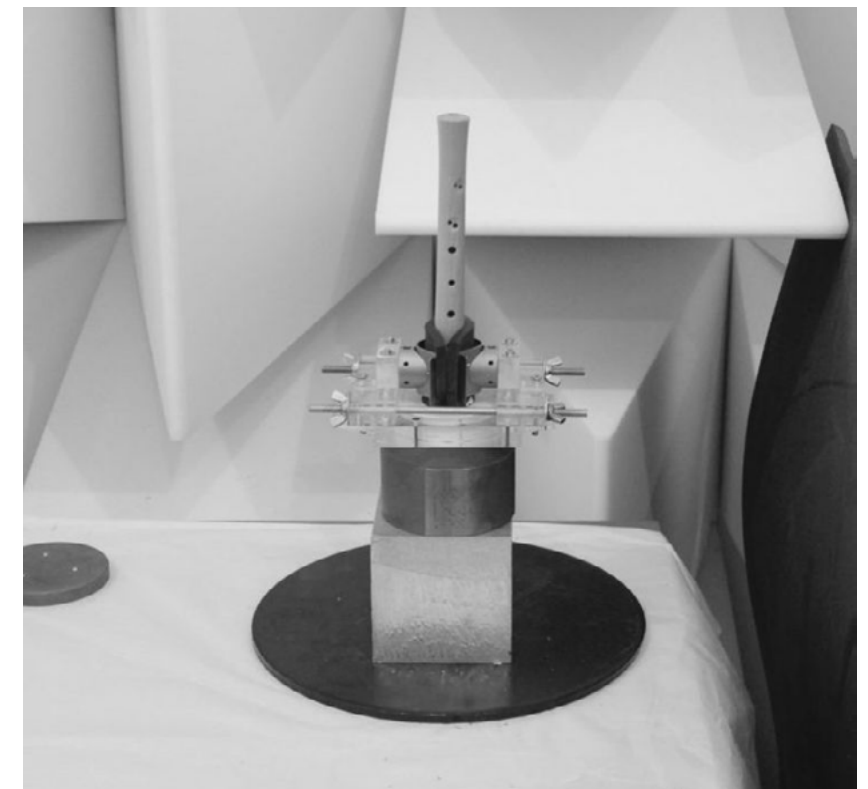

1 F : resonant frequency; C : sound speed (340m/s); L : length of the tube (from the beginning of the tube up to the first open hole); n : 1, 2, 3, etc.

Fig.7 Placement of the instrument on the sensor.

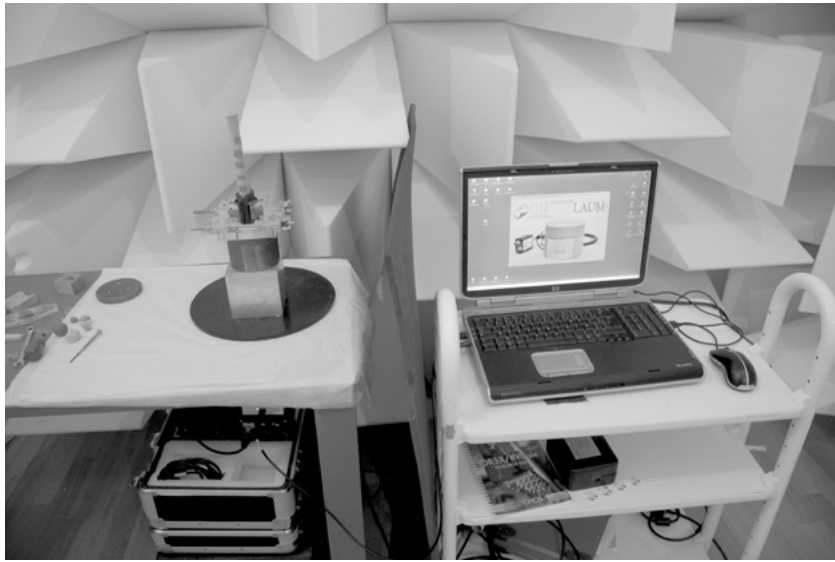
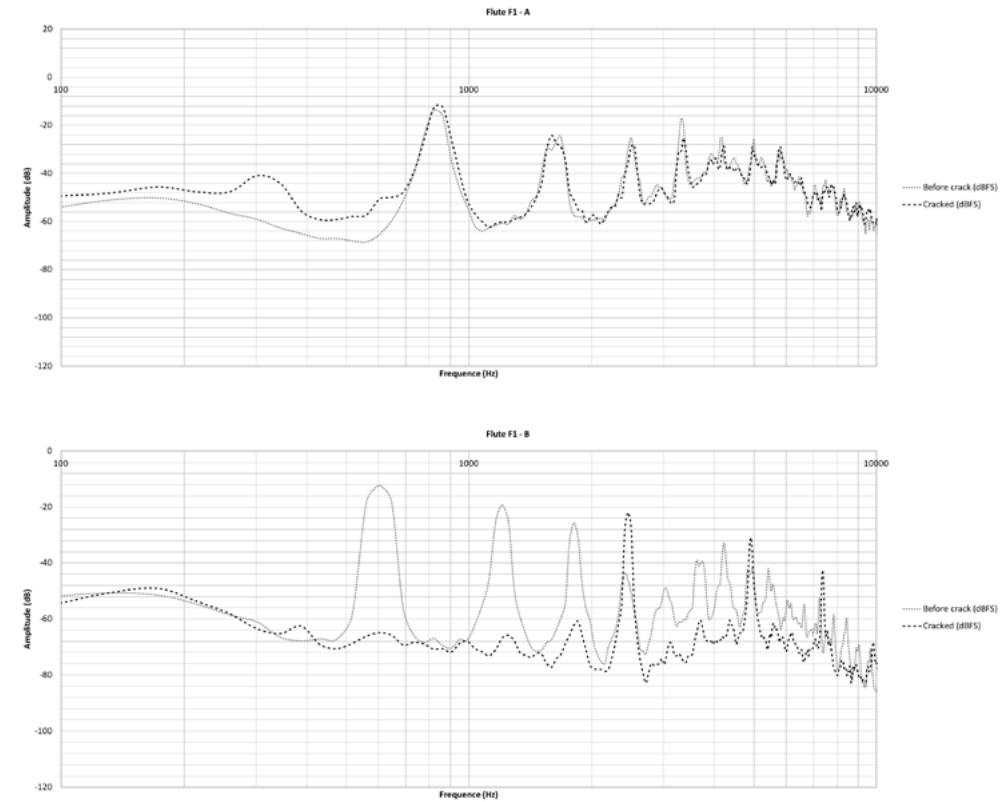
Fig.8**Fig.9****Fig.9**

Flute F1 sound spectra, before and after the artificial crack at the 1st octave with 3 closed holes (A) and with 6 closed holes (B).

3. Results and Discussion

3.1. Recording of the Sound and Analysis with Fast Fourier Transform

3.1.1. The impact of the crack on sound

Regarding the sound spectra recorded on the first octave, 2nd and 3rd fingering position, no major differences were observed before and after the artificial crack [Fig.9(a)]. This is probably because the air exits from the holes of the flute that were positioned after the 3rd hole—including the crack. In contrast, the 4th, 5th and 6th fingering position revealed alterations of the sound spectrum [Fig.9(b)] where it is shown that the first peak of the spectrum has shifted higher (approximately 3000 Hz) whereas its amplitude has decreased. On the second octave, the spectrum responds in the same way as on the first octave.

Fig.8 Experiment setup.

3.1.2. The impact of the repair on sound

Comparing the initial sound spectrum of each flute (before the crack) with the final sound spectrum (after the restoration), the impact of each adhesive on sound can be evaluated. In **Fig.10** to **14**, it is observable that the sound spectrum depending on the restoration material has been shifted from ~20 to ~200 Hz from its initial position. This could signify that the flutes, in some cases have eventually lost their tone. Furthermore, the sound spectra acquired, presented different peaks indicating that amplitude has been increased or decreased depending the adhesive.

Fig.10

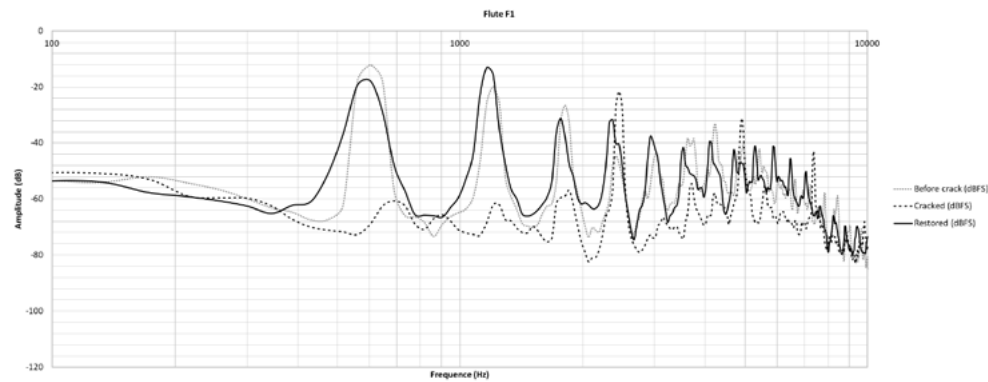

Fig.11

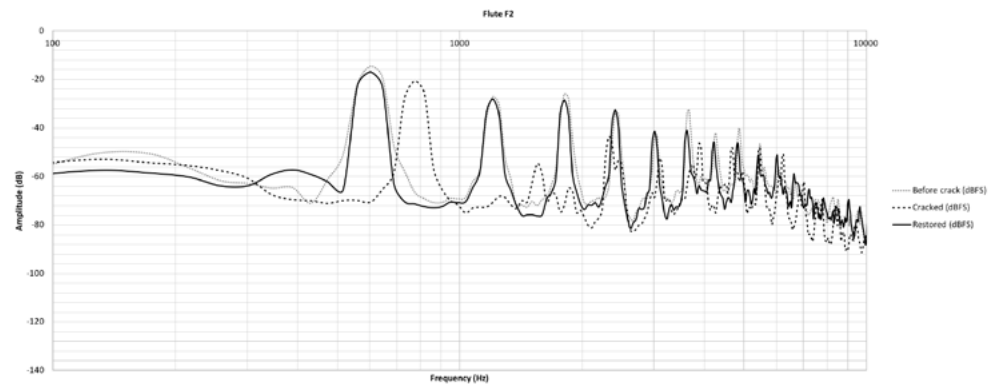

Fig.10 Flute 1 (F1) sound spectra, on the 6th fingering position repaired with epoxy resin. The reference spectrum is plotted against the damaged flute spectrum and the restored flute spectrum.

Fig.11 Flute 2 (F2) sound spectra, on the 6th fingering position repaired with Ravemul M18 Vinavil. The reference spectrum is plotted against the damaged flute spectrum and the restored flute spectrum.

Fig.12

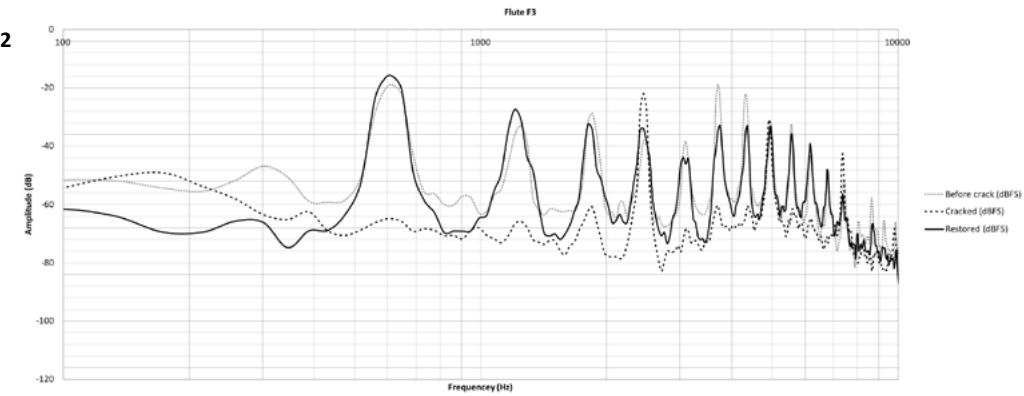

Fig.13

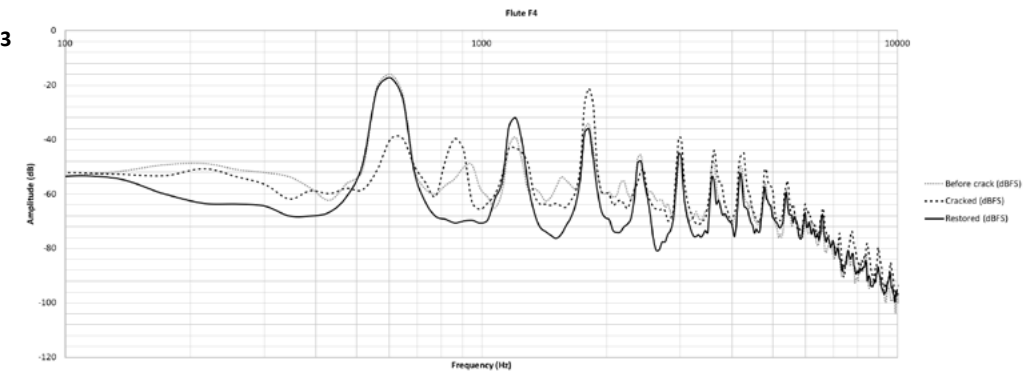
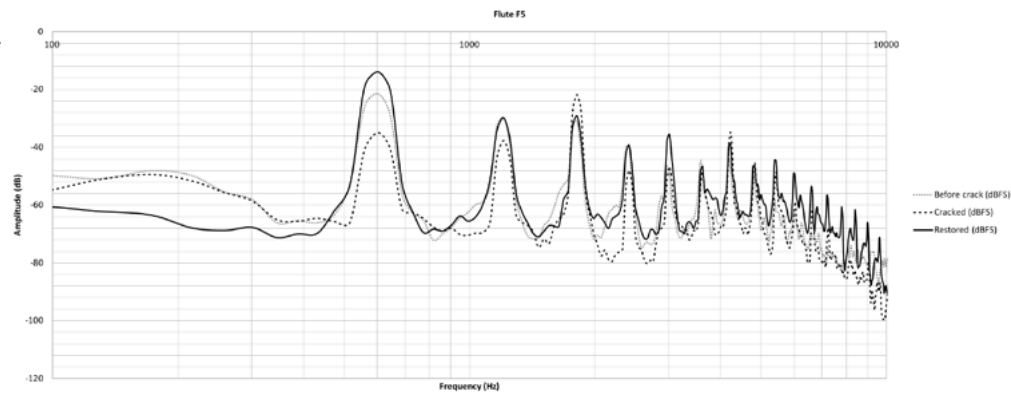

Fig.12 Flute 3 (F3) sound spectra, on the 6th fingering position repaired with fish glue. The reference spectrum is plotted against the damaged flute spectrum and the restored flute spectrum.

Fig.13 Flute 4 (F4) sound spectra, on the 6th fingering position repaired with Lascaux adhesive wax. The reference spectrum is plotted against the damaged flute spectrum and the restored flute spectrum.

Fig.14



3.2. Input Acoustic Impedance Results

3.2.1. The impact of the crack on sound

Comparing the spectra before and after the development of the artificial crack, it is observed that the recorder's crack spectrum has shifted more than 100 Hz to higher frequencies, meaning a change in the flute's tone [Fig.15].

Fig.15

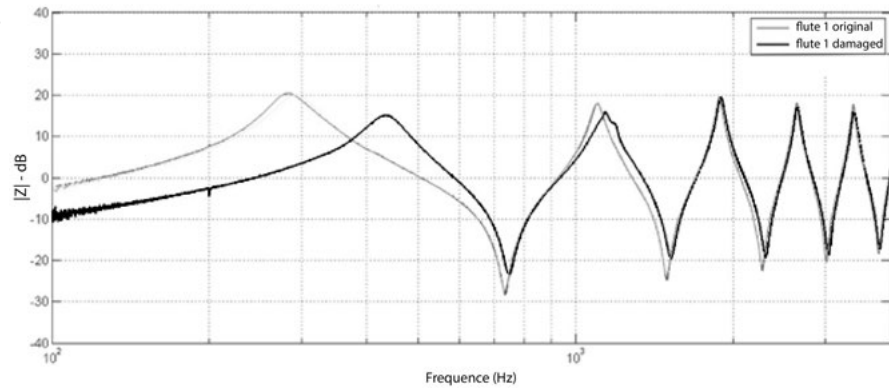

Fig.14 Flute 5 (F5) sound spectra, on the 6th fingering position repaired with Paraloid-B72. The reference spectrum is plotted against the damaged flute spectrum and the restored flute spectrum.

Fig.15 Input acoustic impedance spectrum for recorder 1, before and after the crack.

3.2.2. The impact of the repair on sound

The impact of the repair on sound is shown in Fig.16 to 19. The recorder treated with the synthetic wax presented almost the same peaks and followed the same frequency as the initial spectrum [Fig.16]. The recorder repaired with the fish glue [Fig.17] has approximately the same peaks as the original but its frequency has shifted right. In contrast, the spectrum of the recorder repaired with Paraloid B72 [Fig.18] has shifted some Hertz to the left, but its peaks remained the same. The recorder restored with polyvinyl acetate glue [Fig.19] has not returned to its initial state after the restoration as both amplitude and frequency have shifted.

Fig.16

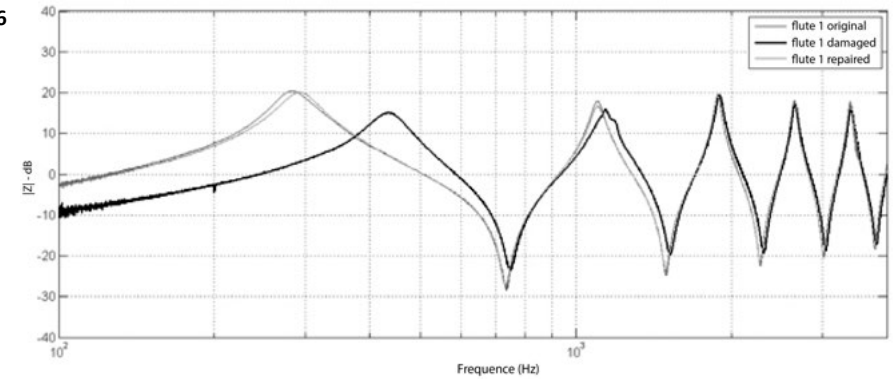

Fig.17

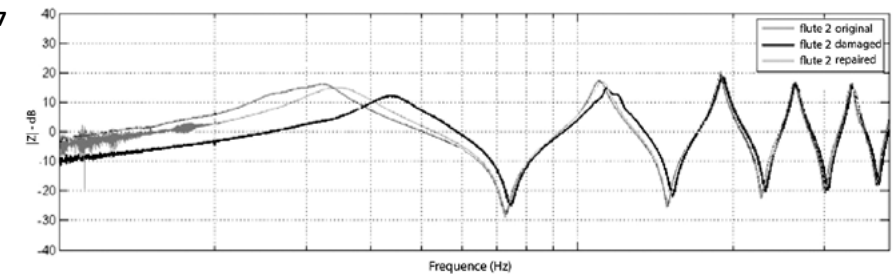

Fig.16 Input acoustic impedance spectrum for recorder restored with Lascaux adhesive wax.

Fig.17 Input acoustic impedance spectrum for recorder restored with fish glue.

Fig.18

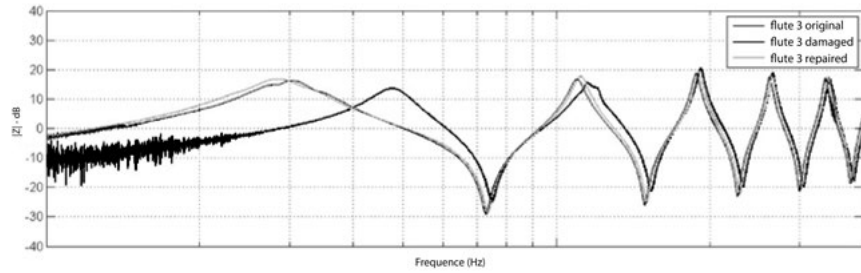

Fig.19

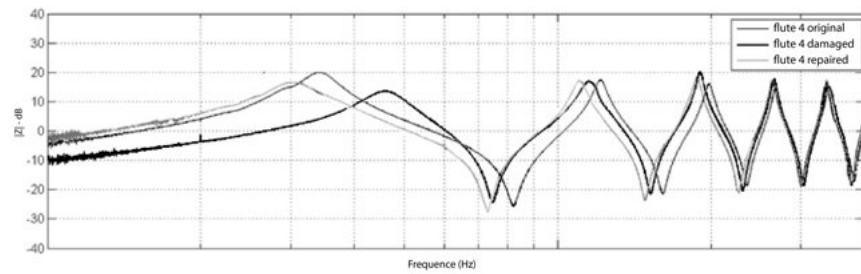

Fig.18 Input acoustic impedance spectrum for recorder restored with Paraloid B72.
Fig.19 Input acoustic impedance spectrum for recorder restored with Ravemul M18.

4. Conclusions

Results obtained by both input acoustic impedance and the spectral analysis of radiated sound showed that the most appropriate conservation material was the synthetic adhesive wax, followed by Paraloid B-72. However, further research is considered necessary to test the behaviour of the adhesive wax in playing conditions over time.

Input acoustic impedance compared to spectral analysis of radiated sound appears to be a more appropriate method for assessing the impact of conservation materials on the sound of historic instruments. It is more representative for the post-conservation condition as it evaluates the pressure at the input and in the cavity of the instrument, instead of the nearfield radiated sound pressure. It is a low-cost and easy technique to implement, and above all it does not cause any damage to historic instruments by blowing air that could produce a thermo-hydro gradient.

Finally, it is considered and strongly recommended that conservation materials for woodwind musical instruments should to be assessed before application to evaluate their impact on sound as they may significantly affect the acoustic properties of woodwind musical instruments and thus alter both their tangible and intangible identity.

ACKNOWLEDGEMENTS: The authors wish to thank K. Fotopoulos for his valuable help and support for the FFT, Dr. A. Koutsouris, Assistant Professor at Department of Conservation of Antiquities and Works of Art of the Technological Educational Institution for consultancy on historical instrument conservation, Dr. M. Founti, Professor of National Technical University of Athens (NTUA), for providing the mass flow controller equipment as well as Dr. Ch. Cheramiotis and Dr. I. Mandilaras (NTUA) for their support during the experiments. Finally the authors would like to thank the COST Action FP 1302 WoodMusick for providing the opportunity to implement part of this research.

References

- [1] E.M. von Hornbostel and C. Sachs, "Systematik der Musikinstrumente. Ein Versuch," in *Zeitschrift für Ethnologie*, vol. 46, no.4-5, p.553-590, 1914.
- [2] U. G. K. Wegst, "Wood for sound," *Am. J. of Botany*, vol. 93, no. 10, pp. 1439-1448, 2006. [Online]. Wiley-Blackwell, doi:10.3732 /ajb.93.10.1439.
- [3] M. Zardo, "Guide to the Restoration of Woodwind Instruments," *Early Music*, vol 2, no. 3, 1974, pp. 169-174. [Online] Oxford University Press, doi:10.1093/earlyj/2.3.169.
- [4] G. Tavlaridis, Conservation and Care of Musical Instruments. (n.p.): Filippou Nakas, 2009.
- [5] C. A. Eckelman, "The Shrinking and Swelling of Wood and its Effect on Furniture," *Forest Natural Resources*, No. 163, pp. 26., 1998. [Online]. Available: <https://www.extension.purdue.edu/extmedia/FNR/FNR-163.pdf>. Accessed on: March 1, 2018.
- [6] E. C. Peck, *How Wood Shrinks and Swells*. Madison, WI: U.S. Dept. of Agriculture, Forest Service, Forest Products Laboratory, pp. 235-244, 1957.
- [7] *Shrinking and Swelling of Wood in Use*. Madison, WI: U.S. Dept. of Agriculture, Forest Service, Forest Products Laboratory, 1957.
- [8] F. J. Lewis, *The Care, Repair, and Selection of Musical Instruments for the Instrumental Music Teacher*. Los Angeles, CA: Music University of Southern California, 1956.
- [9] P. Eveno, and S. Le Conte. "An Acoustical Measurement Used for the Understanding of Historical Wind Instruments," *J. of Cultural Heritage*, vol. 20, 2016, pp. 615-621. [Online] Elsevier BV, doi:10.1016 /j.culher.2016.02.005.

Revisiting the Notion of “Resonance Wood” Choice: A Decompartmentalised Approach, from Violin-Makers’ Opinion and Perception to Characterization of Material Properties’ Variability

C. CARLIER (1), A. ALKADRI (1),
J. GRIL (1),(2), AND I. BRÉMAUD (1)

(1) Wood Team, Laboratory of Mechanics and Civil Engineering, CNRS,
UMR 5508, University de Montpellier, France

(2) Institut Pascal, CNRS, UMR 6602, Université Clermont Auvergne, France

Abstract

This work aims to improve our understanding of the resonance wood and to investigate the interactions between their physical-mechanical properties, natural variability, and the violin-makers’ ways of choosing their materials. In order to identify luthiers’ practices and opinions, a socio-technical survey was conducted. Physical, vibrational, and visual/structural characteristics of the resonance wood obtained from several provenances with a variety of quality grades were also determined. Finally, these two approaches were completed by a psychosensory evaluation to compare the measurements that we have conducted with the perception and qualification of wood by the violin-makers.

1. Introduction

Woods, as the main constitutive materials of many musical instruments, play an essential role in defining their “identity”. The choice of wood by instrument-makers is, therefore, a central question. It is intricately linked with the flora available (local or imported), cultural aspects of both woodworking craftsmanship and aesthetics (musical and visual), as well as physical behaviour and the acoustic response resulting from the material-structure-excitation system. This means that the study of instrument-making wood is intrinsically linked to the notion of diversity, whether biological, cultural, functional or physical diversity, or all of these together. It also means that various different disciplines, often very distantly related to each other, may be involved in the study of wood choice by instrument-makers. However, most existing research usually adopts a single or limited number of viewpoints.

In some of our previous work, we aimed at relating biological and cultural diversity together with material physical/acoustical properties, in order to understand wood choice through different geocultural areas (for tuned idiophones’ bodies or for chordophones’ soundboards [1]), or through centuries (for European bows [2]). However, when one tries to consider jointly all the above-cited types of diversity together, some information is often missing, from at least one of the involved disciplines or viewpoints. Especially, it seems that extra-European instrument-making cultures have benefited from less academic research than Western ones did, and early-music (or traditional) instrument-making less than Classical or modern ones. Direct interaction with instrument-makers from the various cultures is also more difficult (or even impossible for past cultures). Similarly, tropical, Mediterranean, or even temperate but “secondary” forest species have benefited from much less physical characterisation of their woods than did more common temperate hardwoods and especially softwoods. Therefore, in order to better understand the concept of “choice of wood by instrument-makers”, with enough precision and information within and between the different fields involved, it may be useful to focus and reduce the object of study while keeping the variety of viewpoints [3]. It is then necessary to select a case study which is sufficiently documented in different disciplines, in order to serve as a model for a decompartmentalised approach.

Among the many instrument-making woods or tonewoods around the world, the term “resonance woods” usually refers to those employed in the making of the violin family [4, 5, 6, 7]. The choice is nearly exclusive to spruce (usually *Picea abies*) for the soundboard and to maple (usually *Acer pseudoplatanus*) for the back and sides. Due to the cultural importance and the “prestige” of the violin in Western classical/academic music, the instruments themselves, and the woods used for mak-

ing them, have been the subject of extensive research, in organology/musicology, acoustics, and forestry/wood science, much more than any other type of instrument-wood association. As an example, the sole *Picea* genus (spruce) is described by a number of tests for vibrational properties that is as big as the total number of such tests for all species (several tens of thousands) from tropical forests... [8]. And yet, the actual span and different scales of variability within spruce resonance wood have still not been completely assessed. There are also several technical treatises of violin-making from the two past centuries which describe some criteria for choosing wood [7, 9]. Most importantly, violin-making encompasses a wide and vivid community of active luthiers, and, so it seems, a quite strong transmission of craftsmanship knowledge with little discontinuities can be observed. Therefore, the violin-makers’ choice for resonance wood would give us a good model for studying the different facets involved in the choice of wood for musical instrument-making. However, most research has remained quite compartmentalized, with little integration between information from different disciplines, and even less so between scientific and craftsmanship knowledge. In addition, a possible pitfall to watch for within this subject is that the prestige of the violin has generated a certain number of myths conveyed to the general public [10]. This is outside the subject of our work, but it suggests that resonance wood selection merits study with a pair of fresh eyes.

The general objective of this research is therefore to revisit the concept of “resonance wood choice” by taking jointly into account the opinion and practice of violin-makers, the characterisation of physical-mechanical properties according to several scales of wood variability, and the sensory perception by makers in order to determine the relationships between the craftsmanship experience and the quantifiable properties of wood.

2. A Survey to Grasp Luthiers’ Opinions, Practices and Craftsmanship Knowledge on Wood

Although some aspects of wood choice by violin-makers are written in early technical treatises and reviews [7, 9], very little formal research has been conducted recently to grasp the opinion of contemporary instrument-makers. One of the rare examples of a recent survey with violin-makers, in the field of anthropology of techniques, examines the learning process and the transmission of the knowledge of the trade [11], but it seems that the knowledge of the wood itself was not specifically addressed in such surveys.

To improve our knowledge of violin-makers practices and their main issues and opinions about wood, we created a specific survey [9,

12, 13]. The questionnaire was first designed for face-to-face interviews, following a modular structure, and then put online. It contains nine sections organized as follows:

- a. profile of the interviewee
- b. concept of the 'quality' of an instrument
- c. supply & wood choice in general
- d. evaluation of wood for top plates
- e. evaluation of wood for back plates
- f. evaluation of wood for bows
- g. aging, treatments and varnishes
- h. link to scientific and historical research
- i. questions, feedback and comments.

The objective is to capture how luthiers consider the role of wood in the quality of violin and their procedure for obtaining wood supplies, as well as to categorize the different criteria they rely on for the selection of wood blanks.

The analysis of the survey is currently based on 15 complete responses of makers of the bowed-strings family. All of the participating craftsmen are French and produce string quartet instruments (violin, viola and cello, with less than one fourth working on double-bass). Two of them are also luthier-bow makers, and another two also build early-music instruments (viola da gambas or early bows). Almost all of them are independent craftsmen. The majority (64%) of the makers work alone in their workshop. The average age of respondents is 46 years. Thus, the panel's experience distribution between the classes (less than 4 to 37 years) is balanced, with a majority having more than 15 years' experience. The panel of respondent luthiers are primarily engaged in the construction of new instruments (60% of their time, on average).

The approaches that luthiers reckon to use during their work are "principally" or "often" (85%) empirical (know-how and technical knowledge) followed by historical (70% "often") but scientific approaches are only "moderately" or "little" (79%) used in daily work. Meanwhile, most of these makers reported a lot of interest for scientific research on instruments (76%) and/or on tonewood (83%). Individual makers show various "profiles" of interest between several fields of academic research (humanities and arts, natural or physical sciences), and many of them (70%) consider that they conduct research in their workshop.

According to the luthiers interviewed, the choice of wood for top and back plates ranks within the top most important making parameters that determine the quality of an instrument. For "overall quality", they consider the wood for back plate to rank first (100% "very important" or "important") followed by varnish and wood for top plate (93% each).

For "sound quality", too, the choice of wood for the back comes first, tied with fine adjustments (100% "important/very important"), and the wood for the top plate comes second (93%), that is, even before important structural making parameters such as design, geometry and pre-stresses (86% each).

Most of the makers (80%) buy the wood for top and back-plates from specialized suppliers of tonewood. They generally acknowledge their suppliers' expertise and thus trust in their work and preselection of wood. While the luthiers are interested in the forest dimension, they do not consider themselves competent enough and/or do not have time to delve more deeply into it. This was confirmed by an interview with a supplier, who stated that makers are not interested enough to go to the forest. Some of the makers have also evoked the image of luthiers prospecting wood directly in the forest as a myth, but one that they take pleasure in maintaining.

The two most important criteria in the purchase of wood supplies by luthiers are the quality followed by price. The provenance and the drying time of the offered stocks have only secondary impact on the choice of suppliers, but the traceability of their stock has also sometimes emerged spontaneously. Moreover, suppliers also evoke an increase in makers' expectations. Previously, suppliers only proposed two categories of wood blanks to the makers based on their quality (one priced at €30, the other at €50). However, nowadays they have to offer a wider range of products with prices ranging from €10 to €300. For spruce wood used for top plates, three main provenances were mentioned by the makers: Italy ("Val di Fiemme", "Italian Alps", "Italian Dolomites"), Switzerland ("Tyrol", "Swiss Alps") and France ("Jura", "French Alps"). This is consistent with the spruce tonewood repartition area but does not cover all the known provenances of such wood. French makers mainly focus on the historical cradle of violin-making and on the West part of tonewood repartition area, the nearest to them. For maple, the stated degree of precision for provenance varies greatly (from "indifferent" or "Europe" to specific countries), with "the Balkans" being the most cited.

When choosing wood from the stock of a given supplier, interviewed makers rely mostly on their experience, on a "feeling acquired by practice" for evaluating wood quality, and only very little on "rules from training or books" or "measuring tools". To guide their selection of wood pieces, they mostly use their personal evaluation of visual features (83% "very important" + 17% "important") and weight/density (75% "very important" + 25% "important"), while hand testing of acoustic features like "tap-tone" is stated as "important" (42%), but less strongly relied on (only 42% "very important"). Their choice is based very little on measuring tools (only 17% "important") or quality grades attributed by suppliers (only 17% "important").

Concerning the choice of individual wood blanks (wedge shaped boards) for top plates, the selection criteria for spruce are mainly based, by order of stated importance, on the cutting plan/orientation (importance score 9.7/10), density (8.8), growth-ring uniformity (8.3) and width (8.0), percentage of latewood (8.3), and hardness (8.0). All other stated criteria, including “tap-tone”, get importance scores lower than 7.0/10. For maple wood for back plates, the cutting plan also appears to be the most important criteria (8.5/10), followed by growth-ring width (8.0) and density (7.6), medular rays (7.1), and then figure (6.9). The cutting plan evaluation for both the top and back plates is considered as “very important” or “important”, which might suggest a good perception of the mechanical performance of wood by the makers, since a minor change of grain angle is enough to greatly affect vibrational properties [14]. Most of the luthier’s panel admit that they have changed over time, at least slightly, their criteria for choosing a wood blank.

3. Material Properties and Natural Variability of Resonance Woods

3.1 Characterisation of the Physical, Mechanical, Acoustical and Structural Properties

A wide sampling of wood sold for violin plate blanks (wedge shaped boards) was collected from different suppliers and provenances, with varying quality grades. Regarding the spruce, 49 top plates were gathered from three different provenances (France, Italy, Switzerland) and four quality grades (from the lowest, D, to the highest, A, quality grade). The selection of top plate blanks was not meant to be representative of a supplier’s stock but, instead, to represent the maximum variability that could be offered. Similarly for maple, 24 blanks for back plates and sides were procured from four quality grades established by the suppliers, aiming to take into account the highest variability. One of the main selection criteria was the variety of wavy grain figures.

The sampling plan and specimen cutting protocol [Fig.1] aims at improving the knowledge of the multi-level variability of resonance wood properties, jointly with a study of makers’ perceptive evaluation (see section 4). Compared to most other existing studies, here we also included an additional variability factor: the local variations of properties within a given wood blank. A thin board (2.5 mm in thickness) was extracted during the separation of the quarter cut blank wedge into two halves of the future top (soundboard) or back plate. These thin boards, representative of the initial violin-making blank wedges, were used for laboratory testing, while the remaining wedge blanks were kept for the psychosensory evaluation. Radial (R) and longitudinal (L) specimens were cut from the thin boards to assess the properties of the wood and their variations in those two directions. From each thin board, one to

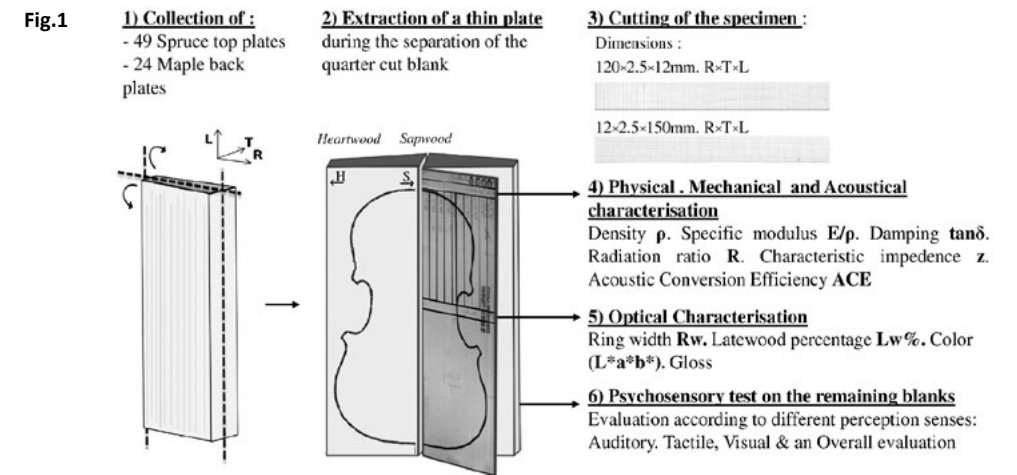

three radial specimens with the dimension of 120 mm × 2.5 mm × 12 mm ($R \times T \times L$) and seven to ten longitudinal specimens with the dimension of 12 mm × 2.5 mm × 150 mm ($R \times T \times L$) were obtained. They were conditioned at 20 ± 1 °C and $65 \pm 2\%$ RH for at least 3 weeks to reach the standard air-dry equilibrium moisture content ($\sim 12\%$). These specimens were characterized for their physical and vibrational properties (density ρ , specific modulus of elasticity E'/ρ , damping coefficient $\tan\delta$, in R and L direction, and also shear properties G_{LT} and $\tan\delta_{GLT}$ on a sub-sampling), and their optical/structural traits (ring width Rw , latewood percentage $Lw\%$, colorimetry, gloss) as described in [9]. Then some acoustic “performance indexes” described in [1, 15–17] were calculated (radiation ratio $R = c/\rho$, characteristic impedance $z = \rho E$, acoustic conversion efficiency $ACE = R/\tan\delta$ and loudness index $L = R_L R_R / \delta_L \delta_R$).

The summary of all measured properties of spruce and maple resonance wood (calculated by averaging values of the different specimens cut from a given plate) is provided in **Table 1**. The values of the measured properties are consistent with other studies [4, 5, 6, 16, 17, 18], even if sometimes the ranges of variation that we observe are higher, as a result of our wide sampling.

Fig.1 General sampling plan, specimen’s cutting and test protocol.

Table 1

		Spruce						
		Min	Max	Av.	S. Er.	Rov (%)	Cov (%)	Nb
Mechanical vibrational properties	ρ	0.32	0.55	0.42	0.06	56	13	49
	E_L / ρ	18.5	35.9	29.7	3.3	59	11	49
	E_R / ρ	1.2	3.4	2.3	0.4	95	18	49
	$\tan\delta_L$	0.006	0.010	0.007	0.001	53	11	49
	$\tan\delta_R$	0.017	0.036	0.022	0.004	90	19	49
	E_L	6.3	17.0	12.4	2.6	87	21	49
	E_R	0.5	1.4	0.9	0.2	90	21	49
	G_{TL}	0.70	1.22	0.93	0.16	55	17	9
	$\tan\delta_{GTL}$	0.016	0.020	0.018	0.001	17	6	9
Acoustical indexes	z_L	1.5	3.1	2.3	0.4	71	17	49
	z_R	0.4	0.8	0.6	0.1	64	15	49
	R_L	9.7	16.6	13.3	1.5	52	12	49
	R_R	2.3	5.5	3.7	0.6	88	17	49
	ACE_L	1241	2628	1938	320	72	16	49
	ACE_R	92	277	178	45	104	25	49
	L	16505	71047	35300	12356	155	35	49
Optical features	Rw	0.77	2.52	1.48	0.37	118	25	45
	Lw %	0.13	0.26	0.18	0.03	77	16	45

		Maple						
		Min	Max	Av.	S. Er.	Rov (%)	Cov (%)	Nb
Mechanical vibrational properties	ρ	0.5	0.7	0.6	0.0	25	7	24
	E_L / ρ	11.1	20.7	15.3	2.7	63	18	24
	E_R / ρ	1.9	3.1	2.7	0.3	45	11	24
	$\tan\delta_L$	0.01	0.01	0.01	0.00	53	16	24
	$\tan\delta_R$	0.02	0.03	0.02	0.00	21	6	24
	E_L	6.7	13.8	9.8	1.8	73	19	24
	E_R	1.2	2.1	1.7	0.2	51	13	24
	G_{TL}	1.2	1.6	1.4	0.1	27	8	8
	$\tan\delta_{GTL}$	0.017	0.028	0.021	0.003	53	15	8
Acoustical indexes	z_L	2.2	4.5	3.4	0.7	68	20	24
	z_R	0.8	1.7	1.3	0.3	68	22	24
	R_L	4.8	7.6	6.1	0.7	45	12	24
	R_R	2.1	3.2	2.6	0.2	40	10	24
	ACE_L	352	870	598	148	87	25	24
	ACE_R	83	153	116	16	60	14	24
	L	3458	12498	7095	2460	127	35	24
Optical features	Rw	-	-	-	-	-	-	-
	Lw %	-	-	-	-	-	-	-

Table 1 Summary of characterizations at the blank plates' level of spruce and maple resonance wood. Av: Average; S.Er: Standard error; Rov: Range of variation; COV: Coefficient of variation; Nb: Number of Top or Back plates; L: Longitudinal direction; R: radial direction; T Tangential direction.

In spruce, we notably observe a large range of density ρ (0.32 to 0.55), specific modulus of elasticity in the longitudinal direction E'_L/ρ (18 to 35 GPa), longitudinal damping factor $\tan\delta_L$ (0.006 to 0.100), ring width Rw (0.77 to 2.52 mm) and latewood percentage $Lw\%$ (13 to 26%). The expected properties for spruce, such as low damping coefficient ($\tan\delta$), low characteristic impedance (z), high axial specific modulus (E'_L/ρ) and high radiation ratio (R) were considered together with the role of the top-plate soundboard in the instrument (for instance, the higher the radiation ratio is, the greater the vibration amplitude and radiation will be).

Regarding maple wood for back plate, its range of variation (Rov) of the properties appears to be lower than the spruce's, which is probably due to, partly at least, the lower number of boards studied, for the coefficients of variation (Cov) are of comparable amplitude for the 2 species. As expected, maple specimens possess higher density, damping and characteristic impedance, while having lower specific modulus, radiation ratio and ACE than spruce. The measured properties of spruce and maple present specificities adapted to their role in the instrument making [15, 17, 19]. Some current studies have taken into account these differences in wood properties in the modelisation of violins in order to quantify the respective impact of various wood parameters on the vibroacoustic response of the instrument [20].

3.2. Natural Variability of Properties Between Different Violin-Making Wood Blanks

In this part, we will focus on spruce since the variability of maple properties was previously analysed in regards to its anatomical features in our recent paper [21]. Our general objective is to evaluate the variability of physical and acoustical properties of tonewood in relation to qualities for use. **Fig.2** shows, for a given property, the differences between quality grades and whether or not they are significant using the Multiple Comparison test. We observed that the differences

Fig.2

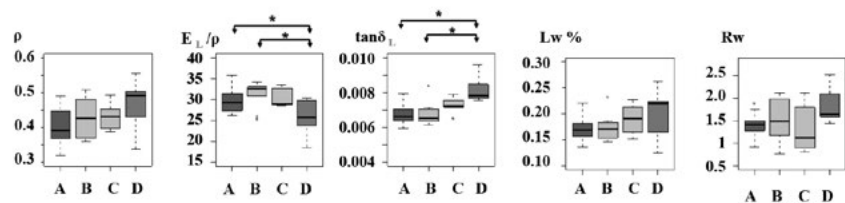

Fig.2

Distribution of some physical-mechanical properties and optical features of resonance spruce plates according to different quality grades (A=highest, D=lowest): the significance of differences between grades is indicated by a star (*).

between the first and second quality grades were not significant, whereas significant differences were found on the fourth quality grade, which clearly differs from other grades. However, even without statistically significant differences between suppliers, clear trends can be observed among the four quality grades: with the increase in quality grade, we found lower density (ρ), higher specific modulus (E'_L/ρ), lower damping ($\tan\delta_L$), and lower latewood percentage ($Lw, \%$) and ring width (Rw) within the resonance wood. Those observations are consistent with current makers' selection criteria and previous research, which, however, included fewer quality grades [18].

It is also interesting to compare those results with the survey: although makers claimed their trust in their supplier's expertise, they also said that they paid little attention to supplier grades. We could explain this paradox with the following assumption: suppliers sort resonance woods mostly on cutting, optical, and density criteria, which seems to also lead to a mechanical and acoustical sorting. However, the distribution of properties within each grade shows that it is indeed possible to find adequate resonance wood in other grades than the first one. Considering the fact that the quality grades also affect the prices, one can propose a hypothesis that the makers' behaviour on quality grades attributed by suppliers, is mostly guided by economic reasons.

To complete our understanding of the variability between different wood blanks, the correlation between optical-structural characteristics (latewood percentage and ring width) and physical-mechanical properties or acoustical indexes is represented according to wood provenance and quality grade in **Fig.3**. Latewood percentage highly correlates with wood density (ρ) and acoustical indexes such as radiation ratio (R) and impedance (z) in both longitudinal and radial directions for the three provenances and the four quality grades. Concerning ring width (Rw), its correlations with other properties is weaker; however, ring width seems to be a good indicator of specific modulus (E'_L/ρ) in the longitudinal direction. This last result, obtained from spruce specimens that have been pre-selected as resonance wood, is interesting because such a correlation barely exists in general supply (non-selected wood) or faster grown trees of the same species [22].

However, there are clear differences in these correlations depending on provenance. For example, while it seems that the ring width of the wood samples from Italy do not share any relationships with any properties for wood samples from France and Switzerland, the ring width correlates with longitudinal specific modulus, damping, and anisotropic ratios. Further, the relationships between latewood and specific modulus also differ according to each provenance. As an example, the correlation is highly significant for top plates from Switzerland but non-existent for those from France.

Fig.3

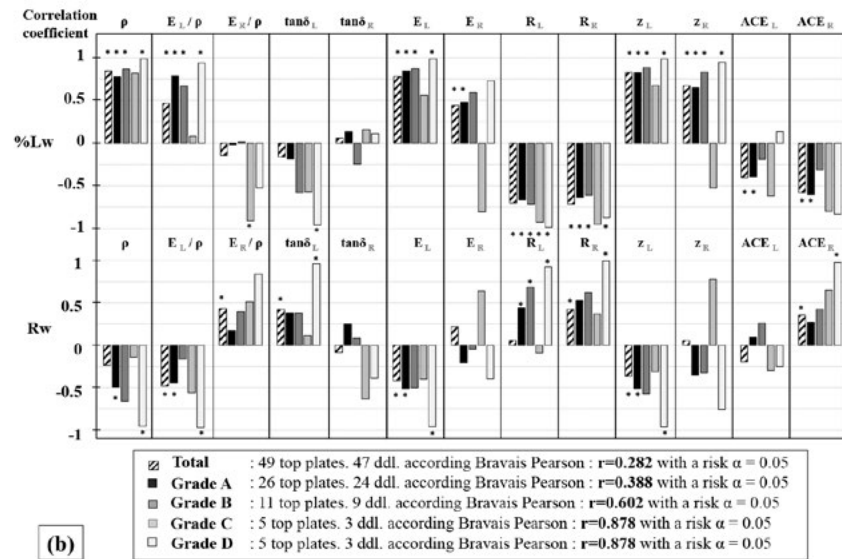
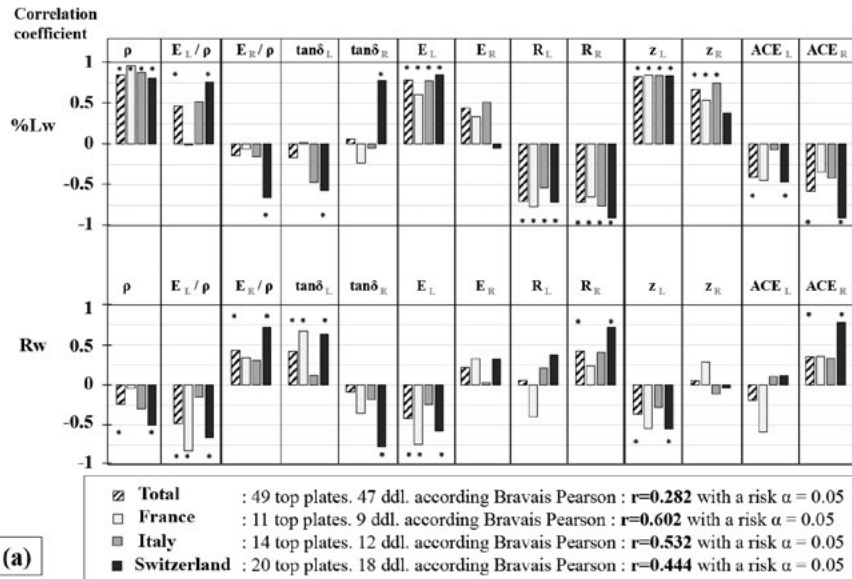

Fig.3 Correlations between visual features and mechanical and acoustical properties according to top plate provenance (a) and quality grade (b). The significance of correlations is indicated by a star (*).

To sum up, instrument makers' criteria for visual evaluation seem to give us an idea of some of the physical/acoustical properties of wood, even if those relations are not always equal for every provenance and quality grade of the wood.

3.3. Variations within individual blank wedges of resonance spruce

Within-plate variations of wood properties, corresponding to different radial positions, are shown in **Table 2**. Although the mean level of variability (ROV or COV) is smaller within one plate than between different plates (**Table 1**), the maximum coefficient of variations behaves differently. Within-plate variation is equivalent to between-plate variation for longitudinal specific modulus (11% in both cases) and even significantly higher for latewood (28% vs. 16%) and ring width (39% vs. 25%). For some properties, a higher variability can be observed within some given plates than between the different plates. These results suggest that, in resonance wood study, intra-plate variations must be considered almost at the same level as the inter-plate variations, even if the amplitude depends on the studied plate.

Table 2

		Rov	Cov
ρ	Average	11%	4%
	Min	3%	1%
	Max	24%	7%
E_L/ρ	Average	13%	4%
	Min	4%	2%
	Max	34%	11%
$\tan\delta_L$	Average	14%	5%
	Min	4%	1%
	Max	26%	11%
Rw	Average	63%	20%
	Min	27%	8%
	Max	110%	39%
Lw %	Average	32%	10%
	Min	11%	4%
	Max	96%	28%

Table 2 Variation within one spruce top plate of wood properties and optical features. Rov: Range of variation = (max-min)/average; Cov: Coefficient of variation = standard deviation/average.

Fig.4

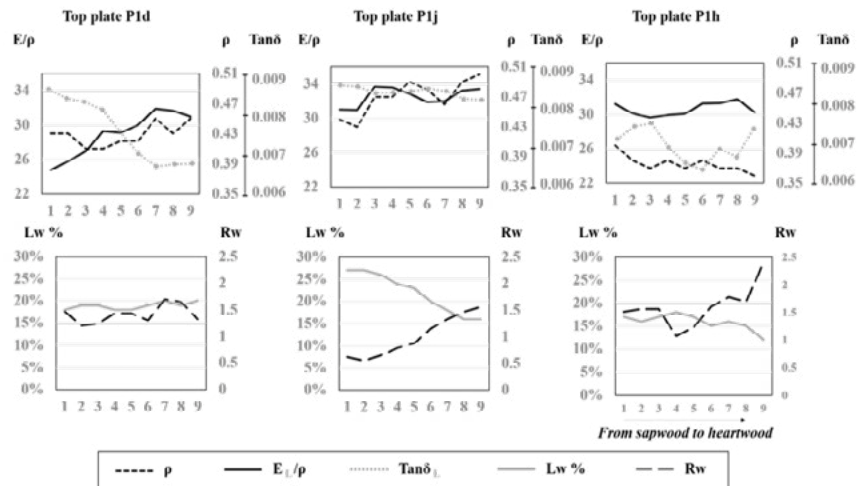

Fig.4 gives the radial variation of the main properties and characteristics: density (ρ), specific modulus (E_L'/ρ), damping ($\tan\delta_L$), ring width (Rw), and latewood percentage (Lw, %). They are shown from outerwood (closer to sapwood) to innerwood (towards centre of the tree), corresponding to the center and the side, respectively, of the top plate of a musical instrument such as a violin. From the center to the side (of a future soundboard), different trends are observed according to the property: generally an increase of specific modulus and ring width, and a decrease in density, damping and latewood percentage. However, the existence of marked heterogeneity, both concerning the profile and the amplitude of variations, can be noted depending on the wood plate.

During the survey, some makers indicated a preference for resonance spruce with thinner rings in the center of the instrument (0.8 to 1.5 mm) and wider rings in the sides (2.0 to 2.5 mm). From our previous observation, one can wonder: what is the impact of the selection criteria based on ring width on the material properties? The intra-plate variability has to be taken into account since the overall characterisation of the board does not provide enough information on wood properties and their variations, and one unique sample from the board may not be representative of the top plate properties.

Fig.4

Representation of the intra-plate variability of some wood properties and optical features. The top plates presented here (P1d, P1j, P1h) belong to top quality grade A.

4. Sensory Perception of Resonance Spruce

In the previous sections, we studied tonewood selection from several viewpoints, but there was no direct confrontation between the makers, the material, and its measured variability. In this part of our work, we aim to understand the direct interactions between the craftsmen and their wood through a psycho-sensory evaluation. There are few studies on the sensory perception of wood by instrument-makers (e.g., [23]), with, to our knowledge, only one focusing on violin-making resonance wood [6], while it is suggested that trade-speciality strongly impacts wood perception [24].

As the perceptual criteria used for wood evaluation can be primarily based on the tactile, visual and auditory sensory modes, we thus designed the test in four parts. The three first parts of the test were created to evaluate, separately, the respective contributions of the different perceptual modes. The final part of the test was an overall evaluation, aiming to reproduce, as closely as possible, the habits of luthiers in their workshop. Except for the last part, each protocol follows the same outline. First, some attributes are evaluated to establish a sensory profile of the wood blank according to each sense. This part allows us to characterize the product and to learn how the attributes may define a board's quality as excellent or unusable. The blanks were then evaluated with a general quality rating for each sense. Finally, an acceptance test was performed to determine the emotional attachment to the product.

In the first part of the protocol, the resonance woods were evaluated through hearing only. Makers were asked to evaluate several attributes such as “pitch”, “sound duration”, and “crystallinity”. In the second part, the sense of touch was tested. The makers were asked to evaluate the top or back plates by touching the surface of the material only, then by weighing it. Makers had to evaluate the “roughness”, “hardness”, and “density” of the material. The third part focused on vision. The panel observed the samples without touching them. The selected attributes were, for spruce top plates, “ring width” and “regularity”, “latewood percentage”, “cutting plan”, “colour”, “gloss”, and “hazelnrowth” (indented rings). Finally, the overall evaluation was conducted by letting makers use all their senses, as they would usually do in their workshop. This overall evaluation included a quality rating, an acceptance test and optionally free verbalisation.

The relative weight of the considered perception senses—used to examine the material's quality—and the attributes favourably perceived by different senses to define a good top plate were determined. The evaluation of the makers was analysed in regard to the physical measurements of the specimen in order to characterize their perception. As the test was time-consuming (ranging from 40 minutes to two hours), the analyses of the psychosensory study on spruce are currently based on seven complete responses only. Therefore, the number of participants is not yet significant.

While observing the evaluation of each wood blank according to the general quality rating for the different perception senses, we observed different kinds of variability interacting with the obtained results. Firstly, the perceived differences between plates differed according to each sense of evaluation: discrimination between different spruce blanks, for instance, was more difficult to access by the auditory rating than through the visual, tactile or overall ratings (**Fig.5**). This variability could be attributed to two causes: (1) the makers could indeed perceive more differences through the tactile, visual or overall senses than by using their auditory senses only (which means that the auditory perception might have less weight than the tactile or visual perception); (2) the perceived differences could be due to a flaw in conception of the protocol (the makers could have felt more confident during the successive steps of the test and thus given more and more adamant evaluation).

Second, we observed variability between different makers' behaviour. We observed diverse quality rating values according to the makers—some makers always gave lower ratings than others—as well as differences in the distribution behaviour—for example, some makers tend to give wider differences in ratings between the various top plates.

To define a “good top plate”, we first isolated the attributes that are favourably perceived by the makers by looking at the correlation between individual attributes and the general quality rating for each sense. Afterwards, we analysed the perceived attributes in relation to the physical measurements that we had previously conducted on the specimen. The results (**Table 3**) show that the auditory quality rating of the wood blanks is mainly correlated to attributes that express the damping (“length/duration of sound” and “crystallinity”), which is consistent with results from the literature [23]. At the same time, according to the correlation with the measured wood properties (**Fig.6**), it also appears that the auditory attribute which the makers perceived most is “pitch”, which is an indication of the resonance frequency or sound wave celerity. For a constant geometry—which is the condition of the material during our test—the higher the “pitch” of the fundamental note, the higher the speed of sound. In short, it is an indicator of the specific modulus of elasticity of the wood. However, on a daily basis, in the real conditions of workshops, the dimensions of the blank wedges for plates are highly varied. Therefore, this parameter (pitch) cannot be taken into account in practice—unlike the damping, which is less linked to geometry. Thus, the behaviour of makers—not taking pitch into account—is adapted to their usual work situation.

Concerning the evaluation of wood through tactile sense, the main attribute to define a “good” wood blank was its density ($R=0.73$ between evaluation of attribute—from “very dense” to “very light”—and the

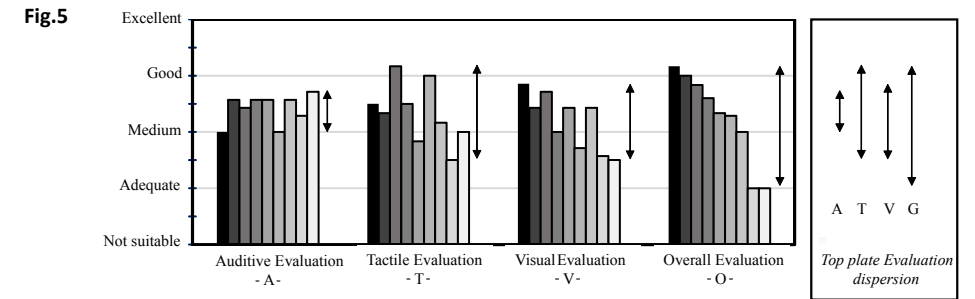

Table 3

Perceived attributes		Correlation to :	
Perceived Pitch	Pitch	-0.04	Auditory rating
Perceived Length	Len.	-0.56	
Perceived Crystallinity	Cry.	0.47	
Perceived Roughness	Rou.	-0.10	Tactile rating
Perceived Hardness	Hard.	-0.30	
Perceived Density	ρ	0.73	
Perceived Ring width	Rw	-0.46	Visual rating
Perceived Regularity	Reg	-0.31	
Perceived Cutting	Cut.	-0.41	
Perceived Latewood %	Lw%	0.27	
Perceived Gloss	Gloss	-0.41	
Perceived Colour	Colour	-0.20	
Perceived Hazelgrowth	Hg.	-0.20	

Fig.5

quality rating for blank plates), which was also well perceived by makers ($R=-0.89$ between evaluation of attribute and measured property). However, during our test, since the geometry of the wood blanks was constant, the density evaluation was not made under the same conditions as those that usually apply for makers. Their rating of density is directly due to an approximation of the perceived mass. Thus it is questionable whether, in real life condition with the blank-plates of varying dimensions, the estimation would have been as strongly correlated to actual measurements as the results that we obtained.

Top plate average ratings and variation range obtained during the four phases of the psychosensory test.

Table 3

Correlations between sensory attributes and their quality rating evaluation. A value in bold indicates a significant correlation according to the Pearson-Bravais table with an α -risk of 0.05.

Fig.6

		Perceived					
		Pitch	Len.	Cry.	Rou.	Hard.	ρ
Optical characteristics measurement	Ring width	-0.57	0.6	0.33	-0.55	-0.43	0.33
	Latewood	0.63	-0.07	-0.06	0.83	0.93	-0.82
	ring width regularity	-0.33	0.79	0.37	-0.25	-0.2	0.11
	a* color parameter	0.06	-0.01	-0.37	0.73	0.74	-0.6
	b* color parameter	0.24	-0.02	-0.2	0.78	0.82	-0.66
	L* color parameter	0.04	-0.14	0.19	-0.66	-0.68	0.61
	Gloss	0.9	-0.1	0.23	0.59	0.44	-0.53
Longitudinal properties measured	Density ρ	0.56	-0.07	-0.12	0.86	0.97	-0.89
	E_L/ρ	0.92	-0.43	0.21	0.43	0.41	-0.49
	$\tan\delta_L$	-0.98	0.33	-0.3	-0.4	-0.38	0.58
	E_L	0.85	-0.34	0.01	0.75	0.81	-0.8
	z_L	0.77	-0.24	-0.02	0.82	0.89	-0.86
	R_L	-0.03	-0.17	0.24	-0.59	-0.78	0.69
	ACE _L	0.68	-0.42	0.32	-0.15	-0.27	0.06
Radial properties measured	E_R/ρ	-0.75	-0.1	-0.5	-0.41	-0.33	0.33
	$\tan\delta_R$	-0.11	0.05	0.13	-0.12	-0.35	0.62
	E_R	-0.09	-0.13	-0.55	0.49	0.64	-0.58
	z_R	0.3	-0.09	-0.34	0.77	0.9	-0.85
	R_R	-0.82	-0.02	-0.23	-0.75	-0.77	0.79
	ACE _R	-0.63	-0.03	-0.3	-0.55	-0.43	0.28
Anisotropic ratios measured	$E_L/\rho / E_R/\rho$	0.91	-0.22	0.37	0.42	0.37	-0.41
	$\tan\delta_R / \tan\delta_L$	0.43	-0.2	0.24	0.07	-0.15	0.3
	E_L/E_R	0.89	-0.26	0.34	0.42	0.39	-0.41
	z_L/z_R	0.87	-0.26	0.35	0.44	0.42	-0.43
	R_L/R_R	0.94	-0.12	0.42	0.44	0.36	-0.44
	ACE _L /ACE _R	0.65	-0.21	0.3	0.19	0.01	0.08

		Perceived						
		Rw	Reg.	Cut.	Lw %	Gloss	Color	Hg
Optical characteristics measurement	Ring width	0.93	0.6	0.59	0.23	0.38	-0.28	0.09
	Latewood	-0.4	-0.1	0.13	-0.58	-0.13	0.58	-0.09
	ring width regularity	0.78	0.47	0.55	-0.43	0.67	0.25	0.23
	a* color parameter	-0.27	-0.01	0.13	-0.64	0.18	0.82	0.51
	b* color parameter	-0.33	-0.14	0.04	-0.68	0.09	0.71	0.34
	L* color parameter	0.11	0.07	-0.09	0.52	-0.34	-0.78	-0.55
	Gloss	-0.55	-0.38	-0.12	0	-0.63	0	-0.02
Longitudinal properties measured	Density ρ	-0.37	-0.05	0.19	-0.55	-0.12	0.65	0.03
	E_L/ρ	-0.67	-0.56	-0.37	0.15	-0.8	-0.25	-0.39
	$\tan\delta_L$	0.59	0.53	0.24	-0.05	0.79	0.16	0.26
	E_L	-0.63	-0.36	-0.11	-0.26	-0.54	0.25	-0.21
	z_L	-0.55	-0.26	0	-0.36	-0.4	0.4	-0.13
	R_L	-0.06	-0.29	-0.47	0.76	-0.35	-0.87	-0.29
	ACE _L	-0.5	-0.58	-0.5	0.49	-0.85	-0.68	-0.37
Radial properties measured	E_R/ρ	0.32	0.43	0.29	0.12	0.17	0.07	0.46
	$\tan\delta_R$	-0.13	-0.21	-0.5	0.33	0.17	-0.46	-0.44
	E_R	-0.07	0.34	0.49	-0.39	-0.02	0.68	0.52
	z_R	-0.25	0.16	0.4	-0.53	-0.1	0.75	0.33
	R_R	0.39	0.27	-0.01	0.38	0.26	-0.35	0.17
	ACE _R	0.43	0.41	0.36	0.09	0.1	0.02	0.45
Anisotropic ratios measured	$E_L/\rho / E_R/\rho$	-0.56	-0.55	-0.39	-0.05	-0.51	-0.17	-0.52
	$\tan\delta_R / \tan\delta_L$	-0.49	-0.51	-0.65	0.31	-0.29	-0.51	-0.57
	E_L/E_R	-0.58	-0.57	-0.43	-0.03	-0.51	-0.19	-0.56
	z_L/z_R	-0.57	-0.56	-0.42	0.02	-0.51	-0.2	-0.56
	R_L/R_R	-0.51	-0.51	-0.31	-0.04	-0.51	-0.14	-0.42
	ACE _L /ACE _R	-0.56	-0.56	-0.6	0.18	-0.39	-0.41	-0.58

Fig.6 Correlations matrix between attributes perceived by makers and material characteristics and properties. A value in a black cell indicates a significant correlation according to the Pearson-Bravais table with an α -risk of 0.05.

Next, the visual quality rating of top plates was mainly based on the perceived “ring width” (attribute also highly correlated to optical/structural measurements), and to the “cutting plane” and “gloss” attributes. The perception of colour and ring width by makers is fairly accurate when compared to the physical measurements. Furthermore, their perception of attributes of latewood percentage and colour gives them indirect information on the longitudinal radiation ratio, while gloss is correlated with both longitudinal specific modulus and damping.

Finally, in **Fig.7** we could see the correlations between the physical, mechanical and vibrational properties of wood with the general quality ratings evaluated according to the four modalities of the test (auditory, tactile, visual and overall). As expected, the tactile evaluation of quality rating is significantly correlated to the measured wood density. It is also well related to both longitudinal and radial wood vibrational properties and indexes (such as impedance or radiation ratio) and to optical

characteristics such as latewood percentage and colour. The visual quality rating evaluation shows a significant correlation with Young’s modulus and specific modulus of elasticity in both longitudinal and radial directions and is also well related to damping and characteristic impedance. The overall quality rating evaluation of spruce plates by the makers is significantly correlated with longitudinal radiation ratio, considered to be a good criterion to describe the resonance woods. It appears that the makers’ perception of visual and tactile attributes gives an indirect—but accurate—indication of the wood’s physical and mechanical properties, while the overall evaluation is a reliable indicator of the radiation ratio.

5. Conclusion

The originality of our approach allowed us not only to explore the question of wood selection under different research areas that are complementary but usually compartmentalised, but also to bring qualified discussion combining different points of view. The survey gave information on the criteria used by the luthiers to choose their wood and a more accurate vision of the parameters that are actually relevant for conducting the physical-mechanical and optical characterisation of resonance woods. The combination of sensory perception and survey study allowed us to better understand the mechanism of material selection by instrument-makers. The contrast between sensory perception and opinion led us to address a variety of subjects, such as the question of the intellectualisation of a gesture or disparity between the makers’ opinion and their actual action. Finally, the opinion and perception of the makers and the scientifically determined characteristics of the materials emphasized each other. This particular aspect is a crucial illustration of the benefit, for the future, of a decompartmentalized approach on studying the aspect of wood selection adapted to a given usage.

Fig.7

		Auditory Rating	Tactile Rating	Visual Rating	Overall Rating
Optical characteristics measurement	Ring width	0.52	0.17	0.2	-0.23
	Latewood	0	-0.68	-0.63	-0.52
	ring width regularity	0.18	-0.03	0.23	-0.65
	a* color parameter	-0.33	-0.61	-0.09	-0.58
	b* color parameter	-0.18	-0.65	-0.3	-0.58
	L* color parameter	0.15	0.73	0.13	0.61
	Gloss	0.3	-0.38	-0.77	-0.1
Longitudinal properties measured	Density ρ	0.01	-0.77	-0.61	-0.56
	E_L/ρ	0.28	-0.29	-0.78	0.24
	$\tan\delta_L$	-0.27	0.36	0.74	-0.11
	E_L	0.11	-0.6	-0.77	-0.17
	z_L	0.1	-0.69	-0.75	-0.33
	R_L	0.2	0.67	0.11	0.78
	ACE_L	0.23	0.23	-0.37	0.63
Radial properties measured	E_R/ρ	-0.37	0.27	0.77	0.1
	$\tan\delta_R$	0.11	0.54	-0.08	0.42
	E_R	-0.28	-0.52	0.07	-0.48
	z_R	-0.13	-0.74	-0.33	-0.61
	R_R	-0.25	0.67	0.82	0.43
	ACE_R	-0.3	0.24	0.76	0.06
Anisotropic properties measured	$E_L/\rho / E_R/\rho$	0.27	-0.24	-0.78	0.1
	$\tan\delta_R / \tan\delta_L$	0.16	0.35	-0.41	0.5
	E_L/E_R	0.26	-0.24	-0.78	0.14
	z_L/z_R	0.32	-0.27	-0.82	0.14
	R_L/R_R	0.33	-0.28	-0.81	0.02
	ACE_L/ACE_R	0.18	0.19	-0.55	0.39

Fig.7 Matrix of correlations between quality rating evaluations by makers and the measured material characteristics and properties. A value in a black cell indicates a significant correlation according to the Pearson-Bravais table with a α -risk of 0.05.

ACKNOWLEDGEMENTS: This work was supported by CNRS (Ph.D. grant awarded to C. Carlier) and by Région Languedoc-Roussillon (Young Researcher project/prize awarded to I. Brémaud). We are grateful to the BioWooEB Research Unit of CIRAD, Montpellier for providing access to some of their experimental facilities. Certain specific characterisations were conducted in Japan thanks to E. Obataya (Tsukuba University) and the support of JSPS, and in Italy thanks to J. and A. Sandak (CNR IVALSA) and the support of Trees4Future. Our deepest gratitude goes to the violin makers who contributed to this study, for sharing their experience and ideas on the topic, and for the time they granted to us for completion of the survey and/or taking part in the sensory tests.

References

- [1] I. Brémaud, “Acoustical properties of wood in string instruments soundboards and tuned idiophones: Biological and cultural diversity,” *J. Acoust. Soc. Am.*, vol. 131, no. 1, pp. 807–818, 2012.
- [2] I. Brémaud and N. Poidevin, “Approches culturelles et mécaniques dans le choix des bois en facture: cas des archets anciens,” in *CIM09: Conf. on Interdisciplinary Musicology. Music and Its Instruments*. Paris: Editions Delatour France, 2009.
- [3] I. Brémaud, “Vers une vision ‘ethno-bio-mécanique’ des bois - La rhéologie du matériau-bois à l’interface entre diversité botanique et usages en lutherie et artisanats,” Univ. Montpellier, 2016, p. 149.
- [4] V. Bucur, *Acoustics of Wood*, 2nd ed. Berlin: Springer-Verlag, 2006, p. 393.
- [5] V. Bucur, *Handbook of Materials for String Musical Instruments*. Switzerland: Springer International, 2016, p. 975.
- [6] C. Buksnowitz *et al.*, “Resonance wood [Picea abies (L.) Karst.] – evaluation and prediction of violin makers’ quality-grading,” *J. Acoust. Soc. Am.*, vol. 121, no. 4, p. 2384–2395, 2007.
- [7] A. Tolbecque, *L’art du luthier*. Niort: author (printer: Th. Mercier), 1903.
- [8] I. Brémaud, “What do we know on ‘resonance wood’ properties? Selective review and ongoing research,” in *Proc. Acoustics 2012, Nantes*.
- [9] C. Carlier, “Une approche décloisonnée des ‘bois de résonance’ d’épicéa et d’érable : critères de sélection et variabilité du matériau en lutherie du quatuor sous les points de vue artisanaux, mécaniques, acoustiques et sensoriels,” Univ. Montpellier, 2016, p. 169.
- [10] A. S. Allen, “Fatto di Fiemme’: Stradivari’s violins and the musical trees of the Paneveggio,” in L. Auricchio, E. H. Cook, and G. Pacini, Eds., *Invaluable Trees: Cultures of Nature, 1660–1830*. Oxford: Voltaire Foundation, 2012, p. 301–15.
- [11] V. Klein and B. Buob, Eds. *Luthiers de la main à la main*. (n.p.): Actes Sud, 2012, p. 192.
- [12] C. Carlier, I. Brémaud and J. Gril, “Violin making ‘tonewood’: comparing makers’ empirical expertise with wood structural/visual and acoustical properties,” in *Proc. Int. Symp. on Musical Acoustics ISMA2014*, Le Mans, 2014.
- [13] C. Carlier, I. Brémaud and J. Gril, “The role of tonewood selection and aging in instrument ‘quality’ as viewed by violin makers,” in *Proc. 3rd Annual COST Action FP1302 WoodMusICK Conf.*, London, 2015, pp. 9–10.
- [14] I. Brémaud, J. Gril and B. Thibaut, “Anisotropy of wood vibrational properties: Dependence on grain angle and review of literature data,” *Wood Science and Technology*, vol. 45, p. 735–754, 2011.
- [15] C. Barlow, “Material selection for musical instruments,” in *Proc. Institute of Acoustics*, vol. 19, no. 5, p. 69–78, 1997.
- [16] E. Obataya, T. Ono and M. Norimoto, “Vibrational properties of wood along the grain,” *J. Materials Science*, vol. 35, p. 2993–3001, 2000.
- [17] D. W. Haines, “The essential mechanical properties of wood prepared for musical instruments,” *Catgut Acoust. Soc. J.*, vol. 4, no. 2, p. 20–32, 2000.
- [18] H. Yano, I. Matsuoka and J. Mukudai, “Acoustic properties of wood for violins,” *Mokuzai gakkaiishi*, vol. 38, no. 2, p. 122–127, 1992.

- [19] J. C. Schelleng, “The violin as a circuit,” *J. Acoust. Soc. Am.*, vol. 35, no. 3, p. 326–338, 1963.
- [20] R. Viala *et al.*, “Model-based effects screening of stringed instruments,” in *Model Validation and Uncertainty Quantification, Vol. 3: Proc. 34th IMAC, Conf. and Exposition on Structural Dynamics 2016*. (n.p.): Springer, 2016, p. 151–157.
- [21] A. Alkadri *et al.*, “Relationships between anatomical and vibrational properties of wavy sycamore maple,” *LAWA Journal*, vol. 39, no. 1, p. 63–86, 2018.
- [22] Y. Kubojima, T. Okano and M. Ohta, “Effect of annual ring widths on structural and vibrational properties of wood,” *Mokuzai gakkaiishi*, vol. 43, no. 8, p. 634–641, 1997.
- [23] M. Aramaki *et al.*, “Sound quality assessment of wood for xylophone bars,” *J. Acoust. Soc. Am.*, vol. 121, no. 4, p. 2407–2421, 2007.
- [24] E. Fouilhé, A. Houssay and I. Brémaud. “Dense and hard woods in musical instrument making: Comparison of mechanical properties and perceptual ‘quality’ grading,” in *Proc. Acoustics 2012*, Nantes, pp. 23–27.

Non-Destructive Investigation of Historical Instruments Based on 3D-Reflected-Light Microscopy and High-Resolution μ -X-ray CT

VOLKER HAAG (1), SEBASTIAN KIRSCH (2), GERALD KOCH (1),
VALENTINA ZEMKE (3), HANS-GEORG RICHTER (4),
SERGEJ KASCHURO (1)

(1) Thünen Institute of Wood Research, Hamburg, Germany

(2) Germanisches Nationalmuseum, Nürnberg, Germany

(3) Department of Wood Biology, Centre of Wood Research, University of Hamburg, Germany

(4) Formerly Federal Research Centre of Forestry and Forest Products, Hamburg, Germany

Abstract

The present paper describes two technical approaches and practical applications of non-destructive microscopic investigation methods which are ideally suited for wood identification and dendrochronological measurements of cultural (heritage) objects, e.g. musical instruments. 3D-reflected-light microscopy enables the scientist to study individual components in historical instruments without the destructive preparation of microscopic slides from detached wood blocks. This special technique offers a new methodical approach for determining which timbers are traditionally used for certain components in historic plucked and stringed instruments. In addition, X-ray micro computed tomography (CT) is an established method for the examination of musical instruments. High-resolution μ -CT-ray images can provide information for structural analysis, dendrochronology and wood identification.

1. Introduction

In the history of musical instrument manufacture, traditional instrument-makers often used “bequeathed” wood species for the individual components of the instrument, which are characterized by a specific texture and defined wood properties to produce a high-quality sound. Based on this experience passed down for generations, there is considerable interest among present-day instrument-makers as to which wood species were used by the “old” masters, such as Torres or Stradivarius. The standard non-destructive method for wood identification is macroscopic assessment of structural features. Results emanating from macroscopic identification, however, must be considered tentative (**Fig.1**, left) as the possibilities of macroscopic wood identification are much more limited than those of a microscopic study. Firstly, the number of characters available for observation is considerably smaller. Secondly, in macroscopic identification one fairly often has to rely on characters subject to high variability due to different growth conditions of the tree (*viz.* formation of growth rings) or exposure to oxygen and UV radiation (*viz.* wood colour). This may lead to subjective judgement on behalf of the user, and errors that might result in wrong decisions. On the other hand, for the identification of wood species in historical instruments, a microscopic examination is mostly impossible as such instruments are very costly, and no samples can be prepared for microscopy. In practice, the use of macroscopic characters will probably come up with a choice of several likely matches whose safe separation would have to be left to microscopic analysis (**Fig.1**, right). For “official” or “judicable” wood identification, microscopic analyses are routinely conducted. Using light microscopic techniques, up to 90 internationally standardized anatomical characters are available as published in the IAWA Lists of Microscopic Features for Hardwood and Softwood Identification [1, 2]. These microscopic features describe the individual characters of cell and tissue types, i.e., vessels, fibres, and both

Fig.1

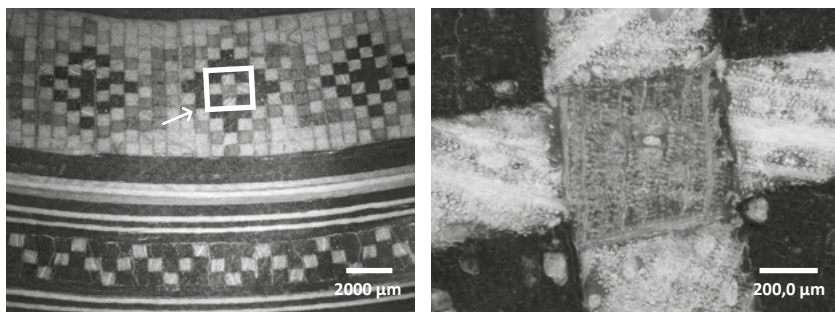

Fig.1 Soundhole inlay at the macroscopic level (left) and at the microscopic level (right) on a historical guitar made by Francisco Simplicio in 1924.

ray and axial parenchyma. Additional information is provided on mineral inclusions as part of the “anatomical fingerprint”. Based on these requirements, the use of digital 3D reflected light microscopy allows for microscopic observation of flat and also uneven surfaces of solid wooden components down to the smallest marquetry work, without damaging these components.

Wood identification is also part of the standard research in conservation science. In cases where missing parts have to be replaced, it can be useful to know the wood species originally used. Since some wood species can emit acids, specific damages can be explained by identifying the species. Finally, wood identification gives an idea of the economic possibilities an instrument-maker had in order to realize his ideas of the instrument’s aesthetic and sound properties.

2. Methods

D-reflected-light microscopy

As part of the STSM (Short Time Scientific Mission) project “Non-destructive wood identification of historical instruments based on 3D-reflected-light microscopy”, scientists investigated eleven high-value instruments of the Museu de la Música, Barcelona on a standard macroscopic level using non-destructive tools (different kinds of hand lenses etc.) as well as digitized image microscope analysis systems (Cell[^]F®, Olympus and KEYENCE® VHX-5000/**Fig.2**) on the microscopic level.

Fig.2



Fig.2 Microscopic investigation of a historical guitar (Beau, build in 1844. MDMB 456) with the digitized image analysis system.

For microscopic analysis, close-up digital images of the investigated instrument components were taken and relevant histometrical data was recorded. Images of the anatomical structures (**Fig.4** and **Fig.5(A,B,C)**) and data (measurements, etc.) were compared with information available from computer-assisted wood identification systems (*Commercial timbers*, *macroHOLZdata*, *CITESwoodID* and *Softwoods*) [3, 4, 5, 6]. The microscopic features of the investigated components of the different instruments were then compared with vouchered reference specimens from the scientific wood collection (Federal Research Institute for Rural Areas, Forestry and Fisheries, Hamburg, Germany).

3D-X-ray computed tomography (CT)

For 3D-X-ray computed tomography (CT) imaging of an object, a large number of single images are recorded from several angles, and then merged into a 3D volume. This imaging technique has been used in medical diagnostics since the late 1960s, and is also used for non-destructive testing in industrial production processes. While medical CT facilities are optimized for the human body, industrial micro-CT facilities are adjustable for several objects and varying sizes, and a higher spatial resolution can be achieved. With a resolution of 100 µm or better, detailed scientific questions concerning musical instruments can be answered. The 3D images provide a view inside the instruments, and measurements can be taken at all otherwise inaccessible locations. Using this technique, the conservation status of the instrument can also be analysed. The wooden structure is made visible, e.g. in cross sections of quarter-sawn top plates of stringed instruments, and the width of the annual rings can be measured and used for dendrochronological dating.

3. Results

3D-reflected-light microscopy

The 3D-reflected-light microscopy for macroscopic and microscopic wood identification was applied to each of the eleven selected instruments (approximate year of construction between 1650 and 1953).

Systematic examination of the main components, such as the head, neck, back and sides, as well as the resonance board, were carried out. Furthermore, for six instruments, small wooden components of the mechanics, e.g., pegs, bridge, saddle, and decorative elements such as marquetry and inlays of a sound hole rosette, were also analysed.

The results of the studies reveal that the non-destructive 3D-reflected-light microscopy mostly matches the resolution of established transmitted light microscopy for wood identification.

a) Hardwoods

The technique allows for the differentiation of closely related species, such as those belonging to the genera *Swietenia* and *Cedrela* (MELIACEAE), which are protected according to CITES regulations (referring to logs, sawn timber and veneer sheets). **Fig.4** shows a high magnification microscopic image of the surface of the neck of a guitar (Ignazio Fleta, 1953) enabling the measurement of the average intervessel pit size. The results revealed minute pits of about 2 µm, which are typical for species of the genus *Swietenia*.

This excludes species of the genus *Cedrela* with a very similar colour and texture but distinctly larger pits (of approximately 5–7 µm). However, in some cases, structural analysis of large sections is not possible due to constructive restrictions.

Fig.3



For example, the large transverse sections of framed fingerboards or inlays are inaccessible. In these cases, analysis is restricted to the anatomical features accessible on the tangential and radial faces. **Fig.5(A)** shows the tangential section of a fingerboard from a nineteenth-century classical guitar. The image was taken with the 3D-reflected-light microscope showing the anatomical structure of species of the botanical genus *Diospyros* (Black ebony). This structure can be clearly distinguished from those depicted in **Fig.5(B)** and **Fig.5(C)**, taken by “conventional” light microscopy and showing the tangential sections of “lookalike” timbers such as *Dalbergia melanoxylon* (African blackwood) and *Juglans regia* (European walnut).

Fig.3 Spanish Guitar (made in 1650 – 1700/ MDMB 639) with marquetry in walnut (*Juglans regia*) on the fingerboard and soundboard.

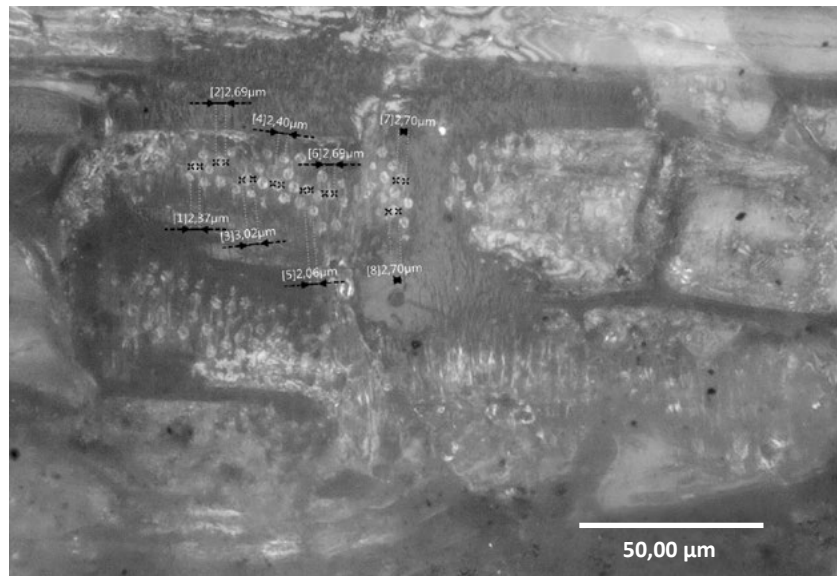
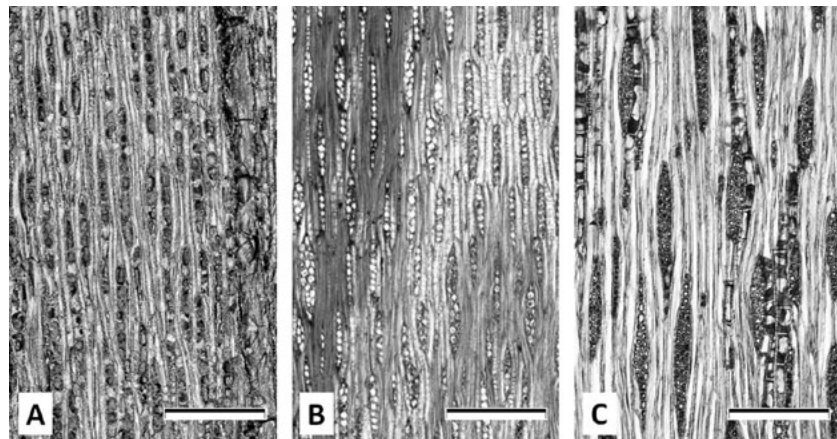
Fig.4**Fig.5**

b) Softwoods

Due to the homogenous cellular structure of softwoods, corresponding to roughly 95% of a single cell type—tracheids—reliable differentiation of genera or species in the components of musical instruments is often difficult. Attempts to differentiate between certain groups of softwoods the primary macroscopic feature is “presence vs. absence” of

Fig.4 Measurement of the average intervessel pit size (vertical) in wood of the neck (classical guitar, Iganzio Fleta, 1953 /MDMB 1408).

Fig.5 Tangential sections of *Diospyros* sp. (A), *Dalbergia melanoxydon* (B) and *Juglans regia* (C). Scale bars: A-C = 200 µm.

intercellular (resin) canals. A secondary feature sometimes helpful for further separation of taxa is the transition from earlywood to latewood within a growth ring, which can be either abrupt (for instance *Larix* sp.) or gradual (*Picea* sp.).

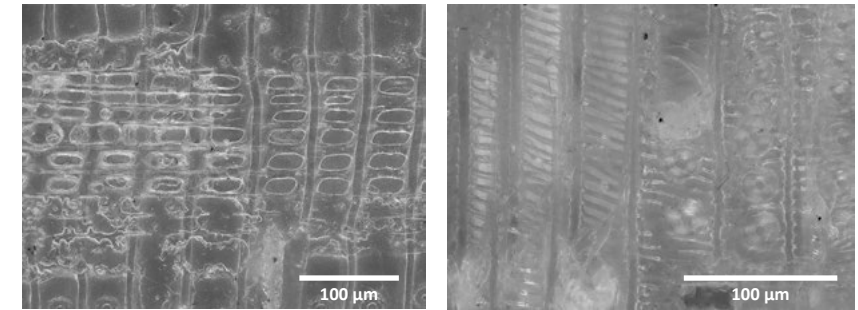
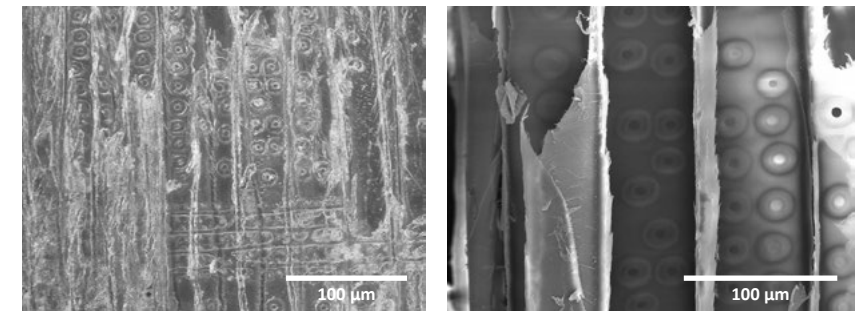
Fig.6**Fig.7**

This rather low-level macroscopic approach to softwood identification can be distinctly improved by using non-destructive 3D-reflected-light microscopy. This allows for the observation of wood structural features otherwise only accessible by means of destructive methods (light microscopy and SEM). Features that can be assessed by this method are, for example, cross-field pitting and the presence of helical thickenings.

The occurrence of “window-like” (pinoid 1) cross-field pitting in Scots pine (*Pinus sylvestris* Fig.6, left) or the presence of helical thickenings in longitudinal tracheids (Fig.6, right) are characteristic of very few species, such as Douglas fir (*Pseudotsuga menziesii*) or Common yew

Fig.6 3D-reflected-light microscopy images of “window-like” (pinoid 1) cross-field pitting (left) in Scots Pine (*Pinus sylvestris*) and helical thickenings (right) in Douglas fir (*Pseudotsuga menziesii*). Scale bars: 100 µm.

Fig.7 (left) 3D-reflected-light microscopy image of a Spruce (*Picea* sp.) soundboard of classical guitar (Beau, Mirecourt 1844/MDMB 456) with partially multiserial tracheid pits; (right) SEM image (courtesy T. Potsch) of Larch (*Larix decidua*) with “characteristic multiserial tracheid pits”. Scale bars: 100 µm.

Fig.8**Fig.9****Fig.10**

Fig.8 3D-reflected-light microscopy image of a radial surface of larch (*Larix* sp., left) showing a radial resin canal (RC), ray tracheids (RT), ray parenchyma cells (PC) and ray tracheid pits (box). Scale bar: 100 µm.

Fig.9 (left) Light microscopic image (and schematic drawing) of a radial section of *Larix* sp. with ray tracheid pitting, and (right) an image obtained using non-destructive 3D reflected-light microscopy. Scale bar: 100 µm.

Fig.10 (left) Light microscopic image (and schematic drawing) of a radial section of *Picea* sp. with ray tracheid pitting, and (right) an image obtained using non-destructive 3D reflected-light microscopy. Scale bar: 100 µm.

(*Taxus baccata*), The identification of other “similar” species must be left to the detailed analysis of further structural features. For example, Bartholin published a paper [7] that deals specifically with the “the *Picea*–*Larix* problem” and highlights a special structural feature, the aperture (opening) of the pits between ray tracheids (**Fig.8** and **Fig.9**, box), in order to distinguish between the two genera.

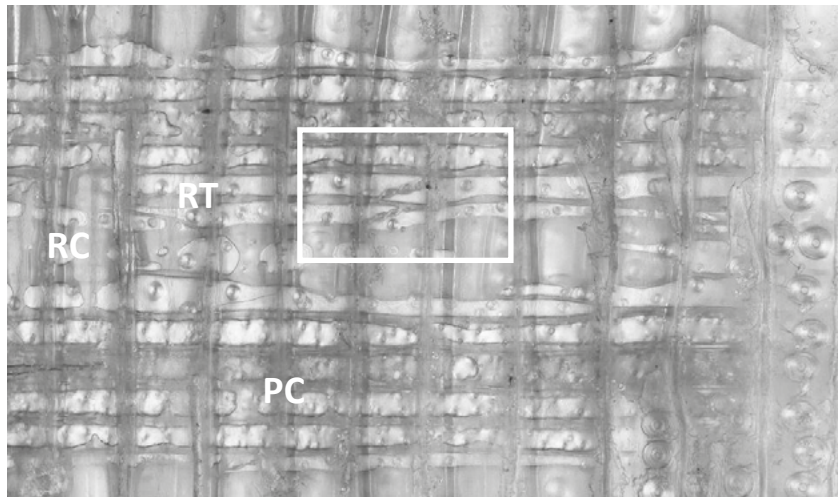
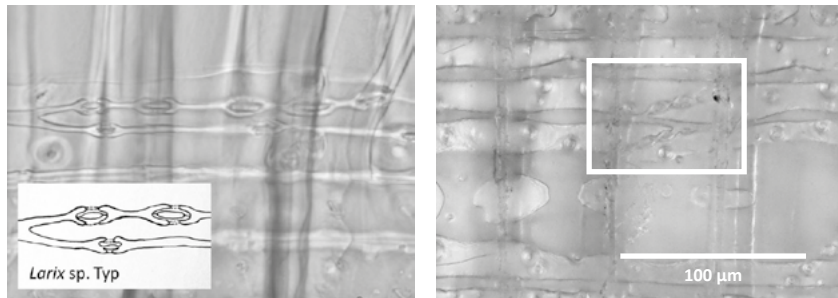
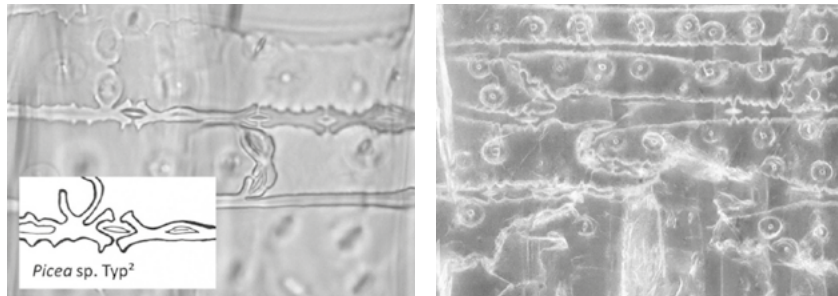
In *Larix* sp., the pits have a distinctly elongated shape with a wide opening or porus [**Fig.9**], and in *Picea* sp., they have a rather squat form, with a narrow opening or porus and serrated “humps” at the edges [**Fig.10**]. **Fig.9** and **Fig.10** clearly show that the images obtained using non-destructive 3D reflected-light microscopy allow for differentiation between spruce and larch based on these anatomical structures. In both figures, a light microscopic picture of a radial section (24 µm with a small schematic representation) on the left side is compared with a 3D-optical-micrograph of the same type of wood on the right side.

Table 1 summarizes the results of five of the investigated instruments at the Museu de la Música, Barcelona. In several cases, a more specific attribution than that listed in the table (e.g., to family, genus or “softwoods”) turned out to be out of reach because certain components inside the instrument body (such as the top and back braces) are inaccessible for a close-up 3D scan. Therefore, further differentiation of the softwoods or MELIACEAE used for these components is all but impossible.

Table 1	(1) Antonio de Torres (1859) MDMB 626	(2) Antonio de Torres (1862) MDMB 625.	(3) Antonio de Torres (1889) MDMB 12101.	(1) Enrique Garcia (1913) MDMB 1700.	(5) Francisco Simplicio (1924) MDMB 1444.
I	<i>Cedrela odorata</i> (Cedro)	<i>Cedrela odorata</i> (Cedro)	<i>Cedrela odorata</i> (Cedro)	<i>Cedrela odorata</i> (Cedro)	<i>Cf. Swietenia</i> sp. (Mahogany)
II	<i>Dalbergia cf. nigra</i> (Braz. Rosewood)	<i>Dalbergia cf. nigra</i> (Braz. Rosewood)	<i>Dalbergia</i> sp. (Rosewood)	<i>Dalbergia cf. nigra</i> (Braz. Rosewood)	<i>Diospyros</i> sp. (Ebony)
III	<i>Cedrela odorata</i> (Cedro)	<i>Cedrela odorata</i> (Cedro)	<i>Cedrela odorata</i> (Cedro)	<i>Cedrela odorata</i> (Cedro)	<i>Cf. Swietenia</i> sp. (Mahogany)
IV	<i>Cedrela odorata</i> (Cedro)	<i>Cedrela odorata</i> (Cedro)	<i>Cedrela odorata</i> (Cedro)	<i>Cedrela odorata</i> (Cedro)	<i>Cf. Swietenia</i> sp. (Mahogany)
V	<i>Dalbergia cf. nigra</i> (Braz. Rosewood)	Paperboard/ Carton	<i>Cupressus</i> sp. (Cypress)	<i>Dalbergia cf. nigra</i> (Braz. Rosewood)	<i>Dalbergia</i> sp. (Rosewood)
VI	<i>Dalbergia cf. nigra</i> (Braz. Rosewood)	Paperboard/ Carton	<i>Cupressus</i> sp. (Cypress)	<i>Dalbergia cf. nigra</i> (Braz. Rosewood)	<i>Dalbergia</i> sp. (Rosewood)
VII	<i>Diospyros</i> sp. (Ebony)	<i>Dalbergia cf. nigra</i> (Braz. Rosewood)	<i>Dalbergia cf. nigra</i> (Braz. Rosewood)	<i>Diospyros</i> sp. (Ebony)	<i>Diospyros</i> sp. (Ebony)
VIII	<i>Dalbergia cf. nigra</i> (Braz. Rosewood)	<i>Dalbergia cf. nigra</i> (Braz. Rosewood)	<i>Dalbergia</i> sp. (Rosewood)	<i>Dalbergia</i> sp. (Rosewood)	<i>Dalbergia</i> sp. (Rosewood)
IX	Bone	Bone	Bone	Bone	Bone
X	Bone	Bone	Bone	Bone	Bone
XI	<i>Picea abies</i> (Spruce)	<i>Picea abies</i> (Spruce)	<i>Picea abies</i> (Spruce)	<i>Picea abies</i> (Spruce)	<i>Picea abies</i> (Spruce)
XII	not visible	Softwood	not visible	Softwood	Softwood
XIII	MELIACEAE	MELIACEAE	Softwood	MELIACEAE	MELIACEAE
XIV	Softwood	Softwood	Softwood	MELIACEAE	MELIACEAE
XV	Softwood	Softwood	Softwood	Softwood	Softwood
XVI	<i>Fagus sylvatica</i> <i>Dalbergia</i> sp. <i>Acer</i> sp. MELIACEAE.	Not part of study	Not part of study	<i>Acer</i> sp. <i>Dalbergia</i> sp.	<i>Acer</i> sp. <i>Dalbergia</i> sp.

Sp. = Species; Cf = Best agreement with; CAPITAL LETTERS = botanical family;
Italics = botanical *genus* and *species*; (between parentheses) = trade name.

I = Head VI = Back XI = Soundboard XVI = Purfling
II = Headplate VII = Fingerboard XII = Tail Block and Bindings
III = Neck VIII = Bridge XIII = Back Graft
IV = Heal IX = Nut XIV = Back Brace
V = Sides X = Saddle XV = To Brace

Table 1 Excerpt of results of the study at the Museu de la Musica, Barcelona.

3D-X-ray computed tomography (CT)

The project MUSICES (MUSical Instruments Computed tomography Examination Standard) was funded by the German Research Foundation (Deutsche Forschungsgemeinschaft) and developed guidelines for the examination of musical instruments with X-ray computed tomography. For this purpose, over a span of three years, more than 100 instruments were scanned, with different scientific issues. One idea was to use this imaging technique for the dendrochronological dating of top plates of stringed musical instruments.

Fig.11

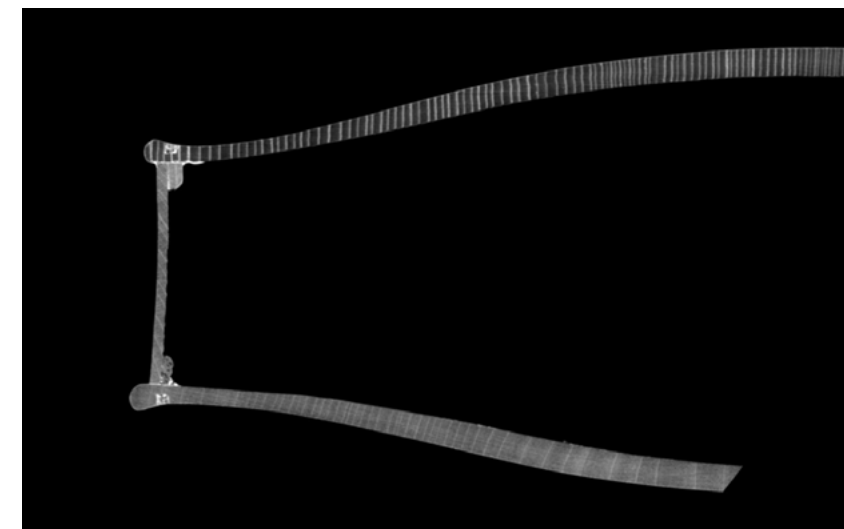

Due to the fact that soundboards are usually made of extremely fine-grained wood, the resolution has to be sufficiently high so that the individual annual rings can be distinguished. **Fig.11** shows the cross section of the top plate of a violin made by Matthias Hummel, Nuremberg 1681 (Germanisches Nationalmuseum, Inv. No. MI 419). The soundboard is book-matched, and the width of the annual rings is quite similar on the bass and treble side. The measurement of 107 annual rings matches very well the course of the reference curve “Dachstein Schwarzensee” (SWsPA). The dating of the youngest annual ring is 1636. Considering the fact that the natural wane (sapwood bevel) was nearly always eliminated from the raw material for soundboards and that wood was stored and dried before processing, this date agrees very well with that of instrument production signed by Matthias Hummel.

Fig.11

Cross section of a violin body (Matthias Hummel, Nuremberg 1681, Germanisches Nationalmuseum, Inv. No. MI 419, Nürnberg/Fraunhofer EZRT).

For tree-ring width measurement and dendrochronological dating, a spatial resolution of 100 μm is usually sufficient. In some cases, the image quality obtained allows for the safe differentiation between certain hardwoods and softwoods due to the presence of accessible diagnostic structural features.

Fig.12

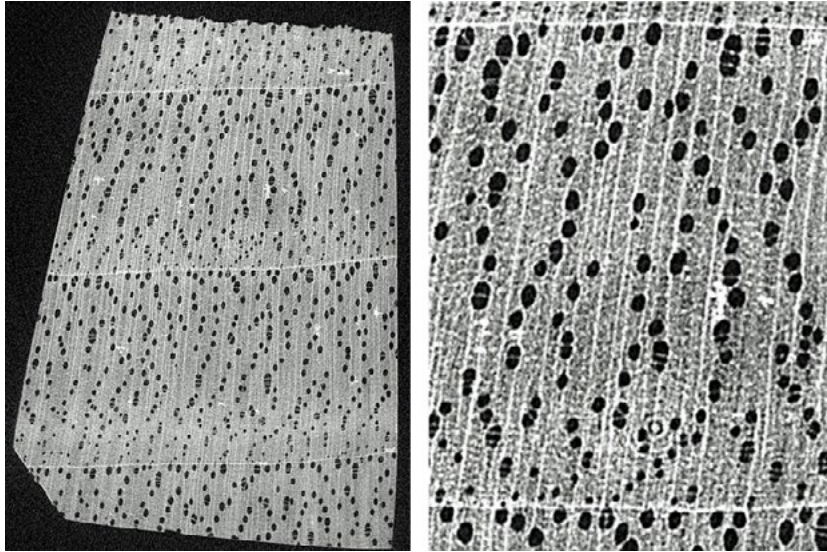

To estimate the potential for identifying wood using micro-CT, scans of smaller samples were taken. Fig.12 (right, left) shows the cross section of a walnut (*Juglans regia*). Walnut can be easily distinguished from other native wood species due to its characteristic semi-ring-porous structure and the clearly visible axial parenchyma (diffuse-in-aggregates) forming fine, slightly undulating lines parallel to the growth ring boundaries.

4. Conclusion

The present study shows that the technical approach of the 3D-reflected-light microscopy is ideally suited for the non-destructive wood identification of cultural heritage objects, including musical instruments. Within the STSM project, approximately 120 individual components of eleven historical instruments were analysed and identified.

Equally, dendrochronological investigations based on high-resolution $\mu\text{-X-ray}$ CT show promising results. For wood anatomical inves-

tigations, the method is currently only partially suitable. Safe differentiation between hardwood timbers succeeds only in certain cases. The success of such studies is currently limited by low resolution imaging, which does not allow access to certain wood structural details. Hence, the differentiation of closely related tropical wood species with very similar structural characteristics is currently not possible. These results show very good agreement with the studies of Grabner *et al.* [8], Sondini *et al.* [9], and Stelzner *et al.* [10]. More precise differentiation can only be achieved by evaluating additional anatomical features (see above). In order to be able to make more precise statements, measurements with higher resolutions are therefore necessary and should be part of subsequent investigations.

5. Dendrochronological Measurements

The dendrochronological measurements were performed by Valentina Zemke, MSc, University of Hamburg, Germany, and Dr Michael Grabner and Elisabeth Wächter, BSc of the Universität für Bodenkultur Wien (BOKU), Vienna, Austria. Statistical similarity values of the mean curve of MI 419 with the “Dachstein Schwarzensee Chronology” (SWsPA): Glk = 70, GSL = 99.9, TVH = 8.4

ACKNOWLEDGEMENTS: The authors gratefully acknowledge the technical and scientific team of the Museu de la Música, Barcelona who prepared every instrument for the study undertaken in Barcelona. Special thanks go to Marisa Ruiz Magaldi, Esther Fernandez Cabrera, Sara Guasteví Olives, Manel Barcons Carbonell and Jaume Ayats i Abeyà who made these investigations possible.

Fig.12 Cross section of *Juglans regia* from a 3D-X-ray computed tomography (CT) measurement.

References

- [1] IAWA Committee: H. G. Richter, D. Grosser, I. Heinz, and P. E. Gasson, Eds., "IAWA list of microscopic features for softwood identification," *IAWA Bulletin n.s.*, vol. 25, no. 1, pp. 1-70, 2014.
- [2] IAWA Committee: E. Wheeler, P. Baas, and P. E. Gasson, Eds., "IAWA list of microscopic features for hardwood identification," *IAWA Bulletin n.s.*, vol. 10, no. 3, pp. 219-332, 1989.
- [3] H. G. Richter, K. Gembruch, and G. Koch, *CITESwoodID – Innovative medium for education, information and identification of CITES protected trade timbers* (CD-ROM). Federal Agency for Nature Conservation (BfN) and Federal Research Centre for Forestry and Forest Products (BFH), 2005. Available: <http://www.deltaintkey.com/wood/index.htm>.
- [4] H. G. Richter, M. Oelker, and G. Krämer. *macroHolzdata – Computer-gestützte makroskopische Holzartenbestimmung sowie Informationen zu Eigenschaften und Verwendung von Nutzhölzern* (CD-ROM). Holzfachschule Bad Wildungen, Selbstverlag, 2002.
- [5] H. G. Richter and M. J. Dallwitz (2000 onwards). *Commercial timbers – Descriptions, illustrations, identification, and information retrieval*. In English, French, German, Portuguese and Spanish. Version: May 4, 2000. Available: <http://www.deltaintkey.com/wood/index.htm>.
- [6] H. G. Richter, I. Heinz, and G. Koch (2015 onwards). *Softwoods – Descriptions, illustrations, identification and information retrieval* (CD-ROM). Federal Research Institute for Rural Areas, Forestry and Fisheries. (Unpublished edition).
- [7] T. Bartholin, "The Picea–Larix problem," *IAWA Bulletin*, no. 1, pp. 7-10, 1979.
- [8] M. Grabner, D. Salaberger, and T. Okochi, "The need of high resolution μ -X-ray CT in dendrochronology and in wood identification" in *Proc. 6th Int. Symp. on Image and Signal Processing and Analysis*, pp. 349-352, 2009.
- [9] N. Sodini *et al.*, "Non-invasive microstructural analysis of bowed stringed instruments with synchrotron radiation X-ray microtomography," *Journal of Cultural Heritage*, vol. 13, no. 3, pp. S44-S49, 2012.
- [10] J. Stelzner and S. Million, "X-ray computed tomography for the anatomical and dendrochronological analysis of archaeological wood," *Journal of Archaeological Science*, vol. 55, pp. 188-196, 2015.

X-Ray CT and Neutron Imaging for Musical Instruments – A Comparative Study

SEBASTIAN KIRSCH (1), DAVID MANNES (2)

(1) Germanisches Nationalmuseum, Nuremberg, Germany

(2) Paul Scherrer Institute, Villigen, Switzerland

Abstract

X-ray and neutron imaging depend on different physical processes based on the interaction with matter that results in different characteristics in the output image. X-ray computed tomography (CT) imaging of objects made of low-density materials, like wooden musical instruments, can achieve high quality, while metal objects like brass instruments are much more difficult to depict. For neutron imaging, materials with high densities like metals are easy to penetrate, while imaging of wood can be problematic. Furthermore, using neutron imaging, the water content in objects can be visualised. On the basis of neutron and X-ray CT scans of several objects with different physical properties (a viol, a mouthpiece, keyed woodwind instruments and a wooden sample), the advantages and limitations of both techniques for various scientific issues and applications are discussed.

1. X-Ray and Neutron Imaging for Musical Instrument – Brief History

When Conrad Wilhelm Röntgen undertook his first experiments with X-rays in 1895, he noted the different absorption properties of the various materials. Organic materials like muscles were easily penetrated by the radiation, while more dense materials like bones and metal proved to be strong absorbers. On paintings, areas covered with pigments containing lead were especially hard to penetrate by the newly discovered X-rays. The potential for this technology to revolutionize the examination of artwork was recognized from the very beginning, resulting in the first patent for the investigation of paintings in 1914 by Alexander Faber [1]. Only several decades later the technology was applied to the examination of musical instruments, beginning in 1949 with early X-ray images of a wooden oboe published by Halfpenny [2], but it has been used systematically ever since for the study of such instruments [3]. Shortly after the invention of computed tomography by Godfrey Hounsfield at the end of the 1960s, this technology that generates virtual sections through an object using X-ray transmission images from several angles was first applied for the examination of artworks in 1978 [4]. In the late 1980s, the potential of this technique was transferred to visualize the inner structure of musical instruments [5]. From 2014 to 2018, a team of scientists and conservators of the Germanisches Nationalmuseum in Nuremberg and the Fraunhofer EZRT in Fürth scanned more than 100 instruments during the MUSICES-project and published recommendations for conducting 3D CT scans. Nowadays, X-ray computed tomography is an established tool for the examination of all kinds of cultural heritage objects.

In 1932, when X-rays were already a widespread tool for diagnostics in medical and (art) technological applications, an important discovery concerning the atomic model was made. Sir James Chadwick proved that the neutron exists as an elementary particle, providing the foundation for completing the explanation for the composition of the atomic nucleus. Only three years later, the first successful experiments in neutron radiography were carried out by Hartmut Kallmann and Ernst Kuhn. In 1946, Otto Peter published the first images of industrial, mostly metallic objects. He observed that—unlike X-rays—organic materials and water are not easily penetrated by neutrons but cause a strong attenuation [6]. It took until the 1990s for the first results of neutron tomography to be published [7]. Until now, compared to X-ray imaging, only a small fraction of investigations of cultural heritage objects take advantage of the properties of neutrons that mean metal objects can be penetrated more easily while even small amounts of organic material and water within the studied object provide a high contrast and can be visualised [8, 9].

Musical instruments can consist of various materials with highly differing densities. Therefore, neutron and X-ray imaging—each with their

advantages and limitations—can both be used as complementary methods to answer scientific questions. This paper gives a brief overview on the physics of both techniques and discusses different applications on selected examples representing almost all physical challenges for both methods.

2. X-Ray and Neutron CT – Advantages and Limitations

2.1 Physical Background – Neutron and X-Ray Imaging

In imaging using X-rays and neutrons, an object is placed between a source that emits radiation and a detector. The object itself partially attenuates the radiation by absorption or scattering. What the detector records depends on different factors including the type of radiation, the energy and current of the incident beam, and the properties and thickness of the material.

The nature of the X-ray interaction is with the atomic shell of the irradiated elements. One can imagine in a simplified way that when X-rays hit an atom, the energy that is absorbed lifts single electrons onto higher energetic levels or even causes one electron to leave the shell completely (ionization). Materials such as iron, copper, tin, lead, etc. consist of large atoms with a high number of electrons and high electron density. For higher X-ray energies, Compton scattering also plays an important role, meaning that not only the amount of electrons but also the material's electron density are important. Dense materials can attenuate X-rays better than materials consisting of smaller atoms, such as carbon or hydrogen, which are the main elements of all organic components. How strongly a material attenuates radiation is represented by the specific attenuation coefficient (μ). The transmission of X-rays through a material is expressed by the Lambert-Beer law:

$$I = I_0 e^{-\mu d} \quad (1)$$

In this equation I_0 and I are the beam intensities before and after transmission of the object, d is the transmitted length of the material, and μ is the attenuation coefficient.

The neutron beam is produced either by fission in a nuclear reactor or by spallation, a process in which a highly-accelerated particle (e.g., proton) beam hits a heavy metal target from which neutrons are emitted due to the excited nuclei. Unlike X-rays, when a neutron beam hits the investigated material it interacts with the nucleus. The Lambert-Beer-law is also valid for the transmission of material. While with X-rays, the attenuation coefficient of materials increases with the amount of electrons in the shell, i.e. with the atomic number in the periodic system, interaction with neutrons varies nonuniformly and depends on the particular element or isotope [10]. For a neutron

beam, it is easy to penetrate heavy elements such as lead, whereas hydrogenous material such as wood and water are highly attenuating, showing the complementarity in comparison to X-rays.

Since both imaging techniques have to interact with matter, calling them “non-destructive” is only partly true. There are some cases in which an examination with one of the techniques can cause changes in the material. In the case of X-rays, the ionization effect can cause material changes [11]. For example, gemstones and glass can change colour under certain conditions. Also, information for thermoluminescence dating of pottery can be deleted [12]. When neutrons are interacting with the atomic nuclei, it happens that the nucleus captures the neutron. This changes the isotopic status which can mean a radioactive activation of some materials. After exposing the object to the beam, the isotopes degrade again depending on their half-time-period. For cultural heritage objects, this can mean that the object has to be stored in a ray-proof environment for a while. Activation can affect several materials used in musical instruments, such as silver, gold and also the tin found in bronze. It is worth mentioning that both effects—ionization and activation—can also be used as detection methods for trace elements, e.g., X-ray fluorescence (XRF) or neutron activation analysis (NAA).

2.2 Computed Tomography – Essentials

Both imaging techniques fulfil the requirements concerning the interaction between beam and sample for use in computed tomography (CT). This imaging method records a high number of single 2D radiographs at different angles which are used to compute tomograms, i.e. slice images, containing in depth and thus 3D information of the structure and content of an object. This 3D volume allows one to look inside the bodies of instruments and into the inner structure of the material. Construction details and tool marks can be detected, cracks and other damages at hidden parts can be visualised, and measurements can be taken at any (otherwise inaccessible) location with high precision. The 3D data set can even be used for replication via 3D printing or CNC-milling. 3D-CT is currently the most powerful method for the structural examination of musical instruments. Here, only industrial and non-medical computed tomography is considered. While in medical X-ray tomography, the patient lies on a cot and the detector and source are rotating around him, the industrial setting is different. The object is placed on a rotation stage between the source and the detector. For X-ray CT, the detector is in most cases a flat panel with a fixed size, such as 40 cm x 40 cm. The setting can be adjusted to the size of the object and higher spatial resolutions are possible compared to medical CT.

X-ray computed tomography is widely used in the industrial sector for monitoring production processes by means of non-destructive

testing. The spatial resolution can be very high. In the case of musical instruments, a spatial resolution of 100 μm is usually sufficient. In the case of smaller objects or by using special detection methods, the resolution can also be better. Neutron CT is also used for industrial applications, although it is not so easily accessible, as such services are only available at a handful of research institutions with neutron sources and dedicated neutron imaging facilities. The resolution is limited to the order of tens of microns due to physical reasons, which is still enough for the examination of musical instruments.

2.3 Case Study 1: Scanning a Wooden Stringed Instrument

In order to compare the capacities of neutron and X-ray imaging for the examination of wooden instruments, a scan of a pardessus de viol made by Michel Colichon (Germanisches Nationalmuseum, inv. no. MIR782) was undertaken at the Paul Scherrer Institute (Villigen, Switzerland) using the thermal neutron imaging facility NEUTRA. The instrument was first scanned with neutron CT and then with X-ray CT at the exact same position. There are several interesting features in Colichon’s instrument that can be the reason for such an investigation, among them the fact that the belly is not carved but assembled out of several pieces of bent wood. In this case, the instrument shall represent a number of possible interrogations that can concern wooden instruments, from violins and guitars to recorders or flutes, etc. In all of these cases, the investigator might want to have detailed information about the structure of the instrument, the joints, the manufacturing process, the conservational state or dimensions, e.g. in order to measure the thickness of a top plate or the diameter of a bore.

Fig.1

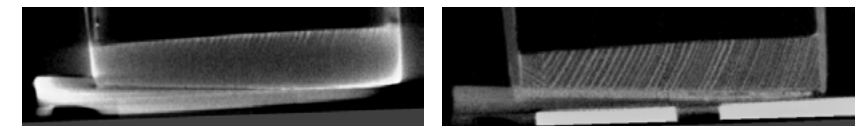

When comparing the results of both imaging methods the different qualities of transmission in the wood are quite obvious.

In a cross sections of the lower block [Fig.1], the X-ray image shows the exact orientation of the annual rings, which are (like in many instruments before 1800) parallel rather than vertical in relation to the back plate. It is also visible that the block has been assembled from two pieces with different orientations of the annual rings. The neutron image shows a brighter region at the edge of the material especially at thicker parts, the greyscale at the internal parts is much lower and no structure is visible.

Fig.1 Cross section of the lower block (left: neutron CT; right: X-ray CT).

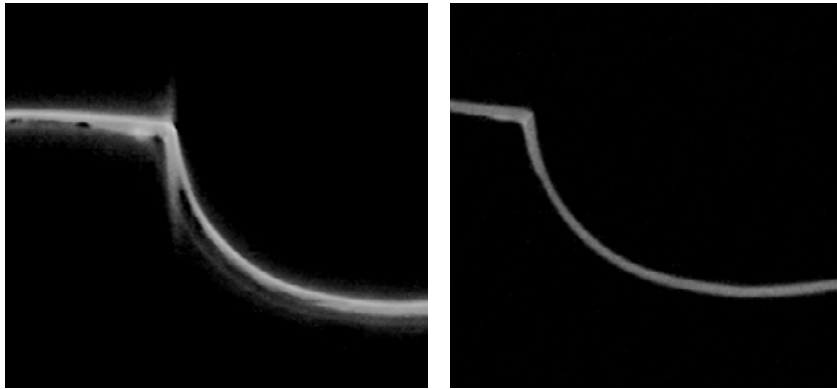
Fig.2

A cross section of the corner joints shows that not only thick parts like the lower block are not transmitted by the neutrons. In the X-ray image the bevelled joint of the corner is visible while the neutron image shows only artefacts (image errors) at the same location [Fig.2].

The painted decoration on the top plate is not shown in the neutron image. This is because of the metal pigments that were used, which cause minimal attenuation to the neutron beam and are therefore only visible in the X-ray image [Fig.3].

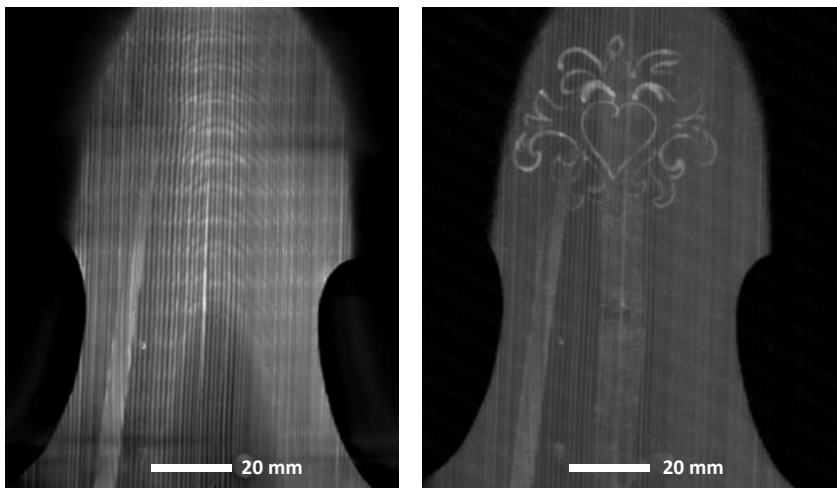
Fig.3

Despite all of its limitations in scanning wooden objects, the undoubted advantage of neutron imaging is high contrast. For example, on the inner part of the back plate, the traces of the tooth plane are visible

Fig.2 Construction of the rib joints (left: neutron-CT; right: X-ray CT).**Fig.3** Thick slice of the belly (left: neutron-CT; right: X-ray CT).

(Fig.4), whereas the X-ray image only shows a more or less uniform surface. The contrast of the annual rings is also much higher, allowing for precise analysis using techniques such as dendrochronological dating.

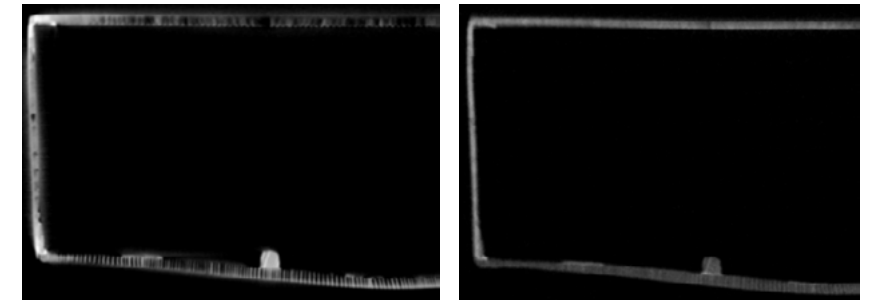
Fig.4

2.4 Case Study 2: Scanning Brass Instruments

A 3D-CT scan of a brass instrument can provide important information not only about the construction, but also measurements like the exact total length of the bore also in case of difficult geometries or the inner volume. The shape of the bore and bell can be analysed to calculate the sound quality (brassiness). Scanning a brass instrument can be challenging; the material's density is high and the construction is not simple and homogenous. Some parts, such as the walls, are quite thin while other parts, such as the valves, are very thick.

As a representative for brass instruments, a mouthpiece was scanned with neutron tomography. The scan is compared to a scan of a mouthpiece which was executed during the MUSICES-project using X-ray computed tomography. A mouthpiece is an important part of a brass instrument because it can influence the sound of an instrument and many players have their favourite examples. With traditional methods, it is difficult to measure the exact shape of the bore, e.g. for the purpose of a reproduction. In this case, the CT-data shall be examined considering three factors: first, how much information the images provide about the inner metal structure of the object; second, how exact measurements can be taken; and third, if the scan is suitable for an exact reproduction of the mouthpiece using 3D-printing or CNC-milling technologies.

Almost all brass instruments during the MUSICES-project were scanned on a CT-facility which provides a 600 kV power supply. This high energy is necessary to irradiate material of such density. The object shown here is one of the best results of a series of scanning different mouthpieces in different sizes and using different technical

Fig.4 Cross section of corpus (left: neutron-CT; right: X-ray CT).

parameters. The X-ray spectrum is polychromatic, but can be filtered to use only a harder spectrum for a better irradiation. Here a 6 mm thick copper prefilter was used.

Fig.5

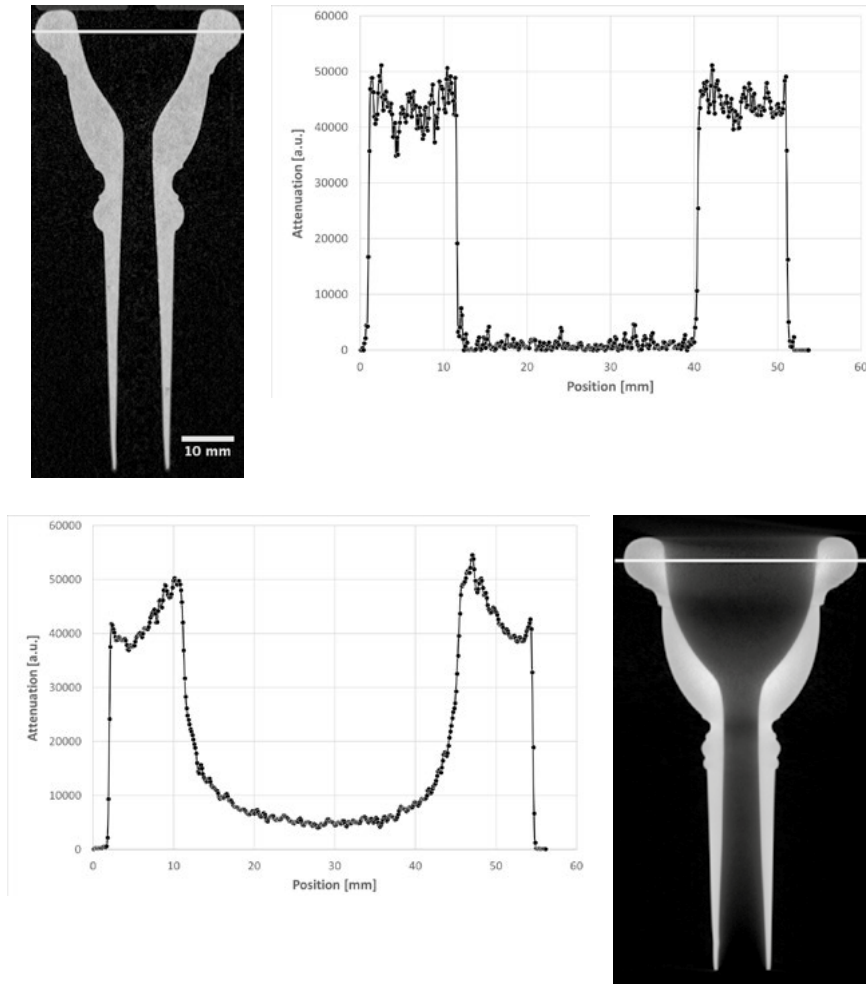

The cross section of the X-ray CT (**Fig.5**, bottom) shows on first sight a good outline of the object. The diagram visualises the distribution of the grey values. On the bottom line we see the distance and on the left axis the intensity of the grey values at every point. It shows however, that the object outline is not very sharp. The left side of the graph (where the transition from air to object is visible) shows a range

Fig.5 Above: cross sections of two mouthpieces, below: distribution of grey values in the marked line (top: neutron-CT; bottom: X-ray CT).

from lowest to highest intensity, from c. 15 pixels. Due to the setup of the CT-facility, the spatial resolution was limited to 118.4 μm voxel size. In this case it would not be easy to determine the exact surface, and therefore measurements, of the bore, for example, would always have this inaccuracy. An exact reproduction of the object that fulfils all acoustic requirements would be difficult. In the picture, it is also clearly visible that the distribution of the grey values are not homogenous. In thicker parts we find brighter areas than in thinner parts. The range of grey values in the diagram show a distribution of 100 units. Usually, this would mean that there is material with a different attenuation coefficient. In this case the difference is due to hardening artefacts. The information about the metal structure is therefore unreliable.

The other mouthpiece of similar size was scanned with thermal neutrons at the NEUTRA facility of the Paul Scherrer institute (**Fig.5**, top).

In the neutron CT-image, we see a much clearer outline of the object. In the diagram, the graph rises from zero intensity to highest intensity at a steeper pitch, and the range between the extremes on the edges is only 8 pixels. The strong differences in the diagram can be explained in large part by noise. Determining the surface is possible with higher precision compared to the X-ray scan. Here a spatial resolution of 50 μm voxel size could be achieved. Therefore measurements can be conducted and a reproduction using 3D-printing or CNC-milling technologies would be more accurate.

2.5 Case Study 3: Scanning an Instrument with Mixed Materials

Scanning objects that consist of materials with highly differing densities can be challenging. The different materials have varying attenuation coefficients. In the case of X-ray CT, problems occur for example when a wooden object has metal parts. This can be a nail in the neck of a violin or the keys of a wooden wind instrument. For the latter example, it could be a scientific issue to take measurements of the bore or to judge the conservational condition and visualise details like small cracks. Image errors such as artefacts can influence the image quality in a way that can make answering these questions difficult. For neutron imaging, the problem is the other way around. If wooden parts are too thick, they cannot penetrate.

In one experimental setup at the Paul Scherrer Institute, a flute with metal keys (German silver) was scanned twice. First, a CT scan was performed using thermal neutrons. Secondly, the object was scanned at the same position using X-rays without any prefiltering. The images can now be compared [**Fig.6**].

Both images show a cross section of the flute where a big metal key is placed. The X-ray image shows only a bright shadow of the tube and a very bright area where the metal key is supposed to be depicted.

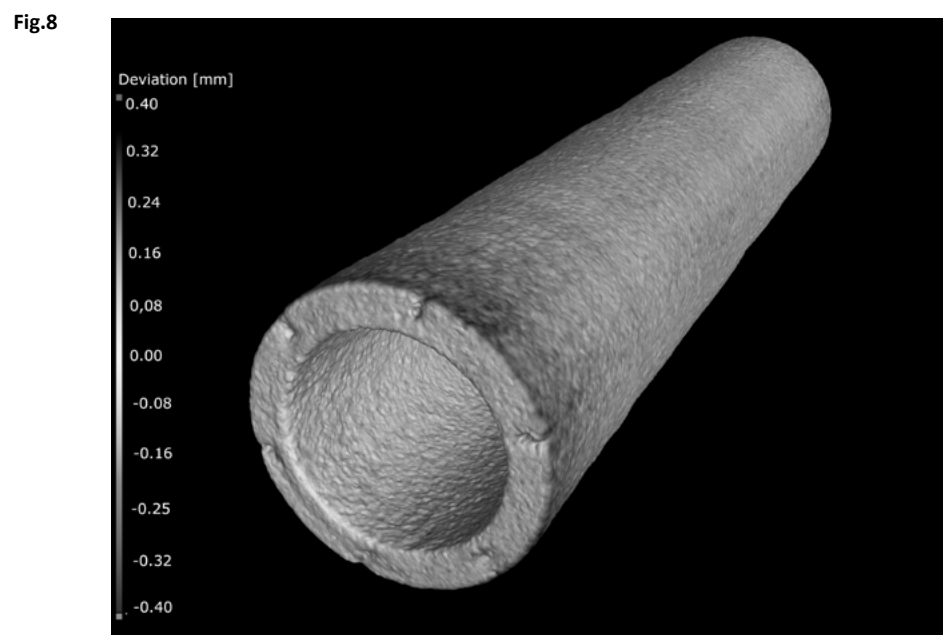
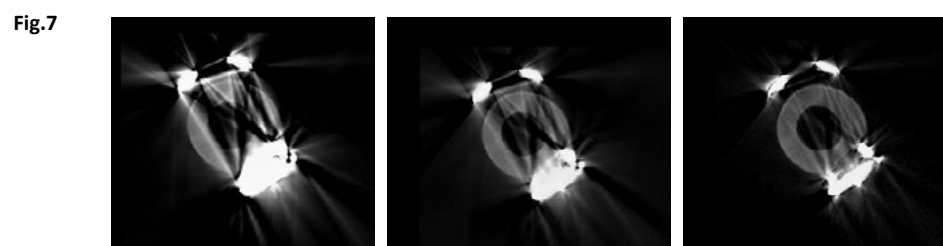
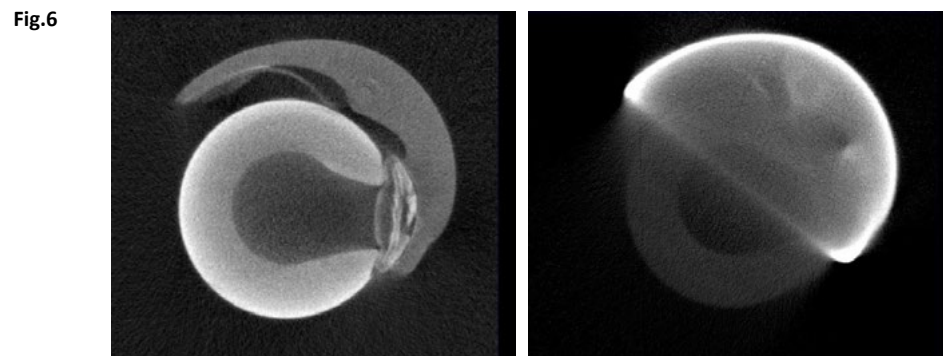

Fig.6 Cross sections of a keyed recorder (left: neutron-CT; right: X-ray CT).

Fig.7 Cross sections of a keyed cor anglais, (left: prefilter: Cu, 225 kV; centre: prefilter: Ti, 220 kV; right: combined image of both scans).

Fig.8 3D neutron image of a wooden tube sample, with deviation indicated at left.

The artefacts caused by the metal part are so strong that almost no details from the wooden part or of the key's construction are visible. The neutron image shows the constructional parts of the area in much more detail. The bright ring around the tube is caused by hardening artefacts, but details such as the angle of the tonehole opening or even the soft material between the tonehole and key are visible. Measuring the exact diameter of the bore is difficult because of the high noise. Depending on the organological or technological issue being explored, the neutron image provides much more information than the unfiltered X-ray CT.

As far as X-ray CT is concerned, a so called microfocus tube has to be used when high resolution is required. At the present time, this limits the possible tube voltage, with the result that metal artefacts will occur. In order to achieve a sufficient quality of mixed-material objects, a more elaborated scanning technique has to be used. With a combination of different X-ray spectra, metal artefacts can be reduced.

During the MUSICES project, a couple of experiments for enhancing the image quality for instruments containing of mix materials were undertaken [13]. The example shown here is a cor anglais (inv. no. MIR 396) which was scanned with two different spectra. First it was scanned with 220 kV tube voltage and a 0.89 mm Titan prefilter. In a second scan, a higher voltage of 225 kV was applied in combination with a 2.5 mm Copper prefilter. While the single reconstructions still show a lot of artefacts, the combination of both is capable to reduce them significantly [Fig.7].

2.6 Case Study 4: Water Content in Musical Instruments

The following example and more quoted experiments shall outline the capacities of neutron imaging for the determination of water content in musical instruments. According to the experiments done by Ilona Stein [14] on the moisture content in woodwind instruments, the experimental setup at the Paul Scherrer Institute should take advantage of the fact that a small water film can be made visible with neutron imaging. Two sample tubes made of maple in a size of c. 73.3 mm length and 16.6 mm diameter were scanned dry, then wetted and scanned again. One of the tubes was oiled beforehand with linseed oil; the other tube was not treated. To wet the tubes, a wet cloth was put into the bore for about ten minutes. The oiled tube absorbed only a small amount of water (0.06 g), and the untreated tube absorbed more (0.41 g). As the amount of water absorbed by the wooden (and thus highly attenuating) samples was relatively low, and due to the fact that most of the water evaporated from both tubes during the measurement, it was not possible to visualise the water directly. But what could be made visible was the dimensional change due to swelling, with higher moisture content in the untreated tube [Fig.8]. In the tangential direction of the wooden tube, an expansion of 0.36 mm was registered, equal to 2.17 percent. Even if the

water could not directly be made visible, the results show the impact of water on an untreated tube and outline the dangers of playing dry or untreated woodwind instruments.

Recently, more studies have emerged using neutron imaging for the visualisation of moisture content in musical instrument. One shows how effective varnish can be as barrier for moisture sorption in wood [15], and has thus demonstrated a more successful experimental setup than the tube experiment presented above. How powerful neutron imaging can be applied to show the moisture content in played brass wind instruments is demonstrated in a cooperative study of several institutions in Switzerland [16]. In this three-year project, it was possible to show how the moisture in the player's breath is distributed in the brass instrument and how effective are different methods for removing the moisture after usage. Finally, the corrosion on the inner surface of the bore could also be made visible. Since the water content in musical instruments plays an important role in concepts relating to conservation and playability, neutron imaging has high potential for further applications in this field.

3. Conclusion

Neutron and X-ray imaging techniques can be used for specific scientific issues concerning the examination of musical instruments. X-ray CT has many qualities when objects of materials with low densities are examined. Wooden instruments such as stringed instruments or recorders without keys can be depicted in very high quality with high spatial resolution, allowing details on construction, production, damage, dimensions, etc. to be visualised and analysed. The data can be used for reproduction with techniques such as 3D-printing or CNC-milling. When objects also contain metal parts, X-ray CT faces its limitations, and more elaborate techniques such as high-energy CT or dual-energy CT have to be used.

Neutron CT imaging is a very specific method and can be used for the examination of metal objects. Compared to X-ray CT, much more information is visible even in the case of high wall thicknesses, as in the case of a mouthpiece. The fact that water can be visualised is an undoubted advantage of this technique. This application has high potential for further research in the field of conservation and material studies. A positive result of the experiments presented is that mixed-material objects can be depicted using neutron imaging without too many artefacts. As a further result of the experiments at the Paul Scherrer Institute, a reproduction of one of the mouthpieces scanned with neutrons was successfully produced using different 3D-printing technologies.

Since X-ray CT is widely used in industrial material testing processes, access to facilities is easier than for neutron imaging facilities, which are only available at a handful of research institutes worldwide.

The fact that some materials are activated by the neutron beam can be a problem for the examination of cultural heritage objects and is thus another limiting factor. However, both techniques provide complementary features for the various scientific issues on musical instruments.

ACKNOWLEDGEMENTS: The research at the Paul Scherrer Institute was made possible by a STSM grant from the Cost Action FP1302 WoodMusICK programme (COST-STSM-FP1302-33359). I gratefully acknowledge the MUSICES team, Ilona Stein in Nuremberg for providing two of her wooden test specimens, and Lidia Chang in Boston for important help with the English text.

References

- [1] A. Faber, "Eine neue Anwendung der Röntgenstrahlen," in *Die Umschau: Forschung, Entwicklung, Technologie*, vol. 18, pp. 246–253, 1914.
- [2] E. Halfpenny, "The English 2- and 3-keyed hautboy," in *Galpin Society Journal*, vol. 2, pp. 10–26, Mar. 1949.
- [3] F. Hellwig, "Die röntgenographische Untersuchung von Musikinstrumenten," in *Maltechnik*, vol. 2, pp. 103–115, 1978.
- [4] A. Beck, "Bildanalyse in der Kunst," in F. H. W. Heuck and E. Macherauch, Eds., *Forschung mit Röntgenstrahlen. Bilanz eines Jahrhunderts (1895-1995)*. Berlin: Springer, 1995, pp. 609–623.
- [5] K. Martius, "Computertomographie und ihr Einsatz in der Dokumentation von Musikinstrumenten," in *Arbeitsblätter für Restauratoren*, vol. 25, no. 1, 1992, pp. 129–134.
- [6] O. Peter, "Neutronen-Durchleuchtung," in *Zeitschrift Naturforschung Teil A*, vol. 1, 1946, pp. 557–559.
- [7] J. Banhart *et al.*, "X-ray and neutron imaging – Complementary techniques for materials science and engineering," *Int. Journal of Materials Research*, vol. 101, pp. 1069–1079, 2010.
- [8] G. Festa, *et al.*, "Neutrons and music: Investigation of ancient flute musical instruments," *Nuclear Instruments and Methods in Physics Research B*, vol. 336, p. 63–69, 2014.
- [9] G. Festa, D. Mannes and A. Scherino, "Neutrons unveil secrets of musical instruments," in G. Festa and N. Kardjilov, Eds., *Neutron Methods for Archaeology and Cultural Heritage*. (n.p.): Springer International, 2014, p.53–66.
- [10] K. W. Herwig, "Introduction to the neutron," in I. S. Anderson, R. L. McGreevy and H. Z. Bilheux, Eds., *Neutron Imaging and Applications. A Reference for the Imaging Community*. (n.p.): Springer US, 2009, pp. 3–12.
- [11] S. O'Connor, "Assessing the risks of X-radiography to textiles," in S. O'Connor *et al.*, Eds., *X-Radiography of Textiles, Dress and Related Objects*. Oxford: Elsevier Butterworth-Heinemann, 2007, pp. 91–95.
- [12] M. Haustein *et al.*, "Influence of radiation used by security control at airports on the TL signal of quartz," in *Ancient TL*, vol. 21, no. 1, pp.7–10, 2003.
- [13] R. Wagner *et al.*, "Dual-energy computed tomography of historical musical instruments made of multiple materials," in *Proc. 8th Conf. on Industrial Computed Tomography*, Wels, Austria (iCT 2018).
- [14] I. Stein, "Blasfeuchte in Holzblasinstrumenten. Vorgänge und Risiken für das Holz," in F. Hellwig, Ed., *Studien zur Erhaltung von Musikinstrumenten Teil 1: Holzblasinstrumente, Firnisse*. Munich: Seigl, 2004, pp. 9–121.
- [15] S. Lämmlein, F. Schwarze, I. Burgert and D. C. Mannes, "The varnish barrier effect on the sorption properties of wood based on neutron imaging measurements," in P. Vandervellen, Ed., *Preservation of Wooden Musical Instruments Ethics, Practice and Assessment. Proc. 4th Annual COST FP1302 WoodMusICK Conf.*, Brussels, 2017, pp. 157–160.
- [16] A. v. Steiger *et al.*, "To play versus to display: Historische Blasinstrumente im Spannungsfeld zwischen Konservierung und Nutzung," in *Glareana*, vol. 64, no. 2, pp. 4–18, 2015.

Three-Dimensional Computed Tomography Scanning of Musical Instruments

FRANK P. BÄR (1), THEOBALD FUCHS (2), SEBASTIAN KIRSCH (1), REBECCA WAGNER (2), GABRIELE SCHOLZ (2), CHRISTIAN KRETZER (2), RICHARD SCHIELEIN (2), GUIDO BRENNHÄUSSER (2), MICHAEL BÖHNEL (2), NILS REIMS (2), MARKUS EBERHORN (2), TOBIAS KOPPERS (2), MARKUS RAQUET (1), MEIKE WOLTERS-ROSBACH (1), KATHRIN FISCHIEDL (1), SARAH WAGNER (1), MARKUS ZEPF (1)
(1) Germanisches Nationalmuseum, Nuremberg, Germany
(2) Fraunhofer Institute for Integrated Circuits IIS, Development Center X-ray Technology EZRT

Abstract

Modern research on historic musical instruments depends largely on the insight in constructional features and precise measurements of their interior structure, which in most cases is difficult to access or not accessible at all without high risk of damaging the object. Three-dimensional computed tomography (3D-CT) has become a privileged examination method for historic musical instruments from the early twenty-first century on. This article provides a short history of 3D-CT for musical instruments and condensed guidelines and recommendations for optimized technical parameters of 3D-scanning, best practice recommendations for handling and scanning musical instruments, and outlines of a dedicated metadata model to stock and retrieve the accumulated information, as they were developed in the research project MUSICES funded by German Research Foundation (DFG) from 2014 to 2017.

1. Introduction

Historic musical instruments are a promising touchstone for developing the three-dimensional CT-scanning (3D-CT) of cultural heritage objects. Research on these assets often depends on the knowledge of interior structures that are either hidden from view or not accessible for conventional measuring methods without the risk of damaging the fragile objects. From a generic point of view, there is barely another class of objects that provides a comparable multitude of different materials, forms and sizes. While the latter point is a challenge for 3D-CT technology, the first is a chance to achieve better insight into the objects' structure and thus to advance research in the field of musical organology. Within the DFG-funded research project MUSICES (MUSical Instrument Computed tomography Examination Standard), the project partners performed CT scans of a large variety of musical instruments [Fig.1]. Based on these scans, they have developed recommendations for an efficient, high-quality CT-examination workflow that complies with common standards in conservation and can, with few modifications, be applied to most other types of cultural heritage objects. The freely available "Recommendations for the Three-Dimensional Computed Tomography of Musical Instruments and Other Cultural Artefacts" [1] provide, together with the project website, a comprehensive reference guide, of which this text offers a summary of the main subjects.

2. 3D-CT of Musical Instruments in the Past

After a pioneer attempt in 1949 [2], the first publication about systematically using conventional radiography for musical instruments appeared in 1978 [3]. The method became increasingly widely used, and the first musical instrument collection catalogue using X-ray-technology was published in 1994 [4]. Shortly before, in 1992, the first experiences with medical CT scanners for musical instruments had been reported [5], and, given the limits of medical scanners for some materials and their combinations, industrial 3D-CT was successfully tested in 2005 on a recorder [6]. This technology was introduced on a broader base in collection catalogues first in Florence in 2009 [7] and then in Vienna in 2011 [8]. Since then, 3D-CT has been more and more widely used in examining and cataloguing musical instrument collections (for an overview of examination methods, see [9]; for more research related to this technology, see [10, 11] and chapters herein by Piasentini and Kirsch).

3. Measuring Precision and Areas of Interest

To determine the geometrical measuring precision commonly required for research on musical instruments within the MUSICES project, an

Fig.1



in-depth study on 19 representative collection catalogues (internal document) has been carried out, followed by a survey of 84 catalogues issued over the past 50 years [9]. As a result, in general, an accuracy of 0.1 mm is considered as sufficient, which translates into a required spatial resolution for 3D-CT-scans of better than 100 μm . The methods applied during the project typically yielded this or even higher resolutions. For purely qualitative examinations without the aim of measuring, lower resolutions as provided by medical scanners can be sufficient (see below, section 4).

4. Industrial CT vs. Medical CT for Musical Instruments

As stated above, medical CT, as its objective is the examination of the human body, has some disadvantages if applied to musical instruments. For instance, the acceleration voltage, the radiation level and the spatial resolution may be insufficient for the required metrological precision and the combinations of materials. The size of the objects may exceed the maximum receivable size of a medical scanner, and not all technical parameters may be retrievable for documentation in the metadata model (see section 6) due to operational secrets of the manufacturer.

Fig.1

Photographs and reconstructions of CT scans of a few objects from the collection of GNM examined during the project MUSICES. Top row: Box trumpet DNgnm_MI205, metal bass clarinet (Bimbonclarino) DNgnm_MIR482, oboe DNgnm_MIR375. Bottom row: Violin DNgnm_MIR809, square piano DNgnm_MIR1145.

Fig.2

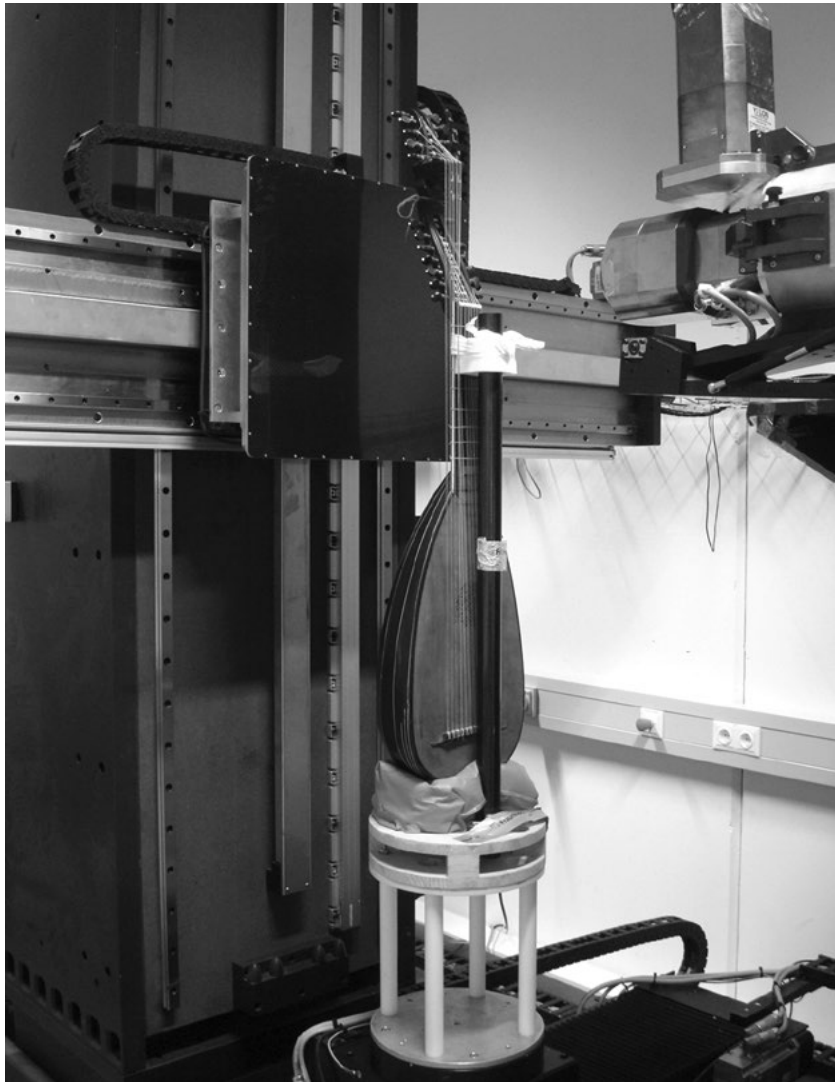

On the other hand, medical CT is a widespread technology, fast (scan and reconstruction are finished within a few minutes), and easy to handle for trained personnel in hospitals or practices. Industrial CT overcomes the mentioned deficiencies, but is relatively slow (scan and reconstruction can take several hours, since the physics of X-ray imaging in three dimensions time increases with the third power as the spatial resolution element decreases), less widespread and thus, generally more costly.

Fig.2 A lute by Sebastian Schelle (DNgnm_MIR902) prepared for scanning on the multifunctional mounting system.

During a medical CT, objects rest on a CT bed while source and detector rotate around it. In contrast, industrial CT requires a stable mounting system to position the object in an upright orientation on a rotary table between the source and the digital detector array (see [Fig.2]).

In examining a musical instrument, if a choice of method has to be made, generally speaking medical CT can be used for qualitative research on smaller objects composed of parts of lower density, e.g. wooden objects without metal parts. Industrial CT is the better choice for musical instruments with higher density materials (e.g., brass instruments) or combined materials, and for large objects. If, for quantitative research, precise measuring is important, industrial CT should be chosen regardless of the kind of object (see above, section 3).

5. Handling of Cultural Heritage Objects

Most institutions preserving cultural assets do not possess a 3D-CT-scanner on their premises. The objects therefore have to be transported to locations that have not been constructed to fulfil common museum conditions for conservation (around 50% relative humidity at around 20°C).

A CT examination campaign has to be prepared carefully. Transport and object insurance have to be organized as in every other case of object relocation. It should be ensured that the climatic conditions in the CT facility can be adjusted as well as possible to the requirements of the object for the time of the scan, which should nevertheless be kept as short as possible as a precaution, because taking an object from a museum into a different environment is always subject to risks. The preparation of a scan includes described the physical appearance of the object, i.e. size and materials have to be recorded and documented in an object description form, which can be given to the operator of the CT facility. The object weight should also be mentioned, especially for large and heavy items that may be placed off-centre on the rotary table for the region of interest for the scans. If there are metal parts such as strings or keys that can be removed, it should be considered to remove them for the measuring campaign.

To enable a satisfying scan result, the mounting of the object has to be provided by the conservators according to some requirements. For a stable and safe mounting, conservational approved materials have to be used. Only structures free of metal should be considered in order to avoid image errors such as metal artefacts. The whole setup has to be as small as possible and absolutely stable at the same time. During the MUSICES project, a multifunctional mounting system was developed which can be used for different types of objects [Fig.2].

A carbon fibre tube can be fastened vertically in a wooden base. The base has holes at various positions to plug into the tube. The object can be fastened to the tube using Tyvec® stripes or a cotton strap to secure it.

Plastic foam (e.g., hard foam, Styrodur® or Ethafoam®) can be used as a spacer between tube and object. For complex object geometries, a vacuum surgical cushion is a good solution to build a stable base. For very small or very big instruments, individual solutions have to be found. During the whole measurement campaign, all object manipulations have to be supervised by a conservator. More detailed descriptions and a construction suggestion for a mounting system can be found in the MUSICES Recommendations [1].

6. Metadata

As for all digital assets, structured metadata is of crucial importance for 3D-CT scans of musical instruments. Properly structured and assigned metadata serves to find and retrieve projection data sets and reconstructed images. Further on, the documentation of technical data permits to repeat examinations and to better find ways of executing scans for comparable objects. In principle, the metadata model developed during the MUSICES project reproduces the typical workflow for the 3D-CT examination of a musical instrument with its three main work areas: object description, CT-measurement, and reconstruction and evaluation.

All groups of data are linked by an object ID that is composed of the ICOM-CIMCIM siglum for musical instrument collections [12] and the object's inventory number, e.g. "DNgnm_MI1234" (= object No. MI1234 in Germanisches Nationalmuseum, Nuremberg). Through the entire process, this ID is progressively enhanced and completed by references to the different steps undertaken, e.g., DNgnm_MI419_20150918_FUERTH_FHGEZRT_M03_VOI1_R01 is the ID of the first (or only) reconstruction of the third measurement, which covered a volume of interest of the object MI419 of Germanisches Nationalmuseum, Nuremberg, this measurement being undertaken on 18 September 2015 in Fürth at Fraunhofer Development Center X-Ray Technology EZRT.

6.1. Work Area 1: Object Description

The Object Description contains all relevant information about:

- basic administrative data, such as owner/proprietor, inventory number, object name, maker, place and date of manufacture, basic materials, classification, size, literature, etc.
- definition of a volume of interest if the object shall not be entirely scanned, with precise indications about the area concerned
- X-ray relevant features, with regard to the form, critical combinations of materials, movable parts, overall dimensions including the supporting structures or enclosing container, tilt angle etc.
- conservational requirements, as method of packing and transportation, advices for handling and climate control

- the scientific issue(s) with information about the aim of the examination (construction details, printed replica, etc.) and the required spatial resolution.

6.2. Work Area 2: Measurement

This work area contains all relevant information about:

- documentation of the digital data acquisition, partially mirroring and completing the object description in Work Area 1 above, with starting date of the CT scan, the actual handling of the object (e.g., strings removed), the actual climate conditions and the inclusion of reference items or image quality indicators (e.g., ball bars, see also section 7.1) in the measured volume
- parameters regarding the projection data set, as X-ray tube current and voltage, pre-filters, X-ray focal spot size, exposure time, trajectory, magnification factor, positioning of the object, etc.
- the archiving of the projections: location, format and medium of the data storage
- documentation of the scanning process with information about the starting time, duration and the operator of the measurement, the applied radiation dose and the resulting data volume of the projection data.

6.3. Work Area 3: Reconstruction and Evaluation

This work area contains all relevant information about:

- the reconstruction data set, such as the reconstruction method and parameters, important corrections, the voxel number and size, padding and binning
- edited reconstruction data sets, if appropriate, e.g., if empty space is clipped to reduce the size of the data set
- evaluation and visualization, where on one hand the reconstruction of a test specimen is checked against the original measurements, and on the other hand a verbal assessment of the visual quality is documented.

6.4. Common Acquisition Fields

The acquisition fields of the three main work areas as detailed above contain device-independent data so that in principle a measurement can be reproduced on any facility that provides the same parameters. The "common acquisition fields" part of the metadata model documents the very parameters of the X-ray devices that have been used, i.e., about the system of mechanical axes specific to the particular facility as well as the X-ray source and the detector, including the type and the serial number of the devices. When using medical scanners, it may be impossible to provide these data due to the manufacturer's corporate non-disclosure policy.

7. Computed Tomography of Musical Instruments

The actual CT scan and the choice of the associated parameters will be executed by the operator of the CT facility. Nevertheless, a basic understanding of technical dependencies is useful also for owners of musical instruments considering a scan of their object.

7.1. Items to Scan With the Object

There are various reasons to commission a CT scan of a musical instrument. For some of them it is useful to include other items in the scan volume. One frequent aim of CT scans is the possibility of obtaining geometrical measurements of characteristic features like the diameter of the bore in a wind instrument or the thickness of the wood forming the corpus of a stringed instrument. In such cases, a calibrated length scale should be scanned with the actual object. One option is ball bars. They are typically made of two or three balls of ceramics or ruby that are connected by a bar of carbon fibre. The distance between the centres of the balls is known with very high precision. Ball bars are preferably placed close to the object, so as not to increase the dimension of the setup, but avoiding contact with it. It should also be avoided to place them at positions where artefacts, for instance due to metallic parts, are expected to distort the reconstruction.

Occasionally, determining the density of various parts of an instrument can be of interest, for instance as an input parameter for acoustical simulations. The grey values in a reconstructed CT data set represent the attenuation coefficient of the corresponding material. At a given X-ray energy, this parameter is depending on the materials' chemical composition and on its mass density. There is a linear relation between density and attenuation coefficient for materials with similar chemical composition. In some cases, this provides a simple opportunity to extract the density from a reconstructed volume data set.

Most species of wood, for instance, have similar chemical compositions [13]. It is thus possible to select reference samples covering a wide range of known densities, such as balsa, pine and ebony, and include them in CT scans of wooden objects to simultaneously obtain a calibration curve [Fig.3]. This can then be used to obtain the density of wooden parts.

The same approach is possible for other materials that come with similar chemical composition but different density, such as plastic or ivory. When an object or a part thereof is assumed to be made of one of several materials, reference samples of these materials can be scanned together with the object. The comparison of the grey values can then help to identify the materials.

In general it is recommended to include any reference items in the actual scan of the object of interest. This ensures that all parameters and conditions are identical. Scanning object and reference one after the other

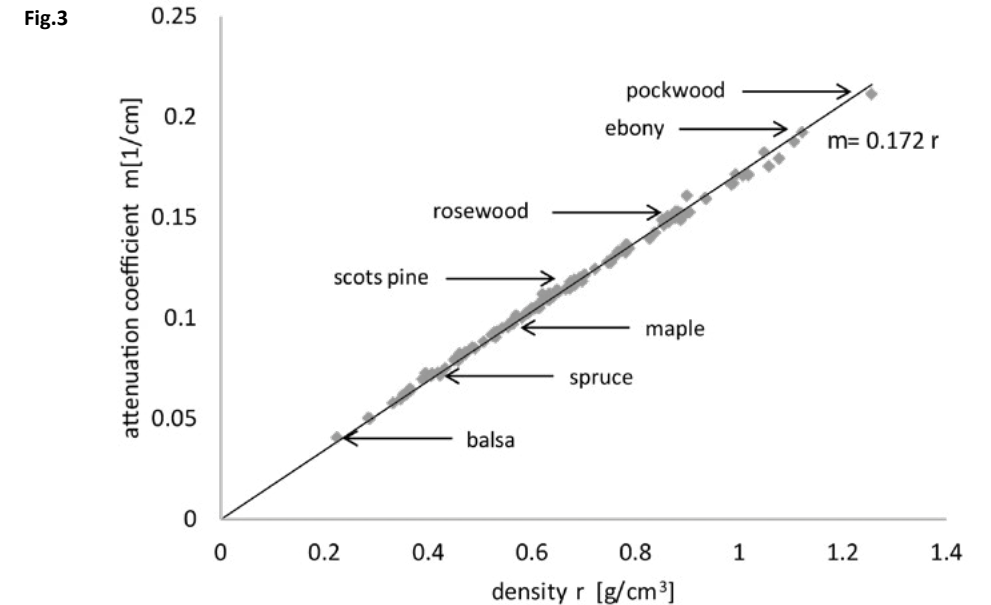

Fig.3 The analysis of CT scans of 120 wooden blocks from a xyliarium shows a linear relation between the reconstructed attenuation coefficient μ and the density ρ of the blocks. Thus, scans of reference samples of known density with an object of interest allow to create a calibration curve that can be used to determine the density of unknown wooden parts.

comes with the risk of accidentally modifying parameters between the two scans. Especially when longer time periods pass between the scans, comparability might not be ensured since industrial CT systems can be subject to change. Changes in the climatic conditions may modify the moisture content of wood which in turn influences the measured grey values [14].

7.2. Manipulation of Objects in CT Facilities

Industrial CT facilities can provide various options to change (by remotely controlled motors) the positions of the X-ray source and detector as well as the object under investigation. This allows, for instance, the magnification to be adjusted or the use of various different scan trajectories (see section 7.3). It also creates the risk of collisions between a valuable object on one hand and an expensive machine on the other hand. This risk increases with decreasing distances between the object and the components of the CT system.

Consequently, special care has to be taken when the freedom of movement becomes restricted, for instance when scanning large objects. In such cases, the planned handling operations can be tested

in a dry run with a dummy. Recording all parameters verified in this way using a checklist is helpful. The parameters should be tested with the actual object as well. To this end, it is advisable that one person watches the movements from within the facility (with radiation turned off, of course). This person has to be able to communicate with the operator of the handling system, by telephone, for instance, in order to be able to order immediate stoppage of all movement. If immediate danger is detected, the emergency shutdown should be used.

Following the “four eyes principle” is preferred over the observation of handling operations solely by cameras. Although these are useful as an additional control and for observations during the actual scan, they can lead to misinterpretation due to perspective distortions.

7.3. The Choice of Scan Trajectory

When doing industrial CT, there are various possible trajectories, i.e. paths along which the source can move in the perspective of the object. Each choice of trajectory has advantages and disadvantages.

The simplest one is a circular CT, which is typically realised by rotating the object, while source and detector remain stationary. This method can be used to acquire projections of the complete object only if it is small enough, i.e. smaller than the digital detector array, which is typically 40 cm × 40 cm. Otherwise projections will be truncated and only the reconstruction of a region of interest can be obtained.

For objects too long to be projected onto the detector completely, like recorders, there are two possibilities. One is the vertical stacking of several circular CT scans. Between these scans, either the object or the source and the detector are shifted vertically. Consecutive scans can be recorded either with or without overlap in vertical direction. When working without overlap, the reconstructed volumes can simply be concatenated. This is possible only if the object was not reoriented between scans. Working with overlap has the advantage that an object can be repositioned between scans. For instance, it can be turned upside-down if it is too long for the facility to handle otherwise. In this case the reconstructed volumes have to be registered, which requires the presence of suitable structures in the object. If these are not available, some artificial structures can be attached to the object, for example plastic beads embedded in ethafoam. In either case, the combination of scans can result in visible transitions between adjacent volumes. Hence, care should be taken in advance that these transitions are not situated in object locations of particular interest.

Helical scans are a different opportunity for long objects. In this case the rotation of the object and the vertical shift are executed simultaneously, which is technically more demanding and not feasible with every CT-system. A later combination of reconstructions is not needed with

helical CT-technique. In addition, the method avoids cone beam artefacts that are detrimental to image quality when applying circular scan trajectories [15]. Especially when there are thin structures perpendicular to the axis of rotation, like drumheads, helical scans improve image quality [Fig.4].

Fig.4

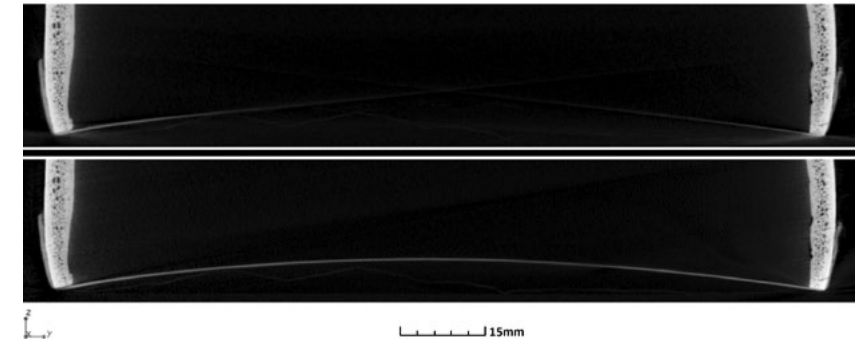

Objects slightly too wide to be imaged onto the matrix detector in their entirety can be scanned with laterally displaced sensor device. This method is applicable if a horizontal shift of the detector by less than half of its width is sufficient to obtain projections that are not truncated on one side. Although information is missing, the reconstruction of the full diameter of the object is possible.

For wider objects, measurement field extension can be applied. For this method, CT scans are recorded for two or more horizontal detector positions. The projections obtained in this way are combined to wider images, similar to panoramic photographs. As the number of projections required per 360° scan is proportional to the diameter of the field of measurement, an extension thereof is associated with an increase in scan time and applied dose.

The aforementioned methods can also be combined. This is of advantage especially for objects with a diameter that varies along the vertical direction. For instance, the corpus of a viola da gamba might be scanned using measurement field extension, while the neck can be recorded using a helical scan. In this way, scan time and dose are reduced.

A considerably different type of trajectory is represented by laminography [16]. While the object remains stationary, source and detector are moving in planes parallel to it. This method is suitable for flat objects that cannot be rotated, for instance due to their size. It also limits the

Fig.4

Cross sections through the drumhead of a damaru (inventory number 2310, Museum für Musikinstrumente der Universität Leipzig). (a) Using a circular trajectory, the drumhead is not visible completely due to cone-beam artefacts. (b) The image quality is improved when applying a helical scan trajectory.

risk of collisions. However, projections are recorded only from a limited range of angles. As a consequence, the visibility of object structures depends on their orientation. For example, when looking for cracks in the pinblock of a grand piano, they would be detected more easily when oriented perpendicular to the detector plane as compared to parallel to it.

7.4. Reduction of Metal Artefacts

For scanning objects of low density materials such as wood, micro-focus X-ray tubes are preferentially used to achieve high spatial resolution. These tubes typically allow for acceleration voltages of up to 225 kV. While soft X-ray spectra have the advantage of providing better contrast of wooden structures, such as growth rings, in comparison to harder spectra, they do not transmit through metal as well. Thus, when using soft spectra for objects of mainly low-density materials that contain some metal parts, artefacts may deteriorate image quality significantly (**Fig.5(a)** and **Fig.5(b)**). To avoid them, it is advisable to remove as much metal as possible.

A different option is to use higher tube voltages. However, this leads to lower contrast. Further, high-kV micro-focus tubes are not easily available yet and using a large focal spot is detrimental to the achievable spatial resolution. Thus, the decision for the actual tube voltage depends on the technical capabilities and on the requirements for answering all organological questions.

A further approach is the use of dual-energy methods [17, 18, 19, 20]. These techniques necessitate two CT scans with different X-ray energies. As the energy dependence of X-ray attenuation differs between different materials, the second scan yields additional information. The subsequent combination of both scans reduces metal artefacts [**Fig.5c**]. One drawback is the higher absorbed dose, which is inappropriate for radiation-sensitive objects. A second is that, although there are CT facilities that record both scans simultaneously [17], this is not the typical case. Usually both scans are recorded successively. This causes a respectively increase in scan time and must be taken into account, especially for objects sensitive to climatic fluctuations.

7.5. Choosing Further Parameters for a CT Scan

Several more parameters have to be chosen carefully to ensure a good image quality in the reconstructed volume data set. Most choices are depending on multiple object properties and mutually influence each other. This section presents a concise guide to the selection of some important parameters. For a more complete treatment the reader is referred to the MUSICES Recommendations [1].

As explained in section 0, the X-ray spectrum has to be chosen according to the physical properties of the object under investigation.

Fig.5

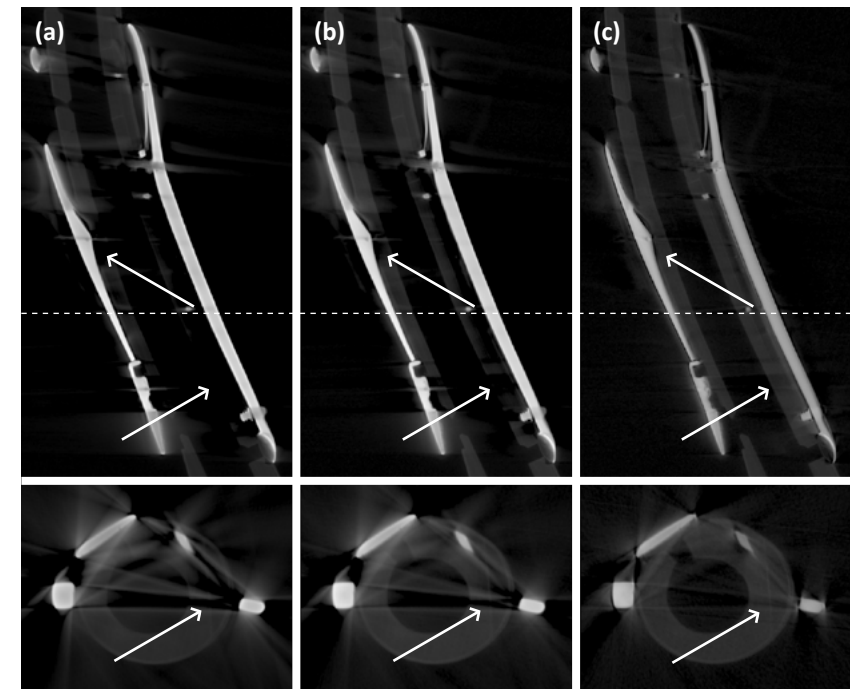

With increasing mass density and transmitted lengths it has to become harder, i.e. a higher tube voltage and stronger prefiltration is needed. As a rule of thumb, at least 10 % of the unattenuated intensity should be transmitted through the parts of the object with highest attenuation. If the spectrum is too hard, the contrast in the reconstructed images is reduced. If it is too soft, noise increases and artefacts occur.

The intensity of the X-rays emitted by the tube, and thus also the detected intensity, are proportional to the tube current and the exposure time used for recording the projections. Typically, the unattenuated intensity should be about 70 % of the detector's dynamic range. With lower intensity, the signal to noise ratio decreases. While it is desirable to use a high current to keep the scan time as short as possible, this also increases the tube power. Typically, when raising the power by 1 W the focal spot is assumed to expand by 1 μm in diameter. Thus, the desired spatial resolution can induce a limit to the applicable power.

Fig.5 Vertical (top, adapted from [21]) and lateral (bottom) cross sections through reconstructed volumes of a cor anglais (DNgnm_MIR396). The dashed line and arrows indicate the position of the horizontal cross sections and artefacts, respectively. (a) Low energy scan (225 kV, 0.89 mm Ti prefilter), (b) high energy scan (220 kV, 2.5 mm Cu prefilter) and (c) combination of both scans to reduce metal artefacts using a method described in [20].

Furthermore, there is an upper power limit that should be respected to avoid damage to the X-ray tube. Further increases in detected intensity can be obtained by using a longer exposure time. However, the total scan time should be kept within reasonable limits due to economic and conservatory reasons (see section 5).

The number of projections that are required per 360° rotation of the object depends on the diameter of the object including the mounting system. It was found that it should be approximately equal to the number of pixels the projection of the object covers on the detector in the horizontal direction. Too small a number of projections results in undersampling, which decreases the spatial resolution especially with increasing distance from the axis of rotation.

Following from what is said above, when the aim is to achieve high spatial resolution, then long overall measurement times are to be expected. Micro-focus tubes with small focal spots that set a limit to the tube power as well as digital detector arrays with small pixels have to be used. Both demand long exposure times. Also the large number of projections required to avoid undersampling may increase the total scan time. In addition, it is recommended to apply a more time-consuming stop & go procedure instead of a “fly by” mode, i.e. the object should not rotate continuously during a scan but stop for each projection to avoid artefacts caused by the motion of the object during the recording of each projection. This also permits the averaging of n projections, which reduces noise but leads to an increase in measurement time by the factor n .

8. Conclusion

Computed tomography (CT) is a non-destructive method that facilitates insight into musical instruments that could not be gained by other means without disassembling the object or risk of damaging it. While the widespread medical CT reaches only a limited spatial resolution and is suitable for quick qualitative examinations, industrial CT allows for spatial resolutions that permit geometrical measurements or even specialised examination methods such as dendrochronology. The large variety of sizes, shapes and materials (due to elaborate decorations and metallic keys or nails present in wooden instruments) poses various challenges for CT scans. These issues have to be addressed by selecting appropriate CT parameters, scan procedures and data and image processing algorithms to obtain good quality in the reconstructed volume images. Approved options documented for the examinations of 105 different instruments can facilitate the parametrisation and further processing of future scans of similar instruments. They were also used to develop recommendations

for instrument types not scanned so far. Furthermore, as the relevant physical processes are the same, these recommendations can also be applied to other cultural heritage items, such as panel paintings or clocks. This reduces the need for extensive trial and error experiments and thus saves time, absorbed dose and costs.

ACKNOWLEDGEMENTS: The MUSICES project was funded by German Research Foundation (DFG) under the grant numbers GR 1471/10-1 and HA 2904/4-1.

Valuable help and advice have been given by the German co-proposers and the international cooperation partners, whereof the co-proposers have provided access to types of musical instrument from their collection that were not represented in the Germanisches Nationalmuseum's collection: Musikinstrumenten-Museum, Staatliches Institut für Musikforschung, Preußischer Kulturbesitz in Berlin (Dr. Conny Restle, Dr. Tom Lerch); Museum für Musikinstrumente der Universität Leipzig (Dr. Eszter Fontana, Dr. Josef Focht, Markus Brosig, Jakob Kusnick, Christopher Schott); Staatliche Museen zu Berlin, Ethnologisches Museum (Dr. Lars-Christian Koch, Albrecht Wiedmann, Dana Freyberg); Muziekinstrumentenmuseum in Brussels (Dr. Anne-Emmanuelle Ceulemans, Dr. Gery Dumoulin); University of Edinburgh (Dr. Darryl Martin, [now Danish Music Museum, Copenhagen], Norman Rodger, Susan Pettigrew); and Philharmonie de Paris (Dr. Thierry Maniguet, Rodolphe Bailly).

Further contributions to the project have been made by: Vera de Bruyn-Ouboter, Ringve Music Museum, Trondheim, Norway; Jan Bouterse, Netherlands; Dr. Antonio Pelegrina Jimenez, University of Granada; Francesco Piasentini, Padua; Dr. Fabrizio Rosi, TEC Eurolab, Modena; Dr. Gabriele Rossi Rognoni, Royal College of Music, London; Dr. Giovanni Paolo di Stefano, Rijksmuseum, Amsterdam; Dr. Christina Young, Courtauld Institute of Art, London; Dr. Rudolf Hopfner, Kunsthistorisches Museum, Sammlung alter Musikinstrumente, Vienna; Dr. Hannes Vereecke, Fachschule für Musikinstrumentenbau, Ludwigsburg; and Dr. Michael Wucherer, Klinikum Nuremberg. With support from the European Community, the COST action FP 1302 WoodMusICK, directed by Dr. Sandie Le Conte (Philharmonie de Paris) and Dr. Pascale Vandervellen (Musical Instruments Museum, Brussels), has provided a scientific framework to discuss the MUSICES project and has funded the participation of most of the above-mentioned researchers at one of the project meetings.

References

- [1] F. P. Bär *et al.*, *Recommendations For the Three-Dimensional Computed Tomography of Musical Instruments and Other Cultural Artefacts*. Nuremberg: Fürth, 2018.
- [2] E. Halfpenny, “The English 2- and 3-keyed hautboy,” *The Galpin Society Journal*, vol. 2, p. 10–26, March 1949.
- [3] F. Hellwig, “Die röntgenographische Untersuchung von Musikinstrumenten,” *Maltechnik*, no. 2, p. 103–115, 1978.
- [4] M. Kirnbauer, “Verzeichnis der Europäischen Musikinstrumente im Germanischen Nationalmuseum Nürnberg,” in *Flöten- und Rohrblattinstrumente bis 1750*, vol. 2. Wilhelmshaven: Noetzel, 1994.
- [5] K. Martius, “Computertomographie und ihr Einsatz in der Dokumentation von Musikinstrumenten,” *Arbeitsblätter für Restauratoren*, no. 1, p. 138–143, 1992.
- [6] K. Martius and M. Raquet, “3D-Computertomographie,” *Windkanal*, no. 3, p. 6–12, 2005.
- [7] G. Rossi-Rognoni, Ed., *The Conservatorio Luigi Cherubini Collection. Bowed Stringed Instruments and Bows*. Florence: Galleria dell’Accademia, 2009.
- [8] B. Darmstädter, *Sammlung alter Musikinstrumente. Die Zinken und der Serpent*. Vienna / Bergkirchen: Kusthistorisches Museum, 2011.
- [9] F. P. Bär, “A curator’s dearest child – Examining musical instruments for collection catalogues,” *Journal of Cultural Heritage*, pp. S8–S16, October 2017.
- [10] N. Sodini, D. Dreossi, A. Giordano, J. Kaiser, F. Zanini and T. Zikmund, “Comparison of different experimental approaches in the tomographic analysis of ancient violins,” *Journal of Cultural Heritage*, pp. S88–S92, October 2017.
- [11] J. Van den Bulcke, D. Van Loo, M. Dierick, B. Masschaele, L. Van Hoorebeke and J. Van Acker, “Nondestructive research on wooden musical instruments: From macro- to microscale imaging with lab-based X-ray CT systems,” *Journal of Cultural Heritage*, pp. S78–S87, October 2017.
- [12] L. Libin, Ed., *The Grove Dictionary of Musical Instruments*, 2nd ed., vol. 1. New York: (n.p.), 2014, p. lix–lxxxiii.
- [13] A. Macedo, C. M. P. Vaz, J. C. D. Pereira, J. M. Naime, P. E. Cruvinel and S. Crestana, “Wood density determination by X- and gamma-ray tomography,” *Holzforschung*, vol. 56, pp. 535–540, 2002.
- [14] J. H. Fromm, I. Sautter, D. Matthies, J. Kremer, P. Schumacher and C. Ganter, “Xylem water content and wood Density in spruce and oak trees detected by high-resolution computed tomography,” *Plant Physiology*, vol. 127, pp. 416–425, 2001.
- [15] J. Hiller, S. Kasperl, T. Schön, S. Schröpfer and D. Weiss, “Comparison of probing error in dimensional measurement by means of 3D computed tomography with circular and helical sampling,” in *Proc. 2nd International Symposium on NDT in Aerospace*, Hamburg, 2010.
- [16] M. Rehak, U. Haßler and R. Hanke, “Acquisition trajectories for X-Ray tomosynthesis applied to planar samples,” in *Proc. 2nd International Symposium on NDT in Aerospace*, Hamburg, 2010.
- [17] D. Vavrik, J. Jakubek, I. Kumpova and M. Pichotka, “Dual energy CT inspection of a carbon fibre reinforced plastic composite combined with metal components,” *Case Studies in Nondestructive Testing and Evaluation*, vol. 6, p. 47–55, 2016.
- [18] L. Yu, S. Leng and C. H. McCollough, “Dual-energy CT-based monochromatic imaging,” *American Journal of Roentgenology*, vol. 199, p. S9S15, 2012.
- [19] K. S. Kim *et al.*, “Image fusion in dual energy computed tomography for detection of hypervascular liver hepatocellular carcinoma: Phantom and preliminary studies,” *Investigative Radiology*, vol. 45, pp. 149–157, 2010.
- [20] S. Kuchenbecker, S. Faby, S. Sawall, M. Lell and M. Kachelrieß, “Dual energy CT: How well can pseudo-monochromatic imaging reduce metal artifacts?,” *Medical Physics*, vol. 42, pp. 1023–1036, 2015.
- [21] R. Wagner *et al.*, “Dual-energy computed tomography of historical musical instruments made of multiple materials,” *iCT 2018: 8th Conf. on Industrial Computed Tomography*, Wels, Austria, pp. 1–6.

Application of X-Ray Computed Tomography in Diagnostics and Reverse Engineering of Bowed Stringed Musical Instruments

F. PIASENTINI (1), M. MOSCATTI (2), S. CARMIGNATO (3)

(1) Francesco Piasentini, Studio for Violin Making and Restoration, Padova, Italy

(2) TEC Eurolab, Modena, Italy

(3) Department of Management and Engineering, University of Padova, Italy

Abstract

This contribution summarizes several works on the application of industrial X-ray computed tomography to bowed stringed instruments, developed by Francesco Piasentini and TEC-Eurolab since 2014, in collaboration with the University of Padova. Some of these works were disseminated during the WoodMusICK FP1302 COST ACTION and elsewhere. This paper offers an in-depth analysis of practical aspects of CT scanning a violin with cone-beam industrial X-ray CT scanner. Examples of the effects of CT system settings are presented, including those related to X-ray tube voltage and current, detector binning and geometric magnification. Surface determination is a critical step in the dimensional analysis of CT volumes. For instance, surfaces determined using global or local thresholding algorithms can exhibit significant deviations, especially with multi-material instruments or materials showing strong variations in density, such as spruce. Investigations of CT metrology for violin tops allowed measurement uncertainties to be determined for a series of dimensions that are relevant for bowed stringed instruments.

1. Introduction

Diagnostics and reverse engineering of musical instruments are increasingly important, and their development in these areas is giving museums and scientific community new opportunities to investigate their collections and share results effectively. Industrial X-ray computed tomography (CT) plays a crucial role in this field, both to investigate the condition of the musical instrument [1, 2 and in the previous chapter of this volume] and to extract its geometrical features [3, 4]. This chapter explores the application of X-ray computed tomography to diagnostics and reverse engineering of bowed stringed musical instruments, with particular insight into violins.

Assessing the condition of a wooden musical instrument is the first step in any conservation and restoration activity [5]. As a delicate artefact made of wood, various factors can compromise its conservation and its functionality: from improper use and handling, woodworm attacks and abrupt variations in the material moisture content, to non-orthodox restorations and repairs. Evaluating the effects of these factors is a crucial aspect of preparing a condition report of an instrument. CT proves to be an effective tool in documenting evidence of damage and modifications. A multi-resolution scanner (such as the CT system used in this research) allows the analysis to be tailored to the desired level of detail and cost. In order to investigate these issues, the study summarized in section 2 hereafter presents a portion of a violin scanned at various resolutions (voxel sizes 112, 224 and 447 μm) and a results comparison.

There is increasing interest in obtaining the internal and external surfaces of musical instruments [6, 7]. The reconstructed three-dimensional (3D) geometry can be used directly to create physical copies in rapid prototyping (additive or subtractive manufacturing) or to compare features of different authors or schools for a specific instrument type. Section 3 summarizes the findings from research on the evaluation of CT as a tool for dimensional analysis of a violin soundboard. This specific part of the violin is chosen because it presents a wide range of common problems related to the dimensional analysis of wooden free-form objects like violins or other strings. To assess the results achieved by this CT application, a coordinate measuring machine (CMM) is used as reference instrument to compare the performances of an X-ray industrial CT scanner and a structured light 3D scanner (LS).

2. Scanning Bowed Stringed Instruments with Industrial Cone-Beam CT Scanners

Industrial cone-beam CT scanning needs a cone-beam X-ray source and a flat panel detector to acquire X-ray images of the scanned object, which rotates with respect to source and detector. Differently from typical

medical scanners, resolution can be changed moving the object at different distances from the detector and/or the X-ray source. When planning a CT scan of a bowed stringed instrument or a part of it, many parameters (e.g., magnification, tube voltage and current, detector acquisition parameters) need to be set, as reported also by Sodini [8, 9]. This process is performed according to the scope of the analysis (diagnostic, metrology, study of the material), the shape of the instrument and its materials. For a bowed stringed instrument (violin, viola or cello), consisting essentially of a shell-like structure made of wood, a typical work-flow is summarized here.

First, the area of analysis is chosen. This could be the whole instrument or a certain part of it. The diameter of the cylinder circumscribing the instrument or its area of interest during the revolution determines both the minimum and maximum achievable magnification for scanning the whole instrument. The minimum magnification requires the instrument to be as close as possible to the detector (see Fig.1). The maximum magnification is achieved moving the instrument as close as possible to the X-ray source with the projection of the area of analysis within the detector width.

In this research, the CT analyses were performed using a North Star Imaging NSI X5000 CT system, which allows the detector to shift laterally, in the so-called MosaiX® mode, in order to increase the effective detector size, at the cost of a longer scan time. The height of the area of analysis can be increased, for example, using a helical scan mode: both detector and tube translate in the z-direction (parallel to the rotary axis) while the instrument rotates. When combined with the detector shift, this scanning mode (VorteX®) provides the maximum magnification for a given area of analysis (see Fig.2).

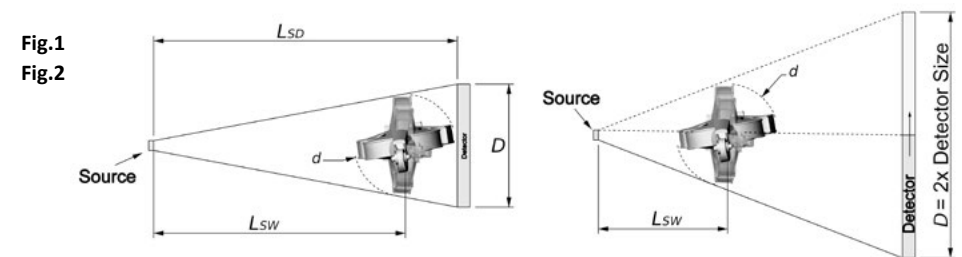

Fig.1
Fig.2

Once the instrument is placed in the scanner, a first radiography analysis highlights the presence of high-absorbing materials such as fillers and metal parts (nails, nail fragments, screws). In the absence of these features, tube voltage can normally be set within the range of 40-65 kV

Fig.1 Minimum magnification.
Fig.2 Maximum magnification.

in order to enhance the radiographic contrast (see section 2.4). Tube current can then be set as high as possible to increase the photon count in the detector, without exceeding the ratio between focal spot size and effective pixel pitch, which is critical for image sharpness (see section 2.2). Metals cause problematic artefacts in the X-ray tomography of wooden musical instruments, as reported by Bär in the previous chapter of this volume. If metal parts are present, higher energy is required to pass through them. This can be achieved for instance by increasing the tube voltage and filtering the lower part of the X-ray spectra with physical filters (e.g., copper) at the source, in order to reduce beam-hardening and scattering effects. In his comparison between X-ray and Neutron tomography (see pp.151-170 of this volume), Kirsch suggests the use of neutron radiation for imaging wooden musical instruments with metal parts (such as recorders with metal keys), as an alternative to X-ray CT.

2.1. Geometrical Magnification

The geometrical magnification of an X-ray CT system is calculated as [10]:

$$M = \frac{L_{SP}}{L_{SW}} \quad (1)$$

Where L_{SD} is the distance between the X-ray source and the detector, L_{SW} is the distance between the X-ray source and the instrument. The voxel size is related to the detector's pixel size p [μm] and the geometric magnification M according to:

$$V = \frac{p}{M} \quad (2)$$

For the square pixel VARIAN detector used in the NSI X5000 system, p is 127 μm . The maximum magnification M_{MAX} for a given instrument of diameter d (or part of it, with diameter d) and a detector with effective size D can be approximated as:

$$M_{MAX} = \frac{D}{d} \quad (3)$$

The VARIAN detector used in the NSI X5000 system measures 200×250 mm and can be used in both landscape and portrait mode. When in landscape mode, it can be also shifted laterally to provide an effective width of 500 mm, as shown in Fig.2. In this configuration, the theoretical M_{MAX} for a whole violin with a lower width of 210 mm is 2.38, corresponding to a voxel size of 53 μm .

The minimum magnification (and corresponding maximum voxel size) can be calculated as:

$$M_{MIN} = \frac{L_{SW}}{L_{WD}} \quad (4)$$

L_{SD} for the NSI X5000 system is 1060-1080 mm. For a 210 mm-wide violin, the maximum theoretical L_{SW} is 955-975 mm. Normally a distance of 930-940 mm is used, corresponding to a magnification of 1.13-1.16 and to a voxel size of 109-113 μm .

2.2. Geometric Unsharpness

The focal spot size f is the dimension of the X-ray focal spot. For a given tube, its dimension is approximately proportional to the beam power: increasing tube voltage and current increases its width. As the spot size increases and the instrument gets closer to the detector, the geometric unsharpness, U_g , increases, as visible in Fig.3, according to:

$$U_g = \frac{f \cdot L_{SW}}{L_{WD}} \quad (5)$$

Fig.3

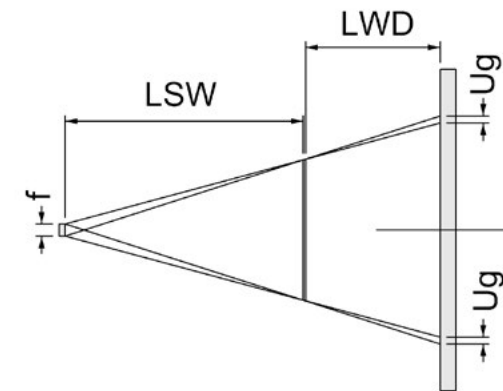

When U_g increases and approaches the detector pixel size, image quality decreases due to blurring. Therefore, instrument dimension is only one factor limiting the maximum magnification: focal spot size has to be taken into account when tuning the tube parameters and the work-piece distance from the X-ray source.

2.3. Effect of Tube Voltage on Radiographic Contrast

Increasing tube voltage reduces the image dynamic and increases noise. This can be seen in the comparison of the coronal slices in Fig.4 and fig.5 (note that grey values are inverted, with denser material represented as darker than lighter areas). Fig.4 is both sharper and less noisy, with a better representation of the wood's anatomical features. Scans were performed (on different instruments) at approximately the same voxel size: 112 and 108 mm, in helical scan (VorteX® continuous).

Fig.3 Geometric unsharpness.

Fig.4
Fig.5

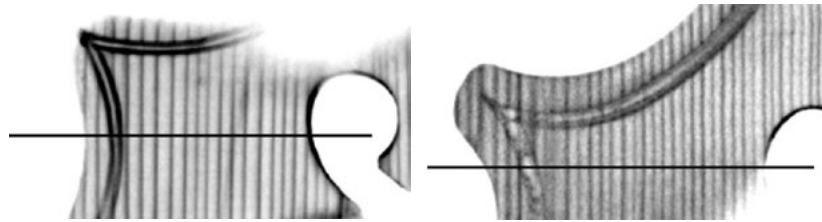

Grey values as measured along the lines reported in **Fig.4** and **fig.5** are plotted in **Fig.6**. A lower voltage gives a higher contrast between late and early wood in spruce, as well as other denser features such as purfling and material layers over the f-holes.

Fig.6

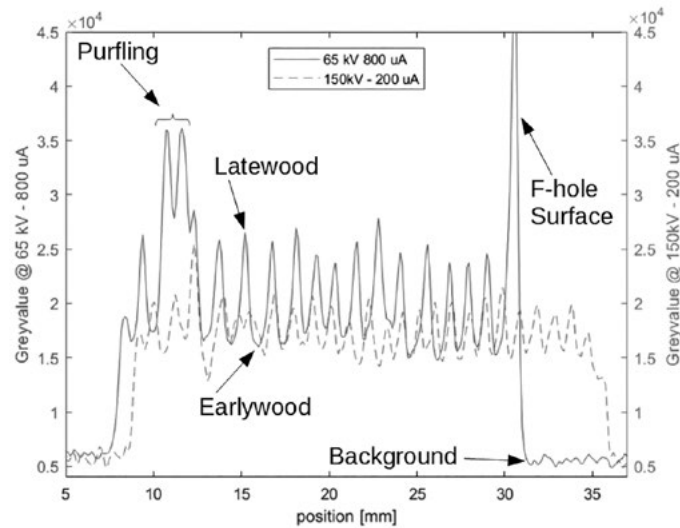

2.4. Detector Binning

The analysis of violin features has close similarities to defect detection and characterization in industrial manufacturing. As in cast or forged metal parts, the shapes and dimensions of “defects” are important characteristics. A crucial role is played by the voxel size: to be properly detected and measured, a feature should be at least 2-3 times larger than the voxel size. For a given multi-resolution CT system and a given violin, a smaller voxel size means also longer acquisition time and larger dataset to deal with. For the CT system used in this work, the dataset dimension for a whole violin scanned at 110 mm is around 24 GB.

Fig.4 65 kV, 800 μ A, voxel size 112 μ m.
Fig.5 150 kV, 200 μ A, voxel size 108 μ m.
Fig.6 Grey value profile for coronal slices of **Fig.4** (solid line) and **Fig.5** (dotted line).

In comparison, Sodini indicates a dataset dimension of 300 Gb for a violin scanned at 80 mm with a similar detector dynamic (16 bit) [9].

Further flexibility can be gained using the “binning” mode. With this approach, the pixels making up the X-ray detector area are grouped into 2x2 (or 4x4) pixel groups. Each of them acquires data as a single pixel, as shown in **Fig.7**. The acquisition time is considerably faster, at the cost of a voxel size increased by a factor of 2 (or 4).

Fig.7

Binning Options	Combined pixels on the CCD Chip
None	
2 x 2 (4 pixels = 1)	
3 x 3 (9 pixels = 1)	
4 x 4 (16 pixels = 1)	

A region of a violin body (measuring approx. 100x204x170 mm) was scanned using these different modes and then with different resolutions. The data are summarized in **Table 1**.

Table 1

mode	Voxel size [μ m]	Dataset dimension [GB]	Scan time [min]
4x	447	0.08	3
2x	224	0.77	6
1x	112	5.80	24

A coronal section of the violin is represented in **[Fig.8]**. At 447 μ m voxel size, wood macro-anatomical features such as small growth rings are not clearly identified, but the biggest defects are visible. This resolution is useful for fast identification of defects starting from 0.8 mm and with a strong radiographic contrast, such as holes or very dense filler materials. In the intermediate resolution, macro-anatomical features such as growth rings are visible, and residual from woodworm attack can be isolated from the wood itself. The filler material morphology (areas with brighter grey values) turns out to be porous. Finally, the smallest voxel size gives the best representation of both the wood structure and the defects.

Fig.7 Detector binning examples.
Table 1 Effect of voxel size on dataset dimension and scan time.

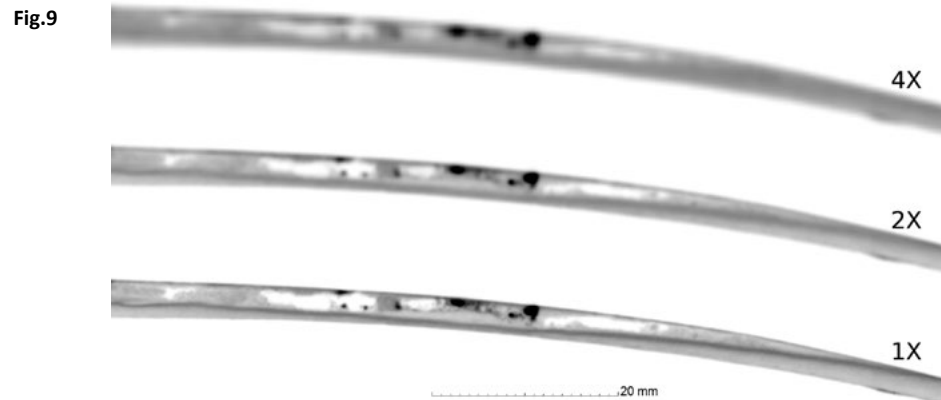
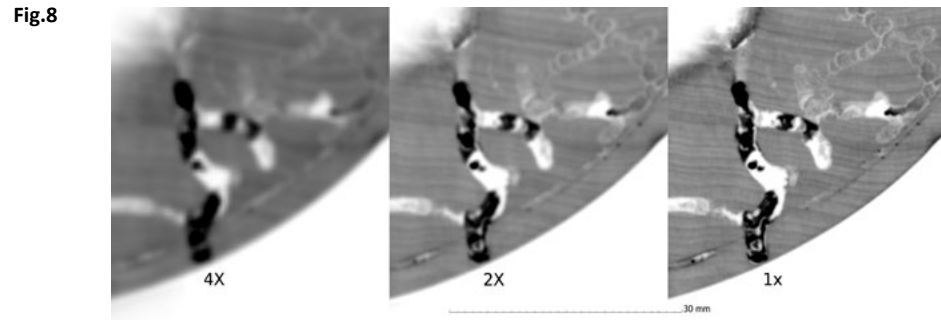

The same comparison is performed in **Fig.9** in an axial section of the violin back, showing the effect of voxel size in the representation of wood and defect features.

2.5. Other Parameters

The number of projection N_p is the number of images used in a CT scan. A lower number of projections increases the artefacts and decreases the image quality. The ISO 15708_3 suggests an estimate of the minimum number of projections as:

$$N_p > \frac{\pi}{2} \cdot N_V \quad (6)$$

Fig.8 Coronal section of a violin back at three different voxel sizes: 447, 224 and 112 μm (4x-1x mode), from left to right.

Fig.9 Axial section of a violin back at three different voxel sizes: 447, 224 and 112 μm (4x-1x mode), from top to bottom

Where N_V is the number of voxels across the sample largest dimension. This formula does not apply in the case of detector shift and/or in helical scans. After the scan, concerning the reconstruction part of the process, NSI efX proprietary software was used. With this software, it is possible to use filters and to set certain corrections, such as a beam hardening correction that reduces the beam hardening effect. Lastly, the reconstructed volume was imported into Volume Graphics with a 16bit unsigned map, which is consistent with the acquired 16bit quality images (related to the detector used).

2.6. Multi-Material Surface Determination

Surface determination is a fundamental step in quantitative CT analyses. Every measurement performed on a CT volume requires a surface, defined as the separation between the part of interest and the surrounding material (e.g., air). Work-pieces can be composed by one or many components and/or made with materials with heterogeneous densities. Ebony fingerboard, filler materials or neck nails are examples of components with densities that are very different from the rest of the bowed stringed instrument. Surfaces are therefore defined as the boundary between different components (such as top, back, bass-bar, neck graft and fingerboard) that can be made of the same or different materials. Even the same material can show great variation in density, such as early- and late-wood in the example of spruce, resulting in a locally heterogeneous material.

The simplest surface determination uses global thresholding algorithms [10]: for instance, a single grey value ISO50 can be assigned to the surface, calculated as the average of the background and material peak in the grey-value histogram (see **Fig.10**). Bowed stringed instruments are rarely made of homogeneous material, at least due to the inherent variation in wood density. In their grey-value histograms, the region belonging to material exhibits at least a couple of peaks. This is evident in **Fig.10**, showing the frequency distribution of grey values for a region of interest in the violin, used in the examples shown above. If the low density peak is used, ISO50 will be closer to the background peak (see ISO50₁ in **Fig.10**). If the peak on the right is considered, ISO50 will be superposed to the lower part of the material histogram (see ISO50₂ in **Fig.10**). Rather than using a single ISO50 grey value, the so-called “local adaptive thresholding” [10] starts from an initially determined ISO50 surface and adapts it locally, defining the surface in correspondence with the grey value maximum gradient. Like other commercial software, VGStudio MAX 3.1 (Volume Graphics GmbH, Germany) uses its own proprietary algorithm for the so-called advanced surface determination. All the measurements and volume registrations presented in section 3 are based on this type of surface determination.

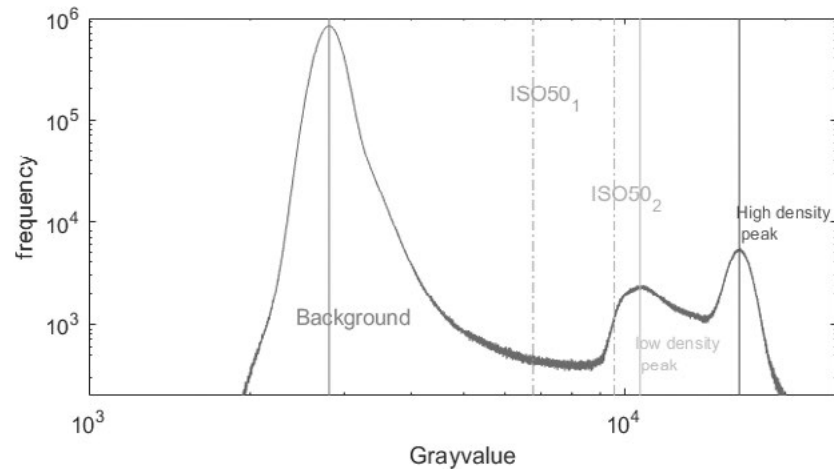
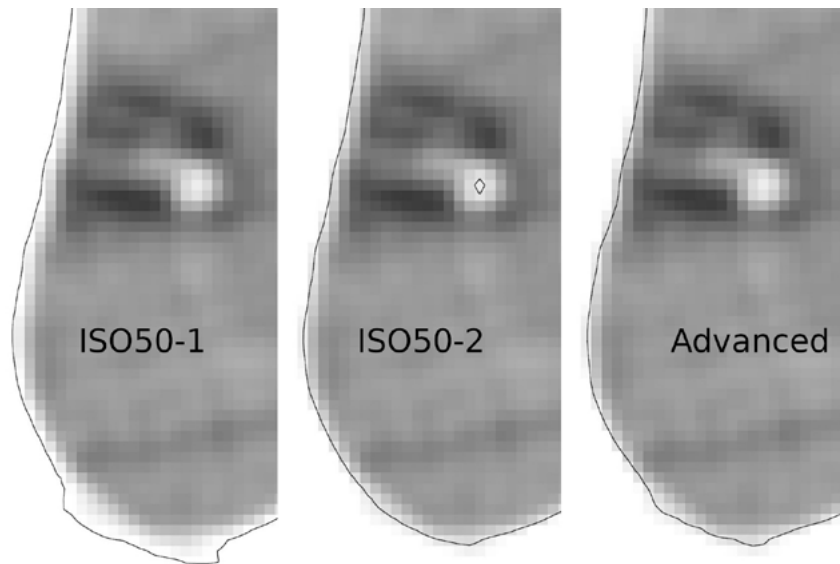
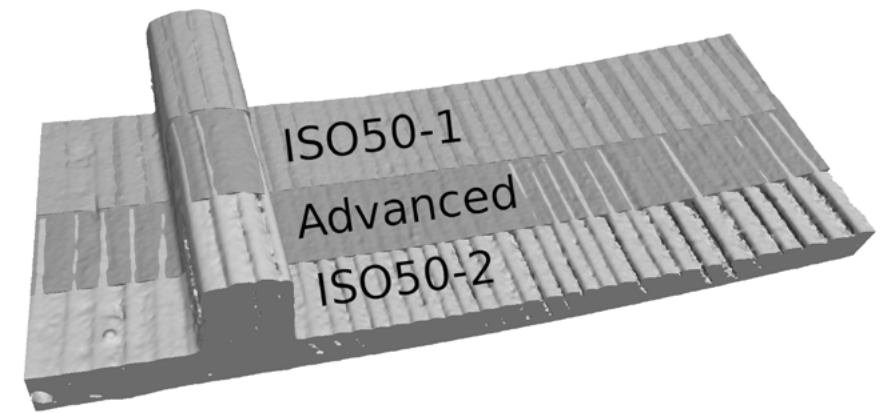
Fig.10**Fig.11****Fig.10** Grey-value histogram of a portion of the violin analysed in this section, showing various peaks: background, low-density and high-density peak.**Fig.11** Comparison among surface boundary created with global (ISO50-1 and ISO 50-2) and local (advanced) thresholding.**Fig.12**

Global thresholding and advanced determination are used to define the surface of the same violin represented in **Fig.8** and **Fig.9**. A detail of an axial slice of the back edge is shown in **Fig.11**. The corresponding ISO50 values are plotted as dash-point lines in the histogram in **Fig.10**. If the high-density peak is considered the reference for the material (ISO50₂), lower density regions (such as early-growth wood in spruce) will be underestimated in dimension, with the creation of voids and recesses (see middle slice, showing a hole below the purfling). When using ISO50₁ (low-density peak, slice on the left), surfaces of high-density regions are overestimated. VGStudioMax 3.1 advanced surface determination algorithms create surfaces in the highest grey value gradient regions, and can also avoid the creation of unwanted voids and noise particles.

Fig.12 shows a 3D representation of the same ISO50 and advanced surfaces. The effect of thresholding can be extremely relevant for heterogeneous materials such as spruce.

Determined surfaces can be exported as STL or point cloud files for reverse engineering or other applications.

3. CT Metrology

X-ray CT has proved to be a useful diagnostic tool in musical instrument making and restoration. It has also been used to document the condition of bowed stringed instruments. Non-contact systems like laser scanners and structured light scanners (LS) have positive advantages in terms of portability, device cost and fast acquisition time. However, they cannot be used with very dark and reflective surfaces,

Fig.12 Effects of the different global and local thresholding on the surface of a portion of violin top.

both common characteristics of violin surfaces. Therefore, this type of surface should be covered with optically cooperative coatings, which is not always desirable for musical instruments.

Medical CT systems were already used for the reverse engineering of violins, as reported in “The Betts Project” [11]. This kind of application of medical CT is normally limited by its resolution. Industrial CT may overcome the limitations of medical CT thanks to higher resolution and better radiographic contrast.

The following sections focus on the application of industrial CT in the reverse engineering and measurement of bowed stringed instruments, and synthesize findings already presented in [12]. The aim of this work is to evaluate CT as a tool for the dimensional analysis of a violin soundboard. This part of the violin has been chosen because it presents a wide range of common problems related to the dimensional analysis of wooden free-form instruments such as violins or other strings.

3.1. Materials and Methods

We focused on comparing the performance of CT and LS when measuring a violin soundboard. In order to assess the accuracy of CT measurement results, a tactile coordinate measuring machine (CMM) was used as the reference. Tactile CMMs are well established in industrial coordinate metrology, due to their proven accuracy and to the availability of internationally accepted standards for performance verification and measurement uncertainty determination (ISO 10360 [13] and ISO 15530 [14]). However, when measuring free-form handmade objects like violins, because of the extreme variability of surface curvature and the presence of non-accessible features, tactile CMMs show several limitations, including the risk of damaging the instruments.

A test sample was designed (Fig.13, right) and machined from red spruce (Fiemme Valley, Italy) with a CNC milling machine. The test sample was conceived to include the typical features measured on a violin top plate, and to be tested by the three systems used in this research: CMM, LS and CT.

A set of measurands were defined, each representing a feature of the real violin soundboard, such as the overall dimensions, f-holes positions, plate thickness and elevation maps. In compliance with the similarity requirements stated in [14], the sample can be used to assess the measurement uncertainty for real violin top plates.

CT and structured light analysis of the test object were performed in the same conditions and with the same measuring procedure adopted for the analysis of the original violin component. The sample was measured with a ZEISS Prismo tactile CMM and scanned with the NSI X5000 CT system introduced earlier in this chapter. Finally, a set of surfaces was acquired by means of a structured light scanner

Fig.13

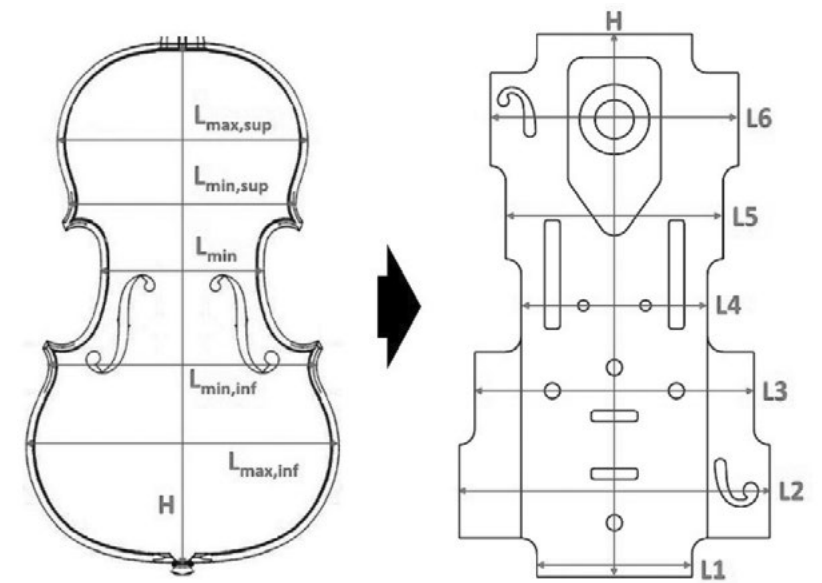

Fig.14

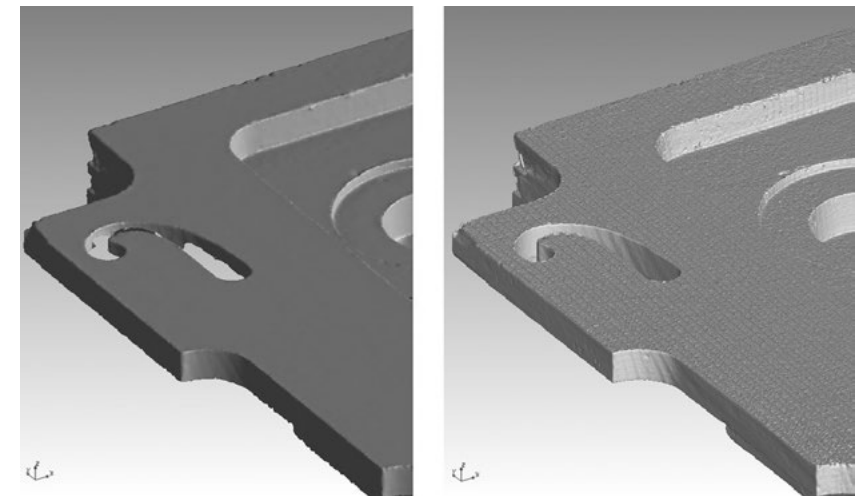

Fig.13 Test sample (right) vs a violin top plate (left), with superposed measurands.
 Fig.14 Comparison between LS polygon surface (left) and CT determined surface (right) of the “soundboard” test sample.

Open Technologies Cronos 3D. For each measuring technique, three repeated scans were performed. All the results (corresponding to the measurands) acquired with the different techniques were put in comparison, together with their relative variability.

Deviations of CT and LS from the reference (CMM) were evaluated. Furthermore, the corresponding measurands of the inside surface of a Nicola Amati (Cremona, 1652) violin belly were measured using CT and LS. The outside surface of the violin top is too dark and shiny to be scanned with the chosen structured light scanner.

3.2. Results

Table 2

Measurand	Average value [mm]			σ [mm]		Δ [mm]	
	CMM	CT	LS	CT	LS	CT-CMM	CT-LS
L1	99.974	99.819	100.144	14	129	26	350
L3	179.654	179.561	180.12	16	75	-92	466
L4	119.782	199.749	120.123	11	77	-33	341
L5	139.755	139.732	140.127	11	47	-23	372
L6	159.54	159.642	160.102	10	33	102	562

Table 3

Measurands	Value [mm]	U_{CT} [μm]
D _{inf}	9.574	28
D _{inf}	9.824	28
D _{sup}	5.976	33
D _{sup}	5.837	33
E	69.286	70
E	67.564	69
L	4.445	22
L	4.655	22

The results obtained for measurands L1, L3-L6 (see **Fig.13**) are reported in **Table 2**. Temperature and relative humidity were monitored throughout all measuring sessions. Comparing the results obtained with CMM, CT and LS provides several indications. The values from CT have an absolute deviation $|\Delta|$ from CMM values ranging from 92 to 102 μm . LS constantly overestimates the measured dimensions, with a positive Δ deviation ranging from 350 to 560 μm .

Moreover, CT results have a significantly lower standard deviation with respect to LS: CT standard deviations range from 10 to 16 μm , while the LS ones are from 33 to 129 μm . This confirms the good

Table 2 Comparison of results for the soundboard sample L1-L6 measurands.

Table 3 Examples of uncertainty evaluation for f-hole measurands on a Nicola Amati violin.

repeatability of CT measurements and the stability of the environmental conditions during the scanning process.

Uncertainties according to ISO 15530-3 [14] have been calculated for all measured dimensions. After the uncertainty evaluation, a similar set of measurands were evaluated in a real violin belly (a Nicola Amati, Cremona, 1652); the results are reported in **Table 3**. In the last column, the uncertainties were calculated using an adapted approach of ISO 15530-3 as suggested in [15, 16], based on repeated CT measurements of the “soundboard” test sample, which was used in substitution of the real violin belly according to the substitution method [16], with reference measurements performed by CMM.

The experimental findings demonstrate that CT provides better results, in terms of measurement repeatability and uncertainty, compared to LS. A major advantage provided by CT is the possibility of extracting information on the inner geometries of bowed stringed instruments, and being able to process dark and shiny surfaces. These types of measurement tasks, indeed, are not possible with traditional optical scanners without opening the instrument or altering its optical surface behaviour.

4. Conclusions

The application of industrial X-ray computed tomography to bowed stringed instruments has opened up new possibilities in material analysis, defect diagnostics and metrology of these musical instruments. In recent years, industrial CT systems have shown continuous improvements in terms of resolution, acquisition speed, image quality and dimensional accuracy.

Experimental investigations have shown that detector binning allows the creation of CT volumes of a complete violin at 0.4 mm voxel resolution in a matter of minutes, making it competitive with medical CT in terms of cost, but still providing better radiographic contrast and overall image quality. With higher voxel resolutions, experimental results showed that the quality of CT reconstructions is significantly enhanced, but at the cost of longer scan time.

When compared to medical scanners, industrial CT systems have great flexibility in terms of tube and detector parameters, as well as in geometrical magnification. The effect of these parameters on the final results has to be taken into account when setting them for a specific application.

Dimensional metrology of 3D surfaces is a promising application of industrial CT to bowed stringed instrument, where it has proved its ability to reduce uncertainty with respect to an optical 3D acquisition method such as structured light scanning.

ACKNOWLEDGEMENTS: The authors would like to thank Manuel Rigodanza for his contribution to the CT metrology application during his master thesis in Product Innovation Engineering at University of Padova, Dr. Valentina Aloisi (University of Padova) for her significant support in CT metrology, Fabrizio Rosi and Luca Passani (TEC-EUROLAB) for the CT and CMM activities, Walter Barbiero for structured light scanning, and Franco Simeoni for providing the Nicola Amati violin.

References

- [1] M. J. Arnoldi, Ed., *Engaging Smithsonian Objects through Science, History, and the Arts*. Washington, D. C.: Smithsonian Institution Scholarly Press, 2016.
- [2] T. Borman and B. Stoel, "Review of the uses of computed tomography for analyzing instruments of the violin family with a focus on the future," *J. Violin Soc. Am: VSA Papers*, vol. 22, no. 1, pp. 1-12, 2009.
- [3] N. Plat and S. Kirsch, "Post-processing of musical instrument 3D-computed tomography data for conservational applications," *Proc. WoodMusICK FP 1302 Cost Action Conf.*, Brussels, 2017.
- [4] J. Garcia-Cobian and G. Bissinger, "Creating an accurate solid model of the violin from CT scans," *Proc. of the IMAC-XIX: A Conference on Structural Dynamics*, Feb. 5-8, 2001, 4359, pp. 373-378. Bethel, CT: SPIE-Int. Soc. for Optical Engineering, 2001.
- [5] F. Piasentini and M. Moscatti, "Assessing musical instruments conditions before and after restoration using industrial X-ray CT," *Proc. WoodMusICK FP 1302 Cost Action Conf.*, Brussels, 2017.
- [6] G. Verberkmoes, "Study on the life, instruments and construction methods of the eighteenth century violin maker Benoit Joseph Boussu – A presentation of the project," *Proc. WoodMusICK FP 1302 Cost Action Conf.*, Barcelona, 2016.
- [7] P. Ribo *et al.*, "Wood-wind craftwork and numerical world: An experience," *Proc. WoodMusICK FP 1302 Cost Action Conf.*, Barcelona, 2016.
- [8] N. Sodini *et al.*, "Non-invasive microstructural analysis of bowed stringed instruments with synchrotron radiation X-ray microtomography," *Journal of Cultural Heritage*, vol. 13, 2012.
- [9] N. Sodini *et al.*, "Comparison of different experimental approaches in the tomographic analysis of ancient violins," *Journal of Cultural Heritage*, vol. 27, 2017.
- [10] S. Carmignato, W. Dewulf and R. Leach, *Industrial X-Ray Computed Tomography*. New York, NY: Springer, 2018.
- [11] S. Sirr, J. Waddle and S. Rossow, "Recreation of a violin crafted by Antonio Stradivarius in Cremona," *Radiological Society of North America, Scientific Assembly and Annual Meeting*, Chicago, 2011.
- [12] F. Piasentini *et al.*, "Evaluating the use of Industrial X-Ray CT for the reverse engineering of bowed stringed instruments," *Proc. WoodMusICK FP 1302 Cost Action Conf.*, Barcelona, 2016.
- [13] ISO 10360-2: 2009. *Geometrical product specifications (GPS) – Acceptance and reverification tests for coordinate measuring machines (CMM) – Part 2: CMMs used for measuring linear dimensions*. Geneva: ISO, 2009.
- [14] *Part 3: Use of calibrated work pieces or measurement standards* in [13].
- [15] P. Müller, J. Hiller, Y. Dai, J. L. Andreasen, H. N. Hansen and L. De Chiffre, "Estimation of measurement uncertainties in X-ray computed tomography metrology using the substitution method," *CIRP Journal of Manufacturing Science and Technology*, vol. 7, pp. 222-232, 2014.
- [16] P. Hermanek and S. Carmignato, "Porosity measurements by X-ray computed tomography: Accuracy evaluation using a calibrated object," *Precision Engineering*, vol. 49, pp. 377-387, 2017. doi: 10.1016/j.precision.eng.2017.03.007.

Geometrical Analysis on the Design of Stringed Instruments

*A Useful Method for Luthiers
and Musicologists?*

SIMONE REGINA ZOPF, FLORIAN HERTZSCH, MANUEL HROVATH,
JAKOB NACHBARGAUER, ANDREAS SEYER-KLICZNIK
Department of Lutherie, HTBLA Hallstatt, Austria

Abstract

The design of musical instruments in the sixteenth to nineteenth century, was, like many other art forms, strongly influenced by the ideas of Pythagoras and other numerical rules for proportions. The discovery of such patterns, using geometrical analysis, can be very helpful and provides a great deal of information about the luthier's origin and education, and about the construction of the instrument itself. It can help to reconstruct missing parts of the instrument and to understand the way it was built. Based on the knowledge of historical drawing and measuring tools, techniques and methods have been developed to reveal the principles of the design of stringed instruments.

1. Introduction

Musical instruments are unique artefacts combining art and technology in a very specific way. Until the end of the nineteenth century, they were designed using a compass and a ruler, applying certain proportions and revealing the close relationship between mathematics and music. This aspect of instrument making was the chief topic in numerous publications [1, 2, 3] and opened up a different view to the study of instruments.

This study was based on the outline formations of stringed instruments (mostly violins), consequently providing specific information about the measuring unit and thus, the key to unravelling the geometric construction. Another aim was to find an easy and convenient way to reconstruct the shape of the instrument, the sound holes and string length. Geometric analysis is a reverse method, based on the dissection of the curves into single radii and finding a plausible way to explain the construction.

The bases for geometrical analysis were obtained by studying and mapping the outlines of instruments and drawing real objects. Violins by Antonio Stradivari, instruments by Gasparo da Salo, a viola da gamba by Henry Jaye and Francesco Linarol, guitars by Johann Georg Stauffer and Stoss and some lutes were analysed. High quality photographs of instruments and reliable measurements were also used.

More than 86 drawings, pictures and objects were investigated with the measuring unit that was possibly used. Rulers and concentric patterns based on this unit were built, and a compass copied from a historical model was produced. Subsequently, the possible construction of the instrument was transferred to AutoCAD or another drawing program. When the analysis was finished, the whole process of the construction was verified by more than ten students and drawn by hand, using the historical tools to prove the practicability and reliability of the geometrical analysis, and adaptations were made if necessary. Finally, step by step instructions were formulated.

The aims of this study were the following:

- To find the possible standard length unit of each investigated instrument
- To understand the construction of the outline
- To analyse the construction of f-holes on Cremonese violins
- To obtain information about the geographical distribution of measuring units
- To gain knowledge to substitute missing parts
- To compare designs of different makers to find interferences of similar construction methods and re-enact possible transfers of knowledge
- To attribute instruments to a certain region or school
- To establish a procedure for a geometrical analysis.

Possible use of the Roman oncia for the construction of Cremonese and Brescian instruments and the existence of the particular constructional system, using concentric circles for the Cremonese violins, was shown. Use of the Augsburg inch (available in Füssen) was identified in many instruments by Austrian and German luthiers, confirming theories of origin and relations between them or the transfer of knowledge. Through analysis of an English viol and associated research, information on the length of the original neck was able to be obtained. A method of analysing the design of instruments was developed, and the possibilities and limits of this method are discussed herein. Several constructional patterns were identified and will be published to expand current knowledge of instrument design.

2. Material and Method

2.1. Material

The shapes of various musical instruments from the sixteenth to nineteenth centuries from all over Europe were analysed, chosen for their historical importance, availability of data and the quality of the outlines. Data were obtained from measurements of instruments, technical drawings and/or high-quality pictures combined with measurements. One difficulty in gathering the data was unclear descriptions of the measurements: bowed instruments with arched tops are often measured over the arch and not with a calliper. Another challenge encountered was data differing from the technical drawing and description. Unfortunately, the size of the top and bottom plate is not always congruent but can be explained by the instrument-making process or the slightly different ratio of wood shrinkage. These uncertainties have to be estimated in order to make an analysis. The sources for the measuring unit values (Roman oncia, Augsburg, Venetian, Tyrolean, Saxonian and English inch) were studied by Herbert Heyde and Grant O'Brien. [4, 5].

2.2. Method

- The outlines were calibrated to their true size or taken from a real object and investigated by using historical drawing tools. Therefore, especially large compasses and rulers in the most common European measuring units were produced.
- Based on the information already known about the instruments, certain measuring units were chosen. In most cases, the numbers of the maximum width or length of the corpus reveal the unit. Tolerances of 1% of the width were taken into account. In the case of a violin for instance, having a maximum width of 202 mm, the estimated shrinkage factor was 2 mm.

- Once the standard measuring unit was established, whole- and half-number circles were drawn on transparent paper and compared with the outline. If the standard measuring unit was not clearly detectable (the values of some units are very close to each other), the instrument was analysed with several units. Deviations of 0.5 mm were accepted, after which the construction was developed.
- The information was then transferred to a drawing program like AutoCAD, and the drawing process was digitally repeated. If several radii were obtainable, the results with less complicated construction were chosen. If possible, sound holes and string lengths were included for the geometrical analysis.
- Following this, more than ten students of the luthier school in Hallstatt repeated the entire construction, using the historical drawing tools as discussed.

Step by step instructions were developed and the acquired data were collected [Table 1].

Fig.1

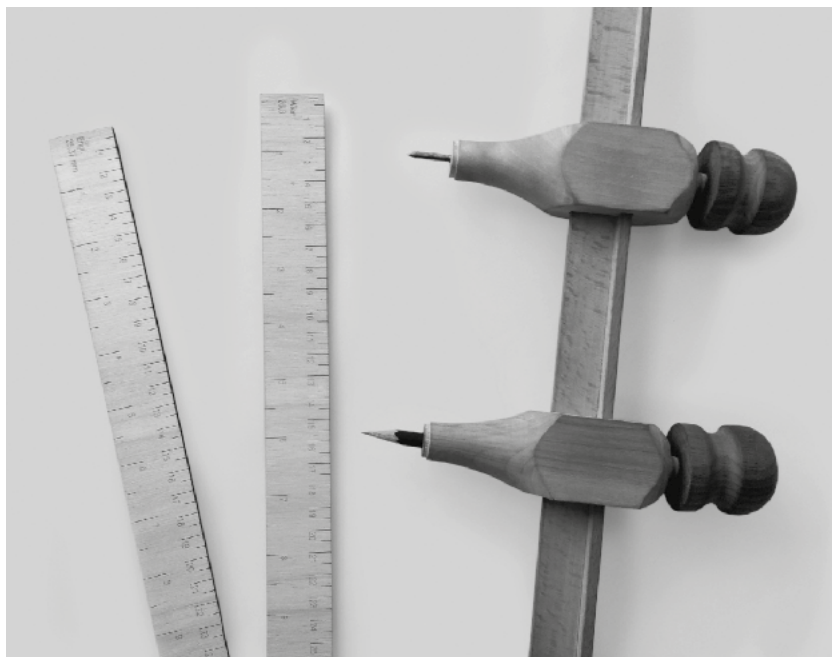

Fig.1 Wooden compass reconstructed after a historical model and rulers with various standard measuring units.

Fig.2

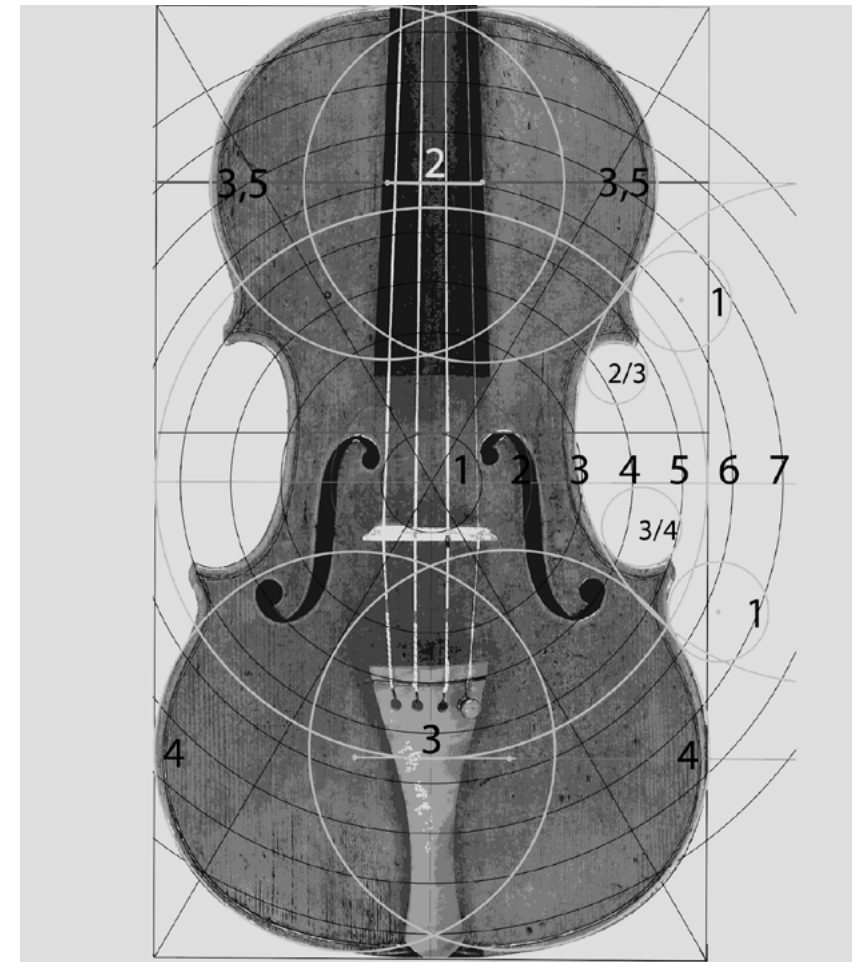

Fig.2 Geometrical analysis of A. Stradivaris, "Gibson" 1713; all values in Roman oncia (=18.6 mm).

Table 1

Instrument	Type of instrument	Luthier	Region
A. Amati 1566,	Small Violin	A. Amati	Cremona
A. Stradivari, "Sarasate"	4/4-Violin	A. Stradivari	Cremona
A. Stradivari, "Davidoff"	4/4-Violin	A. Stradivari	Cremona
A. Stradivari, "Provigny"	4/4-Violin	A. Stradivari	Cremona
A. Stradivari, "Queux"	4/4-Violin	A. Stradivari	Cremona
A. Stradivari, "Tua"	4/4-Violin	A. Stradivari	Cremona
A. Stradivari, Viol	Viola da gamba	A. Stradivari	Cremona
A. Stradivari, "Harrison"	4/4-Violin	A. Stradivari	Cremona
A. Stradivari, "Messiah"	4/4-Violin	A. Stradivari	Cremona
Brothers Amati	4/4-Violin	Gebr. Amati	Cremona
Brothers Amati ~1600	Violoncello	Gebr. Amati	Cremona
Girolamo Amati	Viola	Gebr. Amati	Cremona
N. Amati 1667	4/4-Violin	N. Amati	Cremona
N. Amati 1639	4/4-Violin	N. Amati	Cremona
H. Amati II	Double Bass	H. Amati II	Cremona
Rugeri (?)	4/4-Violin	Rugeri (?)	Cremona
Guaneri Del Gesu	4/4-Violin	Del Gesu	Cremona
C.F. Landolfi	4/4-Violin	C.F. Landolfi	Cremona/Milano
J. Stainer 1668	4/4-Violin	J. Stainer	Tyrol
J. Stainer	Viola da gamba	J. Stainer	Tyrol
J. Stainer ex Hämmerle	4/4-Violin	J. Stainer	Tyrol
Anonymos Urbino 1550	Citter	Anonymus	Urbino
P. di Zanetto 1564	Viola	P. di Zanetto	Brescia
G. da Salo <1609	Viola	G. da Salo	Brescia
Gaspar da Salo	Double Bass	Gaspar da Salo	Brescia
Maggini	4/4-Violin	Maggini	Brescia
G. Virchi , E. 1271	Cister	G. Virchi	Brescia
G. Virchi , MR.R434	Cister	G. Virchi	Brescia
G. da Salo	Lyra da Gamba	G. da Salo	Brescia
G. da Salo	Double Bass	Gaspar da Salo	Brescia
H. Frei	Luth	H. Frei	Füssen
Burckholtzer 1596	Luth	Burckholtzer	Füssen
Anonymus 1686	Double Bass	Anonymus	Austria
Anonymus, ca. 1850	Small Guitar	Anonymus	Austria
Rauchwolf,1596	Luth	Rauchwolf	Augsburg
A. Posch	Violoncello	A. Posch	Vienna
M. Thir	4/4-Violin	M. Thir	Vienna
M. Stoss<1813	Romantic Guitar	M. Stoss	Vienna
L. Reisinger ca.1930	Harp guitar	L. Reisinger	Vienna
"Stille Nacht-Gitarre"	Romantic Guitar	Anonymus	unknown
Anonym Guitar<1901	Small Guitar	Anonymus	unknown
J.Tielke	Baroque Guitar	J. Tielke	Hamburg
Bochem,small lute	small luth	Dierich Bochem	Köln
B. Benks 1750-1796	Violoncello	B. Banks	England
H. Jay <1700	Viola da gamba	H. Jay	England
F. Linarol 1581	Viola da gamba	F. Linarol	Venice
Anonymus 1594/95	Basslautencister	Anonymus	unknown
Anonymus	Baroque Guitar	Anonymus	unknown
J.B. Voboam	Baroque Guitar	J.B. Voboam	Paris
Rodrigo Gonzalez 1869	Guitar	R. Gonzalez	Spain

Max. width		Unit	Source
10.5"	K	Roman oncia	Plan [12]
11 1/4"	K	Roman oncia	Object
11"	K	Roman oncia	Object
11"	K	Roman oncia	Object
10 3/4"	K	Roman oncia	Object
11"	K	Roman oncia	Object
22.5"	K	Roman oncia	Plan [13]
10.84"	K	Roman oncia	Plan [13]
11 1/4"	K	Roman oncia	Plan [12]
11 1/4"	K	Roman oncia	Plan [13]
23.5"	K	Roman oncia	Plan [12]
13"	K	Roman oncia	Picture [14]
10.9"	K	Roman oncia	Object
10 3/4"	K	Roman oncia	Object
38"	K	Roman oncia	Plan [12]
10 3/4 "	K	Roman oncia	Object
11"	K	Roman oncia	Plan [12]
?	?	- not found	Object
7 1/4"	R	Tyrolean inch	Picture [15]
15"	R	Tyrolean inch	Plan [16]
7 1/4"	R	Tyrolean inch	Picture [12]
16.5"	R	Roman oncia	Picture [10]
13.4"	R	Roman oncia	Picture [17]
13.4"	R	Roman oncia	Picture [17]
41 3/4"	R	Roman oncia	Plan [12]
11"	R	Roman oncia	Picture [17]
11"	R	Roman oncia	Object
12"	R	Roman oncia	Object
17 3/4"	R	Roman oncia	Object
41.7"	R	Roman oncia	Plan [12]
11.9"	K	Augsburg inch	Plan [12]
13.4"	K	Augsburg inch	Plan [12]
25.5"	R	Augsburg inch	Object
0	K	Augsburg inch	Object
12"	R	Augsburg inch	Plan [18]
18"	R	Augsburg inch	Object
8"	R	Augsburg inch	Object
12 3/4"	R	Augsburg inch	Object
424 mm	R	metric	Object
12"	R	Saxonian inch	Object
12 1/4"	R	Saxonian inch	Object
9.9	R	Altköln inch	Plan [18]
11"	K	Altköln inch	Object
?	?	- not found -	Object
15.5"	R	English inch	Object
15"	R	Venecian inch	Object
30"	R	Roman oncia	Object
8.9"	R	Parisian inch	Plan [8]
9 1/4"	R	Parisian inch	Picture [19]
349 mm	R	metric	Plan [20]

Table 1 Investigated instruments, K = concentric pattern, R = rectangular pattern. Deviances of one tenth of the measuring unit were calculated.

In certain cases, it was necessary to analyse several instruments from the same maker. If the same size of instrument was not available, other instruments such as violas or violoncellos were introduced for investigations. In addition, other luthiers from the same region or time period were taken into account. Additionally, other sources such as architecture and paintings were researched for geometrical principles or drawing devices.

3. Results

3.1. To Find the Possible Standard Length Unit of Each Investigated Instrument

Only a few constructions of outlines are singularly based on abstract proportions, and most of them cannot be understood without knowing the standard measuring unit. Therefore, determining the unit is of vital importance. In most cases, the unit was able to be found by looking for whole- and half-number values in the maximum width and length of the corpus and using the local unit. The maximum width of the viola da gamba by Linarol, for instance, is 432 mm, which equals 14.94 Venetian inches. Due to wood shrinkage, 15 Venetian inches seems to be a highly likely original dimension. In the case of Cremonese violins, the unit could not be found until a very special, concentric system, using the Roman oncia was applied.

In 84 of 86 cases, a standard measuring unit was identified, but in the case of Jacob Stainer, finding this unit was particularly challenging: several instruments of various sizes had to be investigated to find the standard length unit. This fluctuation was caused by the close mathematical relation of the Roman oncia (18.6 mm) and the Tirolean inch (27.85 mm) by a factor of 2:3. However, analysis of larger instruments, such as Stainer's tenor viola and viola da gamba, indicated more likely use of the Tirolean inch.

Based on a former study on the standard length unit of Cremonese violins [6], the maximum width of an instrument may be the strongest indicator for establishing the measuring unit. In the case of Cremonese violins, however, the string length or position of the bridge is of key importance. This position was identified by measuring the line between the nicks of the f-hole, and not the actual position of the bridge. From all of the violins under investigation, the exception to the rule (with the bridge position one inch below the centre), was the Guarneri del Gesù violin. In this case, the bridge position varied between half an inch to three quarters of an inch below the centre. In other instruments such as lutes and viola da gambas, this position is not so easy to define.

3.2. To Understand the Construction of the Outline

Based on knowledge of the standard measuring unit, it was possible to carry out a geometrical analysis, leading to a step by step description of the drawing process. The construction of Cremonese violins, which

has been the topic of hundreds of publications since the 1780s, was interestingly the simplest to remember and can be adapted for all sizes of the violin family. Other concepts, such as those used by Stoss, Stainer or Jaye, were quite difficult to understand and revealed the complexity of the human mind. Some analyses also incorporated information about the internal bracing or even the instrument's arching.

3.3. To Understand the Construction of f-Holes on Cremonese Violins

The question of how and where to place the f-holes on violins sparked the entire investigation, based on sketches from the Stradivari workshop showing certain lines and circles and sometimes even the centre of the radii. Since no other technical drawings except the handwriting of Arnould de Zwolle [7] survived, these sketches are a treasure for science and lutherie. Besides the knowledge of the Roman oncia, the construction of the f-holes benefits from certain numbers gained from a geometric sequence, multiplying the value of the Roman oncia, 18.6 mm, by the factor of the fifth, as follows: $18.6 \text{ mm} \times 3/2 = 28 \text{ mm}$ $\times 3/2 = 42 \text{ mm}$ $\times 3/2 = 63 \text{ mm}$. As visible in the sketches from Stradivari, the sound holes are linked to the outline and placed 42 mm down the centre.

Fig.3

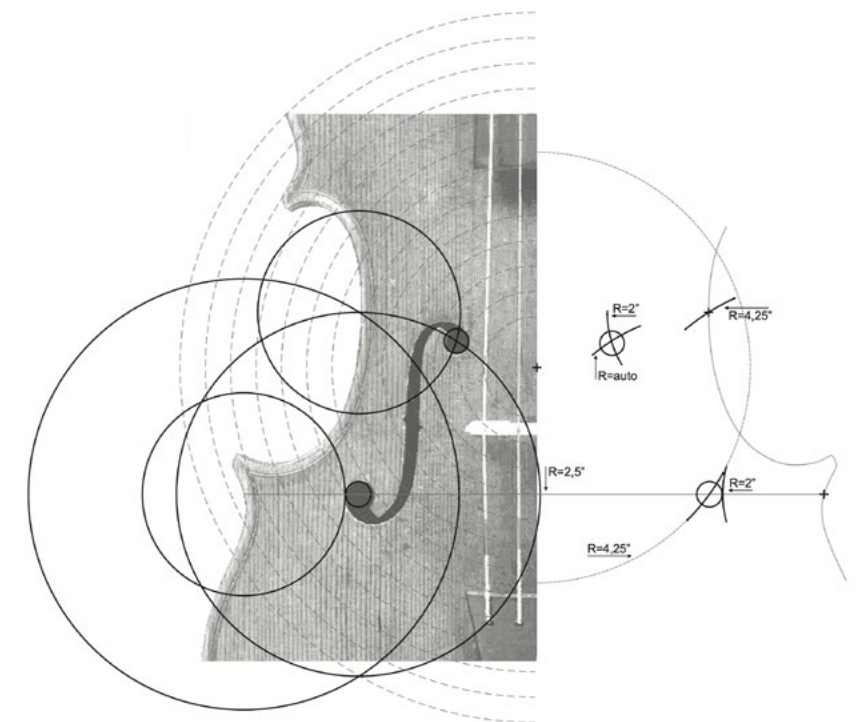

Fig.3

Viol by Girolamo Amati [8], showing the construction of the f-holes according to the sketches of A. Stradivari; all values in Roman oncia.

Construction of f-holes [Fig.3]

The “eye line”, indicating the position of the lower eyes, is located 42 mm down the centre of a violin or 2 ½" down the centre of a viola. Where this line crosses the outline, 1 ½" (violin) or 2" (viola) are measured towards the centre, giving the edge of the lower eyes (viola) or the centre of the eye (violin). A circle with a radius of 63mm or 4 ¼" from the centre is drawn crossing the “eye line”. Where the “eye line” crosses the outline of the instruments, a new point is established. From this centre, a radius of 63 mm or 4 ¼" is made and gives the centre a radius (2") to define the upper f-hole and the centre of the lower eyes. Interestingly, on Cremonese violins the distance between the centres of the eyes of each f-hole is also 63 mm.

3.4. To Obtain Information about the Geographical Distribution of Measuring Units

Usually the standard length unit is said to be the local historical unit of the place the luthier was working in. Nevertheless, in our study, in 72.09% of all cases (62 of 86 instruments) it was not the local unit that was used, but a different unit, probably due to the fact that certain templates were used for several generations, or certain measuring units were transferred through education and not influenced by the luthier’s actual domicile.

Analysing the data of our study, it can be stated that Cremonese and Brescian luthiers used the same measuring unit, the Roman oncia. All nine Brescian instruments investigated clearly show use of this unit. In addition, the templates from the Stradivari workshop show use of the Roman oncia [4]. Furthermore, this particular unit was mentioned in an historical text about bow quality. [9]. As to why this unit was chosen, this is still unknown and requires further investigation.

A similar phenomenon could be found amongst Austrian luthiers: all investigated instruments were constructed using the Augsburg inch, also used by the luthiers in Füssen. It is known that the majority of Viennese Luthiers had ancestors from Füssen or learned their skills from a master descending from Füssen [10]. Also, all investigated lutes except one from Cologne were constructed with this unit. Furthermore, there was a tendency for certain numbers like 7, 21 and 7/2s (Rauchwolf, Burckholzer, Frei) to crop up. Other instruments were able to be analysed with the local historical unit, e.g., F. Linarol (Venice), J. Jaye (England) and J. B. Voboam (Paris).

3.5. To Gain Knowledge to Substitute Missing Parts

One part of this study was dealing with the question of whether or not geometric analysis can help to obtain information to substitute or complete missing parts. Through analysis of a bass viol by Henry Jaye, the position of the bridge was clarified, but the original length of the

Fig.4



neck was missing. On several English viols, a 1:1 proportion between the length of the neck and the body stop is observed [2], which in this case would give a total string length of 30 English inches (=761.1mm), a very long scale for today’s player. Fortunately, we uncovered another source confirming this value: about the string length of a Bass viol, Thomas Mace advised “Let your bass be large” [11]. This information allows for the assumption that this particular instrument by Henry Jaye would have had a scale length of 30 English inches.

Fig.4 Parchment template attributed to Cozio di Salabue, National Museum of Music, distance between rings ca. 18.6 mm.

During our studies of the oncia, a parchment template from the collection of Cozio di Salabue was also found [Fig.4], showing not only concentric rings distanced more or less 18.6 mm away from each other, but also the position of the sound post and bass-bar, each one Roman oncia (18.6 mm) from the centreline. This would indicate a slightly narrower position than today (20mm). X-rays of a violin by Jakob Stainer with a possible original bass bar also show this position (parallel to the centreline). These two facts strengthened the assumption that the original bass-bars of Cremonese violins may have been placed one roman oncia from the centre and probably parallel to the centreline. Unfortunately, very few tops with original bass-bars have survived, so there is not a great deal of evidence to support this hypothesis.

3.6. To Compare Designs of Different Makers to Understand the Transfer of Knowledge

Primarily because of the availability of data, Cremonese instruments were investigated and the analyses were compared. It could be seen that the concentric pattern, probably invented by Andrea Amati, was used in

Fig.5

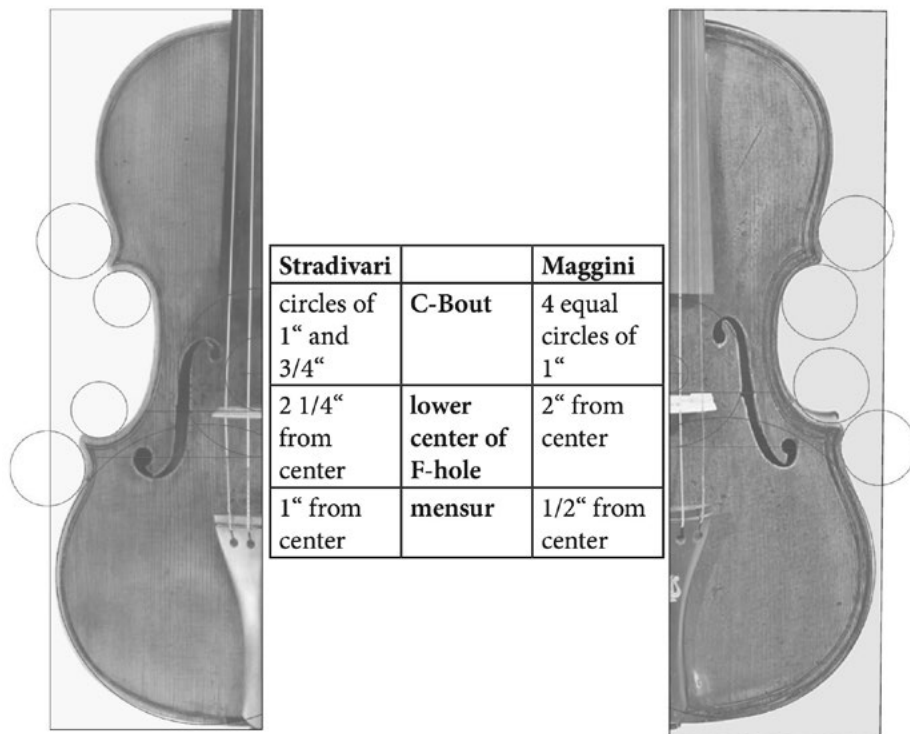

Fig.5 Comparison of Cremonese and Brescian violins: (left) A. Stradivari "Conte de Fontana" and (right) P. Maggini; all values in Roman oncia (18.6mm).

all Cremonese instruments reviewed. Only subtle changes regarding the circles in the c-bout of slightly longer or wider instruments are apparent (e.g., 19.5" instead of 19" and 11.25" instead of 11"). The body stop (1" down the centre) and the position of the f-holes (42 mm down the centre) and the distance of the centre of the eyes of the f-holes, stay the same (Table 2). Guarneri violins mostly differ from this tradition and seem to be influenced by the older, Brescian instruments (total length of the f-hole and position of the body stop). The Brescian instruments, although adopting the same standard length unit, utilized a different approach and are not based on a concentric pattern, but more closely on a grid or rectangular alignment. The most obvious differences are presented in [Fig.5].

3.7. To Attribute Instruments to Certain Makers or a Region

Based on our study, it is not possible to attribute an instrument to an exact maker. Too often, makers have used standard measuring units not directly linked to their environment, and more studies have to be made to explain the transfer of the measuring units.

Some luthiers are using the local measuring unit as Voboam, Linarol, Jaye, Burkholzer, Frei, Rauchwolf and Bochem. In these cases, the evidence of the applied unit supports the origin of the luthier. Use of the Augsburg inch quite far from its origin could show a strong influence of education in a certain group of luthiers, descending from Füssen. The latest, verified use of this unit was discovered in an anonymous guitar, probably Viennese, around 1850. In addition, the application of the Roman oncia in Brescia and Cremona is very interesting and merits further investigation.

In the case of the anonymous guitar—once owned by the composer of "Silent Night", Franz Xaver Gruber—luckily, use of the Saxonian inch was able to be proven and may indicate the origin of this guitar in Markneukirchen or elsewhere in the Vogtland. This unit was also found in a small guitar probably made around 1900, which shows the longevity of patterns or outlines.

3.8. Standard Method for the Geometrical Analysis

For each instrument, part of this study was also to develop step by step instructions for a possible reconstruction and above all, a standard procedure for conducting a geometrical analysis. The following steps were the most efficient way to achieve a satisfying result:

Calibrate the picture or technical drawing to its exact size, in order to minimize misinterpretation and ambiguous values.

The centre of the corpus has to be set and a centre line has to be established.

A rectangle consisting of the maximum width and length of the instrument has to be drawn. Calculate the ratio of length and width as the first clues to the standard measuring unit.

Referring this and other information, try to establish the standard measuring unit. Identify the potential, principal circles and their centres using templates of radii. The next step is to find the construction of these centres. Depending on the type of instrument, sometimes rectangular or concentric patterns are more promising. Clues indicating the likely use of a rectangle are points crossing on diagonals or the existence of a square, based on the maximum width of the instrument. Sometimes the whole rectangle is divided into fifths, ninths, and so on. Also, radii having their centre in the corner of the main rectangle are observed. Indications of concentric patterns are more difficult to find: firstly, the starting point of the construction has to be found. For instance, in the case of guitars, it is in the middle of the corpus or the centre of the sound hole. A promising way to detect such a centre is to try to match all centres of the main radii with one circle.

Once the main radii are established, the search for the connection circles can commence.

When the outline is complete, certain parts of the instrument, such as sound holes and position of the bridge or bracing, should be investigated.

It is advisable to execute the whole reconstruction process with a team of several persons, using a compass and a ruler in the standard length unit to prove the possible application, and in a historical workshop.

4. Discussion

Geometrical analysis can provide numerous data and, together with information from other disciplines, help find answers to technical questions or determine instrument origin. The quality of the data is related to several factors:

4.1. Nature of the Material

Stringed instruments are mainly built of wood. This material is, even after centuries, constantly changing size. This indicates the importance of measuring an instrument in a constant environment, for instance, at 20° Celsius with 40% relative humidity. These values should be documented. Shrinkage due to wood type and grain direction can decrease the width by 2%, meaning a 300 mm-wide guitar could shrink 6 mm. Usually the main radii are not influenced by shrinkage, but their centres are slightly closer in relation to each other. The bigger the instruments, the greater the possibility of deviations from the original design. This is always to be taken into account.

4.2. Quality of Data

Distortion or inaccuracy of pictures and technical drawings are the most difficult obstacles to overcome in order to achieve an accurate analysis. Ideally, the original instrument would still be physically present, to check measurements or estimate which side or plate is closer

to the original template. If the analysis is made digitally, the transfer of data should be minutely checked. Most scanners and cameras have a certain distortion; therefore, it is advisable to have several measurements in length and width to rectify the pictures. Sometimes how the data was obtained has not been documented: arched instruments are quite often measured over the arch, thus, the true value of length and width are not properly represented. Only measurements made with a calliper should be used. Another source of problems is inaccurate technical plans in which drawings and measurement data do not match.

4.3. Centrelines

Centrelines are essential for geometrical analysis, but are rarely exactly in the middle of an instrument, or may have been changed later. Explaining asymmetries requires extensive technical knowledge about the assembly process and the way in which the instrument was built. Usually the plate, which was first glued to the ribs, is closer to the original shape of the instrument. The radii of the upper bout are often more distorted than the lower bout because of later gluing of the neck and correcting the neck angle. In many cases, the instrument's current neck is not the original and is attached in a different way, meaning the centreline has probably shifted as well. Nevertheless, by observing the centrelines of the back and top, it should be possible to determine a certain probability for the positioning.

4.4. Defining the Standard Length Unit

Defining the possible measuring unit is of key interest in decoding designs. This study indicates that the use and dating of measuring units is more complex than originally thought. If the luthier is unknown, the determination process may include the use of several measuring units and a partially realized geometrical analysis. Without this information, a meaningful analysis cannot be carried out. Usually, a complete analysis is highly complex and can only work with one specific measuring unit. According to the date of origin of the instrument, the possible standard unit may vary slightly, but these inaccuracies are mostly explained by wood shrinkage or deviations during the working process. In most cases, the maximum width is the starting point for construction of the instrument, and therefore, can be planned in simple numbers.

During the research, the standard length unit for the instruments made by Stainer was the most difficult to define. Regarding the violin, the main length and widths are very close to those in Cremonese violins and could be read in Roman oncia as well; however, the placement of the f-holes and creation of the body stop does not follow the Cremonese pattern. The principle radii and their position led to the idea of using the Tyrolean inch instead, which was verified by analysing larger instruments such as a tenor viol and a bass viol. This finding may offer

a new angle on the biography of Jakob Stainer, regarding his possible education in Venice or Cremona.

4.5. Accuracy of Measuring Units

Part of this study was to review the deviations in applying the standard measuring units. This depended on the working process and the produced item. Violin scrolls, for instance, due to their complex, three-dimensional shape, have the highest value of deviation, sometimes varying 2 mm from one side to the other. Other values, such as the mean value of the body stop on Cremonese violins, only differ 1 mm from the ideal position (**Table 2**). In general, working style and personal preference had the biggest impact on accuracy. Instruments by Antonio Stradivari or the Brothers Amati were astonishingly perfect and symmetrical, but the instruments by Guarneri del Gesù were quite challenging to analyse. Due to the bending process, guitar outlines differ considerably in terms of symmetry compared to the shape of violins. Instruments like bass viols or violoncellos naturally have increased deviations from the possible construction.

It was very helpful to compare a larger sample of instruments in order to possess more reliable data for the geometrical analysis. Also, comparing geometrical analyses from other luthiers can reveal other approaches to an instrument's construction.

4.6. Types of Instrument Design

Over time, several fundamental forms of design were identified, most of them developing from a rectangle or a concentric pattern. In this study, both variations were applied and in highly combined systems, and both approaches can be found. Usually the rectangle corresponds to maximum length and width, but in lutes and baroque guitars, the length was also defined by other values such as certain frets or crossing arches from the outline. Furthermore, it is important to review the possible construction with several test persons and with historical tools in order to estimate its practicability and reliability.

5. Conclusion

Geometrical analysis can, if carefully done, gather important information for the reconstruction of musical instruments and offer insight into the possible education of the luthier. Altogether, 86 instruments, violins, violas, violoncellos, viols, lutes and guitars made from the sixteenth to the nineteenth century were investigated, and in 84 cases, a complete geometrical analysis was able to be obtained. The most important point is to determine the possible standard length unit. It was noticed that more than 72.09% of the instruments were constructed using a different

standard length unit than the local one. The starting point for construction was primarily the maximum width of the instrument, representing the measuring unit in whole numbers or simple partitions of it.

For a successful analysis, correctly gained data is essential: due to the nature of wood, measurements should be taken under controlled conditions and with certain tools (callipers) to provide reliable data. Pictures are less preferable as the foundation of a geometrical analysis than technical drawings, because of the distortion of camera objectives. For the analysis itself, extensive knowledge of the working process in luthiery is required to be able to estimate reasons for asymmetry or other design distortions. It was found that Cremonese and Brescian luthiers used the same standard measuring unit, the Roman oncia (18.6 mm), and that the Austrian luthiers included in our study, remained with the Augsburg inch (24.65mm) as a result of their training. Cremonese violin-makers, from Andrea Amati to Guarneri del Gesù, preferred a certain concentric pattern and fixed values for the body stop and construction of the f-holes. Thanks to geometrical analysis of a bass viol by Henry Jaye, the most likely length of the neck was obtained, offering a new angle on the possible position of the bass-bar on eighteenth-century violins. Furthermore, in 84 cases, a step by step reconstruction has been obtained, and a standard procedure for carrying out the geometrical analysis has been presented.

ACKNOWLEDGEMENTS: The authors want to thank all students of the department of lutherie in Hallstatt, Austria for supporting this work with so much patience, diligence and passionate interest in this topic. We also want to thank our headmaster, Dir. Jörg Zimmermann for being always supportive of our special research, and Jose Vazquez at the Orpheon Foundation for allowing us to measure and investigate his collection. No funding was provided for this research.

Table 2

instrument	source	length		max. width		r upper bout
		-	mm	-	mm	-
Violins		-	mm	-	mm	-
Nicolo Amati 1628	11	19,0	353	11,0	205	
Nicolo Amati 1635	12	18,9	352	11,0	203,7	3,5
Nicolo Amati 1640	12	19,0	354	11,2	208,2	3,5
Nicolo Amati 1665	12	19,1	355	11,0	205,1	3,5 and 4
Nicolo Amati 1680	12	18,9	352	10,8	201,8	3,5
Nicolo Amati 1683	12	19,0	354	11,3	210,8	
Nicolo Amati Alard	13	18,8	350	11,1	205,8	3,5
Nicolo Amati 1628	14	19,0	353	11,0	205	3,5
Nicolo Amati 1670	14	18,8	350	10,7	199	3,5
Nicolo Amati 1670	14	18,8	350	10,7	199	3,5
A & G Amati 1625	12	18,9	351	10,7	199,7	3,5
A & G Amati 1595	11	19,4	360	11,1	207	3,5
A & G Amati 1596	12	19,0	353	11,0	204	3,5
Andrea Amati ca. 1577	11	19,0	353	10,8	201,5	3,5
Andrea Amati Charles IX	15	18,9	351	10,8	200	3,5
J. Stainer 1659	16	18,9	351	10,8	200	3,5
J. Stainer 1650	16	19,0	353	10,7	199	3,5
J. Stainer 1671	16	19,0	354	10,9	202	3,5
J. Stainer 1678	16	18,9	351	10,6	198	3,5

A. Stradivari 1713	17	19,0	353	11,1	205,5	3,5
A. Stradivari 1709	17	19,1	356	11,2	207	3,5
A. Stradivari 1707	17	19,0	353	11,2	207	3,5
A. Stradivari 1692	17	19,5	362	10,9	202	4
A. Stradivari 1694	17	19,4	360	10,8	200	4
A. Stradivari 1715	17	19,1	355	11,1	207	3,5
A. Stradivari Hellier	17	19,1	356	11,2	209	4+3,5
A. Guarneri 1662	12	19,0	354	11,0	204	3,5 to 90%
P. Maggini	11	18,8	350	10,9	203	3,5
A. Guarneri 1681	12	19,0	353	11,0	204	3,5
A. Guarneri 1662	12	18,9	352	10,9	203	3,50
Guarnieri Del Gesu Doubleday	19	19,0	354	11,0	204	3,5
Guarnieri Del Gesu Haddock	19	18,8	349	10,9	203	3,5 to 80%
mean value		19,00		10,95		

other sizes						
Girolamo Amati 1604	11	18,3	341	10,5	195	3,5
Andrea Amati ca. 1574	11	18,4	342	10,5	195,5	3,5
A. Guarneri Viola 1664	14	25,9	481	0,0		5
J. Stainer Viola 1660	16	21,7	403,5	12,7	236	3,5

r lower bout	distance lb r	distance ub r	center of lower f-holes	distance center-bridge
-	-	-	-	-
4	1,5	2,90	42,0	2,26
4	2,0	3,00	40,0	2,15
4 and 4,5	2,0	3,00	42,0	2,26
4	1,6	2,75	44,0	2,37
	2,1	3,24	42,0	2,26
4	2,0	3,00	44,3	2,38
4	1,8	3,00	38,8	2,09
4	1,7	2,75	43,6	2,34
4 to 90%				
4 and 8	1,7		42,5	2,28
4				
4 to 95%	1,8	3,00	42,0	2,26
4	1,7	2,75	42,0	2,26
4	2,0	2,90	42,0	2,26
4			34,0	1,83
4			35,0	1,88
4			33,0	1,77
4			37,0	1,99

4	2,0	3,00	42,0	2,26
4	2,0	3,00	42,0	2,26
4	2,0	3,00	42,0	2,26
4	0,5	2,76	37,0	2,0
4	0,5	2,75	38	2,05
4	2,0	3,10	42,0	2,26
4	2,0	3,20	40,0	2,15
4	2,0	3,00	40,0	2,15
4	2,0	2,80	42,0	2,26
4 to 90%	1,8	3,00	43,0	2,31
4	2,0	3,00	42,0	2,26
4	2,0	3,00	40,0	2,15
4 to 60%	2,0	3,00	42,0	2,26
			40,6	2,18

3,5 and 4	1,5	3,50	39,0	2,10
3,5 and 4	1,5	2,33	40,8	2,19
5,5	3,0	4,00	53,0	2,85
4			42,0	2,26

Table 2 36 violins investigated with the Roman oncia showing the mean length of 19 Roman oncia and the maximum width of 11 Roman oncia. [6]; grey values differ most from mean value.

References

- [1] A. Bagatella, *Regole per la costruzione de violini, viole, violoncelli e violoni*. Padua: (n.p.), 1786.
- [2] K. Coates, *Geometry, Proportion and the Art of Lutherie*. Oxford: Oxford Univ. Press, 1985.
- [3] F. Denis, *Le Traité de Lutherie*. (n.p.): Aladfi, 2006.
- [4] H. Heyde, *Musikinstrumentenbau: 15.-19. Jahrhundert: Kunst, Handwerk, Entwurf*. Leipzig: VEB Deutscher Verlag für Musik, 1986.
- [5] G. O'Brien, "The use of simple geometry and the local unit of measurement in the design of Italian stringed keyboard instruments," *Galpin Society Journal*, vol. 52, pp. 108-171, 1999. Available: <http://www.claviantica.com/geometryfiles/Italiangeometry.htm>.
- [6] S. Regina Zopf, "Critical study of the use of a length unit in the design of the 16th to 18th century Italian violins," *Journal of Cultural Heritage*, vol. 27, Oct. 2017.
- [7] H. Arnaut, G. Le Cerfand E.-R. Labande, *Les Traités d'Henri-Arnaut de Zvolle et de Divers Anonymes* (Paris: Bibliothèque nationale, MS. latin 7295). Kassel: Bärenreiter, 1972.
- [8] Technical drawing of the GAL, Guild of American Luthiers
- [9] F. Galeazzi, *Elementi Teorico-pratici di Musica, Con un saggio sopra l'arte di suonare il Violino*. Rome: Stamperia Pilucchi Cracas, 1791-1796 / Ascoli: (n.p.), 1817.
- [10] R. Bletschacher, *Die Lauten- und Geigenmacher des Füssener Landes*. (n.p.): Friedrich Hofmeister, 1978.
- [11] T. Mace: *Musick's Monument*. London: T. Ratcliffe & N. Thompson, 1676, p. S. 246.
- [12] Poster of The Strad. London, Newsquest Specialist Media.
- [13] Technical drawing, National Music Museum, Vermillion, SD.
- [14] A. Zanrè, *The Girolamo Amati Viola of the Galleria Estense*. (n.p.): Scrollavezza e Zanrè, 2014.
- [15] R. Hopfner and J. Stainer, *...kayserlicher diener und geigenmacher zu Absom*. Vienna: Kunsthistorisches Museum, 2003, p.65.
- [16] Technical drawing, Kunsthistorisches Museum, Vienna, Sammlung Alter Instrumente.
- [17] www.theluthierslibrary.com.
- [18] J. S. M. Bouquet, technical drawing, 2016.
- [19] <https://philharmoniedeparis.fr/fr/musee-de-la-musique>.
- [20] Technical drawing, Germanisches Nationalmuseum, Nuremberg.

Sibire's Aesthetic Sensibility: Stradivarius, the Classical Ideal and a New Noble Purpose

CHRISTINA LINSENMEYER

University of the Arts Helsinki, Sibelius Academy, Finland

Abstract

In his *La Chélonomie, ou, Le parfait luthier* (Paris, 1806), Sébastien-André Sibire designates the early violin-making canon with Antonio Stradivari at its apogee, and promotes imitative practice in the classical tradition. This paper uncovers how, in the new context of the aesthetic regime, Sibire rhetorically illuminates three key concepts: the category of art, the Ideal of the artist, and the experience of the aesthetic. Under the cover of his violin-making and -restoration treatise, he promotes an agenda to reunify the Sciences and Arts, and justify violin-making among the newly established *Beaux arts*, with violin-makers as genius artists, and violins as art objects.

Using a cultural-historical approach, this paper critically confronts the violin's transcendent status and violin-making's hierarchical canon, demonstrating how Sibire's views are interdependent with particular ideological and sociological circumstances. The findings are relevant to violin-making history, organological scholarship and museum practices.

1. Introduction

Recent developments in the conservation of wooden musical instruments include state-of-the-art technologies and procedures. Many of these techniques have been applied to study and restore “fine” old violins, particularly by Antonio Stradivari. This paper does not directly address these developments, but asks about the history of restoration, and the underlying foundations of the aesthetic preferences that have led us to conserve and particularly prize old Italian violins in the first place. Museums place a high value on old violins, “classic” objects worthy of extensive restoration and exhibition. The canon has been so central to the value of violins that this hierarchical system has been accepted largely unquestioned as an indisputable aesthetic matter, and this acceptance has distorted our perspective of violin and violin-making history. In order to understand the meaning and role of the canon and its value, we must challenge the discursive authority by critically looking at violin-making’s formative discursive ideologies and judgments.

In the literature, these preferences first appear in detail in Sébastien-André Sibire’s *La Chélonomie, ou, Le parfait luthier* [“Chelonomy, or, The perfect violin-maker”] (Paris, 1806). Sibire (b. Paris, 1757 – d. Paris, 1827) was a priest (*Abbé*) who was also a violin amateur and violin collector who frequented the shop of Nicolas Lupot (b. Stuttgart, 1758 – d. 1824), arguably the foremost violin-maker in Paris at the time. Sibire developed a fanatic admiration for the instruments by old Cremonese luthiers. In his introduction, he explains that he took notes on what Lupot had to say about old luthiers and their instruments, and Sibire contributed where he could [1, p. 5–6], covering both “theory and practice” [1, p. viii]. Their cooperative treatise formalizes a violin-making canon, placing Antonio Stradivari (1644–1737) at its apogee; it also arguably marks the formalization of the discipline of violin restoration to cater to new performance-practice demands. Unlike other orchestral musical instruments, violins were not replaced with innovative, mechanized models; the violin remained continuously in use, undergoing modifications, and continued to be used in a modern context, made possible by restoration techniques.

Despite the emergence of a new sociological understanding of the arts [2], and the emergence of “new” histories in many fields, current scholarship and museum practice have failed to overcome the violin’s transcendent status and violin-making’s hierarchical canon. Scholarship has shown that “views of canonic status are contingent on historical circumstance” [3, p. 396]. The postmodern age bears witness to the loss of the canon’s singular authority [4–6], and studies explain how nothing can be marginal [7, p. 229], and how the value of “masterpieces” changes over time [8]. What remains to be seen are sufficient critical accounts of violin-making’s canonic discourse that acknowledge and examine the influence of historical circumstances on values, preferences and practices.

Recent research has explored how Sibire’s text, steeped in post-revolutionary nationalism, is clearly reactionary to various socio-political circumstances, and functions as a politicized nationalistic grand narrative of violin-making that promotes the supposedly universalist history of violin-making and the old, “Italian” paradigms [9]. Sibire’s politics are overt, for instance, with his graphic, extended metaphor depicting the violin soloist as a Revolutionary hero and emancipatory leader. His politics are also somewhat less overt, as in his socio-politically infused description of an excellent violin’s four qualities: quality, liberty, equality and force. He continues: “. . . If a single and unique model meets all these to the final degree, it alone is legitimate (*légitime*), and the others are bastards (*bâtards*)” [1, p. 44].

Although the political and aesthetic are inextricably intertwined, it will be useful to take a closer look here at aesthetic context in order to better understand Sibire’s text and its meaning, as well as its relation to cultural value and social power¹. Sibire describes his treatise, on the beautiful (*beau(x)*) models of the great masters, as “classic” (*classique*) [1, p. 32]. Yet, the concept of classicism in the aesthetic sense are, as Dahlhaus points out, “equally suspect, and the notion that significant works of art stand out from history, preserving their aesthetic content independently of the historical context in which they originated, is metaphysically naïve” [11, p. 61].

Challenging transcendent canons and historical “Great men–Great Work” methodologies with a critical, cultural-historical approach, this paper rests on the established ideas that artistic and cultural value, as well as discursive structures (including of aesthetics), change over time. As a contextual reading, it realizes how Sibire’s ideas and values are *interdependent* with contemporary categorizations, ideologies, and historical circumstances [2, p. 32]. In tandem with historical circumstances, it accepts that what have been called “contingencies of value” (i.e., that “characteristics of a work’s reception overlap substantially those characteristics that may impart value to the work”) undermine the conservative defence of the canon, particularly in terms of what is commonly called “the test of time”.²

Further, this analysis recognizes that “certain concepts and ideals ‘regulate’ artistic practice” and that “these regulative concepts and ideals of art and social systems of art are reciprocal” [12, p. 11]. It is aware of the historical remoteness [11, p. 60] of Sibire’s text – that, like all ideological and aesthetic opinion of the past, Sibire’s reception of old violins is socially and historically located [2, p. 43].

1 Cultural meaning and function cannot be separated from power [10, p. 327].

2 Everist [3, p. 392] on B. H. Smith’s “Contingencies of value”, *Critical Inquiry*, vol. 10, pp. 1–35, 1983.

This paper argues that Sibire’s writing, clearly grounded in a western-European Sensibility of 1806, engages with various ideologies, particularly in light of a paradigm shift—the new realm of the aesthetic regime [12, 13]. Sibire’s treatise has an agenda, which has political, aesthetic and social interests. This paper will focus on his aesthetic agenda, which uses violin-making to justify the reunification of the Sciences and Arts while aiming to establish violin-making among the newly established *Beaux arts* (Fine Arts). Under the cover of his violin-making and restoration treatise, he rhetorically illuminates three key concepts: the category of art, the Ideal of the artist, and the experience of the aesthetic.

2. Sibire in the Aesthetic Regime: Confronting Horace’s Precept

In his opening *Avertissement*, Sibire clues us in to his agenda when he states that he is writing against “Horace’s precept”, which he humbly says is a burdensome undertaking beyond his strength, but he is the herald of “new truths” (*vérités nouvelles*) [1, p. vi]. Although he does not specify the precept, Sibire, like many early writers on aesthetics, is engaging with Horace’s *Ut pictura poesis*. An analysis of his text demonstrates that he disagrees with Horace’s precept primarily on the nature of art: art is no longer *representational* (i.e., pictorialism imitating nature) as it had been for about two millennia, but *aesthetic*. In the previous representational regime [13], art was utilitarian, always in the service of a contextual function. Art in the aesthetic regime, however, is newly appreciated outside of any context [12, p. 3]. As such, when considering the visual (and aural) characteristics of violins, Sibire writes: “It is an affair of taste (*goût*)” [1, 100].

We can observe that, in the new light of aesthetics, Sibire engages in the two main topics of the long-standing *Querelle* of the Ancients and Moderns: 1) the relative merits of modernity in relation to the classical past as a kind of competition [14, p. 14, 474], and thus intertwined with various theories of progress; and 2) the division (i.e., separation) of the Sciences and Arts, effective between about 1750 and 1800 [12, p. 3]. These so-called “quarrels” persisted in different waves from the seventeenth to the twentieth century [15].³ Although the debates began primarily over literature, France and England saw battles regarding the plastic arts in the eighteenth century. The aesthetic regime of art is indeed considered to be a product of the *Querelle* of the

3 We can see explicit evidence of the violin-making discipline acknowledging these quarrels into the twentieth century, for example, with P. Kaul’s *La querelle des anciens et modernes: Lutherie italienne ou lutherie française?* Nantes: Imprimerie de Bretagne, 1927.

Ancients and Moderns, and its offshoots. Further, Patey demonstrates the discursive separation of the Sciences and the Arts, quoting Hazlitt’s 1814 view that scientific pursuits (those “mechanical, reducible to rule or capable of demonstration”) were “progressive”, while artistic ones (depending on “genius, taste, and feeling”) were stationary or “retrograde” [15, p. 20–21]. Sibire is writing during a time when the conflict between artistic and scientific views was oppositional and quite divisive, and early-Romantic thinkers aimed to reunite these disciplines on the basis of a common ideal—beauty.

The category of Fine Arts is a recent construction, and the development of the “aesthetic” as a scientific discipline arguably began in 1735 when Alexander Gottlieb Baumgarten coined the term. The second half of the eighteenth century, in particular, saw the separation of the aesthetic experience from other types of experience, and crafts from a new arts designation [12, p. 75]—the *Beaux arts* (Fine Arts, literally “beautiful arts”) including poetry, painting, sculpture, architecture and music. Violin-making needed to make a case for its inclusion since the formerly interchangeable words of “craft” and “art” were newly in opposition to each other. Also defined by their opposites were two additional “fateful divisions”: the artist vs. the craftsman, and a special, refined pleasure of the Fine Arts vs. ordinary pleasures [12, p. 5–6]. In tandem with the establishment of aesthetics as a discipline, the new “Fine Arts” were exalted, as “a matter of inspiration and genius meant to be engaged for themselves in moments of refined pleasure”, over crafts and popular arts that required only skill (*techne*) and were “meant for mere use or entertainment” [12, p. 5]. Charles Batteux (*Les beaux arts réduits à un même principe*, 1746) is now credited with defining the first system of the Fine Arts in 1746 [16, 29, 4]. This new system circumscribed the domain of objects, to which aesthetics could be applied [17, p. 4], and objects for the first time began to be aestheticized.

2.1. The Classification of Art

2.1.1. Unification of the Sciences and Arts

Sibire promotes the unification of the Sciences and Arts by identifying violin-making as *both* an “exact science” where “nothing is arbitrary” [1, p. 36] and an “Art” characterized by sentiment and feeling—both being governed by rules or laws. Correlatively he calls violin-makers “doctors” and “surgeons” [1, pp. i, 135–136]. The violin is both a masterpiece and a machine; it has a “noble simplicity of construction”, yet such “complication in its details” [1, p. 16]. Violin-making takes time to improve, and requires, exclaims Sibire, “the pains of research! As much as the searching of trials!” [1, p. 16]. Invention and innovation were paramount aims in the new industrial arena [18]. In this light, past makers, including the Amatis and Stradivari, were lauded as *innovators* of their own time [1, 19] and the

violin is the “the *ultimatum*, the *last word* of human industry” [1, p. 22].⁴ Further affirming a unification of art and science, Sibire also designates violin restoration an “art” [1, p. 122], while at the same time, he presents notable new “discoveries” of restoration.⁵ For new making, he simultaneously promotes invention *and* artistic practice based on imitation of “antique perfection” [1, p. 152]. Sibire simultaneously looks backward to antique tradition while looking progressively forward with the unity of the sciences and arts. Although Sibire recognizes violin-making as a science, his treatise emphasizes violin-making as an Art, including its corollary violin-maker as artist, and the violin as an aesthetic object.⁶

2.1.2 Violin-Making as an Art: Canon and the Classical Ideal

“No, lutherie is not simply a trade (*métier*), it is an art”—a “beautiful profession” [1, pp. 115–116]. Sibire states, as for poetry and painting, that music is regarded with reason as a “worthy rival of these two arts” [1, pp. 14–15]. He refers to the recent glorious rise of instrumental music, emancipated from the voice (i.e., not needing to serve a text), with “harmony and melody embracing as sisters” (i.e., embracing equally rather than a hierarchy favouring melody). Further, Sibire gives violin-making a longer establishment than music, writing that, prior to the rise of instrumental music, while music “slept”, “lutherie watched over her, and sowed pearls under her feet” [1, p. 23].

Sibire places violin-making within the realm of Fine Arts production by providing a canon and a working method in the classical tradition. In the Fine Arts tradition, canons (the type with a distinctly historical character comprised of exemplary models of status) were established starting in the eighteenth century, particularly in France and England. Sibire joins violin-making with this discursive trend.

From an intellectual perspective, Sibire’s treatise works to increase outreach to the “curious” public [1, p. i] for acceptance, even beyond

4 At the French national fairs, musical instruments in general were classified in the “Mechanical Arts” with clocks and mathematical and physics instruments. By 1827, at the fairs, “Musical instruments” was an independent category and newly designated as “Luxury objects” along with gold- and silver-smithing, and other fancy articles [18].

5 Two of his three discoveries relate to restoration: the restoration of collapsed archings, and the restoration of antique varnish. The third is the invention of spun strings [1, pp. 144–152].

6 Patey explains that Coleridge’s attempted program to unify the arts and sciences in order to heal literature’s old split between the Ancients and Moderns was thwarted by his “continued adherence to that other product of the battle between the ancients and moderns, the aesthetic theory of art” [1, 15].

violin-makers. Weber, in his analysis of the late development of the musical canon, demonstrates components necessary for the development of a canon, including an *intellectual* basis, and one in the form of a *printed* commentary. To create such an intellectual base in his publication, Sibire covers all three subjects of Kant’s 1790 secular redefinition of the traditional contents of western philosophy’s three autonomous domains: science, morality and aesthetics [1, p. 14; 20].

A canon also requires historical models and practical rules. Violin-making, like painting, had no relevant ancient models, so models were chosen from the High Renaissance and early Baroque. The canon also requires a unified practical method. In 1806, Sibire establishes a violin-making canon and a corresponding imitative practice for new violins based on old Italian models in the classical tradition. Sibire begins his treatise, “It is only for a master of art to fix principles” [1, p. i]. As the core of the text, Lupot provides “eight main principles of indispensable knowledge” [1, p. 34] derived from “the beautiful (*beaux*) models of the great masters” [1, p. 32]—these “rules are determined by exact proportions, which are exact in themselves” [1, p. 33]. Sibire explains:

If a competition (*concours*) had been organized in [Stradivari’s] century where the great master luthiers were all compared with their masterpieces, the five Amatis would have earned honourable mention; Steiner would have earned merit straightaway; and with a single voice, Stradivarius would have taken the prize. / Such are the seven [ancient] sages of lutherie, the seven lawmakers of art, of whom the first six are only admirable, each in their genre, while the last is perfection itself [1, p. 98].⁷

Sibire adds a sacred tone: “Their laws (*lois*) and their oracles (*oracles*)” are engraved on the wooden tables of their violins [1, p. 32]. As is characteristic of canons, Sibire’s is both ancient *and* natural; he explains: “These are fundamental principles from which it is never permissible to depart, because they are immutably held, not by opinion but by nature” [1, p. 28]. Sibire thus establishes a hierarchical canon; Stradivari himself “wins every hand”—*omne tulit punctum* [1, p. 98].⁸ Sibire’s identification of a “competition” is significant because it implies a judge and aesthetic judgment.

7 Seven sages appear in various mythologies, including those of ancient Greece.

8 Sibire’s italicized Latin quotation (*omne tulit punctum*) comes from the same text as Horace’s *Ut pictura poesis*, the full line reads: “Omne tulit punctum qui miscuit utile dulci, lectorem delectando pariterque monendo” [He wins every hand who mingles profit with pleasure, by delighting and instructing the reader at the same time]. (Horace, *Ars poetica*, or *The Epistle to the Pisones*. Lines pp. 335–337, trans. E. C. Wickham).

Sibire expresses his distaste about the variety of violin models currently being made, complaining that “routine is everything and reason nothing”, to a displeasing end [1, p. 34]. He sees a need to unify practice, for the sake of taste, and so establishes rules for the maker to follow. For imitative practice, Sibire must select a model and provide a method for making, one that incorporates reason. The model Sibire chooses is based on a classical ideal, as it is the Ideal that was worthy of imitation. This aim is connected to the circumstances, particularly in the second half of the eighteenth century, which saw an unprecedented historical consciousness due to archaeological excavations and the artefacts uncovered [14, pp. 19–20; 22, p. 198]. Although neither archaeology nor history had yet established a scientific basis in the eighteenth century, proponents hoped that “the uncovering and publicizing of antiquities (...) would lead to a ‘true style’—which we know as Neoclassicism” [21, p. 198]. Likewise, according to Sibire, violin-makers asked, amid the “infinite combinations” for creating a violin, “how to determine or discover the true form” (*la forme véritable*) of the violin [1, p. 16].

Rather than finding a true style in a single exemplar, it was an Ideal of the antique model that became the model. The impact of ideals is evident, for example, in early-modern imitation of antique sculpture, persistently idealized as pure white rather than its historical polychrome. Further, in line with classical tradition, Sibire’s model was also “typical”.⁹ Sibire gives certain guidelines or even specific measurements for certain elements of violin-making. However, a single measurement, as provided, for example for model size, stands for all large Amati instruments and all Stradivari violins [1, p. 45]. Such generalization necessitates a kind of averaging based on a multitude of originals. Sibire then justifies his method in a way what we could call the Goldilock’s approach, that is: not too much, not too little, just right. His measurements, presented as scientific basis, are not very scientific at all, but *typical*; they are an aesthetic ideal. Greenhalgh explains, concerning Joshua Reynolds’ late-eighteenth-century discourse on Ideal Beauty for poetry, “The artist has formed the true idea of beauty, which enables him to give to his works a correct and perfect design”, while the artist’s imagination is inspired by the “best productions of antient (sic) and modern poetry” [21, pp. 16–17]. In this way, the artist’s *Idea* is the origin of an *Ideal*.

To further solidify violin-making as a Fine Art, Sibire expounds on elemental dichotomies historically relevant to the Fine Arts: 1) Authentic

vs. fake, 2) Original vs. copy, and 3) Good vs. bad [22, p. 144]. Sibire, a self-identified collector [1, pp. 69–71] and man of educated social standing (an *Abbé*), would have been well-versed in these dichotomies relevant to connoisseurship. With these dichotomies, Sibire reinforces his canon, which exists because of its exclusionary nature. For example, Sibire judges good violins in comparison to bad ones, namely those of German origin [1, p. 62] as well as the “junk” (*pacotilles*) of the French provinces [1, p. 58], particularly the “detestable” Mirecourtian violins [1, pp. 116 and 41], and not surprisingly in light of political-economic circumstances, he leaves out British violins all together. He also criticizes uncreative makers who “servilely” and “indistinctly” copy the “qualities” (to the “minutest” detail with “exactitude”) of the old instruments *as well as their “faults”* [1, pp. 112–113]. In contrast to “a true luthier” (*vrai luthier*) [1, p. 118], such “carpenters of the violin”, are “so-called luthiers” who sacrifice “art” for “profit” [1, pp. 112–113].

Sibire is extensively vocal about fraudulent practices, which he deems to constitute “profound immorality”. He discusses the “accursed trinkets” of “precocious maturity” that have had their plates problematically thinned to make them sound more mature; these instruments are “physical monstrosities” and a “moral robbery”. Such cupidity (*luthier cupids*) distorts (*dénature*) a violin’s true (*vraies*) thickenesses to make a new violin that artificially and unnaturally sounds like it is 100 years old. Such “knavery” and “roguery” yields “pitifully degrading” instruments that are short-lived, and are “almost nothing for the buyers and totally lost to their heirs”. Sibire contrasts these provincial fraudsters with Parisian luthiers, who are “advantageously known for their probity [i.e., strong moral principles and honesty] and their talents”. All types of Sibire’s “crook” (*escroc*) are a foil to his *parfait luthier* in moral conduct and artistic practice [quoted words in previous passage: 1, pp. 51–53 and 58]. His diatribe against these problematic practices is not simply for descriptive purposes, or only to separate Lupot and makers of integrity from the scandals; it has a higher purpose of prescribing what practices *are*, and *are not*, morally acceptable for the violin-maker in the face of the recently established and growing open market. Correlatively, the musical canon (for composition and performance) held a moral dimension, which grew from a reaction against commercialism (against developments of publishing and concert life) that were seen as manipulative and threatened standards of taste; Weber has termed this critique against commerce’s degradation of musical values “musical idealism” [24, p. 352].

Further, as Greenhalgh [21, p. 200] has pointed out for literature, the international nature of Neoclassicism and nationalism was a successful arena for forgers (e.g., James Macpherson’s 1761–1763 poems of Ossian). Similarly, with violin-making, for which a taste for the past, an international market for old objects, and little regulative precedent

9 Greenhalgh sets the tenets of classicism as a concern with antiquity, with the ideal, with the typical, and with morality in the widest sense—in the context of the civilization which gave it birth [21, 23].

created much spurious activity to which Sibire is reacting. It was the task of the connoisseur to identify the few “masterpieces” (*chefs d’oeuvre*) [1, p. 54] from among the numerous fakes, as well as judge increasingly “rare”, artistic “models” (artistic) from the increasingly “abundant”, unimaginative “copies” (*contrefaçons*) [1, p. 93]. As such, Sibire pointedly differentiates true connoisseurs from the “crowd of half-connoisseurs” (*foule de demi-connoisseurs*) [1, p. 58].

For Sibire, the original old violins are deemed worthy of extensive restoration, denoting their high value. He declares that “lutherie is perhaps the only trade in the world where the old (*vieux*) is more esteemed than the new, and maintenance (*l’entretien*) is more difficult than building (*la bâtisse*)” [1, p. 123]. Despite such recent brutal times, he states, the violin’s body is not destroyed; this is where the violin differs for Sibire from other musical instruments—due in part to its “supreme quality” [1, p. 22], he claims it does not fall to degeneration due to time (though he seemingly contradicts himself elsewhere, as discussed below). Further, he writes: “The violin, on the contrary, when it is perfectly organized by man, it is at the same time adopted by nature. It forms, with the other members of its family, a privileged caste. (...) In a word, it gains as much and more than [other instruments] lose, and its perpetual growth is so marked, that if the material could be immortal (*immortelle*), one would be tempted to believe that this progress extends to infinity” [1, p. 21]. Finally, in the hands of the restorer, who can replace the bridge and the bass bar [1, pp. 68–71], the old violin, is a “Phoenix ... of the universe”, capable of being transformed and reborn [1, p. 71]. This is not simply *ravèlement*, but something akin to the supernatural. With restoration, the transformed old instruments gain transcendence; beyond their material form, Sibire gives the old-master models a spiritual quality, even likening one restored Stradivari violin to Raphael’s *Transfiguration* [1, p. 69], installed in the Louvre at the time, and one of the most noted masterpieces of Napoleon’s war-looted art.

For Sibire, it is necessary for violin-makers to create new masterpieces, since, he admits, Time cannot be stopped and the old instruments are in reality (rather than spirit) not immortal. He exclaims: “What is it in his power to eternalize them! Unfortunately the thing is impossible. Time, which undermines everything, will take over in its course, first the originals of the famous artists, then the most beautiful copies of their imitators; and lastly, century-by-century copies of copies”. He encourages that the old models must live on in some aspects of some new works, which will, in turn, serve as the new models. In this way, “at least some of its too fragile monuments (*monuments*) will continue on to all future ages” [1, p. 153]. Sibire realizes that it is the Ideal that is transcendent and timeless, not the material objects.

For him, creative imitative practice is the path of progress always improving, rather than increasingly declining: “May they be worthy: may, by perfecting them forever, may ‘Chelonomy’ extend its duration to that of the centuries, and survive to universal consumption!” He ends his text, recognizing violin-making as an old “art of utility” combined with the new “art of luxury”, “purely charming”, “superfluously delightful” and “so necessary for pleasures (*plaisirs*)”. And he confirms that his method will ensure the eternal subsistence of violin-making, which “originated in the cradle of the world; and will cease to exist only by being buried and dying with those [other arts] in the grave of the world itself” [1, p. 153].

2.2. *The Ideal Violin-Maker: Genius and the Ideal Man*

Along with the new separation of “art” and “craft”, the terms “artisan” and “craftperson” were no longer interchangeable [12, p. 5]. The question arose: Is a violin-maker an artist or merely a craftsperson? Sibire describes that the “luthier works to the ideas and taste of the artist” [1, p. 16]; he identifies Lupot as a “distinguished artist” [1, pp. vii–viii], and violin-makers—old and new—as artists.

In the spirit of Winckelmann’s [25] idea that artistic imitation *imitates* but does not *copy*, Sibire instructs students not to “copy blindly”, because “in imitating, one does not stop being oneself”. Sibire clarifies: “To create through imitating, therein lies the perfection”, and is what makes the great difference between a purely mechanical worker (*ouvrier purement machinal*) and the intelligent artist (*l’artiste intelligent*) who reasons his work” [1, p. 28]. He thus promotes *creative* imitation, rather than slavish, *exact* imitation. Sibire defines the “perfect luthier”:

It will be he, who, after the processes of the ancients, and the wise comparison of their different manners, avoiding their faults, will best grasp the true (*vrais*) principles, and apply them more accurately; one whose works will be reasoned (*raisonnés*) with depth, and modelled with as much intelligence as taste (*goût*) on the most beautiful (*beaux*) models of antiquity [1, pp. 109–10].

In the late eighteenth century, the ideology of autonomous aesthetics was closely allied to an aesthetic of genius and the notion of originality as a kind of philosophical legitimization: the arts existed because of genius [11, p. 147]. Sibire explains that Stradivari, around 1700, “searched for the most perfect model and found it in his genius” [1, p. 94]. In 1806, the emphasis on industrial progress, prizing innovation (necessary for authenticity), along with “the veneration of genius, i.e., with the thesis that products of genius stood apart from history” [11, p. 148], combine in Sibire’s Romantic yet industrial image of A. Stradivari as an inventor-genius.

Sibire, in line with classical tradition, endows his artistic geniuses with heroic traits derived from the Classical Ideal Man. It is not insignificant that Sibire points out that his book is not simply titled as a *violin-making* method [1, p. vi]. Instead, we can recognize that his title concerns the “perfect luthier”, an Ideal man, arguably Aristotle’s Ideal Man, who demonstrates the heroic and divine. Like the ancient epics, Sibire’s treatise can be seen as a moral, intellectual and practical guide. It corresponds to works of “pleasurable didacticism, conceiving the Aristotelian universal as examples of virtue and vice for imitation and avoidance” [1, pp. 314 and 473]. Sibire’s *parfait luthier* (and even Sibire himself as a connoisseur) is a paragon, an *exemplum virtutis* (i.e., an example of virtue worthy of imitation). Like Sibire’s luthier, Aristotle’s Ideal Man also searches for truth, as depicted in the “acme of classicism”—Raphael’s *Stanza della segnatura* in the Vatican, depicting, in the life of man, the four ways to search for truth: Artistic, rational, divine (i.e., spiritual), and moral. Sibire’s presentation of his “new truths” [1, p. vi] includes all four of these aspects. Given philosophical writings at this time, we can understand the luthier’s quest for truth in a moral context because Sibire’s violin-maker uses reason. Rather than unreasoned “routine”, the violin-maker’s method is a Kantian self-actualized search for truth, incorporating imaginative power and freedom. Practicing creative imitation constitutes a moral and virtuous path. Further, Sibire also presents morality as a code of conduct or action when he judges the “*luthier cupids*” and their unartistic, unvirtuous and immoral practices. Beyond the *parfait luthier*, Sibire identifies traits of Other luthiers: incompetent, lazy, or dishonest [1, p. 51].

In the late eighteenth and early nineteenth centuries we see the specific rise of the related “cult of genius” applied to artists and other creators, perhaps most famously to Beethoven. Swafford defines “genius” in this period as a “transcendent spirit” [26, p. 146].¹⁰ Sibire, regarding canonic makers, formally instigates a sort of cult of genius (*culte*) [1, p. 109], that is, a group of people showing great devotion to and veneration of a person, qualified as a genius, who is idealized and made heroic. Sibire, about the seven canonic makers he identifies, exclaims:

What do I say! Penetrated by respect for them and their works, let us bow before their ashes, and let us be grateful enough, fair enough, above all to the seven *premier* artists, to honour their glorious memory with a kind of worship (*culte*); but never forget that the only tribute worthy of great men consists of learning from their lessons and imitating them [1, p. 109].

10 Swafford [26, p. 126] further distinguishes between eighteenth and nineteenth-century conceptions of genius as “transcendent spirit”.

2.3. The Experience of Aesthetic Art: A New Noble Purpose

Sibire describes a new noble, that is, universal,¹¹ purpose of music and violin-making: the pleasure (*plaisir*) found in the aesthetic experience for the listener and viewer. Indeed, in 1719, well before the term aesthetic was coined, Dubos [27] used (Fr.) *plaisir* for “beauty” [28, p. 284, fn. 18]. Sibire’s 1806 *plaisir*, resulting from aesthetic contemplation, confirms music among the Fine Arts versus merely the agreeable arts (Kantian *arts agréables*), simply for entertainment or distraction. (This dichotomy is the origin of the distinction between High art vs. low art.) Both Kant [20], as well as other philosophers, and Sibire include reason as a component in *plaisir*. Further recalling Kant, Sibire discusses the “innocent pleasure” (*innocent plaisir*) and also the “pure and moral” and “privileged” enjoyment (*jouissance*) that the listener experiences with music [1, pp. 14–15].

Sibire also touches on a more obscure and undeveloped aspect of Kant’s aesthetic theory. Kant [20] does not wholly separate art from purpose (though critics later overstated such a separation by Kant [29]). Kant’s art value is intrinsic, but he also expresses art’s “instrumental” value, which has a special purpose (outside of the purpose or utility of the art or object) of a kind of social communication, though Kant did not yet know the purpose of this [29, pp. 43–44]. In fact, Sibire exemplifies this “instrumental” value for music, including violin-making, when explaining the social role of music, the violinist and the violin towards Revolutionary aims [1, pp. 24–25], as well as in “this new manner of expressing thoughts” with instrumental music, that “brings together and connects talents, fraternising men and the arts” in experiences of aesthetic enjoyment and pleasure [1, p. 14].

And inversely, while the arts are a pleasure for civilized society (i.e., in contrast to “*l’état sauvage*”) [1, p. 15], following Kant, Sibire states “society for the arts is more of a necessity than a pleasure” [1, p. 15].

Yet Sibire also presents a controversial element of Kant’s aesthetic theory—“disinterested” contemplation, an aesthetic experience that does not entail reason, but is based purely on intuition or sensation. By “disinterested”, Kant also refers to a “disconnection from the rest of human concerns” [9, 15]. This type of aesthetic experience is arguably a more transcendent type, since it removes all sense of purpose, but is the pure judgment of true beauty. Disinterested contemplation allows for an arguably even higher aesthetic experience, because it transcends reason.

11 Sibire uses “noble” in a context that means “universal” when discussing the purposeful quality of Lupot sharing his method publicly [1, p. viii]. In this context “noble” has the quality of universality combined with implications of an intent towards truth. It is, of course, also bound with Sibire’s privilege and his bourgeois agenda.

Sibire does not exclude the utility of the violin, however the utility serves a new purpose, it is now relative to aesthetics—the work of the old masters is not simply useful for playing music, it is useful for aesthetic pleasure (*utile à nos plaisirs*) [1, p. 23]. In his treatment of violins, Sibire does emphasize the utility of violins for musicians and composers. Sibire uses the violin’s utility to justify his “genealogy” of three musical arts: violin-making, music compositions and performance; and despite his affirmation of the need for musical-arts solidarity, he argues the priority of violin-making over the other two, as violin-making provides the means for them to exist [1, p. 15]. At the same time, Sibire recalls the theory of disinterestedness, not directly, but in relating his own and Lupot’s personal judgments about violins. For Sibire, the most perfect violins, in themselves, are objects of delight and beauty. Sibire treats violins, particularly the “great models” (*grands modèles*) of Stradivari [1, p. 70], as objects of disinterested contemplation, describing them as universal objects of beauty, worthy of collections and extensive restoration. Sibire explains that it is impossible to decide whether “beauty” or “excellence” prevails in these “sublime” violins. He goes on to describe them with superlatives; they are “beautiful like a star” with one restored being the collector’s “apple of the eye” (*la prunelle de l’oeil*), unique on earth [30, 70–71]. He insufficiently lists their seductive visual elements: “purfling, neck, corners, purfling points treated in perfection” [1, p. 71]. Their sound, as yet, Sibire explains, does not match their visual beauty, but since such an instrument “cannot be bad by nature”, but has a “pure heart” (*coeur net*), replacement of the bass bar according to Lupot’s new calculations will allow for the Phoenix’s “song” (*ramage*) to match its “plumage” (*plumage*) [1, p. 71]. Then, according to Lupot and Sibire (*selon lui et selon de moi*), it can reside as a guest “in all the violin cases of the universe” [1, p. 71]. Sibire and Lupot, of course, have potential self-interested motivations to promote such ideas.

The aesthetic experience, particularly “disinterested” contemplation, is inherent to the privileged and leisurely collector–connoisseur lifestyle. Kantian disinterested contemplation, and the aesthetic autonomy that it promotes, can be seen as “a specific product of the leisurely ways of life of members of the aristocracy and the upper-middle classes in eighteenth- and nineteenth-century Europe” and relevant to contemporary habits of consumption [2, p. 88]. As Harrington explains, “...ideas of aesthetic sensibility have their roots in codes of social behaviour in eighteenth-century civil society. To understand these roots, we need to consider the significance of an emergent culture of leisure, tourism, connoisseurship and gentility”, recognizing that if gentlemen “were to distinguish themselves from the ‘vulgar’ and from those of recently acquired wealth, they had to show no care for the utility

of their possessions, they had to flaunt a life of disinterested display” [2, p. 89]. Such discourses of sensibility are tied up with the fashion for collecting, the contemplation of decorative objects, Grand Tour travel, and the culture of connoisseurship among “the members of the burgeoning commercial classes, anxious to naturalize their wealth in land and art” and demonstrate and affirm their “refinement, gentility, polish and distinction” [2, p. 90]. Such an established man can be considered the perfect “aristocratic hero” [30, p. 473], one who, like Sibire, participates in and appreciates the new aesthetic experience of the Fine Arts.

3. The Aesthetic Legacy of Chelonomy

In the context of France’s changing artistic and socio-political context, the cult of Stradivari was born and adopted, and became the measure against which all new violins were judged, a sort of “imaginary museum” [11] or “ideal museum” [8]. Sibire’s designation of violin-making as an art, its basis on imitative practices of an ideal model, and the transcendence of its natural and universal canon have persisted, if independently from the forgotten historical circumstances, meanings and ideological foundations. The old instruments proved not only to work in their new context, but gained an exaggerated quality of improving over time so that old violins seemed in a way indestructible. The ability of restorers to effectively renew old violins further enhanced the reputation of the old makers. Old Cremonese violins continue to be deemed classic and used in a modern context, and new instruments fail to compete with the old instruments, at least in their art-market value.

Sibire’s prescription for creative imitation, however, was arguably superseded during succeeding decades by exact imitation, as exact imitations of the Cremonese master instruments were lauded in competitions [18, pp. 371–422]; and by mid-century, while other musical instrument-makers realized innovative progress, lutherie as a whole in comparison was criticized by French and English critics for its servile copying, being in a way retrograde in its progress [18, p. 1]. Yet indeed, *La Chélonomie* fuelled the emergence in Paris of what would later be called “artistic lutherie” (*Lutherie artistique* and *Lutherie d’art*) in the making of new instruments as well as the restoration of old, canonic ones. Further, Sibire’s publication was the basis for the subsequent histories, including the first monograph on Stradivari, that built and elaborated on Sibire’s constructions of the artistic canon and idealized heroic makers [23, 31, 32].

Today, the transcendent violin-making canon, the foundation of a cult of the violin, endures to such a degree that the narrative is still somehow a product of our own time. This French tradition is so in-

grained in our views, that today we can casually discuss how English copies of old Italian violins look French, and heatedly argue about whether Stradivari's "*Le Messie*" (The Messiah) violin is a forgery by Jean-Baptiste Vuillaume.

4. Conclusion

On their own, violins are not universal, timeless, or transcendent, and their beauty is not inherent in their materiality (i.e. physical constitution), but in the mind of the beholder. Any degree of their value, transcendent or marginalized, has deep roots in their sociological and philosophical context, including the aesthetic landscape. The roots of Sibire's Chelonomy lay in the disunity of the sciences and arts, the division of craft-arts from the newly established Fine Arts, with its historicist classical foundations and the Ideal of the genius artist, and the ideologies of early-Romantic aesthetic autonomy and Sensibility.

Sibire's constructed canonic tradition is both distinctly historical and self-conscious [33, p. 13]. Sibire considers the violin as an object of aesthetic contemplation (outside of its musical function), thus justifying its place in the realm of autonomous works [12, p. 4]. This elevation of the "work" is not isolated to violin-making. Following the other arts, violin-making is in tandem with Fine Arts trends: the emergence of aesthetics, the definition of "works", the canon of great works and singular artists and the possibility to be identified as a form of Art. By examining this formational discursive and aesthetic context and its relationship with violin-making, we can further understand the current legitimacy of canonic violins.

We can understand that Sibire, in disagreeing with Horace's premise, aims to heal the divide between the Sciences and Arts, to unify violin-making practice in a way that is beneficial for makers, artistically, socially and economically. Sibire expresses aesthetic ideologies that are bound up in Bourgeois privilege, legitimizing violin-making to promote the value of violins (as art objects and as luxury goods), and the status of the maker, whose position was precarious in the 1806 open market.

Sibire's treatise promotes social stability (at least for the Bourgeoisie) and artistic, intellectual (and political) unity. Sibire seeks to unify and reconcile the sensual and rational in the aesthetically cultivated soul, though he seemingly contradicts himself by purporting universalism, while his views are elite and hierarchical, and by exhibiting new ideas and traits of early Romanticism, while his views are clothed in traditional classicism. Sibire simultaneously represents a conservative and progressive stance, whose compromise is comparable to *Juste milieu* ("middle way"), a term that was used from the eighteenth century to describe artists and architects who held stylistic or political beliefs

that stood between the progressive and conservative. *Juste milieu* can be seen in terms of the stylistic, balanced restraint of classicism, yet it definitely had socio-political elements. Such a compromise (positive or negative) had the potential for social unity and peace (which had not been achieved in France in 1806), and the potential for Sibire to capture readers standing in opposing intellectual corners. His work is both a diatribe and vision; it simultaneously embodies ideas and practices that are conservative *and* modern, historicist *and* innovative—all to promote the establishment of a new "classic" tradition for violin-making.

Sibire's classic method is not simply about style or form (plain, [1, p. 93], simple and symmetrical [1, p. 38]) or simply a violin-making method, it is thoroughly ideological and moral. His text is comprised of cultural-historical constructions, tastes and values relevant to his particular worldview, not only his place and time, but also his social standing and related circumstances and privileges, particularly Bourgeois privilege and the culture of collecting and connoisseurship. Sibire's reception of Stradivari only became possible with the development of the aesthetic theory of Art. Further, the value of his canon and transcendent violins has been upheld and sustained by the principle of aesthetic autonomy of art (and subsequently autonomous art).

In light of the circumstances in which the modern canon and discourse were founded, beyond a needed critical approach to aesthetic autonomy and the idea of universal, transcendent art, we need to be wary of Sibire's aesthetic judgments and prescriptions for canonic transcendence. We cannot simply ask "what" he says, we must also ask "why", acknowledging the historical circumstances under which inexplicable greatness is constructed and valued. This critical step is the link not only to a contextual reading, but reveals the processes of discursive formations that govern historical values and practices, and which have shaped our views today.

These findings have relevance to museum restoration, collecting, interpretation and exhibition. Arguably, many museums continue to promote the aesthetic autonomy of "high-art", glorifying the status of already privileged objects, despite best-practice trends that favour democratization and contextualization. Instead many institutions continue to rely on value that stands "beyond reason", problematically based on a timeless and transcendent aesthetic theory of art. From this perspective, it is necessary to go beyond how something or someone has achieved canonical status, and consider what conditions and means undo this process. That undoing—the challenge for a new understanding of violin-making's beliefs, values and practices, particularly including those held and promoted in the museum world—will require acknowledging and critically approaching our relationship with the past, and acknowledging what outdated and potentially irrelevant past aesthetic

ideologies and values have persisted into the present. This undoing is particularly critical given two recent shifts: 1) the institutional crisis of relevance and authority that arose in the twentieth century due, in part, to the adherence to an autonomous aesthetic theory of art [34, 35]; and 2) the somewhat concurrent end of the aesthetic regime that some have called the end or death of art [8, 12, 36].

ACKNOWLEDGEMENTS: This research was funded by the Academy of Finland, Research Council for Culture and Society for the project (no. 286367) entitled “The Beautiful Past: Rethinking Stradivari Violins in the Aesthetics of European Neoclassicism (c.1760–1814)” / “Kaunis Menneisyyden: Uudelleenarviointia Stradivarin Viulut Estetiikassa Euroopan Uusklassismiin (c.1760–1814)”, undertaken at the University of the Arts Helsinki, Sibelius Academy.

Fig.1

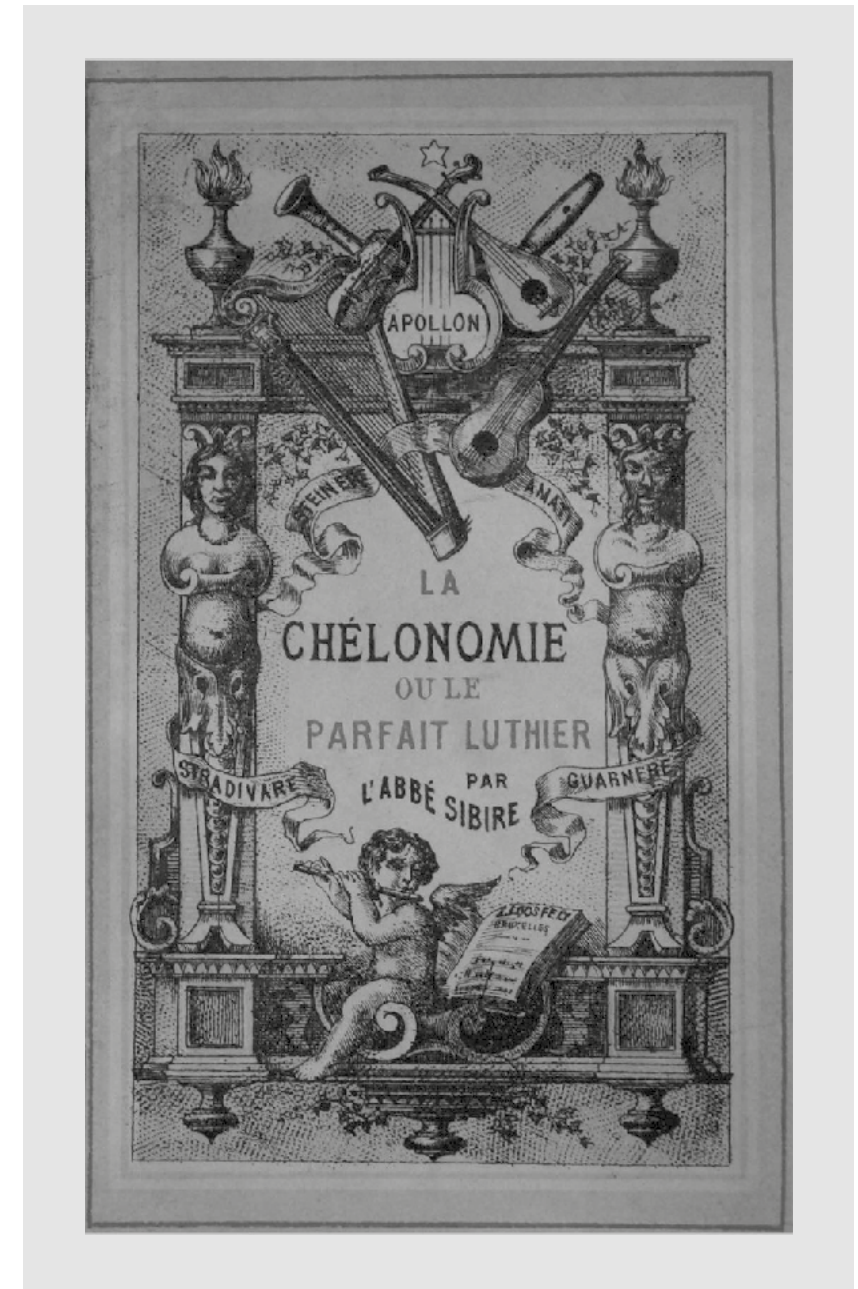

Fig.1 Sibire constructs the antiquity of violin-making, highlighted in the invented terminology of his title *La Chélonomie*, referring to the study or art of the ancient lyre made of a turtle-shell (derived etymologically from the Greek *chelón* (turtle or turtle-shell)). This 1886 edition continues the tradition with its monumental cover, glorifying the canonic makers *à l'antique*.

References

- [1] S.-A. Sibire and N. Lupot, *La Chélonomie, ou, le parfait luthier*. Paris: author, 1806.
- [2] A. Harrington, "Art and Social Theory: Sociological Arguments," in *Aesthetics*. Cambridge: Polity, 2004.
- [3] M. Everist, "Reception theories, canonic discourses, and musical value" in N. Cook and M. Everist, *Rethinking Music*. Oxford: Oxford University Press, 1999, pp. 378–402.
- [4] J. Samson, "Canon (iii)," in *Grove Music Online*. doi:10.1093/gmo/9781561592630.article.40598 Accessed on March 30, 2018.
- [5] V. Kurkela and M. Mantere, Eds. "Introduction," in *Critical Music Historiography: Probing Canons, Ideologies and Institutions*. Farnham, UK: Ashgate, 2015.
- [6] P. Lamarque, "The aesthetic and the universal," *Journal of Aesthetic Education*, vol. 33, no. 2, pp. 1–17, 1999.
- [7] K. Gloag, "A thing of the past: Canon formation and the postmodern condition," in V. Kurkela and M. Mantere, Eds., *Critical Music Historiography: Probing Canons, Ideologies and Institutions*. Farnham: Ashgate, 2015, pp. 227–237.
- [8] W. Cahn, *Masterpieces: Chapters in the History of an Idea*. Princeton, NJ: Princeton University Press, 1979.
- [9] C. Linsenmeyer, "Visions and trends of private and public collections: Confronting changing values," in D. von Roth and L. Escherich, Eds. *Proc. Private Passion – Public Challenge. Collecting Musical Instruments Then and Now*, Germanisches Nationalmuseum Nuremberg. Heidelberg: arthistoricum, 2017.
- [10] T. Eagleton, "The ideology the aesthetic," *Poetics Today*, vol. 9, no. 2, pp. 327–338, 1988.
- [11] C. Dahlhaus, *Foundations of Music History*, trans. J. B. Robinson, Cambridge, MA: Cambridge University Press, 1967/1983.
- [12] L. Shiner, *The Invention of Art: A Cultural History*. Chicago, IL: University of Chicago Press, 2003.
- [13] J. Rancière, *The Politics of Aesthetics: The Distribution of the Sensible*, trans. G. Rockhill. London: Continuum, 2004.
- [14] A. O. Aldridge, "Ancients and moderns in the eighteenth century," in *Dictionary of the History of Ideas*. [Online]. Available: <http://xtf.lib.virginia.edu> Accessed by: June 20, 2017.
- [15] D. L. Patey, "The eighteenth century invents the canon," in *Modern Language Studies*, vol. 18, no. 1, pp. 17–37, 1998.
- [16] P. O. Kristeller, "The modern system of the arts" (1951), reprinted in P. O. Kristeller, *Renaissance Thought and the Arts*. New York: Harper & Row, 1965, pp. 163–227.
- [17] S.-O. Wallenstein, "Space, time, and the arts: rewriting the Laocoon," *Journal of Aesthetics & Culture*, vol. 2, no. 1, 2010. doi:10.3402/jac.v2i0.2155 Accessed on: April 12, 2018.
- [18] C. Linsenmeyer, "Competing with Cremona: Violin-making innovation and tradition in Paris (1802–1851)" Ph.D. dissertation, Washington University, St. Louis, MO, 2011.
- [19] A. Choron and F. Fayolle, *Dictionnaire historique des musiciens, artistes et amateurs, morts ou vivants*, 2 vol. Paris: Valade, 1810–1811.
- [20] I. Kant, *Kritik der Urteilskraft* [*Critique du jugement; Critique of judgment*], vol. 3. Berlin: Lagarde und Friederich, 1790.
- [21] M. Greenhalgh, *The Classical Tradition in Art*. London: Duckworth, 1978.
- [22] S. Sontag, *On Photography*. New York, NY: Picador, 1977.
- [23] J. Gallay, *Les Luthiers Italiens aux XVII et XVIII siècles: Nouvelle édition du "Parfait Luthier" de l'abbé Sibire suivie de notes sur les maîtres des diverses écoles*. Paris: Académie des Bibliophiles, 1869.
- [24] W. Weber, 1999/2010. "The history of the musical canon," in N. Cook & M. Everist, Eds., *Rethinking Music*. Oxford: Oxford University Press, 1999, pp. 336–355.
- [25] J. J. Winckelmann, *Gedanken über die Nachahmung der griechischen Werke in der Malerey und Bildhauerkunst*, 2nd ed. Dresden: Waltherischen Handlung, 1755–1756.
- [26] J. Swafford, *Beethoven: Anguish and Triumph*. Boston, MA: Houghton Mifflin Harcourt, 2014.
- [27] J.-B. Dubos (l'Abbé), *Réflexions critiques sur la poésie et sur la peinture. Ut Pictura Poesis. Hor. De Art*, 2 vol. Paris: Jean Mariette, 1719.
- [28] C. Vout, *Classical Art: A Life History from Antiquity to the Present*. Princeton, NJ: Princeton University Press, (in press).
- [29] C. Haskins, "Kant and the autonomy of art," *Journal of Aesthetics & Art Criticism*, vol. 47, no. 1, pp. 43–54, 1989.
- [30] A. Grafton, G. Most and S. Settis, *The Classical Tradition*. Cambridge, MA: Belknap Press of Harvard University, 2010.
- [31] F.-J. Fétis, "Antoine Stradivari. Recherches sur les instruments à archet," *Le Ménestrel – Musique et Theatres*, vol. 23, no. 50, p. 3, cols. 1–3, Nov. 9, 1856.
- [32] F.-J. Fétis [with J.-B. Vuillaume], *Notice of Anthony Stradivari...*, trans. J. Bishop. London: Robert Cocks and Co., 1864.
- [33] W. Weber, "The eighteenth-century origins of the musical canon," *J. Royal Musical Assoc.*, vol. 114, no. 1, pp. 6–17, 1989.
- [34] S. E. Weil, *Making Museums Matter*. Washington, D.C.: Smithsonian Institution Press, 2002.
- [35] C. Linsenmeyer, "Liberté, égalité, and lutherie: Fetishizing Stradivarius in the context of French nationalism," in: E. Kelly, M. Mantere and D. B. Scott, Eds., *Confronting the National in the Musical Past*. London: Routledge, 2018.
- [36] A. Danto, *After the End of Art: Contemporary Art and the Pale of History*, Princeton, NJ: Princeton University Press, 1997.
- [37] G. Hegel and M. Inwood, Eds. *Introductory Lectures on Aesthetics*, trans. B. Bosanquet. London: Penguin, 2004, p. 84.

The Acoustics and Historic Development of String Instruments

GEORGE STOPPANI (1), COLIN GOUGH (2)

(1) Manchester, UK

(2) Physics and Astronomy, University of Birmingham, UK

Abstract

Plucked and bowed string instruments have existed for many hundreds, even thousands, of years. However, most of our knowledge about the sounds of instruments from before around 1500 relies on the iconography provided by sculptures and paintings. Our understanding of the acoustics of the violin and related instruments such as the viola, cello and double bass has advanced significantly over the last twenty years or so, largely through the use of digital technology. This project attempts to build on this progress, and more recent insights, to understand the historic development of stringed instruments from an acoustic perspective. This has involved measuring the acoustical properties of a number of modern reconstructions of older instruments, such as the lira da braccio and vihuela. Their properties are compared with those of the modern violin family. This is an ongoing investigation, with preliminary results described in this chapter.

1. Introduction

Around one hundred instruments, both newly built and valuable old Italian violins have been examined by experimental modal analysis. They have been measured fully setup for playing, at various making or assembly stages, and as separate parts examined in isolation. In addition, we now have detailed measurements of the sound radiation spectra for well over a hundred classic Italian instruments including violins by Stradivari, Guarneri del Gesu and members of the Amati family. Data is collected and shared in a community of makers and researchers.

Over the last dozen years or so, the present authors have independently and in collaboration played an active role in advancing our understanding of the vibrations of the violin and related instruments (Gough [1-4], Stoppani [5-7]). One of us (Stoppani) is a violin-maker, who has developed powerful data acquisition and analysis software for makers to use in their workshops [8]. This is now widely used by both makers and researchers to measure, record and analyse the vibrational and acoustical properties of interesting instruments wherever they can be investigated. The modal analysis measurements illustrated have been made with Stoppani software using a *roving* impact hammer (PCB MODEL 086E80) and fixed accelerometer (Dytran 3225F SERIES). (In their research the authors have also made use of 3-dimensional analysis with triple Polytec Doppler lasers.) The other (Gough) is a physicist / acoustician / violinist, who has used COMSOL computational finite element analysis (FEA) to model and thereby understand the vibrations and radiated sound of instruments investigated by Stoppani and others. This integrates the quest to understand how the physical and acoustic properties of both modern and historic instruments are important for the perceived sound and the playability of an instrument.

As part of the present investigation, preliminary measurements and computations have been made on a number of original and copied historic instruments, including the viola da gamba, lira da braccio and vihuela, and compared with those of the violin family. The modelling of such instruments, starting from a simple rectangular box to those of the violin's shallow, thin-walled, narrow-waisted, box-like, shell structure, with orthotropic materials, arched top and back plates supported by thin ribs, closely mirrors the historic development of both bowed and plucked stringed instruments in many cultures.

2. Violin Acoustics

[Fig.1] shows an overlay of five Stradivari violins measured by the American violin-maker Joseph Curtin. All high-quality violins, classic Italian and modern, have very similar spectra. The frequency range below 1 kHz is referred to as the signature mode region with sound

radiated almost uniformly in all directions [9]. There are three dominant acoustical resonances: the Helmholtz *A0* resonance associated with air bouncing in and out of the *f*-holes, which is driven by the *B1*- and *B1+* modes. The latter modes are formed from a coupled combination of the volume-changing, strongly radiating, *breathing* mode of the violin and an otherwise only very weakly radiating *bending* mode of the body shell. In addition there are often weaker contributions from what are known as *CBR* and *C4* modes. Above 1 kHz the acoustic wavelength becomes comparable with the size of the instrument and the radiation becomes increasingly directional, though the directionality is quickly averaged out in a confined performance space. There is then a cluster of relatively strongly radiating resonances around 1 kHz known as the *transition* region and a broader cluster from around 2-3 kHz, originally referred to as the *BH* Bridge Hill feature, but now recognised to involve the properties of the island area between the *f*-holes as well [4].

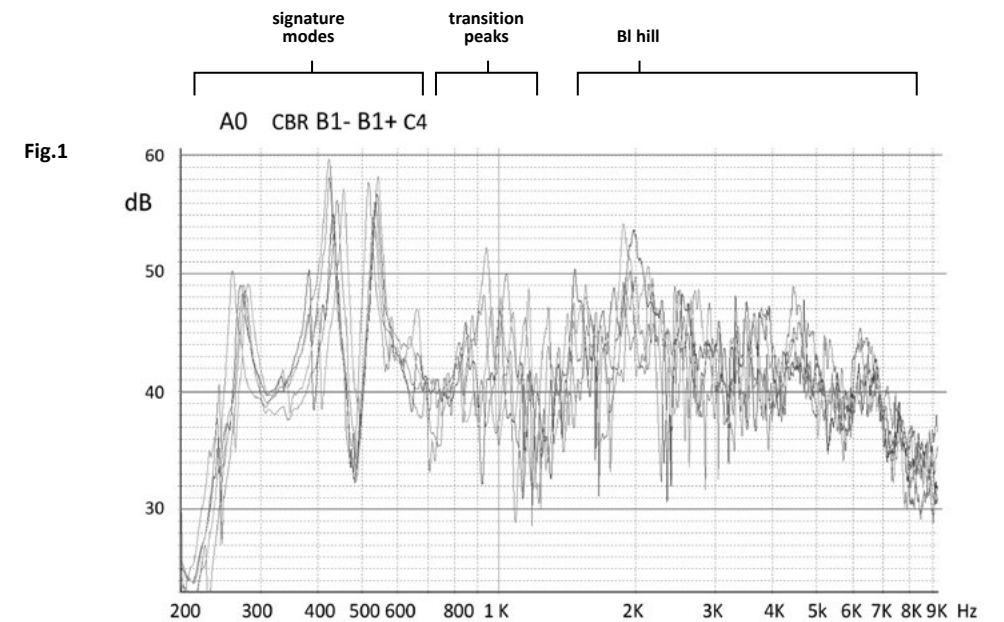

Fig.1

Until quite recently, very little was known about the acoustic properties of classic instruments that were considered to be of high quality, or what factors informed such judgements [8, 10]. Knowledge gained through measurement then served as a blueprint for modern makers wishing to make instruments of comparable quality. More recently it

Fig.1

An overlay of the radiated sound from five Golden Period or later Stradivari violins (data courtesy of Joseph Curtin).

has been recognised that fine new instruments can match the acoustic qualities of the old Italian masters. The emphasis has therefore moved towards musicians' and listeners' preferences, regardless of whether they are old or new [7, 11].

Measuring mode shapes and frequencies and using FEA to discover how they depend on the makers choice of materials, graduations of plate thicknesses and arching, plus the role of the strings, bridge, bass bar and soundpost, have provided valuable insights and understanding for makers. This potentially aids them in the making and setup, allowing them to consistently make instruments of the highest quality, as illustrated in **[Fig.1]** by the large degree of correlation between the acoustic properties of five high-quality Stradivari instruments. However, we are still learning, and until fairly recently the nature of the prominent low-frequency resonances, let alone the higher-frequency modes, were not well understood; nor was the influence of the bridge and island area between the f -holes, nor in any detail, the role of the bass bar and soundpost. All such components influence a frequency-dependent input filter between an instrument's vibrating strings and radiating surfaces [4], which determines the perceived timbre and spectral balance over the whole playing range. This topic may well become an important focus in shaping the response and voice of all bowed string instruments.

To gain the necessary understanding of the modes of the violin and related instruments, FEA modelling has been used as a quasi-experimental tool. This has involved changing physical parameters such as plate arching heights, rib strengths and coupling to internal air cavity resonances, often over many orders of magnitude, thereby enhancing our understanding of the important modes of the violin. Such understanding also provides valuable insights into the likely vibrational and acoustical properties of historic instruments, as illustrated later. In addition, FEA analysis has enabled us to understand the rather complicated relationship between the individual free plate modes of vibration and those of the plates in the fully-assembled instrument [2]. To the present authors' knowledge, this is the only paper describing how the signature modes of the violin are related to the free plate modes other than by means of a heuristic model. Matters relating to accuracy are not directly relevant since the paper makes it quite clear the intention was to provide understanding rather than accuracy. Nevertheless, the predicted signature mode shapes and mode frequencies are in excellent agreement with observed mode shapes and frequencies, which typically differ by around 10% (less than a tone) from one fine instrument to the next. Despite the complicated transition from free plates to assembled corpus, the individual plates remain the main source of radiated sound in all stringed instruments, as the strings themselves radiated a negligible amount of sound. Free plates, despite the radically dif-

ferent boundary conditions once the box is assembled, continue to be important for makers, largely because it is so much easier to optimise their properties before rather than after assembly. To a first approximation, the modes of the plates on the fully-assembled instruments will be determined by the same elastic parameters and densities of the plates when freely mounted.

3. From Free Plates to Body Shell

In an earlier paper [2], FEA computations were used to investigate the influence of geometric shape, plate thickness and graduation scheme, the arching heights and profiles, and the anisotropic along-and cross-grain orthotropic properties of spruce and maple. It was shown that the modes of freely supported rectangular plates could be smoothly morphed into those of the guitar-shaped plates of the violin. Although changes in geometry result in significant changes in mode shapes and frequencies, the number of modes below a given frequency remains almost unchanged. This follows from the 2-dimensionality of the mode shapes and the relationship between frequency f and wavelength λ of flexural waves on thin flat plates of thickness t , $f\lambda \propto c_L(t/\lambda)$ where c_L is the speed of longitudinal waves in the solid. Unlike normal sound waves, the speed of the flexural waves, responsible for radiating sound, is not constant, but is proportional to the ratio of plate thickness to wavelength. Whereas early string instruments tended to use flat plates, later instruments increasingly used more rigid arched plates to support the downward pressure of the strings stretched over the supporting bridge. Higher stiffness could be achieved with lower mass, making it more acoustically and structurally efficient. The important low-frequency body shell modes were then increasingly dominated by the arching height rather than plate thickness [2].

Wood such as spruce, typically used for soundboards, has exceptionally large anisotropy of the along and cross-grain Young's moduli, often as large as 20. Perhaps surprisingly, anisotropy has only a weak influence on the low-frequency, signature modes (e.g., where the bending wavelengths are commensurate with or larger than the plate dimensions) for a given geometric mean of the orthogonal moduli. This is largely because the wave shapes are 2-dimensional and must therefore always involve an average of the along and cross-grain elastic constants [12]. However, recent investigations [4] have shown that, at higher frequencies, the properties of smaller, localised regions, like the island area between the f -holes, C-holes or slots, are dominated by the weaker cross-grain Young's modulus.

[Fig.2] traces the transformation of the modes of the freely supported top and back plates, with the first few modes tuned to rather

similar frequencies, as the rib strength supporting their edges is varied from around a millionth (effectively freely supported) to a more typical normal value [3]. This is easily achieved on a computer, but clearly impossible in practice! Nevertheless, such large changes provide very valuable information on how the ribs influence the frequencies and mode shapes of real instruments.

Fig.2

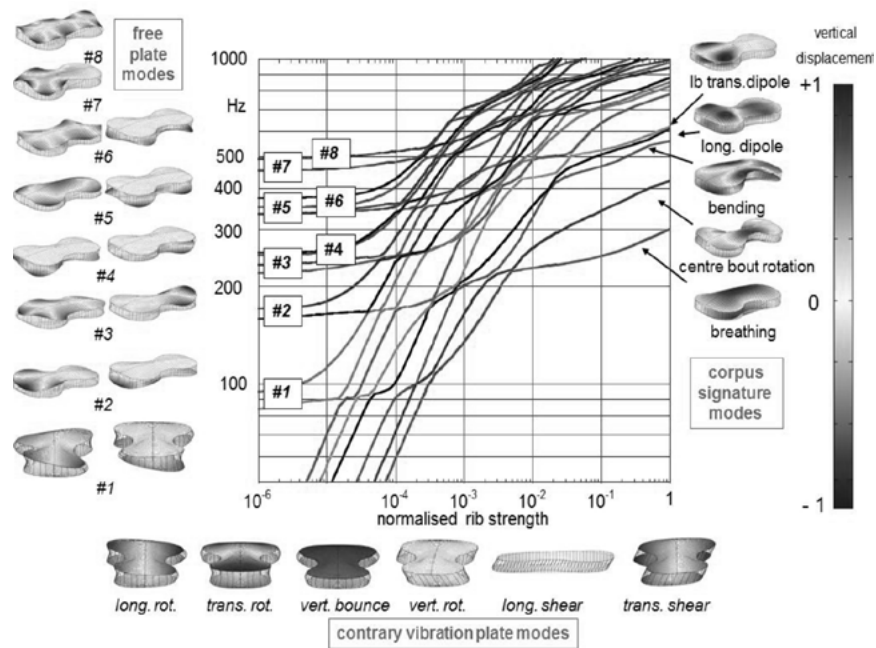

[Fig.2] also shows many of the generic features common to all shallow, box-like instruments, such as the vihuela and lira da braccio, as well as other members of the violin family. Firstly, almost all low-frequency, initially freely supported, top and back plate modes, grouped on the left-hand side, are dominated by what we might call *flexural wave edge states*, which are unique features of flexural waves [2]. Such modes decay rather quickly towards the inside area of the plate, other than mode #5 (*ring mode*), which has a large amplitude at the centre of the plate. The freely supported top and back plates were tuned to within a semitone or so of each other, by choosing appropriate physical properties on performing FEA computations. The plates of old Cremonese instruments are usually quite closely matched. It therefore seems very likely that a method for tuning was employed, presumably by tapping and listening. However, there is no contemporary written

Fig.2

The influence on the modes of the rib-coupled plates, as the rib coupling strength around the plate edges is increased from 10^{-6} to a typical normal value.

evidence, nor is enough known about earlier types of instruments to make any useful speculation.

4. Body Shell, Bridge and Island

Despite the very strong and complicated influence of the rib coupling on the coupled plate modes, for ribs of normal strength, there are only a small number of relatively simple low-frequency modes of the body shell, as illustrated in Fig.3. Similar modes are to be expected for all instruments of the violin family, though not necessarily in the same frequency order. Such ordering depends critically on their individual geometry, plate thicknesses, arching and wood properties, but the individual mode shapes and frequencies transform smoothly as these parameters are varied.

Of this set of generic modes, the volume-changing, “breathing” mode is acoustically the most important. For members of the violin family, this mode is responsible for almost all the radiated sound over the first 2-octaves of the instrument, either directly or by its coupling to otherwise only weakly radiating modes [3, 9]. The one exception is its coupling to the Helmholtz cavity air mode with air bouncing in and out of the *f*-holes. This important mode is present in all historic and modern instruments with open hole or holes cut into their body shell. For members of the violin family, the vibrations of air through the *f*-holes strongly supports the sound radiated at low frequencies below the *breathing* mode resonance, which would otherwise radiate very weakly at lower frequencies. One of the interesting aspects of our present research on older historic instruments is to investigate how the rose-holes or slots cut into their top plates perform a similar function.

In addition to the formation of the A0 mode, the coupling of the breathing mode to the Helmholtz *f*-hole resonance also significantly increases the frequency of the breathing mode. As a result, for the violin, its frequency approaches that of an anticlastic bending mode of the body shell (bending with opposite signs along the length and across the width). For a pair of arched plates with different material properties and arching profiles, this results in a strong coupling leading to a pair of independent, non-interacting, normal modes: *B1-* and *B1+*, illustrated by prominent resonances in Fig.1, with the breathing and bending mode components of the two normal modes vibrating either in the same or opposite phase relationship.

The initial *breathing* mode, responsible for almost all sound radiation in this frequency region, is now shared between these two modes by amounts determined by the relative frequencies of the two coupled *component* modes and the strength of their coupling [3]. Because the coupling depends on the arching, it is unlikely that it occurred in instruments

Fig.3

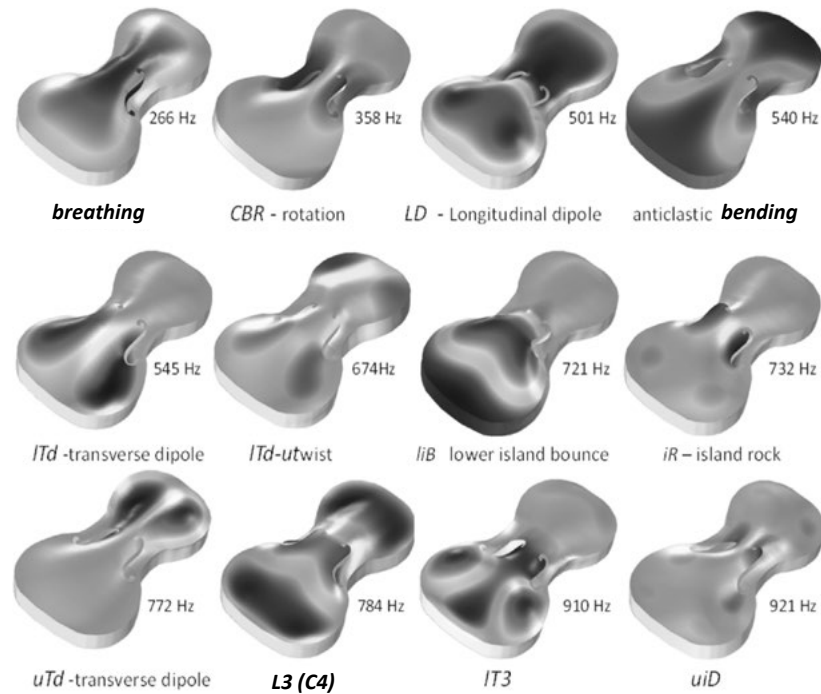

with flat plates, though types of corpus bending might well couple to other plate modes. High ribs, as in cellos, double basses and members of the viol family, raise the frequencies of the *bending* and *CBR* modes. Instruments such as the viola da gamba, with an arched top but flat back plate, have only a single, strongly radiating, *B1*- resonance. Cellos can have a *B1+* mode but it usually has small amplitude and a small breathing component; the *CBR* mode is often strongly coupled to the *B1*-breathing.

Most early instruments had a symmetric body shell structure with its vibrational modes therefore either symmetric (e.g., the *breathing* mode) or antisymmetric (the *CBR* and transverse dipole) modes, as illustrated in **Fig.3**. Bowing the strings in a transverse direction on a centrally mounted bridge will cause the bridge to rock side to side on its two feet, exciting only the antisymmetric modes, which only radiate weakly at low frequencies. Deliberately introducing some internal asymmetry into the design of stringed instruments was therefore a major development, as the asymmetric rocking of the bridge could then excite the strongly radiating *B1*-breathing and induced *A0* modes [6]. This enhances the warmth and richness of the sound of the

Fig.3 The first 12 computed modes of an empty violin body shell illustrating on a greatly exaggerated scale the vibrations of an empty violin body shell (no neck, bridge, bass bar or soundpost), with a possible nomenclature to describe the symmetry of the modes.

violin family instruments over their lowest two octaves. The asymmetry may have been achieved in early instruments by asymmetric graduation of the top plate, but later by the introduction of the offset bass bar and, most importantly, the soundpost [13]. The first literary reference to a soundpost (indeed, the first of any evidence) is *James Soundpost*, a comic musician in Shakespeare's *Romeo and Juliet*, written around 1591. This suggests that soundposts were novel in England at that time, but were presumably introduced somewhat earlier. A reasonable assumption could be around 1550, when Andrea Amati was developing his violin family of instruments. There is no reason to assume that the soundpost was immediately adopted in all instruments that could potentially benefit from their presence; it is far more likely that older and newer technologies and traditions coexisted for some decades.

Another important feature in the design of stringed instruments was the elongated slots, open round holes, fretted rosettes and *f*-holes cut into the top plate. As indicated above, air bouncing in and out through these holes results in a strongly radiating *A0* mode, which strongly boosts the sound at low frequencies. For bowed rather than plucked string instruments, the slots, C- holes and *f*-holes also create a highly flexible *island* area between their edges. In older instruments, the bridge, supporting the strings, tended to be placed either just above or below the island area, often with strengthening bars underneath the top plate, as in the *lira da braccio* illustrated later. In modern violins, the standard position is close to the centre of the island area, opposite the notches, midway along the *f*-holes, whereas for early violins and closely related instruments, the bridge was often mounted below the island area. The most commonly offered explanation for this practice is that the vibrating string length was increased to facilitate playing at a lower pitch.

For members of the violin family, tall bridges with curved tops optimise the intensity of sound that can be radiated, especially when mounted on the flexible island area with both a bass bar and an offset soundpost wedged between the top and back plates. However, the coupling between the bowed strings and vibrational modes of the bowed strings and the individual body shell vibrations must not be too strong, otherwise it results in the infamous *wolf-note*, producing a croaking or warbling sound, when it becomes impossible to bow a steady note [5]. Optimising the coupling between the vibrating string and the body of an instrument is one of the many skills an expert violin-maker employs to influence both the sound quality and playability of an instrument. This is achieved, by choosing an appropriately cut bridge, an appropriate arching and thickness for the top and back plates, especially in the island area, height and profile of the bass bar, soundpost position and choice of strings. All such adjustments affect the loudness, the playing feel and the timbre.

From an acoustical point of view, the position of the bridge is clearly a major factor in determining the coupling between the vibrating strings and the radiating surfaces of the body shell. Mounting at the centre of the island will clearly set up the strongest vibrations originating in this area and coupling with the radiating modes of the upper and lower bouts. This position also allows the strongest possible bowing of the outer two strings resting on a curved bridge top, without the bow hair hitting the inner waist edges. The waist ultimately became very useful in this respect, but before the mid-1500s, bridge placement does not seem to have been much influenced by the outline. In the more intimate performance spaces of earlier times, when radiated sound power was less important, moving the bridge to different positions below and inside the length of the island could have provided not only a way of adjusting the length of the strings for different pitches, but also the quality of sound produced by the instrument. Furthermore, if there were no soundpost, placing the bridge outside the island would both reduce the *wolf* problem and avoid the sinking of the island under the force at the bridge feet.

The bridge plays a very important acoustical function in all stringed instruments, ancient and modern. For plucked instruments with the bridge glued to a flat soundboard, the bridge had to be low (in height) or the torsion would have torn it away from the top plate, as is still true today. Many bowed instruments also had low bridges, but the iconography also shows some rather tall ones, particularly on liras da braccio. The much larger resolved downward force of the string tension would, if the bridge were placed at the middle of the island, result in a short life for the instrument, unless the plate was very thick. Placing it at one end of the island, probably with the addition of a transverse bar, would solve both a structural problem and help minimise the potential *wolf* problem. Plucking the strings at an angle to the top plate gives a strong attack to the plucked note from string vibrations perpendicular to the top plate, by coupling strongly with the radiating plate vibrations, and a long ringing sound from the only weakly coupled string vibrations parallel to the plates—just like the sound of a guitar, spinet, harpsichord or piano. Bowing an instrument with a low bridge and no island cannot excite either symmetric or antisymmetric modes effectively, so the sound will be very weak. Presumably, when this was done, there was no expectation of or perceived need for a powerful sound.

5. Historic Instruments

Iconography is of major interest to researchers of historic instruments because it can potentially corroborate other sources and, in some instances, may be the only source. It can also be misleading; there could be an element of invention on the part of the artist or simply inaccuracy due to

lack of knowledge of musical instruments. Artists sometimes copied earlier works, or conjured notions of traditionally idealised pastoral scenes or ancient Hellenic culture, all of which undermine the reliability of their work as historical evidence. For this reason it is unwise to build an argument on evidence based on sparsely represented instrument types. On the other hand, depictions of some instruments are so common that collectively they can be considered a robust source. For example, from the early 1600s violins and violas da gamba appear frequently and often in fine detail such that, in conjunction with written sources, it is possible to plausibly reconstruct the setup and stringing practice. A method for making historically convincing strings has now been in use for some decades and has wide acceptance among musicians. Research followed up by a physical reconstruction has been the main way that knowledge of historic instruments has progressed. The methodology presented by the authors offers an additional tool that may help to circumvent a lack of information or ambiguity in the more usual sources.

The Moorish occupation in Spain lasted for nearly 800 years. Spain also had a prosperous Jewish community, the largest in Europe, with many educated and skilled people. It was a very important region for cultural exchange and innovation and continued to be a magnet for musicians and artisans up to the financial decline of the Spanish Crown around 1600. Culture and musical instrument technology also spread by many other means, such as via military expeditions and travelling merchants. For example, the ancient Sutton Hoo lyre and Trossingen lyre appear to be very similar [Fig.4(a)]. They were court instruments with elaborate ornamentation. The lyre may have arrived in England with the Saxons, but similar instruments could also have been introduced by the Romans. Of particular interest, these instruments were made by carving the back, sides and arms from a single piece of wood. The beam between the ends of the arms is jointed and held the tuning pegs. The same approach was taken for making the lira da braccio, except the pair of arms was replaced by a neck and peg box (Fig.4(c) and Fig.4(d)) and it was bowed instead of plucked. Instruments like these liras are ubiquitous in the iconography from mediaeval times, but modern reconstructions are rare. The reason is probably that, although such instruments were common and culturally important, there is no surviving repertoire, and no one really knows how to play them.

There are examples of instruments that have an oval outline and a rounded back, perhaps carved or with bent staves like a lute (Fig.4(b) and Fig.5, left). These were possibly very like the early kind of oud shown in Spanish iconography. Sometimes they were also bowed. Another ancestral line from the early 1400s, perhaps originating in Spain, was instruments assembled with glue from pieces of wood planed and scraped to thickness, and with the ribs bent to shape. The carved-body liras had little or no

Fig.4

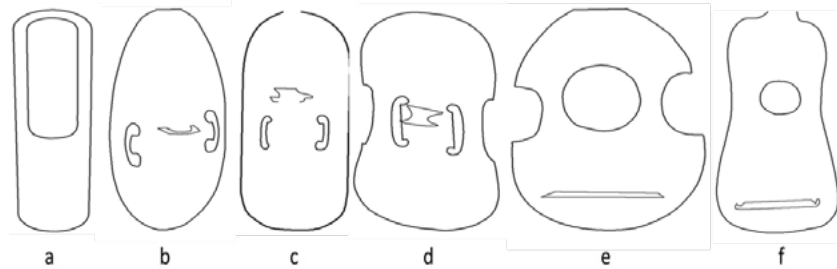

waist but those made with bent ribs often had deep C bouts and a fixed bridge (**Fig.4(e)** and **Fig.5**, centre), to which the strings were tied. Instead of a pair of holes as seen in the oval, oud-like, round-backed example (**Fig.5**, left), there was a round hole some distance from the bridge.

Before 1500 the plucked and bowed forms of the viola were diverging and developing features more advantageous for either plucking or bowing. The plucked type became dominated by the elongated guitar-like shape, with the bridge far down in the lower bout and a round rosette above the waist. By the mid-1500s, *vihuela* meant this type of instrument (**Fig.4(f)** and **Fig.6**, right).

Fig.5



In the bowed versions, a pair of slot-like holes was placed near to the bridge allowing for more rotation of the bridge, similar to liras, which had always had elongated holes and an island. Also merging with the carved lira tradition, the strings were attached, via a tailpiece, to the end of the corpus. This made possible a bridge that could be much taller and could be moved to different positions along the length of the instrument (**Fig.6**, left).

Fig.4

Outline shapes for early instruments (a) Sutton Hoo lyre reconstruction, (b) oval, round-backed lira, (c) from van Eyck altarpiece, 1436, (d) Giovanni Bellini, San Zaccaria altarpiece, 1505, (e) a vihuela with deep C bouts, (f) more typical vihuela from mid 1500s.

Fig.5

(left) From Cantigas de Santa Maria, thirteenth century; (centre) Spain, late 1400s; (right) Bartolommeo Montagna, Milan 1500.

Fig.6



The naming of instruments from this time is fraught with confusion. *Vihuela* is simply the Spanish word for viola and the two were, at first, interchangeable. *Vihuela* or *viola* denoted a category of instruments with flat, wooden plates, bent ribs and an elongated neck. A *viola da mano* was held like a guitar and plucked with fingers or a quill, whereas the *lira*, *viola da braccio* and *viols* were played with a bow and held in various ways. A *lira da braccio* might take the oval, carved or deep-waisted form. A *viola da braccio* differs only in not having the one or two un-fingered strings of the *lira* and usually only four strings. A *viola da gamba*, held on the knees or between the legs could also take a large variety of forms, few of which survived long into the sixteenth century. These names do not directly define the precise construction of these instruments, which probably concerned the musicians less than their particular musical usage. Rather similar-looking instruments might be employed for a variety of purposes, while some that were significantly different could be employed for the same purpose. In the iconography, we can see bridges with flat tops and different amounts of curvature. When flat, the playing style may have been like a hurdy-gurdy, all strings sounding at once, but with the possibility of fingering a melody on one or more outer strings. Liras with some bridge curvature and five to seven strings would suit an arpeggiated style, while *violas da braccio*, with only 4 strings could probably allow single, melodic notes.

Arched plates appear in the iconography from around 1500. The Bartolommeo Montagna picture from 1500 (**Fig.5**, right) shows a *lira da braccio* with an arched top. If it also had an arched back, which cannot be seen, it would have almost had the essential design features of a violin and the potential to benefit from an offset soundpost, though is unlikely that it had one. The ribs are carved, which we can infer from the way they are scalloped, so it is from the carved *lira* tradition, but with elements from the bent rib, *viola* tradition.

An overview of the sixteenth century suggests a trend towards greater depth in instrument sound. New types of bass strings became available which were more flexible and stretchy, making it practical to use higher tensions or lower pitches without increasing the vibrating length. It may have been plucked instruments, such as lutes and *vihuelas*, which first took advantage of this innovation since no major

Fig.6

Viola da braccio, Italian, 1544 (left) and *vihuela*, Luis de Milan frontispiece, 1535 (right).

design changes were needed. The direction taken with bowed instruments may well not have been driven by a desire for greater depth at all. Measurements demonstrate that the island area provided a means of getting more high-frequency energy into the corpus by exciting centrally antisymmetric modes (**Fig.7**, fourth from left). Antisymmetric modes, while poor low frequency radiators, radiate well at higher frequencies, where the radiated energy becomes highly directional, but proportional to the vibrational amplitudes of the body shell. The technology that allowed for massively improved low frequency response in bowed string instruments was coupling of centrally antisymmetric modes to symmetric *breathing*, or volume-change modes (as described in section 4). The asymmetry enforced by the offset bass bar and soundpost made this possible.

6. Measurements and Computations on Historic Instruments

In this section, we present preliminary measurements and computations made on a number of modern reconstructions of historic instruments. We were able to find examples that are, arguably, representative of the instrument types and features discussed above. We were interested in generic types so that we could apply FEA modelling and experimental modal analysis to explore generic behaviours, such as for corpora with flat plates but different outlines and soundboards with and without islands. This approach provides insight into the acoustic function and evolution of historic instrument at the same time as enhancing knowledge of violin acoustics. As this was a preliminary study it was decided to do the FEA modelling without attached neck for the sake of simplicity. Work with violins with and without necks shows that the inertia of the neck can lower the frequency of the bending mode and that neck / fingerboard modes can interact with corpus modes splitting them into a mirrored pair. The authors believe that it is good practice to try to understand a simpler state and add the effects of substructures at a later stage. The effects of the presence of a neck can be seen in the measured data.

6a. Viola da gamba

The authors have performed experimental modal analysis on two violas da gamba and have conducted a preliminary generic FEA investigation. We will briefly describe the measurements on just one of the instruments, made by Stoppani in the early 1980s using a model after the John Rose family from around 1600. It has a flat back with no cross-bars and an arched top made of five bent staves—a construction used by a number of English makers around that time. There is a small bass bar and a soundpost. The corpus length is 43.5 cm, like a large viola, but with twice the rib height at 8.8 cm. A flat back double bass has a very similar

construction with rather similar modal behaviour. As with the cello and double bass, the taller ribs significantly increase the frequency while reducing the amplitude of the corpus *bending* modes. In this gamba, there is no evidence for the usual *CBR* mode always seen in the violin and viola, though the generic corpus bending modes can still be found at much higher frequencies (relative to the breathing mode) but coupled with higher order plate modes. As with all arched plates, the rib edges adjoining the top plate can move inwards and outwards, as the out-of-plane flexural vibrations strongly induce in-plane longitudinal radial and peripheral stretching and compressions around the edges.

There are two regions of significant volume changes from the flexural vibrations, which will result in strong radiation. One is the *A0* mode at around 140 Hz and the other is a single *B1 breathing* mode at around 250 Hz. There is no *B1+* mode.

6b. Lira da braccio

This instrument on which measurements were made is a reconstruction based on many examples found in the iconography. It appears to have been made by a competent, though probably not professional, craftsman. Due to a variety of setup issues it was decided to perform the modal analysis without strings, with an equivalent driving point position close to where the left foot of the bridge would traditionally have been. It serves as an illustrative example of a given type of instrument, as described above and shown in **Fig.4(c)** and **Fig.4(d)**. Of particular interest is the very large island area in the top plate bounded by long slots with two transverse bars positioned under the soundboard (2 to 3 cm), one above and one below the island area.

Surprisingly, these bars have a relatively small influence on the low frequency mode shapes and frequencies—much less so than holes or outline features that determine the boundaries within which the flexural waves have to fit. Although the island area occupies a much larger proportion of the top plate than that of the violin, there is still a close similarity with several of the modes of the violin, illustrated in **Fig.3**.

Although the elastic properties of the measured lira da braccio were unknown and had to be guessed and that these preliminary FEA computations were made *in vacuo*, **Fig.7** illustrates relatively strong agreement between the computed and measured frequencies and shapes for some, but not all these first few modes. By modifying the parameters used in the FEA computations, a much closer comparison will almost certainly be achieved. In both experimental and FEA computations, many of the higher frequency modes are observed to be strongly localised in either the top or back plates. This is because the two plates will resonate with nearly identical modes shapes but at different frequencies. Only when their frequencies are

closely matched and the excited modes share common symmetry elements will the vibrations in both top and back plates be strongly excited together. As with the violin family, this tends to happen more easily at lower than higher frequencies, when the vibrational modes can also be primarily excited in either the upper or lower bouts of either the top or back plates.

Fig.7

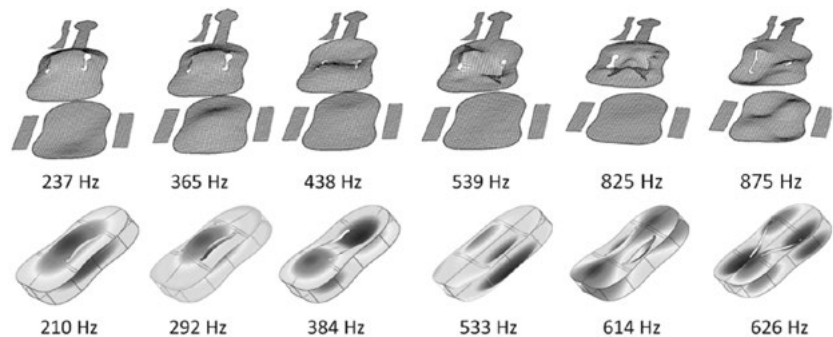

Interestingly, the measured *A0* *f*-hole resonance at 237 Hz has no obvious single *B1-breathing* mode with plates vibrating in opposite directions to drive it. In contrast to the violin, there is a relatively strong *anti-breathing* mode (both plates moving in the same direction) measured at 365 Hz and computed at 292 Hz. Because the top and back plates have significantly different thicknesses and other properties, this mode has a net volume change, which might be responsible for exciting the observed *A0* resonance. In addition to measuring mode shapes and frequencies, in both the experimental and computer modelled investigation, it is easy to compute the net volume change of the empty shell when driven from a given point. The rate of change of volume is directly related to the monopole radiation source responsible for radiating sound uniformly when the size of the instrument is less than the acoustic wavelength. This information can then be used to provide a realistic estimate of how the instrument would probably have sounded in the lower frequency range.

6c. Vihuela

Iconographic evidence reveals numerous instruments with shallow boxes and deep C bouts, like the vihuela, which was sometimes plucked and sometimes bowed (viola da mano and viola d'arco, in Italian). We have investigated the modes of a copy of such an instrument made by an able student in 1980. The depth and size of the C bouts is nearing

Fig.7

Comparison of experimental modal analysis measurements on a Lira da braccio with unknown elastic properties and FEA *in vacuo* computations using guessed elastic properties.

the extremity of what we observe in the iconography. There is a round hole at the middle of the waist with a parchment rosette.

As an example of the kind of modes that would be expected on an instrument of this shape, **Fig.8** shows the first eight modes computed for the *in vacuo* modes of a generic model of the vihuela. The model has the same geometry as the measured instrument, with anisotropic elastic constants chosen to give reasonably close matching of the freely supported plate frequencies.

These computations emphasise the difference between the modes of instruments having an island area, formed between slots, and instruments with an open hole between the waists. A major effect of the low rib height and deep C-bouts is to lower the frequencies of the corpus bending modes permitting coupling to the low order plate modes and to the rigid body and bending modes of the neck structure.

Fig.8

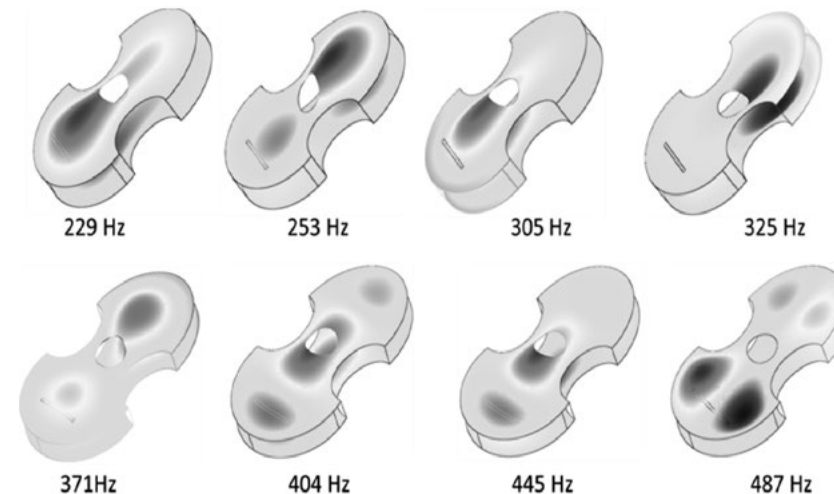

There are now two *breathing* and two *anti-breathing* modes with volume changes largely localised within the upper and lower bouts. Because of differences in top and back plate properties, all such modes will have a net volume change, which could excite the *A0* *f*-hole air resonance (not shown here because the computations at present are *in vacuo*).

In addition, there is a mode surrounding the round hole, which is closely similar to the *CA* mode of the violin, with both longitudinal dipole modes and transverse dipole modes in both the lower and upper bouts. The attached neck is likely to significantly affect the low-frequency modes localised in the upper bout.

Fig.8

The first *in vacuo* eight computed body shell modes of a generic vihuela model without attached neck and peg arm.

Fig.9 shows mode shapes measured for the lowest frequency modes of the vihuela. The agreement between the computed generic model predictions and measured modes is not as good as those of the lira da braccio. This is probably because these preliminary computations lacked the rather heavy neck and were performed *in vacuo*, which would have changed the frequencies of any volume-changing breathing mode, but not significantly the modes shapes. In addition, the measured vihuela had two strong strengthening bars above and below the open hole, which had not initially been discovered because access to the inside was limited by the parchment rosette covering the hole.

ACKNOWLEDGEMENTS: We are particularly grateful to Professor Jim Woodhouse for many helpful discussions and valuable feedback. This research is self-supported other than through the COST initiative.

Fig.9

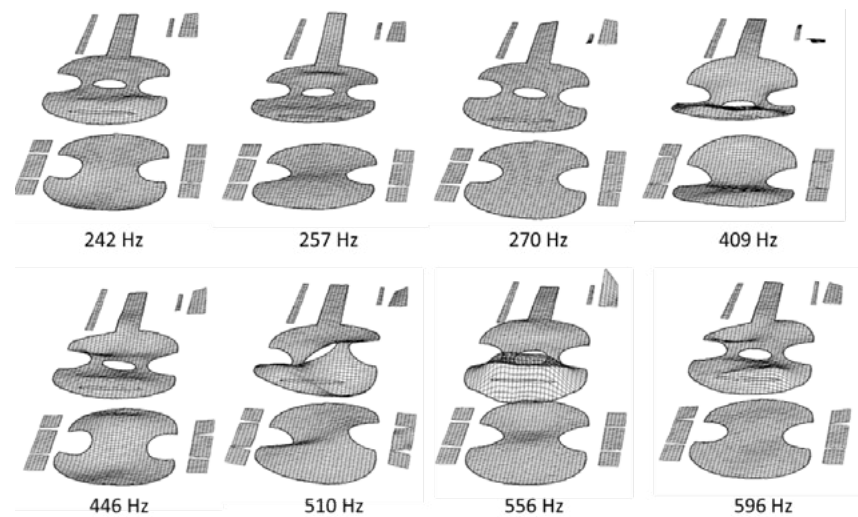

7. Conclusion

Significant progress has been made towards understanding the vibrational and acoustic properties of a number of different designs of historic instruments, through applying our increasingly detailed understanding of the violin family. While experimental modal analysis provides the means to fully characterise the acoustic and vibrational properties of historic instruments, computer aided finite element analysis offers valuable insights into the observed properties. Due to the rarity and fragility of surviving instruments, modal analysis is normally performed on modern copies and sometimes the only source of information is iconographic. The longer-term aim is to support people researching and building reconstructions in order to explore the possible sounds and playing characteristics of less well understood historic instruments.

Fig.9 The first eight measured modes of the vihuela.

References

- [1] C. E. Gough, “Violin acoustics: The acoustics of thin-walled shallow boxes – A tale of coupled oscillators,” *Physics Today*, vol. 12, no. 2, pp. 22-30, 2016.
- [2] C. E. Gough, “Violin plate modes,” *J. Acoust. Soc. Am.*, vol. 137, no. 1, pp. 139-153, 2015.
- [3] C. E. Gough, “A violin shell mode: Vibrational modes and acoustics,” *J. Acoust. Soc. Am.*, vol. 137, no. 3, pp. 1210-1225, 2015.
- [4] C. E. Gough, “The violin bridge-island input filter,” *J. Acoust. Soc. Am.*, vol. 143, no. 1, pp. 1-12, 2018.
- [5] A. Zhang, J. Woodhouse and G. Stoppani, “Motion of the cello bridge,” *J. Acoust. Soc. Am.*, vol. 140, no. 4, pp. 2636-2645, 2016.
- [6] G. Stoppani, “Modal analysis illuminates the history of the soundpost,” in *Proc. 3rd Annual COST FP1302: WoodMusICK*, Barcelona, 2016.
- [7] G. Stoppani, “Basque to the future,” *The Strad Magazine*, September 2017.
- [8] G. Stoppani, “Acoustic measurements in the workshop,” in *Proc. Stockholm Musical Acoustics Conf*, pp. 16-23, 2013.
- [9] G. Weinreich, “Directional tone colour,” *J. Acoust. Soc. Am.*, vol. 101, pp. 2338-2346, 1997.
- [10] J. Curtin, “Measuring violin sound radiation using an impact hammer,” *J. Violin. Soc. Am (VSA Papers)*, vol. 22, no. 1, pp. 186-209, 2009.
- [11] C. Fritz *et al.*, “Soloist evaluations of six old Italian and six new violins,” in *Proc. Nat. Academy of Sciences of USA*, vol. 111, no. 20, pp. 7224-7229, 2014.
- [12] R. Viala, V. Placet, S. Cogan and E. Foltête, “Model-based effects screening of stringed instruments,” in *Proc. Soc. Exp. Mech*, Series 3, pp. 151-157, 2016.
- [13] T. Hirsch, “Zur nachweisorientierten Rekonstruktion einer Renaissance-Viola da gamba nach Silvestro Ganassi,” in *BJb-HM*. Winterthur: Amadeus, 2016.

Violins, Pochettes, or Mute violins? *Shining a Light on the “Violins Without Sides”*

JONATHAN SANTA MARIA BOUQUET (1), SEBASTIAN KIRSCH (2),
MICHELA ALBANO (3), ARIANNA RIGAMONTI (4)

(1) St Cecilia’s Hall, University of Edinburgh, United Kingdom

(2) Germanisches Nationalmuseum, Germany

(3) Laboratorio Arvedi, Università di Pavia (CISRIC), Italy

(4) Musicology and Cultural Heritage Department, University of Pavia, Italy

Abstract

There are only three known extant examples of the “violins without sides,” all of which are currently held in musical instrument collections in Scotland: two in St Cecilia’s Hall (MIMEd 329 and MIMEd 5851) and a third in Dean Castle in Kilmarnock (A-54). Up until now, the lack of in-depth research on these three instruments has led to ambiguous attributions, conflicting dating and confusing taxonomical cataloguing. This paper will present the findings of new research in an attempt to provide scientific evidence to shine a light to these intriguing objects.

Fig.1



Fig.2



Fig.1 MIMEd 329.
Fig.2 Dean Castle DC-A54.

Fig.3



Fig.3 MIMEd 5851.

1. Introduction

This project encompasses the study of three instruments, all of which share a festooned outline,¹ and the particular trait of not having sides. That is, the soundboard is attached directly to the back. For this reason, they have been called “violins without sides”, or alternatively, “mute violins”, “practice violins” and “dance master fiddles”. To current date, however, it is not clear what exactly these instruments are. In all three examples, there is clear evidence that the original necks have been replaced, leaving a significant gap as to a number of basic organological traits, such as their number of strings, string length, and the shape and style of their peghead (if they had one at all).

The presence of f-holes, arched soundboard, and narrow centre bouts, together with the anchoring pin for a tailpiece identify them as bowed stringed instruments, nonetheless, the denomination of violin seems arbitrary. In the search for an organological denomination, the body length of these instruments could be associated with that of the *violino piccolo*, as explained by Dr Margaret Downie Banks² [1], however, this denomination does not account for their lack of ribs. Furthermore, Leopold Mozart wrote in his *Violinschule* [2] that the *violino piccolo* was useful in solo parts, and this is confirmed by a number of pieces of music written specifically for *violino piccolo*. The rather poor sound quality that results from the lack of ribs, makes this instrument unsuitable for a solo role and therefore not likely to be considered *violini piccoli*. Their sound is too loud for them to be considered mute violins, and the dimensions of their bodies makes them too large to be kits or pochettes, though it is interesting that the few other examples of instruments that could be described as “without sides” fall within either of these two denominations.³ In order to better understand these instruments, a research project was undertaken at St Cecilia’s Hall, with aims to clarify their dating, provenance, and attribution. This project comprises in-depth research with both historical and scientific approaches.

1 The upper and lower bouts are divided each in two lobes.

2 According to Banks these instruments fit “the second distinct size among small violins... with a body of about 30-31 cm”.

3 Some examples of these are: Viola d’amore kit c.1700, 89.4.2426, Metropolitan Museum of Art; Kit, probably eighteenth century, MIMEd 953, Edinburgh; Pochette by Mathias Wörle, 1691, NMM 4651, National Music Museum; Pochette, D41, Danish Music Museum.

2. Provenance

2.1. MIMEd 329

The first known provenance of this instrument can be traced to Charles Kirkpatrick Sharpe,⁴ a Scottish antiquary and collector born in Hoddom, Dumfries and Galloway, although he spent most of his life in Edinburgh. His collection, considered one of the great private collections of the nineteenth century in Scotland, was dispersed after his death to various beneficiaries under his will [3] and through two estate sales which lasted in total nearly a fortnight.

In the catalogue of the auction that took place on the 12th of June 1851, we find MIMEd 329 as Lot “401. Curious Old Violin without Sides. – (See Dalyell’s Musical Memoirs).”⁵ The instrument currently bears a label on its back with the same wording, so most likely it was attached in the sale to identify it. The reference on the label is to John Graham Dalyell’s “Musical Memoirs of Scotland” published in 1849, where he writes: “Mr. Charles Kirkpatrick Sharpe has a violin not by any means modern, consisting of only back and breast. Sides are wanting” [4]. On the back of the instrument is also another label located above the former, reading “UNIVERSITY OF EDINBURGH. Reid Bequest. Class of Music”. This relates to its purchase by Professor John Donaldson for the Music Department of the University of Edinburgh through the Reid Bequest on the 11th of October 1856 from Wood & Co [5]. In the ledger, it appears as “violin without sides”, but upon its accession to the University collection, it was catalogued as an “18th century practice violin”. Its description was later changed back to “Mute violin, violin without sides. Probably England. Possibly 17th century by Darryl Martin” [7], and it was attributed to Bassano by Benjamin Hebbert [8].

2.2. Dean Castle DC-DC-A54

Currently part of the collection of musical instruments at Dean Castle in Kilmarnock (MI/DC-DC-A54), this instrument was collected by Charles van Raalte likely at the end of the nineteenth century and kept with the rest of the collection in Brownsea Castle until van Raalte’s death in 1907. His daughter Margherita, who was a talented soprano, married the eighth Lord Howard de Walden, and although several instruments were sold after her father’s death, she brought with her to Dean Castle what she considered to be the most historically important examples in the collection.

4 There is no mention of this instrument on the published letters of the collector Charles Kirkpatrick Sharpe [6].

5 Charles Kirkpatrick Sharpe, *Catalogue of the highly and interesting collection of objects of virtue, prints ... of the late Charles Kirkpatrick Sharpe ... which will be sold by auction by Messrs. C. B. Tait & Nisbet ... June 12, 1851, etc.*, (Edinburgh, 1851), p. 16.

In 1927 there was an auction sale of the van Raalte collection of musical instruments at Brownsea Castle in Brownsea Island [9]. In the auction catalogue written by Canon Galpin is an instrument which could match DC-A54: Lot 1831, described as “Mute violin, probably English. 18th century. Length 20in., width 6in. Body without sides. Guitar shaped. 2 f-holes, ebony fingerboard with 16 brass frets. Scroll head. 4 strings. Used for practice purposes” [10]. Elements of this text are rather inconsistent with the current condition of the instrument, such as brass frets on the fingerboard or the “guitar shape” description. Although currently the fingerboard has no frets, the description could confirm the later replacement of the neck. There is also the possibility that the catalogue refers to a completely different instrument, also without sides, which was sold, in which case DC-A54 was not part of the sale, hence explaining its current presence within the collection at Dean Castle.

There are two catalogues of the Dean Castle musical instrument collections: one by Sotheby in 1975 [11], and one by John Downing in 1981 [12]. Both of them describe DC-A54 as: “A German mute violin, unlabelled, of eccentric outline, the two-piece back of with varnish of a golden brown colour, with simulated inked purfling and inked floral decoration on the back, total length 21 ¼ ins., 19th Century” [11].

2.3. MIMEd 5851

This instrument was purchased in auction on November of 2008 by the University of Edinburgh with help from the National Museums Scotland Annual Fund for Acquisitions. The auction catalogue listed it as “Lot 30. A KIT, CIRCA 1760” [13]. Unfortunately, to the present date, the provenance before this is unknown.

3. Comparing Outlines

In order to compare the outlines of the instruments tracings were created and then digitally manipulated. To obtain a reliable tracing of the outline of their bodies, all three instruments studied were placed on top of polyester drafting film, resting on pieces of synthetic rubber of the same height. These rubber supports allowed for the soundboard to lay parallel to the drawing surface, which could not be accomplished otherwise due to the arching back and angle of the neck. The outline was traced using a small try square to which a 0.5mm \varnothing pencil lead was secured using transparent tape. This system was employed to ensure that the lead (and thus the drawn line) was unequivocally perpendicular to the drawing surface, therefore producing an accurate tracing of the outline, whilst the tape protected the instrument from the lead and the square. Two control lines—one horizontal and one vertical—

Fig.4

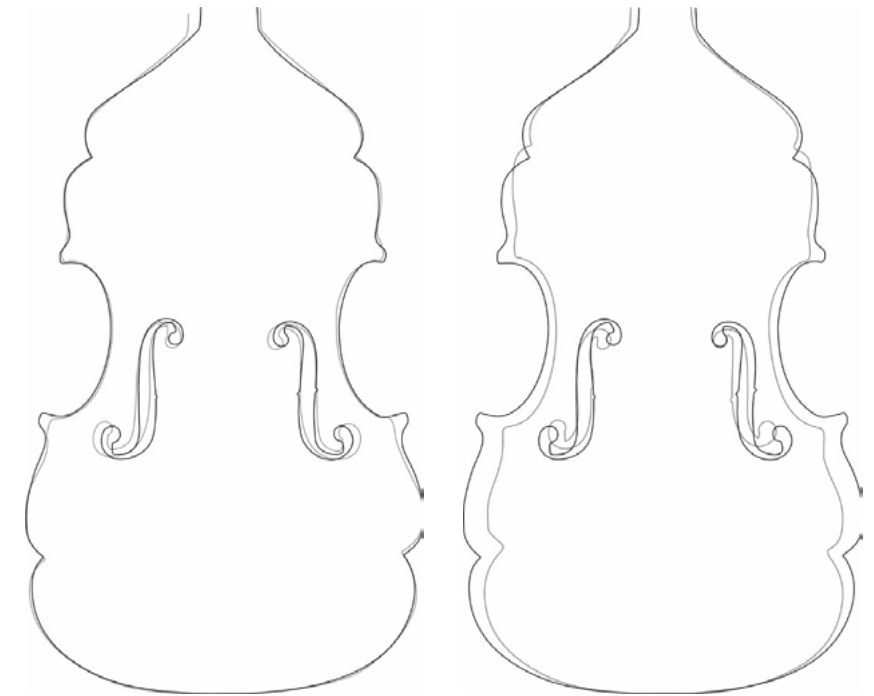

were drawn at specific lengths in the same piece of drafting film and then it was scanned. The digital version of the draft was exported to graphic design software where the pencil lines were redrawn digitally at 1:1 scale; the specific dimensions of the digitally drawn parts were established using the digital dimension tools of the software. All measurements were compared with and adjusted to the recorded physical measurements taken with callipers and rulers to ensure accuracy.

The f-holes were drawn based on photographs digitally modified to match the drawn outlines, cross referenced with images obtained with CT-scanning (excluding DC-A54 which was not scanned) and physical measurements. By comparison, it was possible to establish that the outlines of DC-A54 and MIMEd 329 are practically identical, the only differences most likely due to wear and missing material from the corners. The outline of MIMEd 5851 is significantly different from the other two, both in width and proportions. It is evident that this instrument was made using a different template. The one dimension that is constant in all three examples is the length of the body, all of which measure 312 mm.

Fig.4 Superposed outlines and f-holes. On the left MIMEd 329 (black) vs. DC-A54 (grey) and on the right MIMEd 329 (black) vs. MIMEd 5851 (grey).

The f-holes of MIMEd 329 and DC-A54 are very similar in shape and size, although their positioning in the soundboard is slightly different. Those in MIMEd 5851 are considerably smaller and of different shape, however the upper eyes are in roughly the same location in all three examples.

4. Decorative Elements

Apart from their clearly decorative outline, two of these instruments, MIMEd 329 and DC-DC-A54, present ornamental designs drawn with ink on the soundboard and back. Rather than the inlaid purfling commonly found on instruments of the violin family, these have a purfling-like line drawn with ink: a single line on the back and double line with decorative lines and dots between them in the soundboard. Additionally, following the lines of the body/neck joint, there are X-lines emulating stitches [Fig.5] [8].

Two flowers drawn on the back and top plates of DC-A54 [Fig.5] have been identified as Tudor-roses by Hebbert, who argues that, “The roses are of two different types and size, and their position surmounted on each other is representative of the Tudor roses of York and Lancaster” [8]. However, Tudor roses are a common design often found in traditional crafts, and these examples are clearly rudimentary ornaments rather than specific heraldic representations.

There are four insects rather crudely drawn onto each of the four corners of the front of MIMEd329 [Fig.6]. These have been identified as silk moths by Hebbert, who suggests they are the maker’s signature of the Bassano family, stating “when examined closely, these [insects] turn out to be anatomically specific, showing the hairy bodies and spotted wings specific to the silk moths” [8].

The Bassano are mostly known as makers of very high-quality woodwind instruments. However, historical sources confirm they also produced fine string instruments, and examples are noted in the inventories of the musical instruments owned by the king Henry VII [14], for whom Anthony Bassano worked officially as a maker.

The earliest Bassano family coat-of-arms dates back to 1540, and a later coat-of-arms of Anthony, Nowell and Andrea Bassano appears in 1633 in *The Visitation of London, Anno Domini 1633, 1634, and 1635, Volume 1* [Fig.7] [15]. The nature of the insects on this coat-of-arms have been discussed and contested since 1979 when Eleanor Selfridge-Field published “Venetian Instrumentalists in England: A Bassano Chronicle (1538-1660)” in which she states, “Anthony’s pedigree and arms (three silkworms and a laurel tree) were recorded in the Visitation of London in 1634” [16]. On the contrary, Peter Matthews argues that

Fig.5



Fig.6

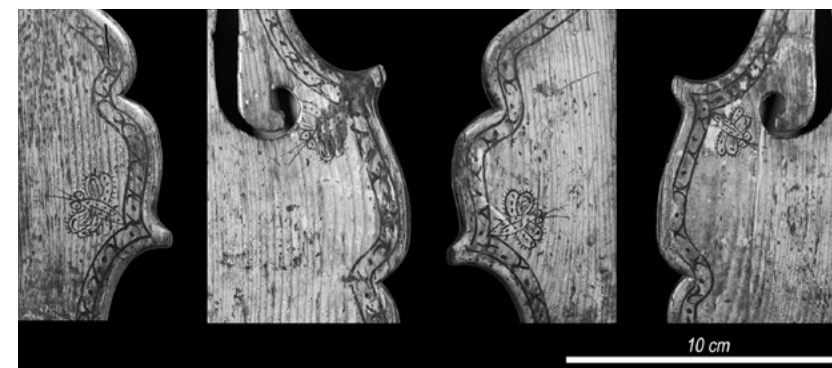

Fig.7

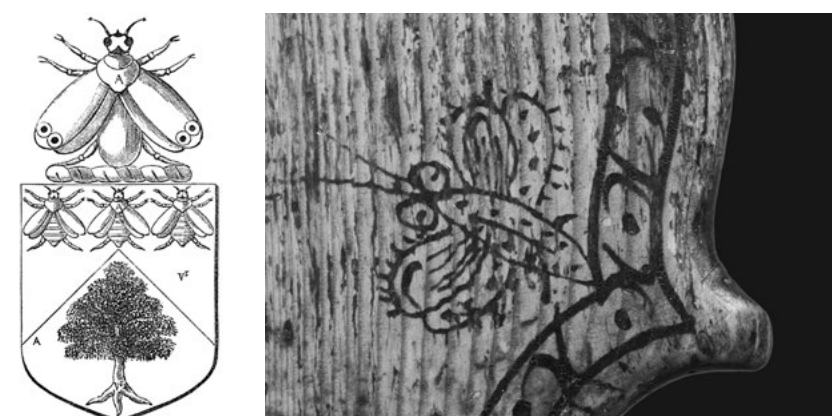

Fig.5 Decoration on the back of DC-A54.

Fig.6 Decorative elements on the corners of MIMEd 329.

Fig.7 Anthony, Nowell and Andrea Bassano’s 1633 coat-of-arms, *The Visitation of London, Anno Domini 1633, 1634, and 1635, Vol. 1* (left), and photograph of the corner ornamentation on MIMEd329 (right).

Fig.8

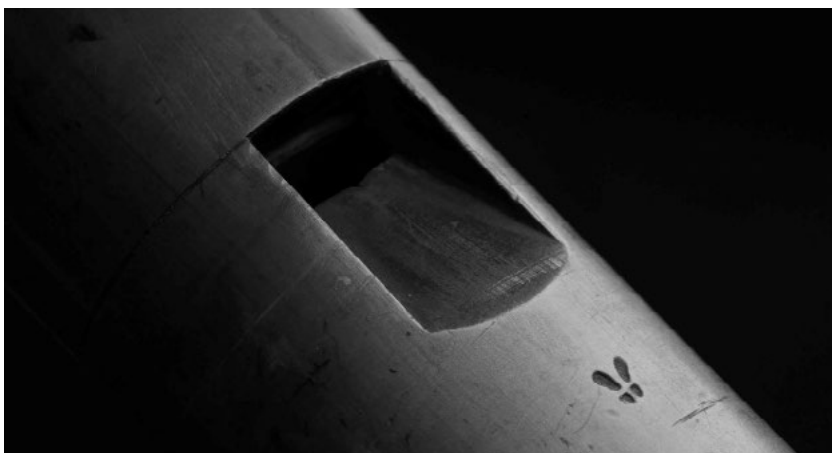
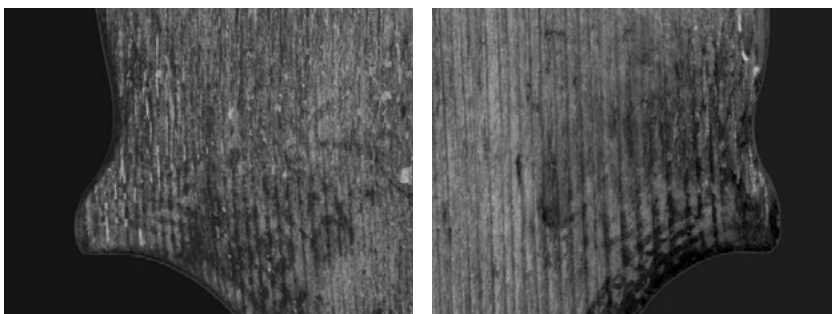

Fig.9



over time other scholars repeated Selfridge-Field's asseveration as a fact without examining the source for themselves, since "*The Visitation of London, Anno Domini 1633, 1634, and 1635, Volume 1* does not describe the coat-of-arms in any way, shape, or form" [17].

According to Matthews, the coat-of-arms "contains three drone-like honey bees over the Tree of Life" and "not until 1729 do we find the usage of three silkworm moths and a mulberry tree in a burial monument of Richard Bassano and family in the Lichfield Cathedral in Staffordshire, which is why modern scholars have assumed the silkworm moth and mulberry tree reflect all generations of Bassanos" [17]. Matthews explains this change as an attempt of one branch of the Bassanos which "diverged from their Jewish roots and conceded to English Masonry" [17], since the mulberry tree, silkworm moth and butterflies are all symbols of English Freemasonry.

Fig.8 Detail of the maker's mark on a tenor recorder by Bassano, Metropolitan Museum of Art 2010.205.

Fig.9 Decorative elements drawn on the corners of DC-A54.

Whether they are bees, flies, or silkworm-moths, the rather rudimentary caricature insects drawn onto the corners of MIMEd329 are not even remotely comparable to those depicted in the coat-of-arms of the Bassanos, and certainly not the same as the highly stylized makers' branding design found in numerous examples of their woodwind instruments produced in the sixteenth century [Fig.8]. They are more likely playful ornamentations in the same spirit of the "stitches" drawn in the body/neck joint of both MIMEd 329 and DC-A54.

An attribution to the Bassano makers based on this decoration seems rather tenuous, particularly if we take into account the high quality of the extant instruments made by the Bassano and the written sources that refer to them as master craftsmen who produced "instruments so beautiful and good that they are suited for dignitaries and potentates" [14, p. 212]. Certainly none of these three instruments fits that description.

The upper corners of DC-A54 also appear to have had some drawn decorative elements, unfortunately today these are almost completely obliterated. On the bass side, there are parts of what could be regarded as an insect slightly different than those on MIMEd329; on the treble side only a few lines are discernible and it is impossible to determine what was drawn [Fig.9].

5. CT Scanning

Two of the instruments (MIMEd 5851 and 329)⁶ were taken to the Advanced Materials Research Laboratory of the University of Strathclyde Glasgow to be scanned using an industrial micro CT-scanner.⁷ This imaging technique allowed us to understand their construction, materials and repairs, etc.

5.1 Construction

5.1.1. MIMEd 329

As a consequence of its construction without sides, this instrument is also built without blocks. Instead of grafting the neck to the upper block with a dove-tail joint, or a butt joint (in older instruments) as is

- 6 Due to practical and logistical complications, most of the scientific analysis was carried out on only the two instruments currently part of the Musical Instruments Collections of the University of Edinburgh. Further studies will be carried out on (DC-A54) to achieve more conclusive results.
- 7 Tube voltage: 150 kV, Current: 48 μ A, Single images per rotation: 3142, Exposure time: 708.00 ms, Spatial resolution: 146 μ m, CT-facility: Nikon XT H 225/320 LC Computer Tomography.

customary in violin construction, the back plate thickens substantially in this area to allow for the neck to be grafted in a v-joint (the sides of this joint are straight) [Fig.10]. Similarly, instead of having a lower block, an increased thickness of the plates creates a solid area to fasten the pin that will anchor the tailpiece.

On the inner face of the top and back plates there are deep tool marks made with a rather large carving tool, evidence of a rough and fast production process. These traces provide insight into how it was carved; several marks are parallel and show the procedure of the work steps [Fig.12]. There is no bass bar, nor are there any signs that there ever was.

The top plate is unusually thick, around 3.9 mm in most areas, reaching 4.2 mm in the centre of the top and under the tailpiece, 3.8 in the upper part and around the lower end of the f-holes, and increasing to up to 5 mm at the edges where it meets the back plate. The distribution of the thicknesses in the small range is nevertheless quite symmetrical and the rather thick top plate might be an attempt to make up for the lack of a bass bar. The quality of the soundboard wood is rather poor; the orientation of the annual rings is not quite radial, and this

Fig.10

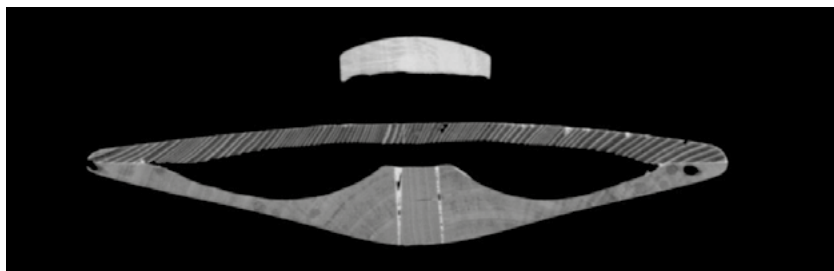

Fig.11

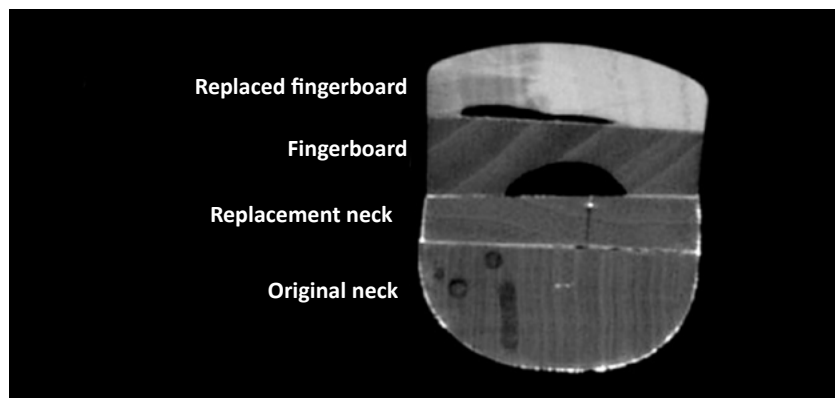

Fig.10 XCT image of the cross section of MIMEd 329 showing the neck graft, as well as construction features of the instrument's body.

Fig.11 Cross section of the neck of MIMEd 329 showing its different components.

is accentuated towards the edges where they become more tangential. A crudely-made soundpost connects the top and back plates.

The back is made of a single piece of plain sycamore in tangential orientation; its thickness is relatively even at c. 2.7 mm although it is rather thick around the centre (c. 3.5 mm). This evenness is disrupted by deep cuts made with a carving tool that resulted in a thin area of 1 mm. As previously described, thickness increases towards the neck joint, the bottom area where the tailpiece is fastened with a small wooden pin, and towards the edges where the back meets the soundboard.

The lower part of the neck appears to be original, as confirmed by the decorative drawn "stitches". The new section of the neck is joined with a lap joint reinforced with two screws. Cracks in the rest of the old neck indicate that a serious fracture made this measure necessary. The new neck ends in a very simple scroll. In the CT cross section, it can be seen that the new fingerboard made of ebony is glued onto a previous one probably made of sycamore [Fig.11].

Apart from one linen reinforcement on the back plate and some glued cracks in the top, there are no traces of major repairs on the inside of the instrument. Some worm holes are visible from the outside. It is noteworthy that the wormholes only appear on the treble side. Some of the larval tunnels end abruptly at the middle joint. This could be evidence that the wood was already damaged by the wood borer when it was used for construction.

5.1.2. DC-A54

Although this instrument was not analysed via CT scan, it is possible to establish that the construction techniques and features are practically identical to those found on MIMEd 329. There are rather rough tool marks on the inside of the plates, there is no bass bar, and it has a rudimentary soundpost. A noticeable difference is that unlike MIMEd 329, the back of DC-A54 is made of two joined pieces of sycamore—not a matching book-matched set, but rather two pieces of very plain wood joined at the middle.

The original base section of the neck is still attached to the body; a new neck, peghead and scroll, aesthetically consistent to those found on the violins of the Cremonese school, are grafted to the original neck with a v-joint around the middle of the neck. The fingerboard is consistent with that of a nineteenth-century violin and it partially covers the decoration of the soundboard, thus it is likely that the original fingerboard was shorter. Currently this instrument has a bridge branded with the maker's mark of W. E. Hill & Sons; in view of that, it is plausible to think the current neck, together with the fingerboard, tailpiece and pegs were also replaced by the Hills. However, the craftsmanship of the scroll and the joint which are better executed than others, is evidence that these modifications were made at different stages and by different

Fig.12

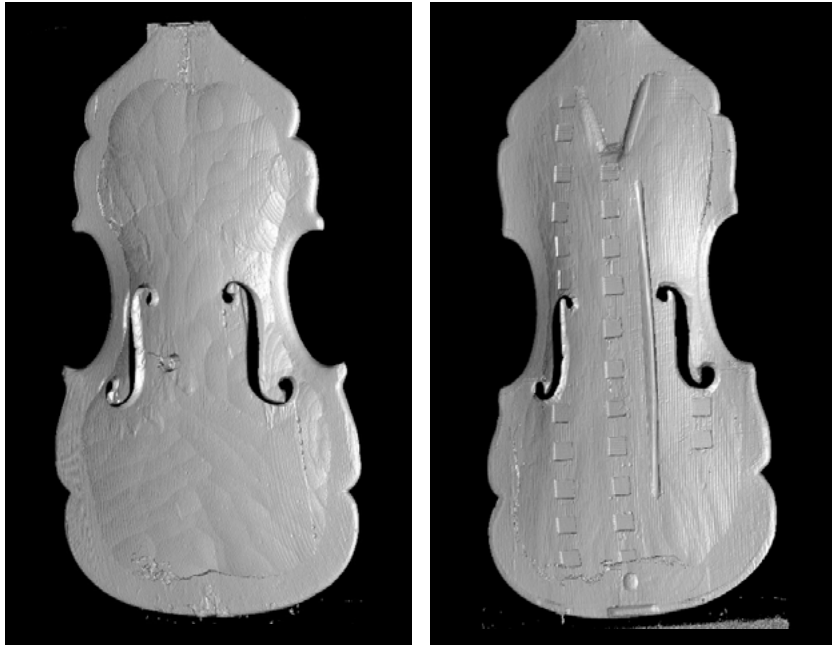

Fig.13

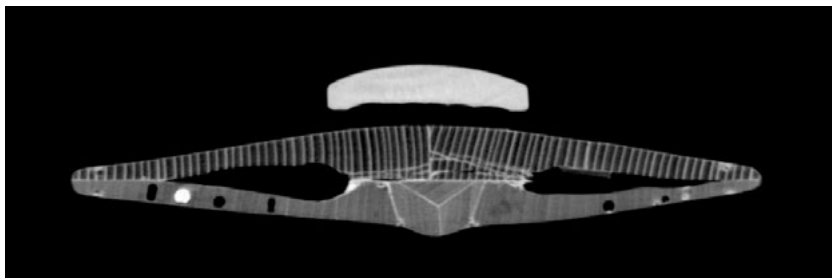

Fig.12 Digital reconstruction from the XCT imaging of the inner face of the top plates of MIMEd 329 (left) and MIMEd 5851 (right).

Fig.13 XCT image of the cross section of MIMEd 5851 showing the neck graft, as well as construction features of the instrument's body.

people. The current reddish varnish covers the body as well as the new neck and peghead, indicating that it is as a later addition, probably applied when the neck was replaced.

5.1.3. MIMEd 5851

A new neck is grafted almost to the base of the original neck. The current peghead ends in a small scroll of rather crude manufacture which appears to be relatively old and consistent with the aesthetics of the instrument. The fingerboard consists of one piece of ebony, and the tailpiece (of recent manufacture) is fastened to an ivory button at the bottom back plate.

The top plate consists of two bookmatched pieces of coniferous wood, most likely spruce. The quality of the wood and the orientation of the grain is of significantly better quality than those of the other two instruments studied. Nonetheless, on the inside, tool marks are visible and were left unfinished, although they are slightly smoother than those found in MIMEd 329. A small bass bar with annual rings parallel to the soundboard is glued under the top plate (**Fig.12**). The area around the bass bar is thinner and evenly carved, which shows the bass bar was carefully fitted. Despite the rough appearance of the inner surface, the distribution of thickness seems to be systematic. The top plate's thicknesses are somewhat consistent with those of a classical violin, slightly thicker in the middle (3.3 mm to 3.9 mm), thinner in the outer areas (2.1 mm to 2.4 mm) and thicker again where it is glued onto the back plate. The f-holes have a noticeable undercut.

The back consists of two bookmatched pieces of sycamore and presents tool marks similar to the top plate on the inner surface. Its thickness is quite uneven, varying between areas as thin as 1 mm to a maximum of 2.3 mm. Like the top plate the thickness increases at the edges. Both the top and back plate are framed by a thin purfling shallowly inlaid (only 1-1.5 mm deep in some areas).

It is evident that the instrument was opened at least once to perform several repairs. On the top plate, the middle joint, one long crack on the treble side and a shorter on the bass side have been repaired and are supported by wooden reinforcements.

On the back, some of the thinner areas resulted in cracks which are also reinforced from the inside. The centre joint is supported by small wooden cleats, and larger wooden patches appear at the bottom and the area next to the upper corner on the bass side, where very thin areas are reinforced. Wood worm damage appears mainly in the sycamore parts of the instrument, quite severe in the scroll and the back plate and moderate in the soundboard. XCT imaging shows the new neck is grafted very close to the base of the original neck and contrary to the v-joints of the two other examples, the walls of the inserted piece are angled forming a sort of dovetail joint [**Fig.13**].

Fig.14

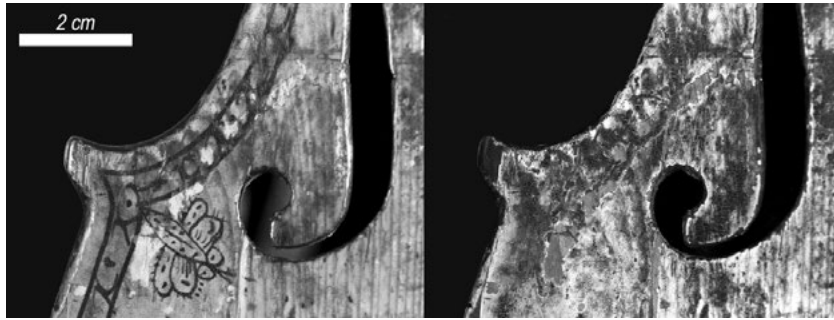

Fig.15

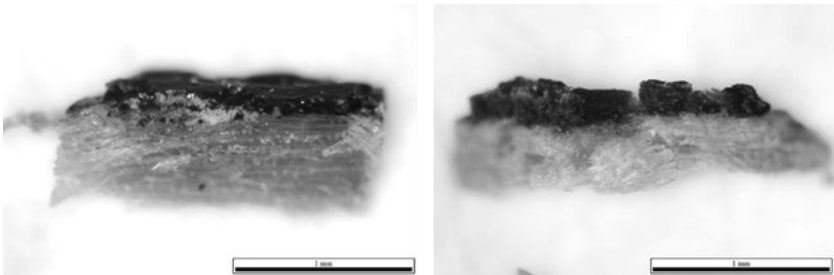

Fig.16

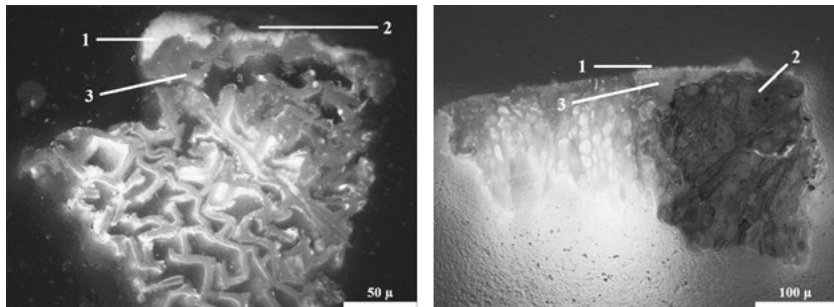

Fig.14 Image of the lower bass corner under visible light (left) and under UV spectra (right).

Fig.15 Stereo microscopy images of the sample of purfling from MIMED 329 (left) and MIMED 5851 (right).

Fig.16 Cross section images of fluorescence induced by UV of MIMED 329 (left) and MIMED 5851 (right).

5.2 Dendrochronology

The growth rings of the soundboard of MIMEd 329 and 5851 were measured from CT-scan imaging of the cross sections at their widest points. Unfortunately the small number of rings available did not allow for reliable dating results. Several specialists were contacted in relation to this issue, and the results were altogether non-conclusive with regards to their dating.

On MIMEd 5851, we were able to measure only 53 rings on the bass side and 58 on the treble side of the soundboard. According to Peter Ratcliff, “The correlation between the data from the two sides is extremely low, and may not actually represent a true temporal match.”⁸

Similarly in MIMEd 329, only 68 rings on the bass and 64 on the treble side were measured. Ratcliff states, “The two halves of this instrument, however are related and likely from the same tree, although they are offset from each other by 10 years at the end. But even by combining their data which gives us a series of 76 rings, there are no reliable batches of correlations to allow dating”. From this analysis we can establish that the two pieces forming the soundboard of MIMEd 329 might not be a bookmatched pair, contrary to MIMEd 5851.

6. Varnish Analysis

Spectrographic research was carried out on MIMEd 329 and 5851 by means of photographic documentation, both in the visible range spectra and in ultraviolet (UV) induced fluorescence. In addition, spectroscopic and micro-chemical analyses have been performed in order to characterize the materials in the varnish of both instruments and to compare the results.

The UV images show two different surface treatments. Both instruments appear to have an outer layer of a whitish-yellow material, maybe residue of a finishing agent or polish applied in previous restorations that covers several areas of the top plates. Underneath this white-yellow layer, MIMEd 329 reveals a brighter yellow-coloured layer under the tailpiece area which appears to indicate the presence of a possible exposed section of original varnish. The back of the instrument also shows a brighter yellow fluoresce under UV. Between the f-holes and under the fingerboard, there is a widespread dark fluorescence typical of bare wood, suggesting the absence of varnish on those areas. The decorative elements are clearly drawn under the varnish, probably applied directly to the wood [Fig.14].

On MIMEd 5851, a brown-orange varnish is visible and evenly spread across the top plate surface except between the f-holes, where the dark colour of fluorescence highlights the absence of varnish.

⁸ Email conversation with Peter Ratcliff on 4/4/2018.

Fig.17

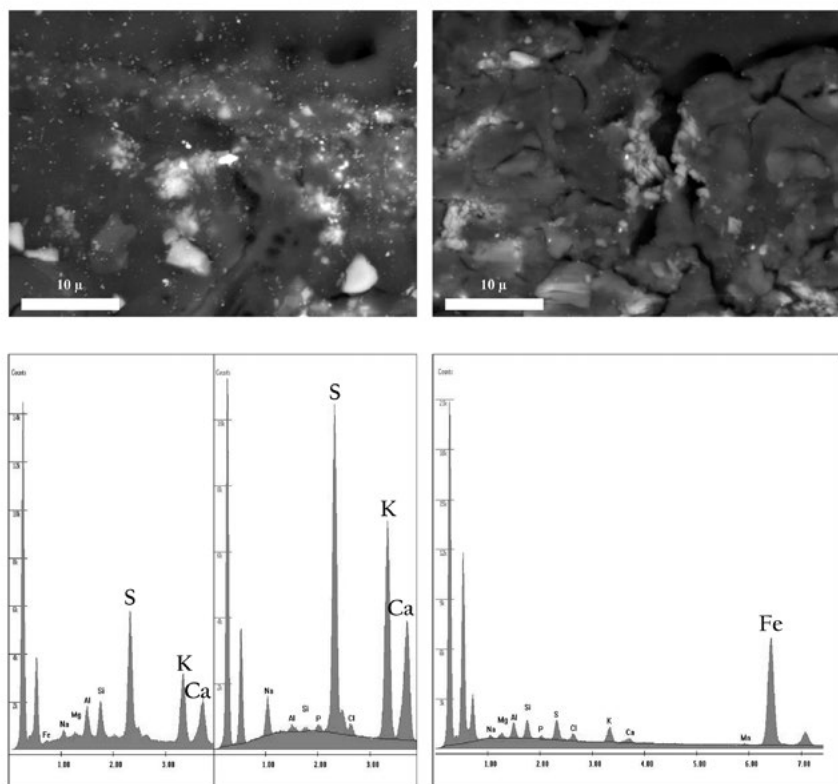

The differences in the varnishes and surface treatments between the two analysed instruments are very clear under UV fluorescence and show the evidence of substantial wear, attesting for both instruments that at some point they were regularly played.

In order to better understand the differences in the constituents of the coating of these two instruments, two micro samples from the purfling area of both instruments were taken, sampling at the same time the varnishes and the treatments of the top plates. **Fig.15** shows the micro-sample images taken by stereo microscopy at high magnification, where the differences in the black layer of the purfling can be appreciated. In the MIMEd 329 sample (left) the black material seems just to cover the wood and appears shiny and well distributed. MIMED 5851 sample (right) clearly shows the presence of black wood applied on the wood of the top plate, which confirms the inlay purfling technique.

Fig.17 SEM-EDX results: a) SEM images of MIMED 329 (left) and MIMED 5851 (right) cross sections; b) EDX results of the white materials from both instruments; c) Iron emission peaks related to the black purfling of MIMEd 329.

These results can be confirmed by the study of the cross sections of the samples carried out by optical microscopy at 100x magnifications (**Fig.16**). In the image of the MIMEd 329 cross section taken under UV induced fluorescence (left), it is possible to evidence the presence of the white materials (point 1) with the black decoration (point 2) that, in turn, seems to cover the wood layer (point 3). In this image it is evident that the black layer is a thin coloured material applied on the wood ground, confirming the presence of a decoration technique to imitate the purfling. In contrast, the cross section of the MIMED 5851 sample (right) shows the same white material (point 1) spread on the surface of both the black wood (probably ebony) of the purfling (point 2) and the brown-orange varnish layer (point 3).

Finally, the cross sections of the samples have been analysed using Scanning Electron Microscopy (SEM) at higher magnifications in order to better understand the distribution of the materials and to characterize the pigments or particles via an Energy Dispersive X-Ray (EDX) analyser that can provide information about the elements present in the cross section [**Fig.17**].

The results highlighted in **Fig.17(a)** show a similar distribution of the white materials spread on the wood (SEM images), and this behaviour is confirmed by the EDX analysis that shows the same elemental composition for this material in both instruments, with peaks related to sulphur, potassium and calcium [**Fig.17(b)**]. This elemental composition confirms the use of sulphates of K and Ca with the aim of preparing the surfaces. The overlapping of both spectra indicates that both instruments underwent the same treatment but not necessarily with the same materials. In the case of the MIMED 5851 spectrum, even signs of the presence of feldspar are evident, which could be correlated to the use of earth as a pigment for the brown-orange varnish. The analysis performed on the black area of the purflings [**Fig.17(c)**] revealed a high iron content in MIMEd 329, consistent with the use of an iron-based ink to decorate the top plate (probably an iron-gall ink), while the emission peak of iron in the purfling of MIMED 5851 is very low, suggesting the use of an undyed, natural wood, probably ebony.

7. Conclusions

Based on the research carried out, it can be established that MIMEd 329 and DC-A54 were most likely made by the same maker using the same template. On the other hand, although MIMEd 5851 is probably the same kind of instrument and shares the same body length and style, there are enough differences in design, construction method, and wood choice and quality, to establish that it was not made by the same person. There is no doubt that two violins of the classical school of Cremona with differences in size, construction style, and outline as those found between MIMEd 329 and 5851 would never be attributed to the same maker. It is understandable that the rather small number of instruments with these characteristics makes it tempting to attribute them to one maker or workshop, but given the physical evidence to the contrary, this appears not to be the case.

The inked decorations on MIMEd 329 and DC-A54 appear to be craft style ornaments in line with those found in traditional instruments like fiddles. Similarly, the rather crude carving with tool marks left visible on the internal side of the body is consistent with traditional instrument-making, and not the work of a member of a family considered “among the most important wind instrument makers of the sixteenth and early seventeenth centuries” [14]. Unfortunately, at this time we were not able to provide answers to our initial questions: what are these instruments, who made them and when? Further study will be necessary to reach more conclusive results.

ACKNOWLEDGEMENTS: Jason Sutcliffe, Linda Fairlie, Dr. Darryl Martin, Peter Ratcliff, Dr. Katarina Čufar, Dr. Michael Grabner, Dr. Micha Beuting, Dr. Marco Malagodi, Fausto Cacciatori, Dr. Massimiliano Guido, Luca Rocca, Dr. Sarah Deters.

This project was partially funded by the Thompson-Dunlop Bequest.

References

- [1] M. D. Banks, “The violin piccolo and other small violins,” *Early Music*, vol. 18, no., pp. 588-596, Nov. 1990.
- [2] L. Mozart, *A Treatise on the Fundamental Principles of Violin Playing*, trans. Editha Knocker. Oxford: Oxford University Press, 1951.
- [3] P. Cadell, “Sharpe, Charles Kirkpatrick,” *Oxford Dictionary of National Biography*. [Online]. Available: <http://www.oxforddnb.com/>
- [4] J. G. Dalryell, *Musical Memoirs of Scotland, with Historical Annotations and Numerous Illustrative Plates*. Edinburgh: T.G. Stevenson, 1849.
- [5] A. Myers, *Historic Musical Instruments in the Edinburgh University Collection, Catalogue of the Edinburgh University Collection of Historic Musical Instruments, Vol. 2, Part K, Ancillary Equipment*. Edinburgh: University of Edinburgh, 1995.
- [6] C. K. Sharpe, *Letters from and to Charles Kirkpatrick Sharpe*, ed. Alexander Allardyce. Edinburgh: W. Blackwood, 1888.
- [7] A. Myers, *Historic Musical Instruments in the Edinburgh University Collection, Catalogue of the Edinburgh University Collection of Historic Musical Instruments, Vol. 2, Part C, Fascicle i: viols and violins*. Edinburgh: University of Edinburgh, 1995.
- [8] B. Hebbert, “The British Museum citole as a 16th-century violin. Context and attribution,” in J. Robinson, N. Speakman and K. Buehler-McWilliams, Eds., *The British Museum Citole: New Perspectives*. London: The British Museum Press, 2015.
- [9] E. Van Der Straeten, “Sale of the van Raalte collection of old instruments,” *Musical Times*, vol. 68, no. 1014, p. 712, Aug. 1, 1927.
- [10] C. Galpin, *Auction Sale of the Contents of the Mansion. The van Raalte Collection. Brownsea Castle*. Brownsea Island: Fox & Sons, 1927.
- [11] Sotheby’s & Co, *Dean Castle Kilmarnock. An Inventory and Valuation of the Charles van Raalte Collection of Musical Instruments. Made for the Purpose of Insurance*. London: author, 1975.
- [12] J. Downing, “An inventory of the Charles van Raalte collection of instruments,” *Fellowship of Makers and Researchers of Historical Instruments Quarterly*, vol. 24, pp. 57-72, July, 1981.
- [13] Bonhams, *Fine Musical Instruments, Lot 30: A KIT, CIRCA 1760*, Nov. 4, 2008. [Online]. Available: http://www.bonhams.com/auctions/16013/?bid_lot_no=3471962#/MR0_length=50&w0=list&k0=30&aj0=lot_number_asc&m0=0
- [14] D. Lasocki and P. Roger, *The Bassanos: Venetian Musicians and Instrument Makers in England, 1531-1665*. Aldershot: Scolar Press, 1995.
- [15] H. and R. St. George, *The Visitation of London, Anno Domini 1633, 1634, and 1635, Vol. 1. Publications of the Harleian Society*. London: Mitchell and Hughes, 1880.
- [16] E. Selfridge-Field, *Venetian Instrumentalists in England: A Bassano Chronicle (1538-1660)*. Florence: Leo S. Olschki, 1979.
- [17] P. D. Matthews, *The Bassanos Jewish Guardians of the Ancient Arts*, [Online]. Available: <http://petermatthews.com.au/wp-content/uploads/2017/01/PAPER-v2-The-Bassanos-Jewish-Guardians-of-the-Ancient-Arts.pdf> Accessed on: March 30, 2018.

Virtual Experiments on Stringed Wooden Instruments: *Influence of Mechanical and Climate Loading*

DANIEL KONOPKA, MICHAEL KALISKE

Institute for Structural Analysis, Technische Universität Dresden, Germany

Abstract

This chapter presents an introduction to the finite element modelling of wooden artefacts. Numerical simulation enables investigation of critical loadings or construction details in a non-invasive and objective analysis. Thus, it may help to define restoration or conservation actions, such as assessing the playability of an instrument or defining appropriate climate ranges. Wood characteristics need to be considered with appropriate material models. On several keyboard instrument models, the internal mechanical behaviour at externally applied mechanical forces (string tension) and climate loadings (climate changes) are analysed. Based on the developments at the Institute for Structural Analysis, the material models for elasticity, plastic failure under compression as well as brittle failure and moisture transport with respect to time- and moisture-dependency will be presented for concrete examples. Different string and climate load cases on instruments and details are selected to visualise the function of the introduced models and to offer insight into the load-bearing and structural analysis.

1. Introduction

Museums with collections of historical music instruments are in conflict between conserving the original substance and maintaining the original use. Playable stringed keyboard instruments, in particular, are complex wooden structures under heavy mechanical loading. Hygrical loadings as alternating climate conditions induce additional mechanical loadings and influence the physical properties enforcing damage to the structure like large deformations and cracks.

The preservation of wooden cultural heritage is of eminent importance, as pointed out by this book and a large number of further, recent publications on scientific experimental and numerical investigations of the mechanics and hygroscopicity of panel paintings (e.g., [1, 2, 3, 4, 5]), wooden musical instruments (e.g., [6, 7, 8, 9, 10, 11, 12, 13, 14]) and even shipwrecks (e.g., [15, 16]). In recent years, the investigation of complex structures in general and historic wooden musical instruments in particular has been strengthened by a further powerful tool for structural analysis with respect to the load-bearing behaviour at several external loadings, such as mechanical forces or environmental climate conditions. Due to the development of powerful computers also on the level of common work stations, computational engineering and the numerical simulation has become a standard in the repertoire of structural analysis. Complex object geometries and loadings, high nonlinear structural interactions and material behaviour as well as the comprehensive consideration of multi-physical aspects as mechanical and climate issues need to be considered. Therefore, the Finite Element Method (FEM) is predestined for the numerical solution of multi-physically coupled, nonlinear differential equation systems.

In principle, the FEM offers a broad spectrum of imaginable structural analyses: Dynamical FE-analyses enable wave propagation and vibration simulation or modal analysis, which is necessary for numerical characterisation of an instrument's tone and acoustics. Static analyses enable the simulation of the load-bearing behaviour at multi-physical conditions and in the short- and long-term range. The analysis of stresses, deformations, risk of failure, stability and durability, etc. are feasible.

Together, experimental analysis tools and the FE-analyses complement each other. On the one hand, experiments on materials and structures, for example, are necessary to validate numerical models. On the other hand, numerical methods help to avoid destructive or invasive experimental tests. Moreover, it is possible to gain insight into the invisible internal load-bearing behaviour at current conditions or to predict future behaviour. Therefore, the material properties need to be known and the material models have to be adequate for the aimed issue, yet as simple as possible to reduce the numerical effort.

The chapter at hand is thought to provide an introduction into the opportunities of FE-modelling with respect to load-bearing behaviour, i.e. static analysis. Different issues of load-bearing behaviour of stringed wooden musical instruments at hygro-mechanical external loading are presented step by step based on examples analysed at the Institute for Structural Analysis. The presented material, FE models and analyses are based on developments and analyses of the institute. The approach at hand is to develop a simulation tool for wooden structures using consistent and comprehensive multi-physical modelling of the material and structural behaviour, starting with elastic material characteristics.

2. Finite Element Modelling and Analysis of Wooden Musical Instruments

The recent field of research by the Institute for Structural Analysis described in this chapter is focused on two kinds of structures with respect to external loads: 1) purely hygrically loaded structures, such as furniture and panel paintings [21], and 2) more complex stringed wooden musical instruments, such as pianofortes [22, 23, 24], violins or guitars. The latter class, additionally loaded by mechanical forces, is strongly susceptible to plasticisations and creep deformations, intensified by moisture-dependent mechano-sorptive effects.

The focus of this paper is the presentation of structural analyses of heavily-loaded wooden instruments. The investigated structures are subjects of research in recent cooperations with the Stiftung Händel-Haus, Halle. To provide easy access to the opportunities offered by FE-modelling, several features of the complex structural behaviour with respect to mechanical and hygrical loading are discussed step by step using concrete simulation examples. The effects of elastic and failure properties of wood depending on moisture content and their consequences on the structural scale are described in Section 2.2. Time-dependent, transient analyses consider the diffusion-based consequences of unsteady moisture distributions in the structure in Section 2.3. As stated above, the numerical models and simulations presented show the current state of development in complex structural analysis at the Institute for Structural Analysis. Further analyses of moisture-dependent, long-term behaviour are planned.

2.1 Finite Element Method

The concept of the finite element method is to discretise a volume into finite sections, which is also called meshing. These sections or elements have at least one node in each corner. Commonly applied elements consist of tri- or tetragonal faces. In the three-dimensional case, the volume is often discretised into tetraeder or hexaeder solid elements. Furthermore, surface elements for interaction with the environment

Table 1

Category	Material Property	Modelling Models/Assumptions	Parameters	
Statics	Static/Stationary (short-term)	Mechanics	Elasticity - Orthotropic elasticity (e.g., [17]) - (average of ij and ji-components) - micro-model: $E(\rho, m)$ - constant Poisson's ratios	E, G ν
			Ductile inelasticity - Multi-surface plasticity (e.g., [17]) - limit of elasticity ("compression strength") - quadratic approximation $f(m)$ - damage function (softening/hardening)	f_c $q(\alpha)$
			Brittle fracture - Interface-element formulation + cohesive material formulation (e.g., [17]) (<i>XFEM, Phase field model</i>)	f_t, f_{shear} G_c
			Hygro-expansion (swell/shrink) - differential shrink number (e.g., [17]) - constant	β
		Hygroscopy	Sorption - Sorption-isotherme (Avramidis) (e.g., [17]) - material independent - without hysteresis - Sorption-hysteresis (e.g., [18]) - history dependent	EMC = $f(RH, T)$
			Hygro-elasticity - not considered (missing reliable knowledge)	
	Thermal energy - not relevant for application range - not considered (so far)			
	Quasi-Static/Transient (long-term)	Mechanics	Visco-elasticity [27] - creep number (const.) - relaxation time (const.)	ϕ τ
			Visco-plasticity [27] - vp stiffness - Tsai-Wu yield criterion - limit of linearity	η^{vp} , $LL(m)$
			Mechano-sorption [28] - strain rate factor - modified hygro-expansion	κ β_{mod}
			Creep failure [27] - strain rate energy - critical strain rate energy	e e_{crit}
		Hygroscopy	Diffusion - multi-Fickian diffusion (Frandsen) (e.g. [19]) - micro-model	$D_b(m)$, $D_v(m)$
Sorption - sorption rate (e.g., [19])			$\dot{c} = \partial c / \partial t$	
Surface emissivity - Boundary layer theory (e.g., [19]), - Varnish permeability (e.g., [20])			l, v p_t	
Thermal energy - heat conduction, surface convection - not considered (so far)				
Dynamics	Mechanics - stiffness, damping, mass - fatigue			
	Hygroscopy - unknown			
	Thermal energy - unknown			

Table 1 Material modelling of wood – Categorisation and applied models

Fig.1

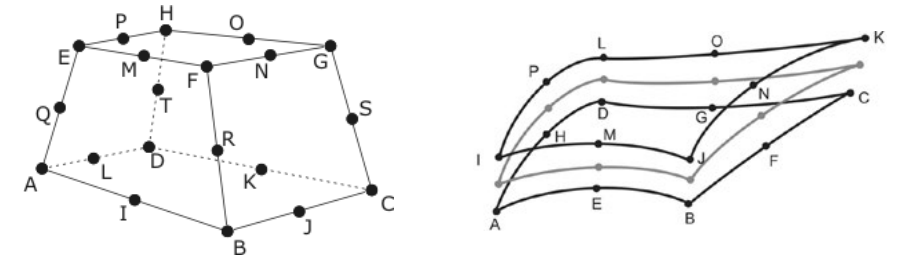

(surface forces or heat and moisture transfer, see Section 2.3) and interface-elements are needed for the inhere analysed three-dimensional structures. Interface-elements enable the consideration of cracks by opening the initially coincident nodes of the lower and upper sides if the material strength is exceeded (see Section 2.2.3). In Fig.1, the applied solid and interface elements for the spatial discretisation of the keyboard instruments in this chapter are illustrated. They have an additional node at each edge. The three nodes per edge enable a quadratic shape function of the structural response instead of a linear shape for 8-node solid or 8-node interface elements. Each node has a certain number of degrees of freedom (DOF), i.e. the unknown characteristics, which need to be determined within the numerical solution. The number and kind of DOF depend on the targeted results. Common DOF are the displacements in all spatial directions and, furthermore, properties like moisture content, temperature, electric or magnetic field quantities etc.

Considering the investigated hygro-mechanical interactions, the contribution of one node to the equation system contains the unknown three-dimensional vector of the displacements \mathbf{u} and the moisture \mathbf{m}

$$\begin{bmatrix} K_{u,u} & K_{u,m} \\ K_{u,u} & K_{u,m} \end{bmatrix} \begin{bmatrix} \mathbf{u} \\ \mathbf{m} \end{bmatrix} = \begin{bmatrix} \mathbf{F}^{apl} \\ 0 \end{bmatrix} - \begin{bmatrix} \mathbf{F}^{nr} \\ \mathbf{F}^m \end{bmatrix}, \quad (1)$$

with the components of the compliance matrix $K_{i,i}$ and the vectors of external (applied) minus internal loads on the right-hand side. Depending on the applied material models, \mathbf{m} may consist of multiple field quantities (see Section 2.3). The total equation system of the analysed structure now contains the sum of all equations of all nodes, i.e., the product of nodes and DOF per node in Eq. (1). Due to mutual nonlinearities, the total load cannot be applied at once. Instead, sub-steps have to be introduced with a smaller percentage of the loadstep. In every sub-step, the equation system will be solved with estimated and updated DOF-values in several iterations until the total error is small

Fig.1 Finite elements: 20 nodes solid and cohesive 16 nodes interface elements.

enough and has fallen below a defined convergence tolerance. In terms of time-dependent simulations, the time will be discretised into intervals, too. That means, the number of solutions is again multiplied by the number of time steps.

2.2 Analysis of a Historic Pianoforte – Static/Stationary Wood Material Properties

Fig.2

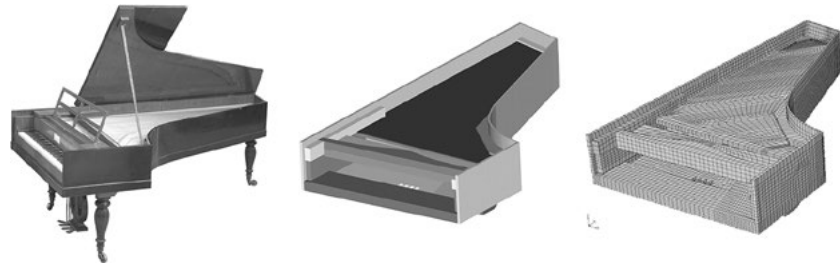

In the first example, a pianoforte is investigated with respect to the influence of tensioned strings and time-independent, i.e. stationary effects of the wood's moisture content on the mechanics. The *Hammerflügel* MS-44 in Fig.2 by Conrad Graf (1835) is object of interest in previous publications (e.g., [24]). The figure shows the original structure in its current, deformed state, a simplified volume model reduced to the undeformed load-bearing structure, and finally the analysed, discretised (meshed) FE model.

The volume model already shows the single parts of the structure in different shades. Based on these parts, specific material properties are assigned to every element in the FE model. The elements at the location of the iron brace receive the characteristics of iron. The wooden parts have information on the wood species and material directions (longitudinal, radial, tangential). With the specific material models, the whole structural behaviour can be described.

The static analysis deals with the time-independent phenomena. With respect to the equation of motion, all observed phenomena are balanced immediately without any movement. Velocity and acceleration terms disappear. Stationary moisture diffusion and heat conduction lead to constant moisture and temperature values over time for every material point with constant flux.

Fig.2

Hammerflügel MS-44 (Stiftung Händel-Haus, Halle): current geometry, three-dimensional volume model and FE model.

2.2.1 Moisture dependent material models

Fig.3

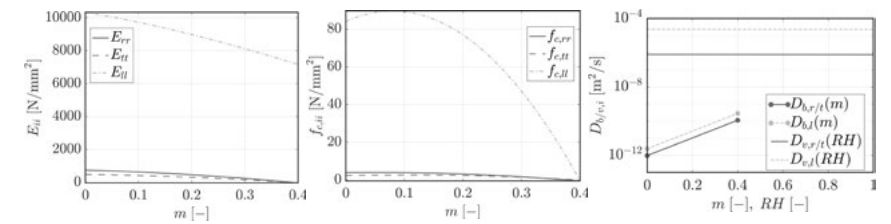

The internal resistance to any applied loading state is defined via the specific material characteristics. Thus, in the scope of a realistic three-dimensional analysis by the FEM, the material behaviour needs to be known and appropriate material models formulated. Wood is an inhomogeneous, anisotropic and porous material with moisture-, temperature-, time- and stress-state-dependent behaviour (e.g., [25]). Appropriate material models for the description of the macroscopical, mechanical response to multi-physical loadings are required. Structural analysis input parameters, such as Young's moduli and Poisson's ratios to describe the elastic characteristics or material strengths for failure behaviour, and diffusion parameters, such as diffusion coefficients for moisture transport inside the material are needed. Due to the hierarchical structure of wood with the cells at micro-scale, early and late wood at meso-scale up to the wooden construction parts, sawn out of a tree with its cylindrical material coordinate system at the macro-scale, adequate modelling of the macroscopical behaviour with a minimum of numerical effort is a challenging task. When possible, the applied models in this chapter (see Table 1) are based on clear, detectable physical material parameters, rather than fitted phenomenological functions. If necessary, multi-scale models help to consider smaller scales of the hierarchical material structure (e.g., coefficients of elasticity or transient diffusion models). Detailed descriptions of the applied models are published in the cited references in Table 1.

Depending on the analysis purpose, the uncertainty of the material parameters, for example, due to natural variation as well as climate- and time-dependent input quantities can be considered. Compared to moisture, temperature-dependency plays a minor role within standard climate conditions. To visualise the massive influence of moisture content on wood material properties, selected applied material direction and moisture-dependent material model parameters are shown in Fig.3. The diffusion coefficients are presented here for the two-phase

Fig.3

Selected material parameters for spruce ($\rho_0 = 0.38 \text{ kg/m}^3$), depending on moisture and material direction $i \in \{r, t, l\}$: Young's moduli E_{ii} , compression strengths $f_{c,ii}$ and diffusion coefficients of bound water $D_{b,i}$ and water vapour $D_{v,i}$ (log. scale)

multi-Fickian diffusion model. While the bound water diffusion is related to moisture content m (mass of water per mass of wood), like all wood-specific material parameters, the water vapour diffusion coefficient is related to vapour pressure and relative humidity RH . A recent review on material modelling of wood with special focus on musical instruments is presented in [17]. A survey (in German) on developed moisture-dependent wood material models within the scope of FEM, including a comprehensive survey of experimental data for most of European wood species commonly used in musical instruments, is given in [20].

2.2.2 Elastic deformations and hygro-expansion of a pianoforte with respect to moisture content

The above structure of a pianoforte is chosen to visualise the influence of moisture-dependent elasticity of wood on structural behaviour. The pianoforte is mechanically loaded by the tensioned strings at the pins carrying the loads into the load-bearing wooden frame-system. These forces are determined for an original, historic tuning of chamber pitch $a_1 = 450$ Hz. The climate conditions are chosen as the observed limit values in the exhibition room as a dry climate in winter (RH/T : 40%/18°C) and maximum possible climate conditions (RH/T : 70%/28°C), corresponding to a thunder-storm in summer.

Three cases are analysed, the first at a constant winter climate and the second at a constant summer climate. The third case considers a quasi-stationary increase of moisture from winter to summer load case. This means that the influence of swelling is considered, but not any transient phenomena due to the time-dependent inequilibrium of moisture over the structure's volume (see Section 2.3). The reduced FE-model is described without the bondlines and veneer layers (see Section 2.3.3).

Fig.4 depicts the deformations in vertical direction of the whole load-bearing structure (excluding the soundboard), while **Fig.5** shows the displacement along the path on top of the side walls. The differences between the winter and summer case are marginal, but show an interesting shift of the flux of forces, combined with a different deformation figure. Although the wood's stiffness is reduced with increasing moisture, some regions show smaller displacements. At the same tuning, but considering the swelling during adsorption, the distinct magnification of deformations becomes obvious. This result shows also the huge influence of choosing the right reference moisture conditions, i.e., the conditions belonging to the undeformed, unswollen volume model at the beginning. The second and third case are finally situated in the same climate, but the deformations are completely different. The analysis of stresses and strains identified large deformation in the third configuration due to the applied climate change as result of swelling- and plastic strains in the frame-system. It does not represent the deformation

quantitatively, since there is an over-estimation by regarding a constant maximum m -distribution throughout the whole volume, which would never be reached during a thunderstorm. On the other hand, some effects due to brittle failure (see Section 2.2.3), as well as stress concentrations with m -gradient by transport processes (see Section 2.3) and creeping (long-term behaviour) are not captured in this model problem. Nevertheless, the influence of moisture on the load-bearing behaviour becomes obvious. Further results are published in [24]. The application of this approach to critical construction details, such as the joints of the piano, or to the entire structure can identify the failure potential or, in terms of a long-term simulation, the development of creep deformations.

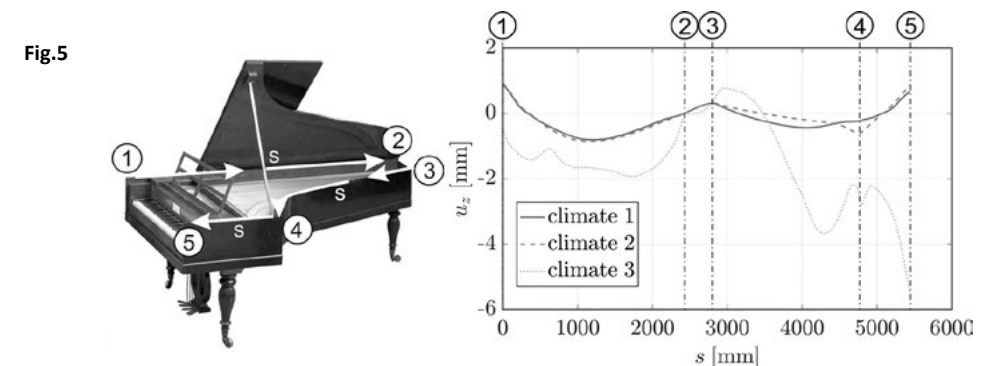
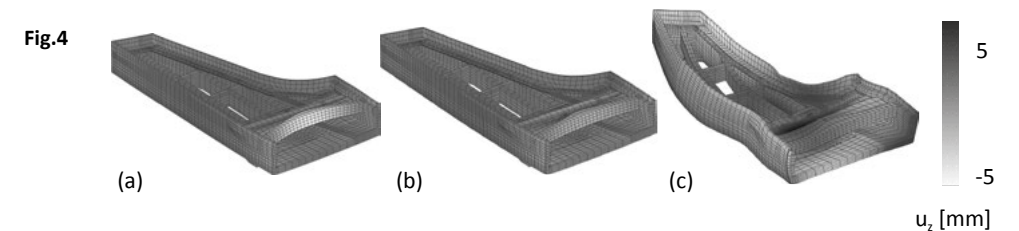

2.2.3 Plastic and brittle failure of a pianoforte

To illustrate the potential failure mechanisms at hygro-mechanical loading, a heavily-loaded detail of the pianoforte was investigated (e.g., [26]). The pin block of a keyboard instrument has to take up the strings' tension and to transfer it to the framework of the corpus over three connections: an iron brace in the centre and the two side wall joints (see **Fig.6**). Material and element formulations are equal to those in Section 2.2.2. Additionally, the veneer layer existing between

Fig.4 *Hammerflügel* MS-44: simulated vertical deformations for three simulated climate load cases (magnified $\times 15$): (a) RH/T : 40%/18°C; (b) RH/T : 70%/28°C; (c) RH/T : 40%/18°C \rightarrow 70%/28°C.

Fig.5 *Hammerflügel* MS-44: Vertical deformations of the upper edge of the side walls along path s for three simulated climate load cases.

the upper and the lower part of the pin block is described by 16-node interface-elements and a hygro-mechanically coupled interface material model (see **Table 1**). In both element types, the four degrees of freedom, i.e., the displacements in the three material directions and the wood moisture, are considered. For the bulk material, a coupled multi-surface plasticity model is applied. The load of the tensioned strings on the supported pin block is characterised in Section 2.2.2. Concerning the hygric loading, the third load case with increasing moisture from 40% to 70% RH and hygro-expansion (swelling), is applied.

Fig.6

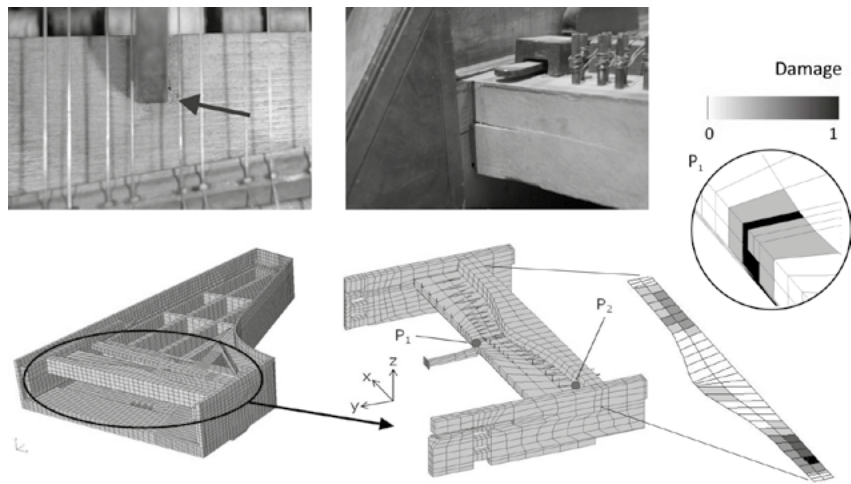

In **Fig.6**, two details of the original damaged pin block are shown. The simulated detail at point P_1 shows the plasticised wood due to the iron brace, which provokes a strong pressure perpendicular to the fibre direction of the wood. The veneer layer of the pin block is cracked on the bass side, where the loading due to string tension is extremely high (P_2). The damaged parts of the interface coincide with the areas of damage observed in the real instrument.

2.3 Analysis of a Historic Clavichord – Quasi-Static/Transient Wood Material Properties

Within this second example of a clavichord by C.G. Sauer (1807) [**Fig.7**], the effects of additional time-dependent, i.e., transient moisture transport through the volume shall be considered and analysed. As could

Fig.6 Hammerflügel MS-44: Damage in the pin block caused by local overstraining with local plasticisations around the iron brace (P_1) and cracks near lateral support on the bass side (P_2).

Fig.7

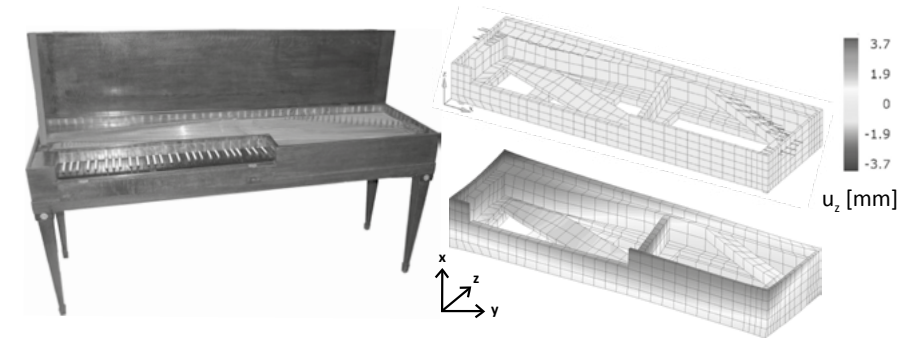
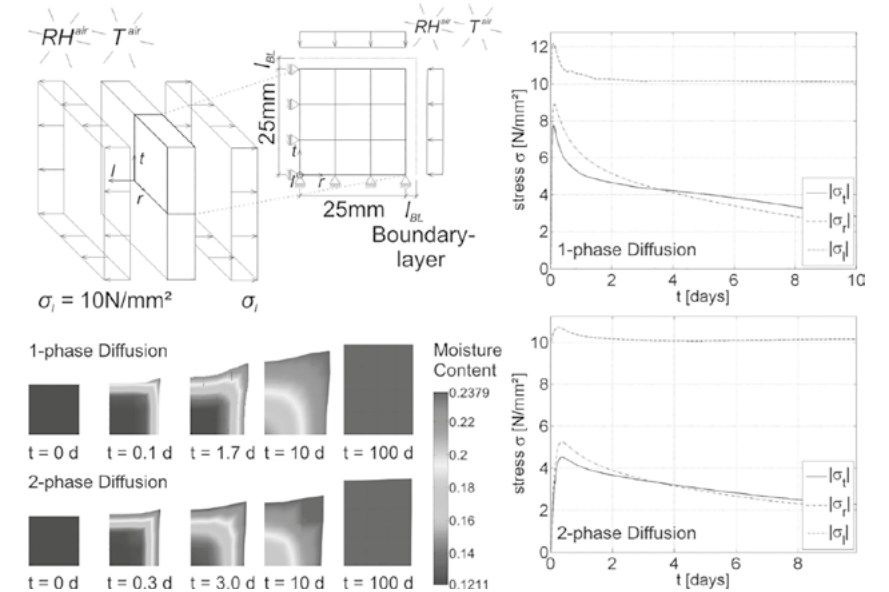

Fig.8



be seen in Section 2.2.2, the m -dependent hygro-expansion leads to massive volume changes with different quantities in the three material directions, or may lead to external constraints due to connected structural elements. Another issue now is the path from the initial state to a new equilibrium over time. Due to the non-equilibrium of m over the volume, additional internal constraints occur, caused by the m -gradient and the anisotropic shrinkage values.

Fig.7 Clavichord MS-85 (C.G. Sauer, Dresden, 1807; Stiftung Händel-Haus, Halle) and simulation results of the vertical displacements with pure mechanical loading of the tensioned strings at the beginning ($t = 0d$) and after climate changes ($t = 18d$) (see **Fig.9**).

Fig.8 Comparison of the hygro-mechanical structural response of a clear spruce wood sample to increasing relative humidity, from 65% RH to 95% RH, with two different transient diffusion models.

2.3.1 Time- and moisture-dependent material models

In contrast to dynamic behaviour, the quasi-static, transient behaviour is characterised by mass-independent and acceleration-free processes of the macroscopic structure with unsteady changes over large time scales. As listed in **Table 1**, there are the mechanical transient models, i.e., all creep issues, and the climate-dependent behaviour. Additional descriptions of creep features and viscous material models for wood can be found in [e.g., 17, 27, 28].

An example, which might be a cross-section of a clavichord wrestplank, shall illustrate the influence of transient moisture transport processes on the mechanical response. The square cross-section, visualised in **Fig.8**, is loaded in longitudinal material direction by $\sigma_l = 10\text{N/mm}^2$. The surrounding air humidity *RH* increases from 65% to 95%. Surface-elements on the sides describe the surface emission, i.e., the humidity exchange between the solid body and the environment with a boundary layer model. The diffusion through the material is modelled by two approaches. Due to the cellular micro-structure of the material with interconnected lumens (air-filled cells) and the cell walls, two parallel diffusion processes can be assumed below the fibre saturation area. The 1-phase approach only considers the bound water in the cell walls, while the 2-phase approach comes closer to reality. A three-parameter sorption model for the balance between the wood's *m* and the air's *RH* is applied. The diffusion of all phases is based on Fick's second law.

For both approaches, the distortion and moisture distribution inside the cross-section between the two equilibrium states at the beginning and after 100 days for selected relevant times are visible. Due to the anisotropic swelling in *r* and *t*, strains are constrained leading to stress concentrations. The 1-phase approach leads to significant higher stresses, especially in the critical directions *r* and *t*, whereas the latter shows smaller, but relevant peaks.

Both diffusion approaches are taken into account here, since the 1-phase approach is still state-of-the-art for the transient diffusion simulation, which might be acceptable for only small and slow humidity changes. Nevertheless, the authors propose the application of a multi-phase, or multi-Fickian diffusion model to simulate transient diffusion processes.

2.3.2 Transient analysis of a clavichord at cyclic climate load

The analysis is based on a long-term experiment on clavichord replicates [22] with large climate variations. The constant mechanical string forces corresponding to the historic tune are applied at the pin and wrest pin positions in the horizontal plane. Due to the geometrical discretisation by finite elements, the load is distributed to the elements' corner nodes. The climate load is defined by the relative humidity of the ambient air inside the climate chamber. The measured mean values are

applied, with 78% *RH* and 30% *RH* for the wet and dry cycles, respectively, starting with an initial room climate of 50% *RH*.

The clavichord's wooden load-bearing structure is very complex. The structural parts include different species with different hygro-mechanical characteristics and fibre orientations, namely spruce (side-walls and bottom, dry density $\rho_0 = 0,38\text{kg/m}^3$), beech (wrestplank, $\rho_0 = 0,65\text{kg/m}^3$) and oak (hitchpin rail, $\rho_0 = 0,65\text{kg/m}^3$). Due to the unknown exact material directions, a Cartesian coordinate system is applied for the anisotropic material directions. The fibre direction (local longitudinal material direction) is assumed to be in the length direction of the structural parts, and the tangential material direction is simply assumed to be in the vertical direction for all parts. Further simplifications are applied to the structural model. To reduce the numerical effort, the oak veneer and the balance rail have not been considered thus far. The glued joints are assumed as planar and force-fitted wood to wood connections, without any further diffusion resistance (see Section 2.3.3).

The previously introduced material models for elastic and failure behaviour with respect to moisture dependency are applied. Compressively loaded wood, especially perpendicular to the grain, leads to ductile failure with plastic deformations beyond the elastic range, modelled by a multi-surface plasticity model (see **Table 1**). The moisture transport plays an important role in the analysis of transient processes, i.e., climate changes. The transfer at the surface is captured by a boundary layer model, while the inner transport is characterised by a multi-Fickian diffusion approach. A simpler and commonly used single-phase diffusion model is found to be not accurate enough (see Section 2.3.1). The two phases of bound water in the cell walls and the water vapour in the lumens are coupled via a sorption isotherm, without considering hysteresis.

The simulated deformed structure for the pure mechanical string tension load and at the end of the three cycles (see **Fig.9**) is presented on the right-hand side in **Fig.7**. Next to the influences of changing *m*-dependent material parameters, such as stiffness and strength, and the external hygro-expansional constraints of swelling and shrinking in Section 2.2, stress peaks at every climate change due to internal constraints are influencing the structural behaviour (see **Fig.8**). Due to the transient simulation, it is now possible to investigate the continuous development versus time. The simulation can give an insight into the process of time-dependent stress peaks due to internal constraints, caused by the anisotropic swelling and shrinking behaviour of wood. Thus, the ductile failure inside the instrument over time can be analysed by **Fig.9**. The wood material plasticises when the material's compression strength is exceeded. However, the strength is dependent on moisture content and decreases with increasing moisture. A strong increase in

the number of plasticised points directly after each climate change can be observed at high and low climate conditions. The total FE structure in **Fig.9** shows the degree of single elements plasticisation after each of the three climate changes (from top to bottom). With a higher resolution of cross-sections (1) and (2), the plasticised points can be seen near the surface, especially along the edges, or near the core. Further critical areas are the joints of the structural parts. This is concurrent with other publications, e.g., [19, 24], where plasticisation is identified as a consequence of moisture-change. On the one hand, due to the anisotropic hygro-expansion, i.e., swelling and shrinking, internal constraints occur in multi-dimensionally loaded areas. In this case, the local moisture-gradient $\partial m/\partial x$ is a significant factor, depending on the velocity of moisture change inside the wooden material. On the other hand, connected structural parts, especially in case of parts with different wood species or fibre orientations, prescribe external constraints. Both may lead to material or structural failure.

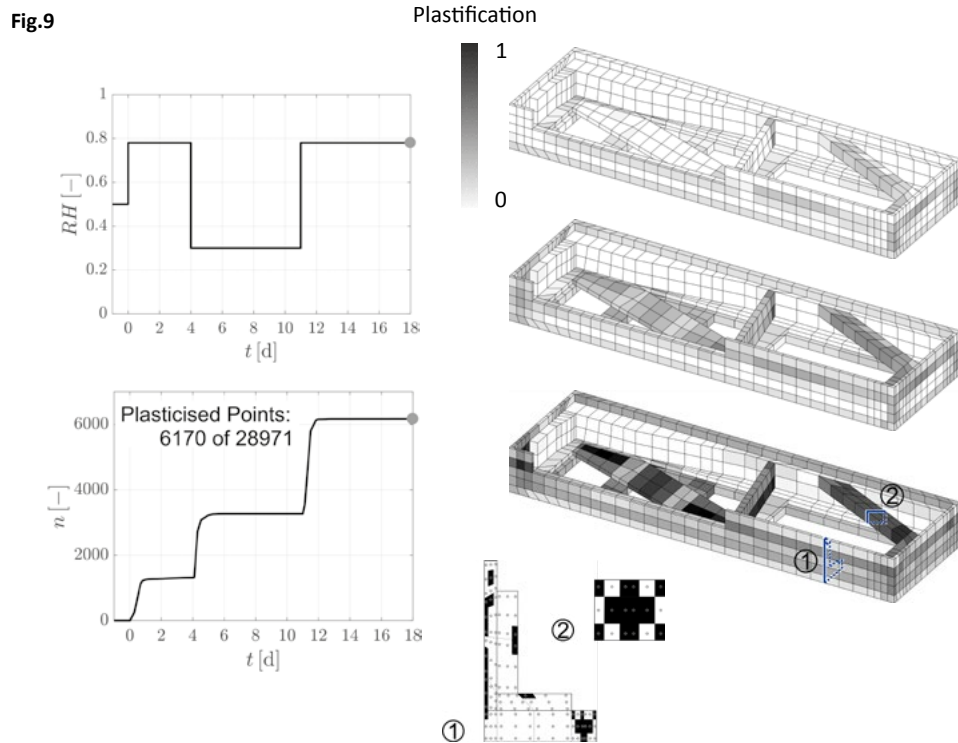

Fig.9 External climate loading $RH(t)$, number of plasticised integration points $n(t)$ and degrees of plasticisation of the structures elements at the end of each cycle (from top to bottom) with the plasticised cross-sections of side wall ① and wrestplank ② after 18 days.

2.3.3 Bondlines, veneer and varnish layers

Another numerical example investigates the cross-section of the clavichord's side wall **Fig.10** and illustrates the influence of modelled moisture barriers, such as coatings and bondlines, on transient hygro-mechanical simulation. The side wall consists of two parallel spruce boards in the lower part and just one in the upper part bonded with typical historical gelatine based glue. The outer surfaces are veneered with a 2.1 mm oak layer and additionally varnished with shellac. The two cross-sections shown in **Fig.10** form the basis for this numerical analysis since both section thickness and the number of bondlines will affect the internal moisture state. The relative humidity is changing from its initial value $RH_0 = 65\%$ to a weekly alternating climate with a rather academic amplitude of $RH_{wet}/RH_{dry} = [80\%;30\%]$, corresponding to the climate changes in Section 2.3.2. Two configurations—with and without a 0.2 mm shellac coating—are investigated.

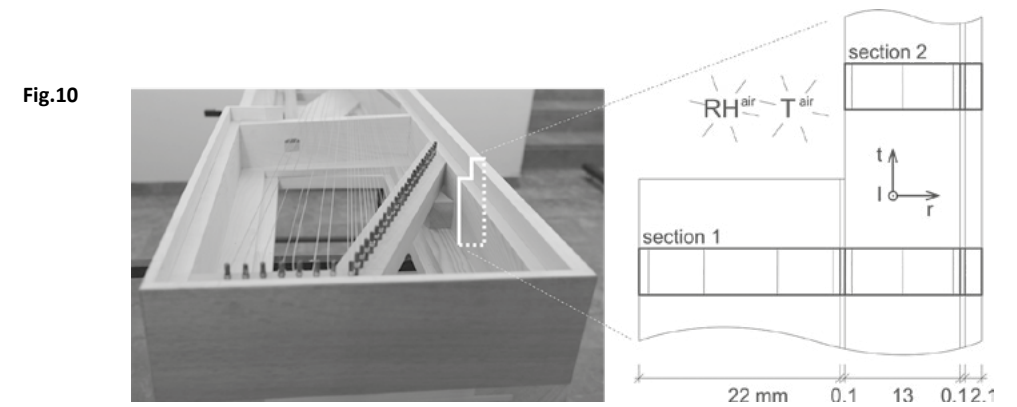

Fig.10

The influence of thickness and varnishing on the moisture distribution for the analysed climate period becomes clear. As obvious in **Table 2**, the extrema at the surfaces are quite similar for both sections, whereas the amplitudes at the centre in the compared sections differ. The veneer layer is strongly exposed to the surrounding climate. The neighbouring bondline retards the diffusion very strongly, which leads to a concentration of moisture inside the oak veneer when moisture increases, but limits it in the centre. Even the non-symmetrically applied one-sided veneer has a remarkable influence on the inner amplitude of the moisture. Applying the shellac coating as published in [20], no significant change of internal moisture content becomes visible.

Fig.10 Two discretised cross-sections of the clavichord's side wall.

Although the veneer layer is not a load-bearing part of the structure, together with the bondline, it influences the water uptake decisively. Due to short-term swelling or shrinking, the internal constraints could lead to plastic deformations of the veneer. Depending on the quality of the bondline, these internal stresses could be transferred into the load-bearing inner layers, because of the huge moisture step between the veneer layer and the spruce board. Furthermore, in case of local failure of the bondline, such as cracking due to tension or shearing, thin veneer layers are expected to kink, which would represent a well-known form of damage to historical wooden objects in museum collections.

Table 2

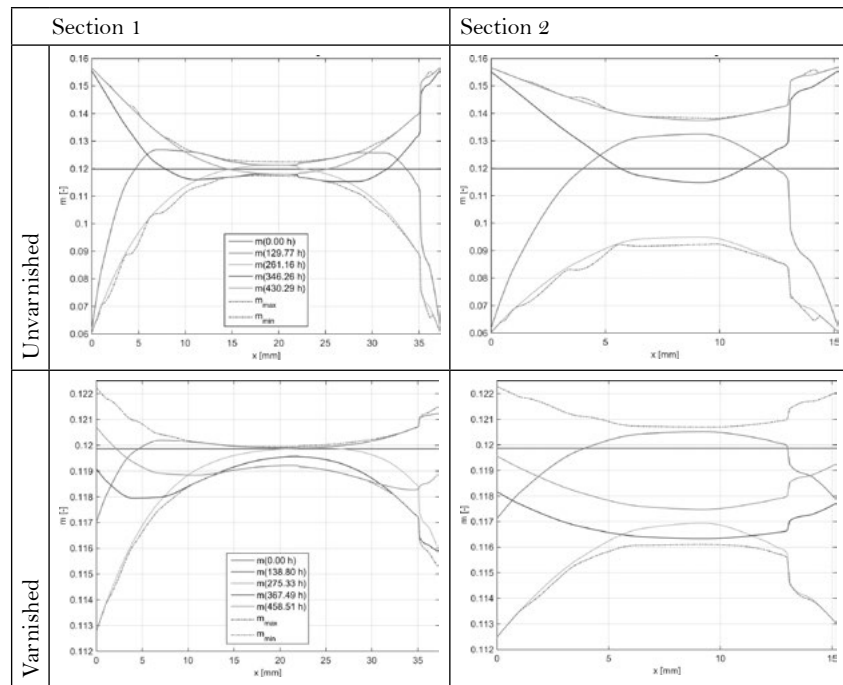

The massive differences in the varnished versions compared to those without were predictable. For both cases, the quantitative accuracy of the results cannot be proved so far. Numerous influences could increase or decrease the water uptake, such as cracked or otherwise damaged or deteriorated old varnish. Missing knowledge about its real absolute thickness and local variation increase the uncertainty. Thus, further experimental investigations towards the diffusion behaviour

Table 2 Simulated moisture $m(x, t)$ for selected times for the cross-section in Fig.10, without and with shellac coating (cyclic climate load $RH_{wet} / RH_{dry} = [80\%; 30\%]$, period $\tau = 2$ weeks).

of new and aged historical coatings are in progress (e.g., [29]). By considering the mechanical behaviour of bondlines with interface-elements (see Section 2.2.3) and the diffusion characteristics, the simulation of the transient structural load-bearing behaviour can be improved. Nevertheless, the obtained results provide insight into the principle mechanisms of diffusion behaviour in these composite structures.

Conclusions

Two historical wooden musical instruments are the focus of this introduction to structural load-bearing analysis by FEM as one important tool for the non-invasive and prognostic structural analysis. The basics of numerical and material modelling are given herein, and the potential of a comprehensive numerical analysis tool are pointed out. A categorisation of material characteristics is presented and the effects of the consideration of material models for the static material behaviour on the structural load-bearing behaviour are presented step by step.

Current research at the Institute for Structural Analysis aims to consider bondlines and material inhomogeneities due to natural variation and long-term behaviour, such as creep in the modelling on a structural scale. Further experiments in the material parameter characterisation, especially in the long-term behaviour and the moisture dependency, would support the quality of the simulation. However, the first step to an objective, general and non-destructive assessment tool for cultural wooden heritage, accounting for the multi-physical nature of wood, has been carried out and successfully applied to the load-bearing FE-analysis of wooden musical instruments.

ACKNOWLEDGEMENTS: The authors acknowledge the scientific cooperation with the Institute for Building Materials of ETH Zurich under the former chair Peter Niemz and research assistant Erik Bachtar. Special thanks to Clemens Birnbaum and the conservators at Stiftung Händel-Haus, Halle, Stefan Ehrlich, Achim Haufe and Roland Hentzschel, for the fruitful cooperation and experimental support.

The financial support of the work by the German Research Foundation (DFG) within project KA 1163/25 "Modelling and Characterization of the Structural Behaviour of Wooden Cultural Heritage under Hygro-mechanical Loading" is gratefully acknowledged.

References

- [1] O. Allegretti, P. Dionisi-Vici, J. Bontadi and F. Raffaelli, "The case study of The daughters of the Emperor Ferdinand I by Jakob Seisenegger, in Trento (Italy): analytical hygro-mechanical results as a support in risk assessment for technical interventions," *Applied Physics A*, vol. 123, Ch. 38, 2016.
- [2] J. Froidevaux, "Wood and paint layers aging and risk analysis of ancient panel painting," Ph.D. dissertation, Université Montpellier II, 2012.
- [3] L. Krzemień, M. Łukomski, Ł. Bratasz, R. Kozłowski and M. F. Mecklenburg, "Mechanism of craquelure pattern formation on panel paintings," *Studies in Conservation*, vol. 61, pp. 324–330, 2016.
- [4] B. Marcon *et al.* "Mechanical study of a support system for cupping control of panel paintings combining crossbars and springs," *Journal of Cultural Heritage*, vol. 13S, pp. S109–S117, 2012.
- [5] B. Rachwał, Ł. Bratasz, M. Łukomski and R. Kozłowski, "Response of wood supports in panel paintings subjected to changing climate conditions," *Strain*, vol. 48, pp. 366–374, 2012.
- [6] B. Buchelt, T. Dietrich, A. Wagenführ, M. Danczak and J. Jaschinski, "Shape alteration of large string instruments due to changing climate conditions," *European Journal of Wood and Wood Products*, vol. 75, pp. 561–567, 2017.
- [7] M. Fioravanti, G. Goli and B. Carlson, "Viscoelastic and mechano-sorptive studies applied to the conservation of historical violins: A case study of the Guarneri 'del Gesù' violin (1743) known as the 'Cannone,'" *Journal of Cultural Heritage*, vol. 14, pp. 297–303, 2014.
- [8] G. Goli *et al.*, "Antique violins: effect of the player on the moisture content," *Int. Journal of Conservation Science*, vol. 8, pp. 177–186, 2017.
- [9] S. Le Conte, S. Le Moyne, F. Ollivier and S. Vaiedelich, "Using mechanical modelling and experimentation for the conservation of musical instruments," *Journal of Cultural Heritage*, vol. 13S, pp. S161–S164, 2012.
- [10] S. Kirsch, *et al.*, "The MUSICES-Project: Towards a standard for 3D-computed tomography of musical instruments," in M. Kaliske, D. Konopka, P. Niemz, C. Birnbaum and K. Anheuser, Eds., *Analysis and Characterisation of Wooden Cultural Heritage by Scientific Engineering Methods*. Dresden: Technische Universität Dresden, 2016, pp. 131–140.
- [11] M. A. Pérez, A. Manjón, J. Ray, R. Serra-López, "Experimental assessment of the effect of an eventual non-invasive intervention on a Torres guitar through vibration testing," *Journal of Cultural Heritage*, vol. 27, pp. S103–S111, 2017.
- [12] M. A. Pérez, P. Poletti and L. G. Espert, "Vibration testing for the evaluation of the effects of moisture content on the in-plane elastic constants of wood used in musical instruments," in C. M. A. Vasques and J. D. Rodrigues, Eds., *Vibration and Structural Acoustics Analysis*. Dordrecht: Springer, 2011, pp. 21–57.
- [13] N. Sodini *et al.*, "Non-invasive microstructural analysis of bowed stringed instruments with synchrotron radiation X-ray microtomography," *Journal of Cultural Heritage*, vol. 13S, pp. S44–S49, 2012.
- [14] R. Viala, V. Placet and S. Cogan, *Mixed Geometrical-Material Screening Analysis for the Study of Complex Phenomena in Musical Acoustics*, Ch. 38, Cham: Springer, 2017, pp. 371–374.
- [15] R. Afshar, N. van Dijk, I. Bjurhager and E. Gamstedt, "Comparison of Experimental testing and finite element modelling of a replica of a section of the Vasa warship to identify the behaviour of structural joints," *Engineering Structures*, vol. 147, pp. 62–76, 2017.
- [16] N. van Dijk, E. Gamstedt and I. Bjurhager, "Monitoring archaeological wooden structures: Non-contact measurement systems and interpretation as average strain fields," *Journal of Cultural Heritage*, vol. 17, pp. 102–113, 2012.
- [17] D. Konopka, C. Gebhardt and M. Kaliske, "Numerical modelling of wooden structures," *Journal of Cultural Heritage*, vol. 27, Suppl., pp. S93–S102, 2017.
- [18] A. Patera, H. Derluyn, D. Derome and J. Carmeliet, "Influence of sorption hysteresis on moisture transport in wood," *Wood Science and Technology*, vol. 50, pp. 259–283, 2016.
- [19] D. Konopka and M. Kaliske, "Transient multi-Fickian hygro-mechanical analysis of wood," *Computers and Structures*, vol. 197, pp. 12–27, 2018.
- [20] S. Reichel, "Modellierung und Simulation hygro-mechanisch beanspruchter Strukturen aus Holz im Kurz- und Langzeitbereich," Ph.D. dissertation, Technische Universität Dresden, 2015.
- [21] C. Gebhardt, D. Konopka, A. Börner, M. Mäder and M. Kaliske, "Hygro-mechanical numerical investigations of a wooden panel painting from 'Katharinenaltar' by Lucas Cranach the Elder," *Journal of Cultural Heritage*, vol. 29, pp. 1–9, 2018.
- [22] Konopka, D.; Ehrlich, S.; Kaliske, M.: Hygro-mechanical Investigations of Clavichord Replica at Cyclic Climate Load: Experiments and Simulations, *Journal of Cultural Heritage*, <https://doi.org/10.1016/j.culher.2018.07.006> (2018).
- [23] D. Konopka and M. Kaliske, "Hygro-mechanical structural analysis of keyboard instruments," in M. Kaliske, D. Konopka, P. Niemz, C. Birnbaum and K. Anheuser, Eds., *Analysis and Characterisation of Wooden Cultural Heritage by Scientific Engineering Methods*. Dresden: Technische Universität Dresden, 2016, pp. 63–76.
- [24] S. Saft and M. Kaliske, "Computational approach towards structural investigations for the restoration of historical keyboard instruments," *Journal of Cultural Heritage*, vol. 13S, pp. S165–S174, 2012.
- [25] P. Niemz, *Physik des Holzes und der Holzwerkstoffe*. Leinfelden-Echterdingen: DRW-Verlag, 1993.
- [26] M. Kaliske and S. Saft, "Static structural analysis of historical keyboard instruments," in C. Birnbaum, S. Ehrlich, M. Kaliske and S. Saft, Eds., *Analysis and Description of Music Instruments Using Engineering Methods*. Halle/Saale: Verlag Stiftung Händel-Haus, 2011.
- [27] S. Reichel and M. Kaliske, "Hygro-mechanically coupled modelling of creep in wooden structures, Part I: Mechanics," *Int. Journal of Solids and Structures*, vol. 77, pp. 28–44, 2015.
- [28] S. Reichel and M. Kaliske, "Hygro-mechanically coupled modelling of creep in wooden structures, Part II: Influence of moisture content," *Int. Journal of Solids and Structures*, vol. 77, pp. 45–64, 2015.
- [29] S. L. Lämmlein, D. Mannes, F. W. M. Schwarze, I. Burgert and M. S. Gilani, *Combined Experimental and Numerical Investigation of Vibro-Mechanical Properties of Varnished Wood for Stringed Instruments*, Ch. 9. Cham: Springer, 2017, pp. 81–83.

Restoration of the Mother-and-Child Virginal by Ioannes Ruckers (Antwerp, 1610): *The Choice of a New Presentation With a Focus on the Difficult Problem of Soundboard Cleaning*

AGNÈS ESQUIROL (1), LIVINE HUART (1), CÉCILE DE BOULARD (2)

(1) Conservator, Musical Instruments Museum, Brussels, Belgium

(2) Conservator of Paintings, Brussels, Belgium

Abstract

Through the ages, the two parts of the mother-and-child virginal preserved at the Brussels Musical Instruments Museum (MIM, inv. 0275) have not undergone the same modifications. One of the principal goals of the restoration project was to present the mother-and-child virginal as effectively as possible while respecting the separate histories of previous changes made to both parts. Particular care was taken with the cleaning of the soundboards. On one hand, water was required to remove soiling; on the other hand, it is well known that the soundboard surface is very sensitive to water. We were obliged to explore systems with very limited volumes of water, such as fat emulsions and rigid gels.

Introduction

This article is about the restoration of the mother-and-child virginal made in 1610 by Ioannes Ruckers (1578-1642) and is conserved at the MIM (inv. 0275). The instrument comes from the collection of the Belgian musicologist François-Joseph Fétis (1784-1871) who was the first director of the Royal Conservatory of Brussels. Purchased in 1872 by the Belgian government, it was first stored in the premises of the Conservatory. Five years later, it was transferred to the newly created Musical Instruments Museum [1]. In 2017, the “double virginal” was restored at the MIM restoration workshop, after a comparative study of the 18 Ruckers harpsichords and virginals within the museum’s collection, initiated and conducted by Pascale Vandervellen, keyboard instrument curator. This project was primarily sponsored by the Baillet-Latour Fund.

In the first part of the article, the double virginal will be contextualised by discussing its playing characteristics, pointing out the singularity of the Ruckers dynasty and placing it among the other preserved mother-and-child virginals. Modifications made throughout the ages will also be explained. Subsequently, the Ruckers standards of virginal decoration will be described and compared with Ioannes Ruckers’ double virginal. The successive layers of decoration will then be examined, followed by an explanation of the kind of restoration we chose for this instrument. Finally, the cleaning treatment done on the soundboards will be presented. The very sensitive painted decor offered the opportunity to explore several specific cleaning techniques using recent methods.

Fig.1



Fig.1 The instrument before treatment. MIM inv. 0275 © Photo Simon Egan.

Playing the Mother-and-Child Virginal

This double virginal consists of a six-foot-long virginal, called the mother, with a smaller three-foot-long virginal, called the child. Originally, the child was stored inside the case of the mother, but both instruments could be played separately: the child could either be completely removed from the mother or slightly pulled out [2]. Another possibility was simultaneous playing of both virginals by placing the child on the soundboard of the mother. In that case, the musician who played the mother simultaneously led the playing of the child; an opening in the baseboard of the child allows the mother’s jacks to activate the child’s jacks.

The Ruckers Dynasty

Ioannes Ruckers belongs to the second generation of the most famous harpsichord makers family in Antwerp from 1580 to 1680. His father Hans (c.1550-1598) started building harpsichords in 1579, at a time when Antwerp was one of the highest esteemed hubs for harpsichord making in Europe and abroad [3].

Following the death of Hans in 1598, Ioannes worked in his father’s workshop in Jodenstraat, Antwerp, together with his younger brother Andreas (1579-c.1652) until 1608, when he took over as head of the family workshop. Two years later, in 1610, Ioannes built this mother-and-child virginal. The family rose he placed in the soundboard still held the initials of the father, Hans Ruckers [4].

Preserved Mother-and-Child Virginals

Today, about a hundred Ruckers instruments are preserved worldwide, more than a fourth of which are in Belgium. Only five complete mother-and-child virginals are preserved: one in New York at the Metropolitan Museum (inv.29.90/Hans Ruckers 1581), one in New Haven at the Yale University (inv.4870.60/Hans Ruckers 1591), one in Milan at the Castello Sforzesco (ST.MUS.n.595/Ioannes Ruckers c.1600), one in Stuttgart at the Württembergisches Landesmuseum (inv.?./Ioannes Ruckers 1623) and the one at the MIM in Brussels.

The serial numbers inside the mother and child parts of the Brussels instrument confirm that they belong together. Serial number 23 is found on both pieces, indicating that it is the twenty-third mother-and-child instrument produced by Ioannes Ruckers. Several key levers are numerated with the initial “m” used for “moeder” (mother) and “k” for “kind” (child). For example, 1/k/23 is written on the first jack of the child instrument with serial number 23.

Fig.2

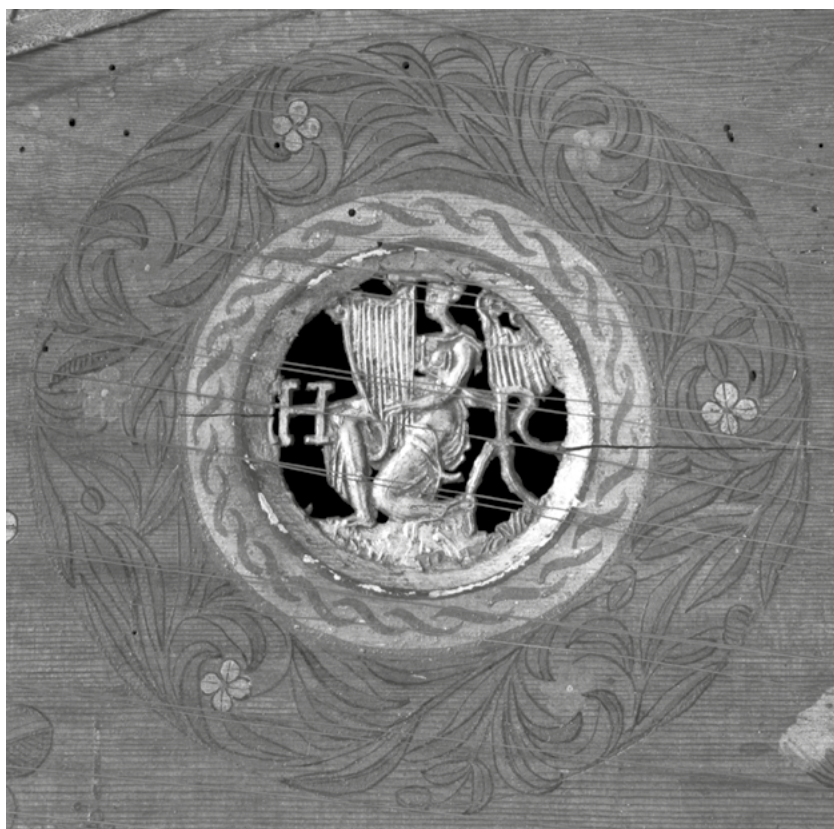

Fig.3



Modifications to the Brussels Mother and Child

Both the mother and child of the MIM instrument have received structural and decorative modifications since the seventeenth century. Most significantly, they underwent *ravalement*—a French term because this operation was mostly used in France, where they preferred to transform highly-esteemed Flemish virginals and harpsichords into up-to-date

Fig.2 Rose with surrounding decoration. MIM inv. 0275 © Photo Simon Egan.

Fig.3 Child release in progress. MIM inv. 0275 © Photo Simon Egan.

instruments meeting the then-current playing standards, rather than discarding them. The main goal was to extend the compass, which, among other things, involved an enlarging the key well, adding keys, strings and jacks, and adapting the bridges. In this case, the keyboards of the mother and child were expanded with four additional notes (keys) in the bass and five in the treble, providing a compass of four and a half octaves instead of the original four. However, extending the mother keyboard and sealing the front panel meant the child could no longer be inserted in the mother. Many other elements have been added or replaced on the mother, such as the mouldings and the feet, while other elements have disappeared, including the lid, the fallboard and the jackrail.

Decoration

In the seventeenth century, the decoration of Ruckers instruments became standardized to a model type that remained quite stable until the decline of the Ruckers production. This model of decoration corresponded to a logic of economy of time and means, while giving the illusion of an elaborate and expensive decoration [5].

The *outside* of the virginals was usually decorated to imitate the appearance of marble. The virginals were probably all painted in a dull green spotted with off-white to imitate the effect of porphyry marble [6]. Analyses on the eleven Ruckers virginals within the MIM collection have identified this type of decor. Under binocular examination, green porphyry has been observed on the back of the mother case, as the original decoration beneath later repainting. But on the sides of the case, this original layer is no longer present.

The *inside* of the case and key well was covered with black and white printed paper in various standard designs. These papers were much cheaper to produce than the hand-painted case patterns of the Hans Ruckers' virginal dating from the sixteenth century [7]. On the mother, the printed papers on the key well and on the inner case sides above the soundboard are covered by later repainting, but those on the face board are no longer visible because of the shutdown of the front panel in which the child used to be stored. The child has retained all its printed papers on the case and around the soundboard, although concealed by later repainting.

Thorough examination confirms that despite the very dark look, the *soundboards* of both the mother and child were painted with flowers, fruits, insects and birds. Close to the bridges and the edges is a scalloped border interrupted by elaborate arabesques in blue paint. XRF measurements of the painted decoration of the mother and child soundboards confirm that the pigments correspond well to the classic palette used in the early seventeenth century [8].

The *rose*, the builder's trademark or sign, was the centre of the soundboard decoration. It is emphasized with a surrounding red and white painted ring of geometric motifs; around this ring there is a stylized wreath of flowers or leaves [Fig.2].

The *mouldings* were left in bare, pale poplar. Coated in glossy varnish and surrounded by non-reflective paint and paper, they appear gilded. The mother no longer has its original mouldings and the child's mouldings were completely over-painted in the dark layer.

Examination of the state of both instruments' decoration confirmed that their original decoration corresponded faithfully to the standards of Ruckers.

Successive Layers of Decoration on Mother and Child

Chemical analysis and analysing the data collected during examination of both the mother and the child made it possible to establish the successive layers of decoration applied to the instrument over the original decoration. On the outside of the mother case, four different decors were clearly distinguished over the original, by studying cross-sections [8, p.338-339]. A release window located on the spine of the mother case (see Fig.4) shows the different interventions: the original layer is the green porphyry (1), the first overpainting is a dark green layer (2), the second one is grey (3, 4), and the two latest overpaintings are *faux-bois* (mahogany) (5, 6) (7, 8). Inside the mother, on the key well and around the soundboard, the printed papers were successively covered by blue overpainting and the two latest layers of *faux-bois*. The decoration of the first *faux-bois* dates from the *ravalement*, since the enlarged nameboard features only this first *faux-bois*.

The successive layers of the decor on the child case are more difficult to identify and give way to different interpretations: while chemical analysis experts detect several successive interventions, according to our own interpretation, from a technological point of view, the child case presents only one decor consisting of several layers following the original [9]. In our eyes, the only overpainting was a Prussian blue enhanced with a gilded band. The same blue is found on the inside of the mother beneath the *faux-bois*, indicating that the child's overpainting is older than the mother's current decoration and that it precedes the instrument's *ravalement*.

The Restoration

Within the time frame and financial limits of the research, we were only able to research other preserved double virginals through written sources. Articles on the double virginals in New York, Milan and Stuttgart

Fig.4



reveal that the original printed paper decor has been retained on both the mother and the child. In the instrument preserved in New Haven, both the mother and child have the same overpainted decor. However, the main feature that sets the mother-and-child virginal at the MIM apart from all the others is that its front is closed and can no longer accommodate the child. During the cleaning process, it became clear the child remained on top of the mother, as the decor on the mother within the space occupied by the child is much better preserved. Undoubtedly the child continued to be played. This dissociation between the mother and child is unique to the MIM instrument and has not been found on the other preserved double virginals. It seems that the separation of the two also led to a different decoration history between the Brussels mother and the child.

Fig.4 A release window on the mother. MIM inv. 0275 © Photo Simon Egan.

In order to preserve as much information as possible on the instrument's long history while also showing the public as much as possible the original splendour of the Ruckers virginals, we opted for the restoration treatment described hereafter. As said before, over the history of double virginal inv. 0275, the mother underwent various changes, both structural and decorative. The child, however, was changed only once. Not having the same history, we chose to treat the decorations of both parts differently.

For the mother, it was decided to keep all underlying decorations and to restore the latest faux-bois. Returning to an earlier stratum was considered unacceptable since it would result in the loss of an important part of its history. The successive layers of decoration preserved under the overpainting are visible through the release windows: on the outside, one can see the four successive overpaintings, down to the original layer, the green porphyry [Fig.5]; on the interior case sides and on the key well, windows are opened to reveal the patterns of the printed paper.

As for the child, considering the low aesthetic value of the current overpainting, it was decided to return to the original decor, which, thanks to our observation under binocular, we knew was very well preserved. The overpainted layer that was removed matched the second layer of decoration on the inside of the mother, where it is still present. We also kept a witness on the child case (about 2cm wide).

This treatment allowed the double virginal to preserve traces of its history while revealing the beauty of its original decoration. Given the singularity of this decision, it is recommended to present the virginal with an explanation ensuring a fair reading of this presentation.

Fig.5



Treatment: A focus on Soundboard Cleaning

Whereas the structural condition of the double virginal was quite good, aesthetically it was in a bad state. Therefore, the main treatment chal-

Fig.5 The mother and child after treatment. MIM inv. 0275 © Photo Atelier.

lenge was to clean the mother and child soundboards. Indeed, both surfaces were so dirty that it was not possible to admire their painted decors.

The painting is rather matte and thick. Its binding agent could not be identified because too much original material is required for analysis. However, the appearance of the painting, the water sensitivity of the decors and especially the literary sources strongly suggest that the painting's medium is gum Arabic [10] or possibly an emulsion gum/oil [11].

Both soundboards suffered from many abrasions, areas of water damage, projections, stains and previous restoration interventions. However, the main problem was the pronounced dirt incrustated in and under the non-original varnish and in the aged surface that had become porous. Furthermore, the presence of this varnish denatures the aesthetic aspect of soundboards that were originally unvarnished.

The first step in the cleaning process was to remove the non-original varnish. This operation was carried out easily with organic solvents (a 50/50 mix of Ethanol / Shellsol D40) [12]. The dissolution of the varnish allowed us to remove a fair amount of the dirt incrustated underneath it. However, the result was not satisfactory because the surface was marked by large water stains and lacked clarity and contrast. In order to remove more dirt would require a water supply, which would cause a reaction in the painted decor and the wood surface: the spruce would swell and the painted medium would be sensitive to water. As paint is more water-sensitive than water-soluble, we referred to recent studies concerning the cleaning of paintings, especially acrylics that are also characterized by sensitivity to water.

Thanks to the research of R. Wolbers [13], C. Stavroudis [14] and P. Cremonesi [15], the last twenty years have seen the emergence of cleaning methods with emulsions, agar gel, silicone gel and, through the research of Baglioni *et al.* [16], nanogels. These techniques significantly limit the amount of water used. The water is, so to speak, held in a matrix that releases it in very small doses while cleaning. Following the approach proposed by C. Canevari in *Surface Cleaning of Stringed Instruments* [17], we are convinced that aqueous methods offer rich potential for the cleaning of wood instruments.

Fat emulsions and rigid gels were tested to clean the surfaces of the mother and child. Fat emulsions are a two-phase formulation: the internal phase, water, is embedded in the external phase, oil. We tested three different types of fat emulsion: the classic formulation, in which the surfactant makes a bridge between both immiscible phases¹, and two other formulations with polymers possessing auto-emulsifying properties, Pemulen[®]TR2 and Velvesil[®] Plus. Because the external phase is directly

1 Tween 20 (4ml) was used mixed with 90% Shellsol[®] D40 and 10% water (V/V).

in contact with the surface, a safe solvent was chosen. Apolar solvents such as aliphatics were tested and found to be safe for the surface. Water, the internal phase in the form of droplets inside the apolar phase (oil phase), will have limited contact with the surface while the gel is stirred on it.

Among the three types of fat emulsions, the one made with Pemulen®TR2 produced the best results, without any bleaching after cleaning as opposed to the two others. Pemulen®TR2 is a cross-linked block copolymer of acid polyacrylic with a hydrophobic long-chain of methacrylate; it has a high emulsifying capacity. Thanks to the addition of the base Ethomeen® C12, a fat emulsion gel can be made. In this case, we used Shellsol® D40 for the oil phase and a small amount of water (10%) was added. The water is given a slightly acid pH, buffered to pH 5.5, in order to respect the wood surface and the old painting. The gel² obtained in this manner is applied on the surface of the soundboard with a cotton-tipped stick and then picked up before the surface is rinsed with heptane. This method gives excellent results and is shown to be sufficient for the less soiled areas.

In the dirtiest areas, the cleaning was enhanced thanks to the use of rigid gels. Agar agar and Nanogels were tested, and interestingly, the second type helps. The chosen gel, Nanorestore Gel® Max Dry, is transparent, ready-to-use and 2mm thick. Made of equal parts polyhydroxyethylmethacrylate—p(HEMA)—and polyvinylpyrrolidone (PVP), it holds 50% of the water captive in its nanopores. This gel, whose cohesion is based on covalent bonds presenting no danger of residues, has been chosen for its high water-holding capacity. It is applied on the surface for a duration of almost 2 minutes, releasing a very small amount of water, which allows the swollen, dry dirt to be collected. The cleaning is completed using the fat emulsion based on Pemulen®TR2 as seen above.

Fig.6



- 2 Gel formulation: 0.5g Pemulen® TR-2, 8ml Ethomeen® C12, 90ml Shellsol® D40, 10ml buffered water pH 5.5. Buffer made with 0.06% glacial acetic acid, buffered with NaOH 1M.

Fig.6 Mother soundboard's cleaning in progress. MIM inv. 0275 © Photo Simon Egan.

Cleaning was done over the entire surface of both soundboards, continuously checking the equilibrium between both instruments. This operation highlights the reading of the decor and brings out the aesthetic value of the double virginal.

To finish the treatment of the soundboards' decorative paintings, some retouching was done, and a thin layer of Klucel®G 3% in ethanol was applied by brush to protect the surfaces against future fouling.

Fig.7



Fig.8



Conclusion

After a study of the decoration of Ioannes Ruckers' mother-and-child virginal, the restoration was an opportunity to choose a new presentation for these two instruments. Created as an inseparable pair, these two instruments experienced different physical histories over the centuries. As a result, each one has to be considered individually in terms of its own material history and possible restoration policies. The mother, having experienced a number of irreversible structural changes, could not be returned to its previous state. The child, meanwhile, had remained almost unchanged and retained the entirety of its original decor. This

Fig.7 Mother soundboard after cleaning. MIM inv. 0275 © Photo Atelier.

Fig.8 Child soundboard after cleaning. MIM inv. 0275 © Photo Atelier.

is why it was decided to reveal the original decor of the child. The restoration process was also an opportunity to focus on the delicate problem of cleaning the soundboards. Thanks to present-day research on new cleaning methods, several types of fat emulsions and rigid gels were tested. The results were satisfactory and allowed the decoration of both soundboards to be enhanced.

ACKNOWLEDGEMENTS: Our sponsors: Baillet Latour Fund, Léon and Marcelle Courtin-Bouché Fund, King Baudouin Foundation, Belgian Science Policy Office (BELSPO), COST (European Cooperation in Science and Technology), and TNT Eurohub.

Our external collaborators: Emily Akkermans & Patrick Storme (University of Antwerp), Prof. Dr Danièle Balériaux (Université Libre de Bruxelles), Christina Currie, Catherine Fondaire, Pascale Fraiture, Marina Van Bos, Ina Vanden Berghe and Armelle Weitz (Royal Institute for Cultural Heritage), Giuseppina Di Giulio and Giovanni Signorini (University of Florence), Sandie Le Conte (Cité de la Musique, Paris), Arjan Versteeg (Dendrochronology), Florence Trus (Trainee), and gratitude beyond expression for Mathieu Ndangi.

Our internal collaborators: Pascale Vandervellen, Joris De Valck, Manu Frederickx, Simon Egan, Pierre Gevaert, Stéphanie Caeymaex, Céline Bourguignon, Annelien Verbeeck, Mathieu Thonon, Saskia Willaert and Anne-Emmanuelle Ceulemans.

References

- [1] P. Vandervellen, Ed., *The Golden Age of Flemish Harpsichord Making: A Study of the MIM's Ruckers Instruments*. Brussels: MIM, 2017, p.103.
- [2] P. Vandervellen, "Catalogue of the MIM's Ruckers instruments," in [1], p.73].
- [3] For detailed accounts of the Ruckers dynasty see G. O'Brien, *Ruckers: A Harpsichord and Virginal Building Tradition*. Cambridge: Cambridge University Press, 1990; and [1].
- [4] E. Akkermans and P. Storme, "The Ruckers roses revealed: comparison of the roses on Ruckers instruments using optical analysis and XRF," in [1], p.317].
- [5] S. Germann, *Harpsichord Decoration: A Conspectus*, in H. Schott, Ed., *The Historical Harpsichord*, vol. 4. (n.p.): Pendragon Press, 2000, p.21.
- [6] G. O'Brien, "A quatercentenary celebration," *Early Music*, vol.7, no. 4, p.456, Oct. 1979.
- [7] Hans Ruckers, *Double Virginal (1581)*. New York, The Met.
- [8] S. Saverwyns and M. Van Bos, "Looking beyond the decorated Surface: A material-technical study of decorations on Ruckers instruments," in [1].
- [9] S. Saverwyns and Marina Van Bos, *Analyseverslag: Moeder en Kind–Virginal inv. 0275 – 2014.12262*, 2016.
- [10] A. and P. Mactaggart, "Some problems encountered in cleaning two harpsichords soundboards," *Studies in Conservation*, vol. 22, no. 2, p.74, May 1977.
- [11] J. P. Echard, C. Laloue, I. Chochod, and D. Pipitone, "Characterization and conservation of the decorative paint on seventeenth-century French and Flemish harpsichord soundboards," in *The International Institute for Conservation of Historic and Artistic Works*, Contribution to the Vienna Congress, 57, 2012, pp.103-113
- [12] "Report of treatment *Virginal* Ioannes Ruckers, 1610." Brussels: MIM, 2018.
- [13] R. Wolbers, *Cleaning Painted Surfaces: Aqueous Methods*. London: Archetype Publication, 2000.
- [14] C. Stavroudis, "Silicone-based solvents in conservation. As free solvents and components of gel systems and micro-emulsions," in V. Selva Bonino, Ed., in *Proc. 7th Int. Congr. Dall'olio all'acrilico, dall'impressionismo all'arte contemporanea*, Milan, 2015, p.176-185.
- [15] P. Cremonesi, *L'ambiente acquoso per la pulitura di opere policrome*. Padua: Il Prato, 2011.
- [16] P. Baglioni and D. Chelazzi, Eds., *Nanoscience for the Conservation of Works of Art* (Nanoscience & Nanotechnology Series, no. 28). Cambridge: RSC Publishing, 2013.
- [17] C. Canevari, "Surface cleaning of musical instruments," in Emanuele Marconi, Ed., *Diagnostic and Imaging on Musical Instruments*. (n.p.): Nardini Editore, 2010-2011.

FA-RE-MI (Faire parler les instruments de musique du patrimoine): *Making Historical Musical Instruments Speak*

STÉPHANE VAIEDELICH (1), H. BOUTIN (1),(2),(3),
ARTHUR PATÉ (2),(4), A. GIVOIS (2),(5), B. FABRE (2),
S. LE CONTE (1), J.-L. LECARROU (2)

(1) CRC, USR 3224-ECR Musée de la Musique,

Cité de la Musique – Philharmonie de Paris, France

(2) Sorbonne Université, CNRS, LAM/Institut d'Alembert, Paris, France

(3) Sorbonne Université, Ircam Lab, CNRS, Ministère de la Culture, Paris, France

(4) IEMN (UMR 8520 CNRS), Département ISEN, Lille, France

(5) LISPEN, Arts Et Métiers ParisTech, Lille, France

Abstract

Musical instruments can be considered objects that have been empirically optimized for centuries. Depending on geography and epoch, these optimizations have followed or boosted the evolution of music itself, as instrument-making choices, playing techniques and sound aesthetics are greatly intertwined. For preservation reasons, most of the musical instruments kept in public collections (e.g., in museums) are no longer played. In order to bring these sounds from the past back to life, facsimiles are made by contemporary makers through the study of cultural heritage instruments and their documentation (archives, paintings). Nevertheless, being able to copy an instrument does not mean being able to understand the original meaning and purpose of the instrument. In particular, some material or assembly choices and instrument-maker adjustments are not really known and, using the sample instrument, we have to infer this knowledge. A mechanical and acoustical approach applied to cultural heritage objects allows us to extract objective information by non-invasive means: in situ measurements, observations, modelling. This paper is a step towards a better understanding of the choices made by instrument-makers of the past. The multidisciplinary methodology used here (mixing acoustics, history, organology and perception) allows us to go beyond limitations due to classical descriptive approaches. The paper presents studies about plucked and woodwind instruments as separate sections, as these two instrument families exhibit different technical aspects and instrument-making decisions. As an example of the methodologies used, we consider the voicing of harpsichord plectra and the wood species of woodwind instruments.

1. Introduction

Assuming that materials used to make musical instruments are deliberately chosen by makers to meet their functional needs seems to be reasonable and is often confirmed by experience. It is also clear that the instrument-maker's turn of hand and skills are guided and limited by the needs of musical performance. For these reasons, the musical instrument is deep-rooted in the culture or cultures in which it is—or was—played, so that these material preferences and practices are closely tied to a cultural context, which natural sciences or engineering cannot justify. Thus, although a solid relationship can nowadays be established between the mechanical parameters of the wood used in instrument-making and some of its measured physical properties, the criteria for the selection of the species often escape this logic alone [1-6]. The importance of some parameters whose functional influence is not directly assessed has been highlighted for a long time. As early as 1637, Father Mersenne [7], a scholar and thinker often referred to as “father of acoustics”, did not dissociate the mechanical properties from the visual qualities of the material. In his “Universal Harmony”, he said: “To make a good flute, a good wood will have to be chosen among those which will seduce the ear and delight the eye”.

The approach of physical sciences and engineering identifies and prioritizes the physical parameters involved in the functional mechanisms of the musical instrument, as well as the musical gesture itself. Mixed with historical and musical knowledge, such results make it possible to better categorize and explain the choices in the art of making musical instruments. This multidisciplinary perspective provides the musical instrument with a broader identity, in agreement with the essential place it holds within all human societies.

The FA-RE-MI research project initiated during COST action FP1302 explores relationships between material and knowledge, combining different approaches associating museum issues, analytical methods, psychology and perception, as well as musical performance. It mostly focuses on historical harpsichords on the one hand, and wooden wind instruments on the other—two sets of musical instruments associated with a time and a culture of which very little documentation and knowledge are now available. The project deals with two particular points:

- the critical parameters of the “voicing process” in the harpsichord, of all the gestures and interventions concerning functional and musical modalities, on which the string plucking depends, and of the relationships between the string vibration features and results founded on a psycho-perceptual approach;
- the influence of the microstructural properties of wood on the functionality of wind instruments in a historical perspective.

The project originated partly due to the proven lack of material elements and historical sources about the excitation system of the harpsichord string—plectrum in feather of goose, crow or other species—and about the musical voicing. François Couperin, “Organiste du Roy” (king’s organist), is one of the few known historical sources. He summarizes the problem in a few words in his famous method *The Art of Touching the Harpsichord* released in 1717, urging young students to use “lightly-feathered [harpsichords], as this point is of infinite consequence” [8, 9] (see Fig.1). He emphasizes that, in any case, it is essential for performers “to [always] play on a well-feathered instrument”. However, these remarks are not enough to be able offer to the public today historically documented musical instruments, in terms of voicing and performance.

Fig.1

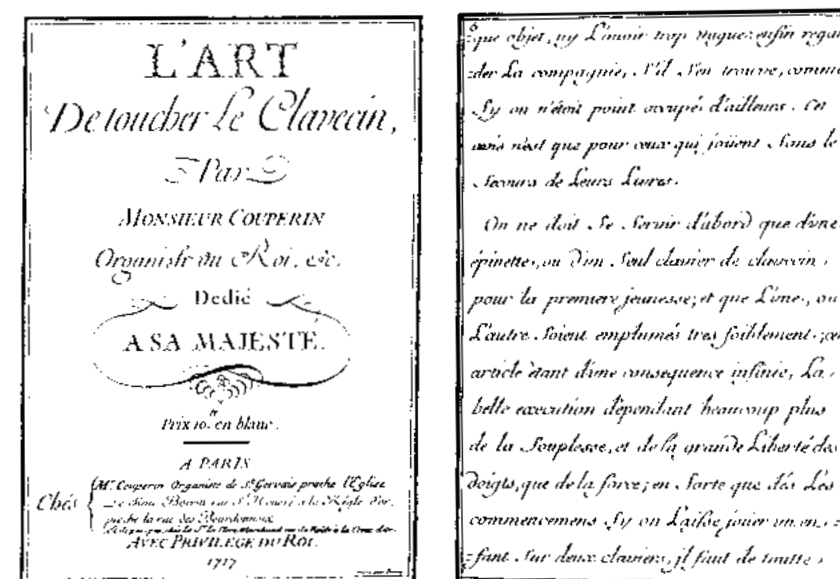

Fig.1

Cover and sample of the facsimile of François Couperin’s method. Composer, player and teacher in the court of Kings Louis XIV and Louis XV, François Couperin was one of the best harpsichord players in France during the eighteenth century. His method was first published in 1716 and then in 1717, the only change being the spelling of “Roy” changed to “Roi” on the cover. Translation of the original text by Couperin [10]: [...] When playing before a group, it is best to look at the company that has gathered, and not appear preoccupied. This advice is relevant only to those who are not playing from written scores. During the earliest years it is best to play only on a spinet or a one manual harpsichord, and that each of these be quilled only very weakly [the crow quill plectra of the harpsichord be set to produce a very light touch]. This is a very important point. Good execution depends much more on suppleness and great freedom for the fingers than it does on force. Consequently, if one starts off youngsters on a two-manual harpsichord, the small hand of the student will be strained when trying to make the keys “sound,” and from this the hands will become poorly placed and a hard touch will develop [...].

The FA-RE-MI project also started from the observation that a large diversity of wood species is traditionally used in the making procedure of various wind instruments, including oboes, flutes, serpents and basset horns. From usually long-winded written sources on this matter, physical models of wind instruments commonly used in the literature ignore the material properties in the constituting mathematical expressions. In the “Méthode raisonnée pour le hautbois” [11], published a few years later, François Joseph Garnier l’Aîné, First Professor at the National Music Conservatory of the nascent French Republic, in Paris, specifies that “boxwood, species employed to make oboes, should be dry and free of knots, and should show almost uniform porosity along its full length: [he says] almost uniform because the same piece of boxwood never shows the same porosity in all of its parts”. He adds that “makers should devote the hardest part of the piece of wood to the upper part, and the softest to the lower part.” This consideration echoes Johann Joachim Quantz’s text [12] “Versuch einer Anweisung die Flöte traversière zu spielen” published in Berlin in 1752: “Boxwood is more long-lasting, and consequently more commonly used than other species to make flutes; however, ebony provides a more beautiful and clearer tone”.

The team built up around this project is composed of researchers from the Lutheries-Acoustique-Musique team of d’Alembert Institute, Sorbonne University, Paris, and from and the Conservation-Recherche team of the Centre de Recherche sur la Conservation (CRC), Museum of Music, Paris.

2. Methods and Results

2.1. Harpsichords

2.1.1. Context: the voicing process

Since the plectrum is the part that sets a harpsichord string into motion (it controls the string’s “initial conditions”), harpsichord connoisseurs and practitioners have always focused their attention on the voicing process. This process of carefully selecting the materials (leather or quill, and more commonly now polyoxymethylene) and meticulously shaping the plectra is unavoidable for the delivery of a harpsichord that has a homogeneous sound and touch over the whole tessitura [13].

2.1.2. Of plectrum shape and jack velocity: some acoustical measurements

To rephrase and expand on the previous paragraph, we may state that providing a harpsichord with an appropriate voicing puts the player in the ideal position to render an expressive piece of music. It follows that two parameters appear to be fundamental in the production of harpsichord sounds: plectrum shape and the movement of the key-jack-plectrum system in a performance situation.

Fig.2

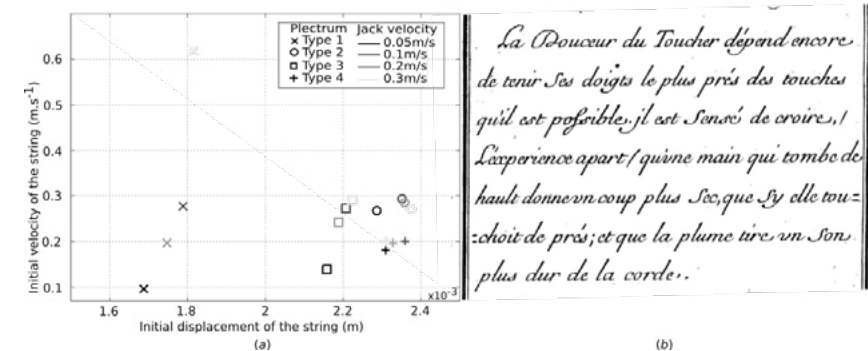

A parametric study was carried out using a robotic finger (ensuring reproducibility of measurements and avoiding weariness of a human operator), depressing with different velocities a key that was pushing a jack fitted with different plectra made of the same material but with different shapes [13]. In this study, the key/jack velocity is a parameter controlled by the instrumentalist, while the plectrum geometry is determined by the maker’s gesture.

We analysed plectrum deflection at string release time (using a high-speed camera), string trajectory during the plucking phase, string’s initial position (i.e., deviation from rest position at release time), speed and angle (using optical vibration sensors), and resulting sound (recorded by a microphone), described as sound level, resonance time, attack time, and spectral centroid, the latter being a measure of the location of energy in the spectrum, i.e., the more energy content in the high/treble frequencies, the higher the spectral centroid, providing a descriptor supposed to account for sound “brightness” [14].

Results [15] show that the plectrum deflection and string trajectory before release are quite independent from the key/jack velocity. Also, different plectrum shapes allow for different initial conditions: some plectra will consistently provide the string with larger initial displacements or velocities than others. More interestingly, it was found that some plectra allow for larger ranges in the string’s initial conditions, depending on the jack/plectrum velocity: in other words, these plectra allow the player to produce a larger variety of sounds

Fig.2 (a) Amplitude of the initial displacement (D_0) and speed of the string for 4 different plectrum shapes and 4 different key/jack velocities. Markers indicate mean values. (b) Copy of the original text by François Couperin, page 7, showing that these results were already suspected in 1716 [9]. Translation from the original text by Couperin [10]: “Smoothness of touch depends additionally on holding the fingers as closely as possible to the keys. It stands to reason (entirely apart from the fact that experience shows) that a hand that falls from a height will produce a drier blow than would one falling from close by and that the quill will draw a harder [harsher] sound from the string.”

when varying the key depression movement (see **Fig.2:** with Type 1 plectrum, there is more freedom to vary the initial velocity of the string).

2.1.3. Are different plectrum shapes perceived by musicians?

The study reported in the previous paragraph showed that the interaction between the gesture of the maker (voicing the plectra) and the player (pressing the keys) leads to a certain expressivity in harpsichord playing. As the plectrum shape appears to facilitate the expressivity in the player's gesture, the question that naturally followed was: how do players perceive and describe different plectrum shapes?

Two professional harpsichord makers made each a set of plectra for a single-keyboard, 56-key harpsichord. Makers were given identical jacks and raw material (polyoxymethylene) and "voiced" the harpsichord their own way. In the following, sets of plectra are denoted "V1" and "V2" respectively.

Professional harpsichordists took part in a free playing and verbalization task: For each of the voicings, the participants were simply asked to play the harpsichord as they usually would, and to engage in a conversation with the experimenters, expressing their feelings when playing. At the end of each phase, short musical excerpts were played by the harpsichordists and recorded [14]. Between the two phases, participants took a short break outside of the room while the jacks were changed, so that they were neither aware nor told that they were playing with a different set of plectra when back in the test room.

In order to compare perceptual measurements with physical measurements, at separate occasions, the following two measurements were taken: a) "activation force", for each key, i.e., the minimum force needed to activate the note, and b) sound recording of isolated notes: all keys slowly played in a row with a medium-velocity pressing motion by an experienced harpsichord player on our team.

Our method for analysing the verbalizations is thoroughly described in [16, 17, 18] and only landmarks are given here. First, the recorded verbalizations were transcribed. Then a semantic analysis was done, identifying the meaning of the words used by the participants. Linguistic methods were applied: word search, context interpretation, search for linguistic marks in order to determine semantic proximities and distances. Words referring to similar perceptual aspects were grouped into the semantic categories listed in **Table 1:** Each category groups words of similar meaning (not shown here) under a label chosen from these words (titles in the column "Semantic category"), explanation of this meaning is given in the "Associated perceptual aspect" column as the result of the linguistic analysis of verbalizations.

Then all sentences uttered by the players, organized in semantic categories (e.g., all sentences about "attack" were grouped and analysed

Table 1

SEMANTIC CATEGORY	ASSOCIATED PERCEPTUAL ASPECT
Loud / hard / strong	Volume of the sound, hardness of the plectrum, "strength" of the voicing
Length	The way the sound lasts and evolves after note onset
Attack	Either the onset part of the sound, or the way the sound behaves in response to a finger gesture
Homogeneous	Equality / inequality of sound and touch across notes and tessituras
Evolution	Graduality over the whole tessitura (gradually lighter from bass notes to treble notes)
Sound descriptors	Sound quality, or timbre

together, then all sentences about "length", etc.), were reallocated to each voicing, using context information (who is playing, who is speaking, what voicing is being played V1 or V2), and linguistic tools (mostly grammatical and syntactic) were used to discover how each voicing was described by the players within this framework of semantic categories (i.e., what are the evaluations of V1 and V2 according to the criterion "Homogeneous"?).

A perception-based description of V1 and V2 was obtained from this linguistic analysis. The main perceptual results can be summarized:

- a. V1-sounds are louder than V2-sounds,
- b. V1-plectra are harder than V2-plectra,
- c. V2-sound are more resonant than V1-sounds.

These three perceptual results are confirmed by the acoustical and mechanical measurements:

- a. Isolated notes produced with V1 are louder than notes played with V2 (typical difference 1 dB(A)), and for a given excerpt and a given musician, V1 systematically produces louder equivalent sound levels,
- b. one needs to apply 5 to 10 g more to trigger a note with V1, for notes above C3 (no difference seen below this note),
- c. V2-notes have a slight tendency to have a longer resonance time than V1-notes.

Other perceptual results are:

- a. V2 gives more dynamics than V1,
- b. V1 achieves both a better equality and a better evolution of sound and touch over the tessitura. This latter point deserves further investigation.

As a summary of this part that approached the voicing process with a multidisciplinary method combining psychology, musicology and experimental acoustics, we state that:

- the interaction of the maker's (voicing) and player's (pressing) gestures sets the frame for the expressivity of harpsichord playing,

Table 1 Summary of semantic categories.

- plectrum geometry is very influential: musicians can feel very tiny differences, describe them, and adapt their playing to different voicings,
- perception of voicing is multimodal, with a strong auditory-tactile integration: loudness (sound) and hardness (plectrum) evaluations are well correlated. This is not as clearly observed on the physical side: equivalent sound level and minimum triggering force measurements are poorly correlated (see Fig.3).

Fig.3

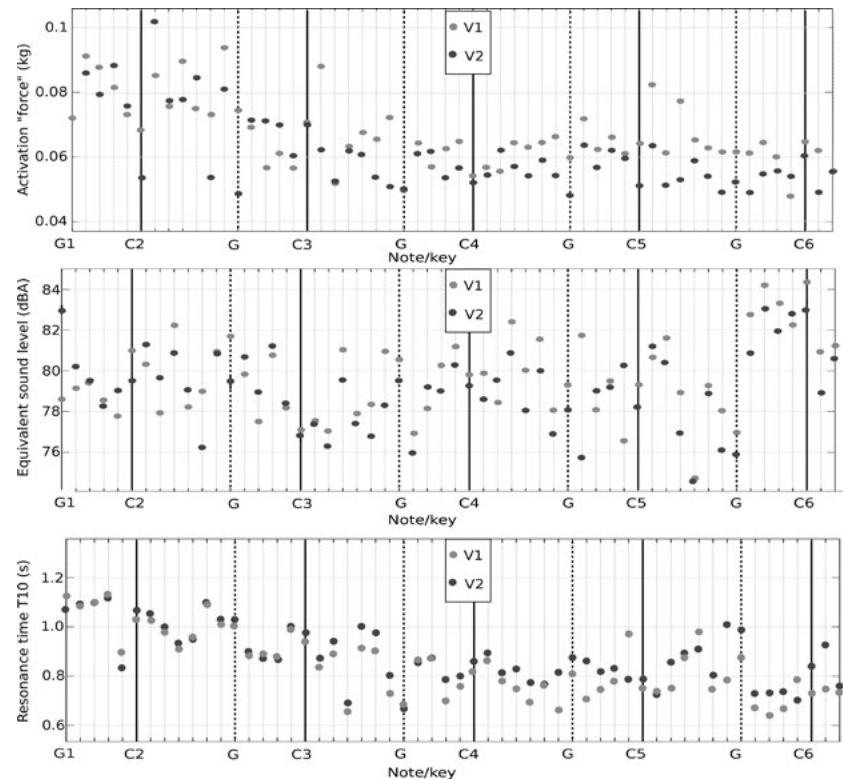

2.2. Wind Instruments

In wind instruments made of wood, the surface condition of the bore has a critical impact on the playability and hence on the radiated sound. Indeed, aging wood typically introduces cracks in the resonator leading to leaks and making the instrument hardly playable. This is the reason why makers and players attach particular importance to keep the inner surface of the bore smooth. For deontological reasons, instruments in museum collections cannot receive such treatment, and

Fig.3

From top to bottom, minimum triggering force (in kilograms), equivalent sound level (in dB(A)), resonance time T10 (in seconds) for each note of each plectrum set (pink dots for V1 and blue dots for V2).

consequently are extremely rarely played. This study aims at quantifying the impact of polishing on the acoustics of the resonator, for different wood species traditionally used in instrument-making. From a cultural heritage conservation point of view, this point is crucial in order to synthesize the sound that instruments of museum collections would produce in playing conditions. For that purpose, an experimental method has been developed to quantify the acoustic dissipation in a cylindrical pipe. It was subsequently applied to wooden pipes manufactured by a recorder maker, at different steps of the making procedure. This part of the FA-RE-MI project, relying on both researchers and craftsmen skills, is intended to provide essential information for museum curators as well as experimental results of great interest for instrument-makers.

2.2.1. Estimating acoustic dissipation in a cylindrical pipe

The first step of this study consisted in implementing a method to estimate the attenuation factor of pressure waves, equal to $\pm \text{Im} \left(\frac{2}{L} \arctan(\sqrt{1-2Z_1/Z_2}) \right)$ [19] where L is the air column length and Im stands for the imaginary part of a complex number. The \pm sign is chosen so that the attenuation factor is positive. Z is the input acoustic impedance of the pipe, defined as the ratio between acoustic pressure and acoustic flow at one end, with the other end sealed. Subscripts 1 and 2 correspond to an air column length equal to L and $L/2$ respectively.

2.2.2. Manufacturing the wooden pipes

In order to report on the acoustic dissipation in wooden resonators of wind instruments, five cylindrical pipes were manufactured by a recorder maker: one was made of African blackwood (*dalbergia melanoxylon*), one of boxwood (*buxus sempervirens*), one of pear wood (*pyrus communis L.*) and two of maple (*acer pseudoplatanus*). These species are commonly used to make numbers of wind instruments including modern clarinets and oboes, recorders, baroque oboes, serpents and cornetts. The pipes are parallel to the fibre direction, except one, made of maple, at an angle of 60 degrees. The two maple pipes are made out of the same piece of wood. All pipes have the same dimensions. The manufacture process consists first in shaping the external surface of the wood pieces with a gouge (see Fig.4), and then drilling the cylinders with a stainless-steel reamer. Eventually, the inner surface of the pipes is polished using fine sandpaper.

2.2.3. Attenuation factors in the wooden pipes

For each pipe, input impedances Z_1 and Z_2 are measured between 50 Hz and 2.5 kHz. For Z_1 , the air column length is equal to 239 +/- 1 mm. For Z_2 , the air column is twice shorter, equal to 119 +/- 1 mm. The far end is closed with an airtight sealing made of aluminum and modelling

Fig.4



Fig.5

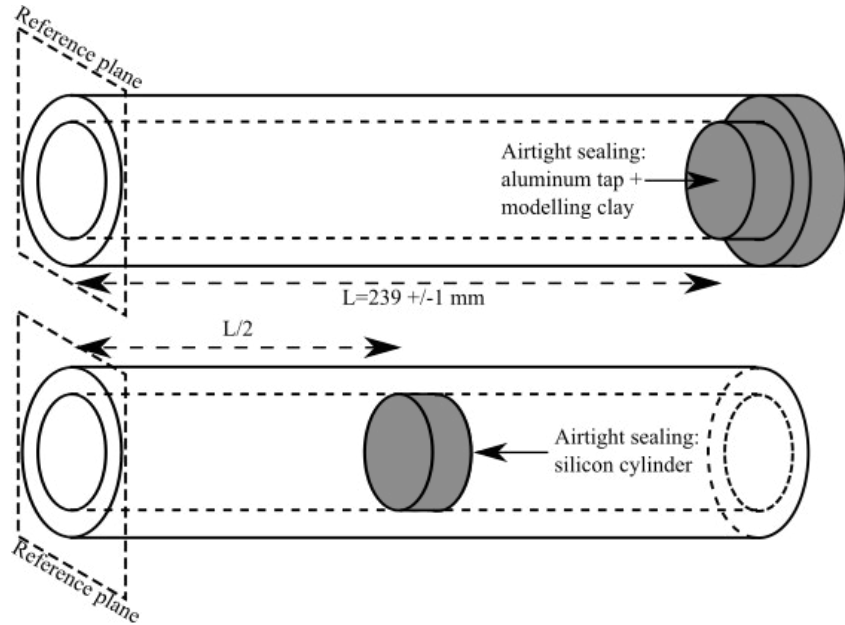

Fig.4

External shaping of the maple pipe.

Fig.5

Experimental setup used to estimate the acoustic dissipation in a cylindrical pipe. The attenuation factor is derived from two impedance measurements: one with an air column length twice as long as the other. For each measurement, the far-end is closed with an airtight sealing.

clay, or silicone (see Fig.5). The measurement method uses a sensor from CTTM and LAUM, Le Mans, France, placed at the reference plane. Its principle is described by Le Roux *et al.* [20].

For each wooden pipe, the attenuation factor is estimated twice during the manufacture procedure: before and after polishing (see Fig.6). These curves are compared to a theoretical attenuation factor, calculated using a model of smooth and non-porous cylinder of same dimensions [21].

Fig.6

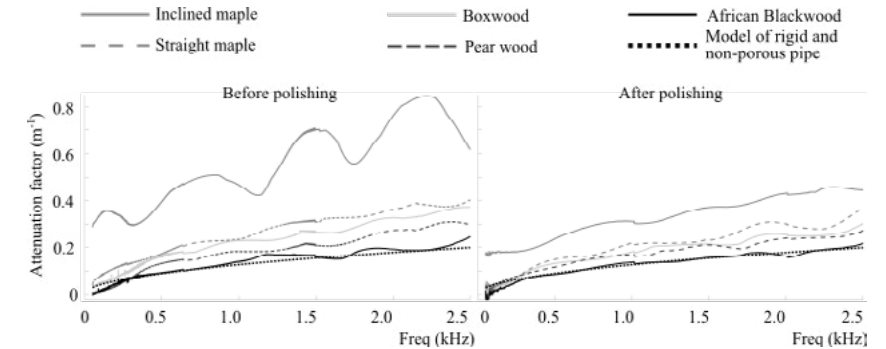

2.2.4. Results

The estimates of attenuation factors give insight into how the acoustic dissipation varies among the wood species considered. Except for the inclined maple pipe, the ratios between estimates and model show small fluctuations between 300 Hz and 2.5 kHz. Over this interval, their average values range from 1.1 to 2.0 before polishing. Such a discrepancy, shows that differences of roughness and wood porosity among the wood species strongly affect the acoustic dissipation inside the pipes. However, polishing tends to lessen the differences between wood species and theoretical model. Indeed, after polishing, the ratios between estimated attenuation factors and the theoretical value are reduced to less than 1.6. In contrast with the other curves, the attenuation factor in the African blackwood pipe is barely affected by polishing, as it is relatively close to the theoretical value, calculated in the absence of roughness and porosity, even before polishing.

This experiment allows us to rank the wooden pipes, in terms of acoustic dissipation: maple, boxwood, pearwood and African blackwood from largest to smallest attenuation factors. This order is the same before and after polishing. These results also suggest that inclining the pipe direction relative to the fibre direction considerably

Fig.6

Attenuation factors in wooden pipes of same dimensions, made of maple, boxwood, pear wood and African blackwood, before (left) and after (right) polishing. The direction of each pipe is parallel to the fibre direction, except that of the inclined maple pipe, at 60 degrees. The dotted black curve shows the theoretical attenuation factor in a model of smooth and non-porous pipe, with same dimensions.

increases the acoustic dissipation, as both the inclined and the straight maple pipes are made out of the same piece of wood. Indeed, on average between 300 Hz and 2.5 kHz, the attenuation factor of the inclined maple pipe is 2.0 times larger than that of the straight maple pipe before polishing, and 1.5 times larger after polishing. Today, in western wind instrument-making of high quality, African blackwood is extensively exploited. Also, wooden resonators are parallel to the fibre direction, except for a few instruments with a curved bore, such as serpents or cornetts. Such manufacturers choices, together with polishing, tend to reduce the acoustic dissipation inside the bore, and hence to favour oscillations of the air column at its resonance frequencies. In contrast, makers from other cultures traditionally use wood species known to be more porous, e.g., mulberry or apricot wood for zurna or duduk, bamboo for bansuri. Such instruments allow performers to reach playing frequencies relatively far from the bore resonances, compared to western instruments like clarinets or oboes. These qualities are particularly adapted to play wide glissandi, vibrato or microtones, commonly used in numbers of traditional non-Western repertoires.

3. Discussion

The results we obtained (see **Table 2** summarizing the experiments we did) show that crossing different approaches—mechanical characterization, acoustics, motion analysis of musicians, historical problematics—is an efficient methodology which offers an in-depth look on the involved phenomena. This contribution leads to a better understanding of the relationships between the materials used by makers, the expertise involved in the making process, and its implications in the musician-instrument interaction.

Instrument	Tests	Publication / Section
Harpsichord	Mechanical and acoustical characterisations of the plectrum-string interaction for several plectrum shapes and several instrumentalist controls	[13] / 2.1.2
	Perception characterisation of plectrum voicing	[14] / 2.1.3
Woodwinds	Theoretical modelling of acoustic propagation in porous pipe	[17]
	Experimental quantification of acoustic dissipation due to bore effect	[17] / 2.2.3

Table 2 Summary of tests carried out during the Faremi project, with related publications and associated sections in this article.

By finely adjusting each plectrum of the harpsichord, the maker is in a position to modify the sound produced by the instrument. Whereas this fact is well-known by makers, few studies based on an acoustical approach have considered this major aspect so far, as harpsichordists are supposed to have but little possibility for control on their instrument. By investigating the harpsichord with a multi-disciplinary approach, we show that the player is particularly sensitive to the maker's gesture and can discriminate several plectrum shapes. Further he/she can adapt his/her playing or even has different expressive possibilities at his/her disposal. For some plectrum shapes, the harpsichordist even proves to have more expressive possibilities and musical interpretation. This study shows that shaping plectrums affects the player's perception. Thus, a historical approach of this widely discussed issue is relevant. Whereas this study involves a unique material of plectra, it highlights that geometrical parameters alone—that is, the maker's gesture responsible for the “voicing process”—are significant. Consequently, the voicing process fully impacts the musical discourse. Consequently, our results confirm that the lack of precise knowledge of methods, materials and forms of harpsichord plectra makes it impossible to guarantee historical relevance during concerts on old instruments.

Similarly, in acoustical models of wind instruments, the surface specificities of the material (porosity and roughness) in the resonator are usually not taken into account. However, the estimation of acoustic dissipation in various wooden pipes shows how selecting different wood species and polishing the inner wall of the resonator affect the air column resonances. These experimental results point out some gesture in the maker's practice with considerable impact on the sound produced and the instrument playability. Further studies will aim to investigate the influence of oiling the bore, another essential step in the manufacture and the maintenance of wooden wind instruments. Among various spin-off benefits, next steps will aim at simulating wind instrument responses in playing conditions (i.e., with polished and oiled bore), from “dry” non-played historical instruments from museum collections, simply using non-invasive impedance measurements. So, just like the harpsichord study, pointing the musical and historical importance of plectrum, our work on the role of wood in the production of wind instruments addresses instrument-making issues and enhances contemporary know-how.

During the COST action WoodMusICK, the results of the FA-REMI project have met direct applications in finding information about historical instruments. Indeed, two facsimiles of oboes from Christophe Delusse—in the collection of the Museum of Music, Paris (inv. nos. E.2180 and E.2182)—known for their exceptional original condition

[22] have been made and are henceforth frequently played. Also, in 2018, all feathers plectrums of an emblematic harpsichord made by Jean-Henri Hemsch in 1761 in Paris, and nowadays part of the collection of the Museum of Music in Paris (inv. no. E.974.3.1), have been changed and their musical influence perception have been explored during and after the restoration. These interventions address the issue of timbre and musical practices in France at the beginning of the nineteenth century and will engage new research over this period involving musicians and musicologists.

Museum collections have many harpsichords which today cannot be played, since their state of conservation does not allow it, from a deontological conservation and restoration point of view. Likewise, almost all wooden wind instruments are not played because of damage that would certainly be incurred during the playing. However, the results obtained by the FA-RE-MI project make it possible to approach some of the intangible cultural values they contain, without having to play them. As we have seen, a set of non-invasive physical and mechanical measures make it possible to describe and document the functionality of these corpora. The musical instruments in museums can thus still talk about music, be witnesses of the musical taste and know-how of their time!

Beyond musical, stylistic or historical questions, the results obtained highlight the role of raw material in the sound wave creation. They allow, by comparison between old and current objects, to evaluate the development of the mechanical properties of the materials, the feather, the oils, the woods used in the manufacturing process. The acquired detailed knowledge of these phenomena acquired opens the way to finding conservation techniques that could, for example, better stabilize, for a longer time, the mechanical properties of ancient feathers which currently receive no conservation treatment. There is every reason to believe that knowledge of the influence of deposited oils within wind instruments is the required starting point for the design of temporary protection products. These coating materials should have the required acoustic quality to let the instruments express their musicality, and at the same time should provide a reversible and effective layer of protection, thus allowing music playing on historically documented instruments, in conformity with ICOM recommendations, and within appropriate acoustic performances.

As a result, bringing makers, musicians, historians, curators, restorers and acousticians together around the musical instrument allowed us to enhance our knowledge, but also and specially, to bridge the gap between the practices of the past time and of the present day.

ACKNOWLEDGEMENTS: The authors warmly thank musicians Benjamin Alard, Maria Lúcia Barros, Olivier Beaumont and his students, Florian Carré, Michèle Castellengo, Mathieu Dupouy, Jean-Luc Ho, Annie Kalifa, Françoise Lengellé, Arnaud Pumir, Lola Soulier and colleagues Brigitte Cruz-Barney, Jean-Claude Battault, as well as the instrument-makers Philippe Bolton, Gilles Thomé, Pierre Ribo, Marc Ecochard, Bruno Reinhard, Emile Jobin and Maurice Rousteau for their support, help and generosity. A special thought goes to our colleague and friend, Bruno Salenson, a wind instrument maker who recently left us.

References

- [1] T. Ono and M. Norimoto, "Study on Young's modulus and internal friction of wood in relation to the evaluation of wood for musical instruments," *Japanese J. of Applied Physics*, vol. 22, no.1, pp. 611-614, 1983.
- [2] M. E. McIntyre and J. Woodhouse, "On measuring wood properties, Part 1," *J. Catgut Acoust. Soc.*, vol. 42, pp. 11-15, 1984.
- [3] M. E. McIntyre and J. Woodhouse, "On measuring wood properties, Part 2," *J. Catgut Acoust. Soc.*, vol. 43, pp. 18-24, 1985.
- [4] M. E. McIntyre and J. Woodhouse, "On measuring wood properties, Part 2," *J. Catgut Acoust. Soc.*, vol. 45, pp. 14-23, 1986.
- [5] C. Y. Barlow and J. Woodhouse, "Of old wood and varnish: peering into the can of worms," *J. Catgut Acoust. Soc. II*, vol. 1, no. 4, pp. 2-9, 1989.
- [6] D. W. Haines, "The essential mechanical properties of wood prepared for musical instruments," *J. Catgut Acoust. Soc.*, vol. 4, no. 2, pp. 20-32, 2000.
- [7] M. Mersenne, *Harmonie universelle, contenant la théorie et la pratique de la musique. II "Des instruments," vol. 3*. Paris: CNRS, 1965, p. 24.
- [8] F. Couperin, *L'Art de toucher le clavecin*. Geneva: Minkoff Facsimiles, 1986.
- [9] P. Montan, *L'Art de toucher le clavecin de François Couperin: Autour du doigté*. Bern: Peter Lang Publishing, 2004, p. 31.
- [10] F. Couperin. Excerpt of *The Art of Playing the Harpsichord*, trans. from the original *L'Art de toucher le clavecin*. Boston: Cengage Editor, Boston, 1717 Massachusetts, USA. Available: https://www.cengage.com/music/book_content/049557273X_wrightSimms/assets/ITOW/7273X_36_ITOW.pdf
- [11] F.-J. Garnier (l'Ainé), *Méthode raisonnée pour le hautbois*. Paris: Pleyel Facsimile, c.1798.
- [12] J. Q. Quantz, "Ch. 1: Histoire abrégée & Description de la flûte traversière," in *Essai d'une méthode pour apprendre à jouer de la flûte traversière*. Berlin: Chez Chrétien Frédéric Voss, 1752, p. 28.
- [13] F. Hubbard, *Three Centuries of Harpsichord Making*. Cambridge, MA: Harvard University Press, 1965.
- [14] J. M. Grey, "Multidimensional scaling of musical timbres," *J. Acoust. Soc. Am.*, vol. 61, no. 5, pp. 1270-1277, 1977.
- [15] A. Paté, J.-L. Le Carrou, A. Givois and A. Roy, "Influence of plectrum shape and jack velocity on the sound of the harpsichord: An experimental study," *J. Acoust. Soc. Am.*, vol. 141, no. 3, pp. 1523-1534, 2017.
- [16] A. Paté *et al.*, "Perception of harpsichord plectra voicing," *Acta Acust. united Ac.*, vol. 103, pp. 685-704, 2017.
- [17] A. Paté, "Lutherie de la guitare électrique solid body: Aspects mécaniques et perceptifs," Ph.D. dissertation, Université Pierre et Marie Curie, 2014.
- [18] A. Paté, J.-L. Le Carrou, B. Navarret, D. Dubois and B. Fabre, "Influence of the electric guitar's fingerboard wood on guitarists' perception," *Acta Acustica united Ac.* 101 (2015), pp. 347-359.
- [19] H. Boutin, S. Le Conte, S. Vaiedelich, B. Fabre and J.-L. Le Carrou, "Acoustic dissipation in wooden pipes of different species used in wind instrument making: An experimental study," *J. Acoust. Soc. Am.*, vol. 141, pp. 2840-2848, 2017.
- [20] J.-C. Le Roux, M. Pachebat and J.-P. Dalmont, "A new impedance sensor for industrial applications. *Proc. Acoustics 2012 Conf.*, Nantes, 2012, pp. 3503-3508.
- [21] C. Zwikker and C. W. Kosten, *Sound Absorbing Materials*. New York: Elsevier, 1949, pp. 25-32.
- [22] S. Vaiedelich, B. Salenson, S. Le Conte, L. Soulier and T. Maniguet, "Reconstruction of oboes made by Christophe Delusse: From the material sources to the sounding instrument," *Proc. 3rd Annual COST FP1302 WoodMusICK Conf.*, Barcelona, 2016, pp.143-147.

Early Development Process of the Steinway & Sons Grand Piano Duplex Scale

NIKO PLATH (1), KATHARINA PRELLER (2)

(1) Institute for Systematic Musicology, University of Hamburg, Germany

(2) Research Institute for the History of Science and Technology,
Deutsches Museum Munich, Germany

Abstract:

This article presents an attempt at retracing the early development process of the grand piano's duplex scale mechanism by combining an evaluation of contemporary written sources with acoustical measurements on extant grand pianos. For Steinway & Sons, 1870–1890 was an extremely innovative period, mainly driven by the work of C. F. Theodore Steinway. For the invention of the duplex schematic, which was patented in 1872, he claimed to have been inspired by Hermann von Helmholtz's research on the perception of higher order harmonics. In appreciation of the impact of his work, Steinway & Sons consecutively presented three grand pianos to Helmholtz. Design parameters and acoustical measurements on several historical Steinway grand pianos—among them the earliest of Helmholtz's pianos—are compared to investigate if the intended effect instantly emerged, or if it was firstly a theoretical concept, which was later refined to enhance a certain tonal character.

1. Introduction

The grand pianos of Steinway & Sons (hereafter referred to as S&S) experienced one of their most inventive periods under the technical direction of C. F. Theodore Steinway (1825-1889). For him and other piano makers, the research and knowledge in acoustics had become an increasingly important foundation in piano making. Hermann von Helmholtz's *On the Sensations of Tone* [1] was an especially useful resource due to its many practical experiments on musical instruments and new approaches to the theory of timbre perception [2]. The most prominent result of these endeavours may well be the duplex scale (patented in 1872), which has become an integral part of S&S's grand pianos [3]. Despite its scientific basis, this invention caused some controversy: several competitors criticized it, and others copied it.

Until now, there have been few attempts to verify how such constructions worked in their early years and how they changed. As an example, Henry Steinway, Jr. stated in his 1859 patent, that "grand piano overstringing" was advantageous in two ways: longer bass strings could be accommodated, and it would be possible to position the bridge closer to the centre of the soundboard. When Paul Poletti tested these statements by measuring the respective parameters before and after the implementation, he found that the differences were not significant [4]. Nevertheless, cross-stringing has become a standard feature of grand pianos.

A few surveys on the functionality and effect of the duplex scale have been published focusing on the modern grand piano (as will be outlined in section 3). This article adds a historical perspective on the motivation behind the invention, its development within the first two decades, and the perceivable effects of these early versions. By evaluating relevant historical documents, some of which have not been taken into account before, and by comparing these results with measurements of the scale and vibrational behaviour of selected historical S&S grand pianos, some central issues will be addressed: Did the duplex scale work as intended from the beginning? How is its theory related to the practice in the pianos? Why were modifications made? To what extent did Hermann von Helmholtz contribute to its invention?

2. C. F. Theodore Steinway and His Relation to Hermann von Helmholtz

C. F. Theodore Steinway, the first son of the company's founder, was the most innovative piano maker in the history of S&S in terms of the number of patents obtained, a total of 45 between 1868 and 1885 [5] (see Fig.1).

These inventions are manifestations of Theodore's knowledge about acoustics. As Alfred Dolge summarized in 1911: "He demonstrated to what extent science can aid in the development of the piano

Fig.1

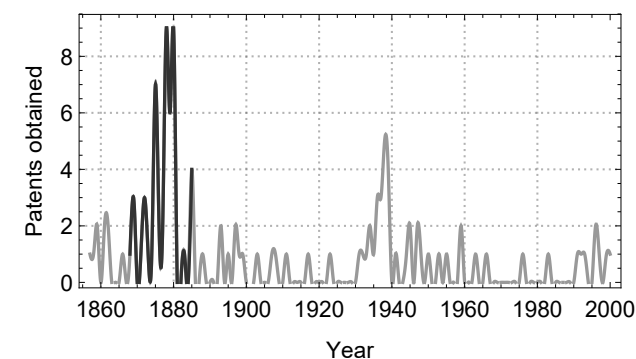

by his own productions, and thus broke the path for the enormous development of the past 30 years [c.1880-1910]. This is more than all the empirics have ever done" [6].

When consulting contemporary reports about Theodore's biography it is important to note that almost all of this information originated directly from the family members themselves or people around them. Fanny Morris Smith for instance was trained in the S&S factory [7] and her book *A Noble Art. Three Lectures on the Evolution and Construction of the Piano* [8] was published by Charles Tretbar, William Steinway's advisor. The Steinway family compiled an undated pamphlet "On the Founding and Development of Steinway", which presents an insider point of the family's history [9]. According to the latter source, Theodore's varied talents became apparent at an early age and so he received special tuition in acoustics whilst at school, at the Jacobson Institute in Seesen. The then director, Dr. Benjamin Ginsberg, gave Theodore access to the "Jacobsohn library and lecture-room, the latter containing all the acoustic and scientific apparatus known at that period. In return Theodore assisted the teachers and professors of acoustics and mathematics in their lectures and experiments" [9]. Ginsberg seems to have played a key role in Theodore's career: "This intimate relation to the scientist in his youth prevented Theodore from ever becoming a mere empiric. It was the cause of the restless search he later so forcibly demonstrated for the scientific laws underlying the construction of the pianoforte" [6].

Another particularity about Theodore's biography is that he spent most of his life in Germany and thus remained in exchange with the cultural and scientific communities there. Only between 1865 and 1880, when he was indispensable in the factory due to the death of two of his brothers, did he relocate to New York, but repeatedly made extended

Fig.1 Number of patents per year granted to Steinway & Sons. The period of Theodore's activity is emphasized.

journeys back to Braunschweig [10]. During one such stay from summer 1869 to fall 1870, Theodore and Hermann von Helmholtz likely met for the first time. In a letter to Helmholtz, Theodore sent his best regards and stated that he remembered their “stimulating conversations” in 1870 with pleasure [10]. According to Fanny Morris Smith, they had already become acquainted several years before: “Helmholtz, [Theodore’s] friend and companion, the greatest and most ingenious of all acousticians, was his most stimulating influence. In many of the researches of ‘Die Lehre von Tonempfindungen’ [sic] did the great pianomaker lend a hand” [8]. When Helmholtz published this book in 1863, Theodore still lived in Germany, but there is no evidence of any contact between them at that time. Altogether only a few letters and meetings are documented, none dating before 1870 [10].

The notion of a close collaboration between Helmholtz and the Steinways still recurs frequently based on these contemporary reports. The piano material supplier Alfred Dolge claimed that Theodore even “returned to Germany to be near Helmholtz and benefit by that great savant’s epoch-making discoveries.” [6] One of Helmholtz’s motivations to exchange ideas with skilful instrument makers was to put his musical findings—mainly regarding just intonation on keyboard instruments—into practice. In 1871 he also encouraged the Steinways to try this in their pianos, “perhaps with a similar system to a pedal harp but without a far too complicated mechanism” [11]. Above all, Helmholtz was a passionate piano player. In appreciation of the scientist’s impact on their pianos but also for promotional purposes, the Steinways sent a grand piano to him in 1871 (today located at Deutsches Museum Munich, see section 5), and two more in 1885 and 1893, respectively. In return, S&S printed his endorsements regarding the quality of their pianos and most notably the positive effects of the duplex scale in their catalogues.

3. Functional Principle of the Duplex Scale

As described in the patent, the basic idea of the duplex scale is to bring “the vibrations of that portion of the string which is situated between the agraffe and the tuning pin [further denoted as front duplex], in proportion to those of the main portion of the string”. For the section of string between the bridge and hitch pin (further denoted as rear duplex) he proposes to bring “[...] the longitudinal vibrations of that portion of the string [...] in proportion to the vibrations of the main section of the string, so that the sounds due to these longitudinal vibrations are brought in harmony with the tone of the main section of the string, and the purity and fullness of the tone of the instrument is improved” [3] (see Fig.2).

Fig.2

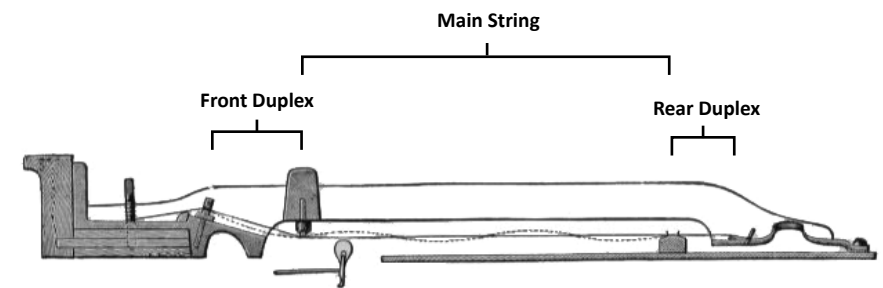

Although Theodore extensively describes the audible effects achieved by the duplex scale, the actual physical process is covered rather superficially. In his understanding: “The main agraffe, which supports the string only at one point, allows the transverse vibrations to extend to that part of the string between the said agraffe and the tuning-pin, the vibration of this part being in a direction opposite to that of the main section of the string” [3]. Due to the precisely proportioned length of the duplex string, the string’s termination at the agraffe is said to act as a “theoretical nodal point” for the corresponding partial. The patent does not give any explanation for the alleged process of the coupling of longitudinal duplex string vibrations into the main string. Currently, longitudinal string vibrations are considered to play an important role for tone production in the bass and midrange but have no perceivable effect in the treble [12]. However, the contribution of the non-mensurated rear string end to the string-bridge-soundboard coupling is comprehensively discussed [13-15].

An encompassing study of the duplex scales on a modern grand piano is presented by Öberg [16] and summarized by Öberg and Askenfelt [17]. Important findings on the rear duplex are among others: damping the rear duplex string increases the corresponding partial of the bridge vibration by 3 dB while the rest of the spectrum remains unaffected. Crosstalk through the bridge to rear duplex strings of other notes exists, and the effect of rear duplex strings on the bridge motion seems to decrease with “more complex” harmonic relations (unison – octave – double octave – twelfth) [17]. As the main effect of the front duplex Öberg and Askenfelt state that “dampening not only removes the front duplex tone in the bridge motion, but also makes the main string fundamental and partials weaker and shorter in duration.” [17] This contribution is also observable in the radiated sound (see Fig.3) and is audible even to non-experts. In the front duplex string motion, the fundamental frequency of the main string (further denoted as $f_{0_{\text{main}}}$)

Fig.2 Illustration of the string parts in piano treble range. After Fanny Morris Smith, [8, p. 59].

is 3 dB stronger than the fundamental frequency of the duplex string (further denoted as $f_{0_{\text{duplex}}}$). When plucking the front duplex string, $f_{0_{\text{main}}}$ is reduced but still observable in the duplex string motion.

Fig.3

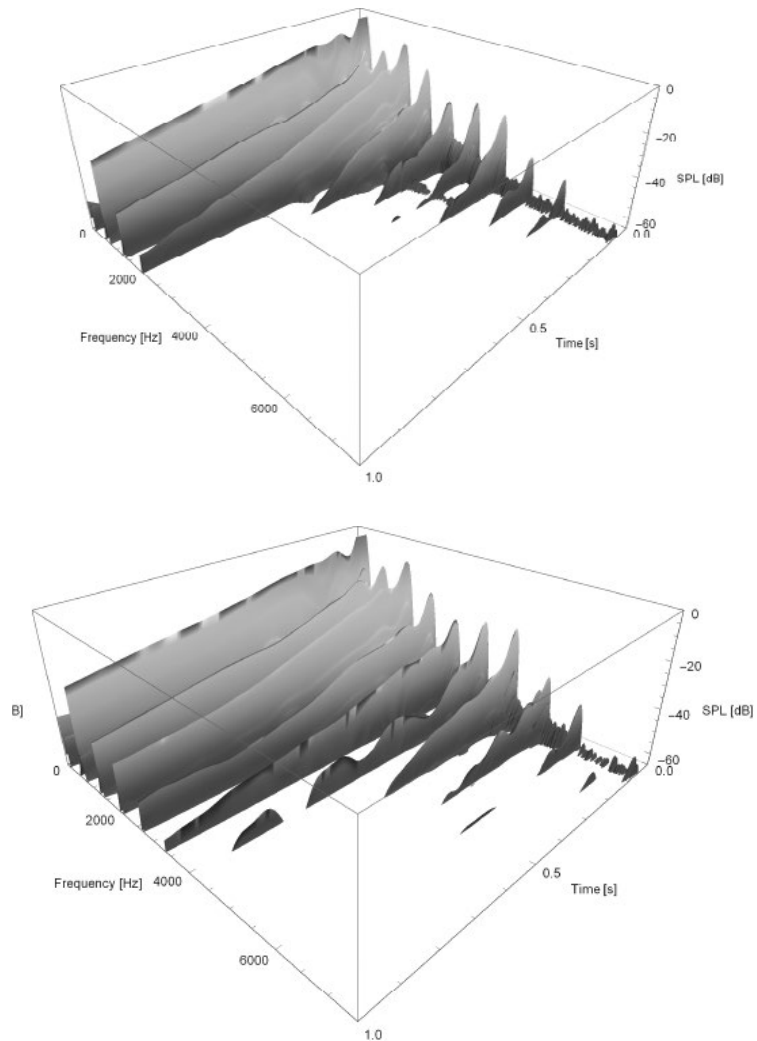

Fig.3 Spectrogram of radiated sound of forte played E5 note on a modern concert grand with (top) damped and (bottom) undamped front duplex. $f_{0_{\text{duplex}}}$ at 5.3 kHz. Reference sound pressure $p_0 = 0.063$ Pa.

Regarding the coupling between the main string and the front duplex, Öberg and Askenfelt do not give a detailed explanation, but assume the string termination under the capo d'astro bar to be “not well defined”. Further, “due to stiffness the string may exhibit a vertical rocking motion under the capo bar which transmits the motions of the main and duplex string rather effectively across the termination” [17]. Recent measurements give insight into the front duplex string coupling: due to the capo d'astro bar the main string faces different impedances for (at least) both transverse polarizations (parallel and perpendicular to the soundboard) which increase if the duplex string is undamped [18]. The existence of more high partial energy on the main string if it is coupled to a second string can be thus explained, despite being counter-intuitive at first glance. The effect does not depend on precise mensuration (consistent with the current realization), but on the angle of the front duplex string to the main string (a greater angle should increase the difference of impedances between polarizations), and type of coupling (agraffe/capo d'astro). The effect is, therefore, a result of complex boundary conditions instead of partial amplification by “sympathetic” co-vibration. In a metaphorical sense, the front duplex string can be understood more as working “against” the main string, contrary to Theodore’s concept of working “in harmony”.

4. Documentary Evidence about the Development

In the case of the duplex scale, the preliminary considerations probably started a long time before the patent application. Besides the duplex scale, Theodore registered two other new constructions in May 1872, both of them regarding plate improvements (U.S. patents No. 127,383: Monitor grand cupola plate and No. 127,384: Small upright cupola plate) [5]. Their preparations date back to Theodore’s visit to Germany in 1869-70, where he “carefully studied the latest achievements of the steel and iron industry” [9]. Some of the ideas had already transformed into physical models as early as March 1871, according to one of William Steinway’s diary entries: “In aft. Theo. shows me the new Plate of the Grand Piano, also wooden pattern of the new small Upright, which is nearly ready” [19, entry on March 25, 1871].

Likewise, Theodore’s meeting with Helmholtz in 1870 might have already been the starting point to refine the sound qualities of the piano. In his studies Helmholtz dealt with the impact of several sound shaping factors, such as “the properties of the hammer, nature of the blow, striking place of the hammer, characteristics of the string, radiation of the soundboard [...] and the length, breadth, and dip of the keys” [2]. For the invention of the duplex scale, Theodore profited especially from the new knowledge about timbre and the theory of resonance

phenomena, but also from new tools for sound analysis. Helmholtz's resonators, a series of brass or glass spheres of various diameters, filter particular overtones out of a complex sound. In Theodore's own words, it was this fundament that "prompted us to study by means of these instruments [the resonators], if what science has proven to be the richest tone, could come to reality in the Steinway piano" [20]. These efforts resulted in the duplex scale. Theodore was finally granted the U.S. patent "Improvement in Duplex Agraffe Scales for Piano-Fortes" on May 14, 1872. The accompanying drawing in the patent shows both front and rear duplex sections and specifies that the only resulting intervals are octaves, ranging from one to six octaves above the respective fundamental note.

Six weeks earlier, on March 30, the invention is mentioned for the first time in William's diary, yet apparently a proper designation was still missing: "In afternoon with Theo & Albt [Albert Steinway] uptown looking over points of the new Upr & grand patents, cupola Iron frame & increasing length of strings on the vibrating nodes" [19]. An entry three days later states a little more precisely: "...at Theodors house, looking over his new three scale Patent with Mr. Hauff" [19].

On April 26, 1871, the first grand piano to include the duplex scale (ser. no. 25.000) was already present in the warerooms [19], even before the patent was registered. This implies that the invention had either been completed and applied before the piano plate's casting or that it was attached as a separate piece at a later point. This latter method is documented on a few pianos built prior to 1875, some even before 1872, and will be discussed with examples in section 5. Their common characteristic is that the front duplex section produces only octaves as described in the patent, but the rear section is missing. This is because the hitch pins were positioned very close to the edge of the plate, so that duplex bridges could not be mounted on the plate at a suitable position. In 1873, the German musicologist Oskar Paul had the chance to study the duplex scale on a new S&S grand piano in Vienna. Consistently, he mentioned only the front part and only octaves as resulting intervals [20]. In contrast to the patent, even S&S's 1872 catalogue indicates that the earliest duplex scale specimen consisted only of the front part on the wrestplank which added octaves to the fundamental notes [21]. The advantages of this solution were that no modification to the plate production was required and the mounting of the front duplex at any time to any grand piano was made possible. After all there is no evidence that the duplex scale was ever manufactured exactly as indicated in the patent, with long resonating sections even in the lower range.

The first major occasion to present the duplex scale to an international audience would have been the Viennese world fair in 1873, but

S&S did not officially participate. Theodore nevertheless presented S&S pianos to members of the jury in order to make them write an approval in the world fair's official report [7].

In December 1874 Ludwig Bösendorfer published a pamphlet in which he criticized Theodore Steinway's invention [20]. He recounted that during the Viennese world fair he received an order to copy the duplex scale according to drawings. It is doubtful whether he had seen one of S&S's grand pianos at all. Curiously he only knew of the rear part as rendered ineffective by weaving felt through the strings. Bösendorfer was sure that a duplex scale would have an audible effect, but in an undesired way, making the piano sound like the damping did not work properly.

Theodore defended himself against Bösendorfer's allegations by publishing a response in which he explained the motivation behind the duplex scale, the way it was supposed to work and its advantages in detail [20]. In this description, the duplex string lengths produce octaves, fifths or thirds. Here, for the first time, a diversification of intervals takes place, yet they are still partial tones to the fundamental.

The passionate debate between Bösendorfer and Theodore caught the Hungarian piano maker Lajos Beregszászy's interest. He reacted to the two articles in his own short pamphlet. As this source is hardly available today, it seems necessary to outline its purpose briefly [22]. Just like Bösendorfer, Beregszászy does not seem to have actually seen an S&S grand piano. He is only commenting on the statements made by Theodore and Bösendorfer and on that basis tries to point out why the duplex scale cannot work as intended, even though "there is hardly anything to criticize about the invention of the double scale, as long as we stay in the field of theory" [22]. Firstly, he continues, a fundamental tone can be enhanced "only by connecting the fundamental directly to a resonator. If this is supposed to work with an object separated from the fundamental, then the resulting resonance would disturb the fundamental" [22]. Beregszászy further claimed that both parts of the duplex scale were insufficient due to the additional string section on the wrestplank being too short. As a result, the frequencies they produce lie outside the perceivable spectrum, whereas the rear section was dampened by felt and thus did not sound at all.

In summary, only from 1875 onwards is the practice of a full front and rear duplex scale documented. In this year, preparations for the so-called centennial grand began, which S&S presented at the Philadelphia world fair in 1876. For this updated flagship model the plate was equipped with some modifications. As part of these activities, a next step in the development of the duplex scale came with the introduction of the capo d'astro bar in 1875 (U.S. patent No. 170,646). This transverse bar replaces the agraffes in the treble range and terminates the

Fig.4

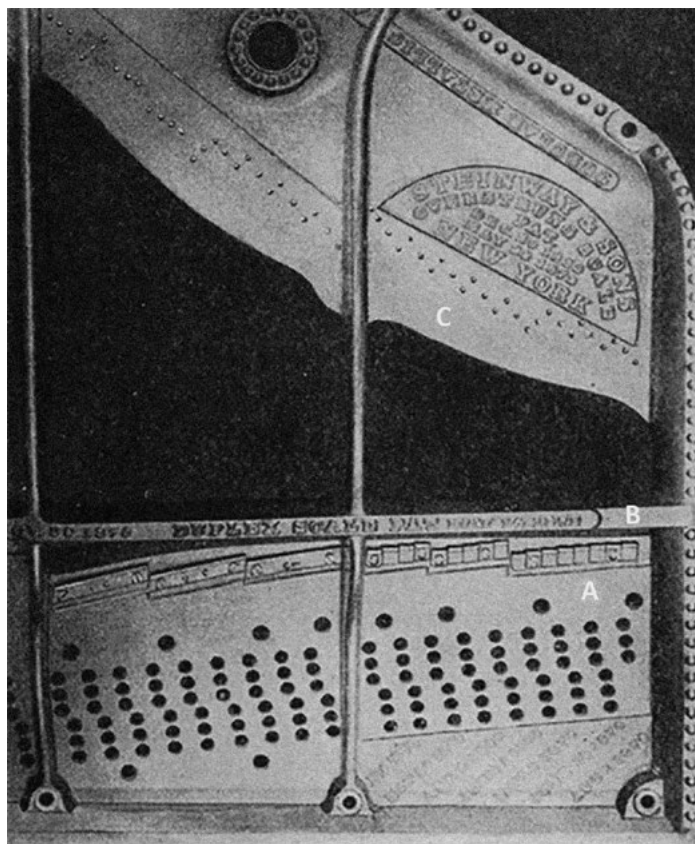

sounding string lengths. An undated contemporary photo (Fig.4, taken before 1892) shows the treble portion of the new iron frame with its typical ornamental rosettes on the outer edge [8].

In Fig.4 letter B marks the new capo d'astro bar. On the hitch pin plate C, the pin holes have been moved away from the outer edge at various distances. The rear duplex bridges are missing in the photo, because they are not cast into the plate. They need to be positioned in front of the hitch pins and by moving them, tuning becomes possible. The wrestplank plate A is equipped with two different types of bearing surfaces for the front duplex: the left plate section contains three diagonal pads, whereas the supports on the right section are individually mensurated for each course. In both versions, the strings run over a metal edge in order to form a clear termination point.

Between 1880 and 1886, when Theodore was back in Braunschweig, he kept on instructing his nephew Henry Ziegler on technical

matters. A series of 26 letters entirely written in German documents these efforts [23]. Several passages in the letters deal with defects of the duplex scale and suggestions for improvement. In 1883, for example, Theodore told his nephew Henry Ziegler: “I have decided on a longer duplex [...] and that works very well. Behind the bridge I take only two sections of the duplex scale; but in the front on the wrestplank three sections” [24]. The most detailed statements date from 1884:

As far as the loud singing of the duplex [scale] is concerned, there is a very simple remedy for those who feel disturbed by it: that is, to weave a ribbon through the duplex. However, the sharp and high tones in the lowest position of the duplex are not caused by the duplex itself. [...] The duplex's length should maintain $2\frac{3}{4}$ inches to $1\frac{1}{2}$ inches as the shortest dimensions, but that is only possible if you use a lot of fourths and then it will hardly last. Right now we have $3\frac{1}{4}$ inches to $1\frac{1}{2}$, but as I said I know that pianos completely without duplex screech like the devil, for instance Blüthner most of all, then Chickering, then Bechstein. So it's not the duplex's fault, especially when there's leather on the bearing surface. [...] Similarly the long duplex scale, that chatter [“schnattern”] should just have a steeper slope and thereby all the small flaws would disappear. So just put wedges under those duplexes [sic] which stick out the most and thus modify the flexibility. If you deal with this issue carefully, it won't be necessary to partition the duplex scale differently and shorter [25].

A few months later Theodore came back to this subject, probably reacting to Henry's response:

Your idea to set the duplex entirely on metal is not bad, but that means you have to exceed the audible frequency range, otherwise the resonating tone would be too disturbing. [...] There is nothing disturbing, viz. between the 36th and 53rd tone, but from this point on the duplex could be shorter. [...] The tone in this area has a virtually tender charm and a special elegance, which unfortunately disappears from the 54th onwards. On the contrary, here the overtone reaches the ear as an individual and that should not be. Only a very short scale on metal would prevent this and the impulse of the string's division would increase, provided that the length is above the audible range [26].

The outer audible limit of approximately 16 kHz is only two octaves above the fundamental frequency of the piano's top note C8 (f_0 for A4 = 440 Hz), but in the patent all the resulting duplex intervals stay clearly below that limit. The use of fourths shows a further diversification of intervals.

These constant changes in the intervals and lengths of the duplex scale illustrate that the company did not strictly reproduce what had been defined in a patent at some point, but that it was common to make adjustments throughout the years.

Fig.4 “Treble Portion of the Iron Frame”, after Fanny Morris Smith, [8, p. 149].

5. Case Study: “Helmholtz Grand”, New York 1871 (ser. no. 21460)

On April 22, 1871, William Steinway departed by steamer for a trip to several European cities, which included a stay in Berlin for a few days. He intended to meet Helmholtz there, but did not succeed (compare [11] or [19, entry on May 25, 1871]). The reason for this visit probably was the new grand piano Helmholtz had just received. Since 2009, this piano is located at Deutsches Museum Munich (ser. no. 21460, hereafter referred to as the “Helmholtz grand”). An entry in S&S’s sales book of 1871 verifies its identity [27]. The piano was sent by steamer from New York to Hamburg on April 17, 1871 and was then transported to Berlin, where Carl Bechstein attended to the tax formalities. On June 23, William noted in his diary: “...call on Bechstein, receive about 5 Thlrs from him after deducting about 20 Thlrs duty for Helmholtz Grand” [19].

After the piano had arrived safely at his home, Helmholtz expressed his gratitude in a letter to Theodore, in which he praised this piano’s “organ-like” duration of tone, the light touch, the precise damping of the split damper pedal and the long bass strings, which made the bass notes more articulate [11]. He further claimed to frequently hear combination tones there and even added a paragraph about his acoustical experiments on this piano in the fourth edition of *On the Sensations of Tone* [1]. No. 21460 is a large concert grand piano with an extended range of 88 keys and a length of 8’5” (260 cm). The rosewood veneer and the carved cabriole legs and lyre contributed to the distinctive appearance of S&S’s grand pianos at that time (see Fig.5).

According to the plate inscriptions, this piano is equipped with cross stringing, agraffes and the iron frame resonator, but there is no mention of the duplex scale. This is due to the fact that the piano was built one year before the duplex scale’s regular implementation. Yet surely the Steinways wanted to show Helmholtz the invention that was connected to his work and hear his opinion. For this purpose, they decided to retrofit the piano “at least as far as possible” [28], so they inserted only the front part on the wrestplank. Theodore himself and a foreman came to Helmholtz’s house in Berlin in July 1873. It took them 6 days to finish their work. Helmholtz documented this procedure in a letter to his wife [28].

This particular front duplex scale in the upper two plate sections has a zig-zag shaped bearing surface (see Fig.5), probably made of hardwood. Despite the overall diagonal outline, each course of three strings runs over an individually mensurated support. Today it is fully covered with roughly cut felt. The strings, hammers and felt pieces in this piano have not been replaced in the recent past.

The results of the new duplex scale were very effective according to Helmholtz: “The highest tones of our piano have really improved; you can still make the difference audible by dampening the cleared string portions. By the way, it is unbelievable what degree of studies and pre-

Fig.5



cision work is put into such a grand piano. Mr Steinway showed me a lot of details in the interior; but I will still propose some changes” [28]. These suggestions might have been included in a letter to the Steinways of August 13, 1873 in which Helmholtz thanked them for the new duplex scale “just applied to my Steinway Grand Piano” [20]. Only a few sentences of this letter were printed in the S&S catalogues and unfortunately the autograph is not extant [10] so that Helmholtz’s ideas about what to improve remain unknown.

The detailed source material regarding the “Helmholtz grand” indicates that S&S themselves used to retrofit the duplex scale even if a piano predated its invention. So far, it is not clear how often that happened. Moreover, this instrument’s duplex scale belongs to the earliest type. This makes it especially valuable for the following measurements.

6. Measurements

6.1. Comparison of Historic Grand Pianos Manufactured Between 1871 and 1884

As an attempt to find alterations which led to the current design, the “Helmholtz grand” is compared to several instruments built after 1871 and before 1885. Instruments of that period are notably difficult to find: they are too young to be exhibited, too old to be treated for general restoration at the factory (which becomes necessary after roughly 100 years) and they are quite unpopular on the second-hand market due to the fact that they mostly have only 85 keys. For the study at hand,

Fig.5 Left: Steinway grand piano (ser. no. 21.460), New York 1871, since 2009 at Deutsches Museum, inv. no. 2009-0477 (Deutsches Museum, München, Archive, CD_L6383-01, reproduced with permission). Right: close-up view of front duplex section in the treble range.

Table 1

Year	Ser. No.	Model	Keys	Front Duplex Keys	Front Duplex Coupling	Rear Duplex Keys	Condition	Ownership
1871	21.460	Style 3	88	52-88	Agraffe	none	unrestored, playable	Deutsches Museum, Munich
1877	35.855	Monitor	85	52-85	Agraffe	46-85	restored, playable	Klangmanufaktur, Hamburg
1877	35.983	C hist.	85	36-85	Agraffe	36-85	unrestored, most keys playable	Klangmanufaktur, Hamburg
1879	42.411	C hist.	85	52-85	Capo D'astro	52-85	unrestored, some keys playable	Klangmanufaktur, Hamburg
1884	51.611	B-211	85	52-85	Capo D'astro	40-85	unrestored, not playable	Klangmanufaktur, Hamburg
1977	454.791	B-211	88	52-88	Capo D'astro	52-88	playable	LMU, Munich

four additional pianos could be examined. Most of them are considered “unrestored”, which only means that no signs of restoration (and/or modification) are visible or known. The state of preservation varied widely: for some notes on the unrestored instruments, the pressed key just about produced a tone or the knock by the key bed contact completely dominated the sound. Some strings lost their tuning with the first played note due to loose tuning pins. On the other hand, one piano from 1877 is restored to the state of a brand new instrument (new action, new strings, and new sanded height profile for the soundboard).

Herein lies a common dilemma in the investigation of historic instruments: their appearance is distorted, either by time or restoration. In this regard, general statements about the vibroacoustic behaviour of the instrument in its past based on current measurements are problematic. Furthermore, the replacement of smaller construction parts complicates an organological evaluation of the development of the duplex construction (e.g., string sections damped with pieces of felt). Nevertheless, careful consideration of measurements and informed correlation of these measurements with available historic data represents the most promising approach to making meaningful assumptions about construction decisions made over a century ago.

Table 1 Overview for the examined pianos, including the “Helmholtz grand” and a modern model B.

A modern S&S model B is examined to compare obtained historic data to the present norm. See **Table 1** for a detailed classification of the instruments under study.

6.2. Scale Measurements

For the modern rear duplex scale, large deviations from the nominal harmonic relations are found (50 cent average) as well as within trichords (25 cent average) [13, 16]. Öberg and Askenfelt assume, “that the authors of the Steinway patent were aware of that accurate tuning to the nominal frequency relations is not of critical importance for the perception” [16]. This is in contrast to Theodore’s reasoning about the need for precise mensuration of the harmonic relations between main and duplex string to obtain the desired effect [3, 20].

For the modern front duplex, trichords are largely mistuned (70 cent average) due to the pressure bar running at an angle with the capo d’astro bar and nominal relations to the main strings vary widely [16]. The modern implementation also does not allow the tuner to adjust the string length relations. Again, this contradicts statements by Theodore who praises the duplex mechanism as to give the tuner control over this part of the string [20].

For all examined instruments the following parameters are measured: the lengths of all string parts (using steel rulers) and the angle from the main string to the front duplex string (using a digital goniometer). Since for all historic pianos the front duplex plate is realized in a staircase shape (from key to key), all trichord strings have the same length. The front duplex string lengths per trichord for the modern grand are measured separately. For specification of the nominal front duplex intervals, the average length per trichord is used.

Fig.6 depicts the measured nominal front duplex intervals per piano and key. The light lines illustrate the intervals proposed by the patent. The “Helmholtz grand” is the only piano to precisely follow the patented intervals. The front duplex is realized down to C5. The Monitor, built six years later, still follows the specification of using only single and multiple octaves but later jumps to lower intervals. The serial number of the second piano from 1877 indicates that it was built shortly after the first, but it is a different model (C hist.). It is the only instrument to have the front duplex realized down to G3 and does not follow the patent over most of the course. Instead, intervals between the octaves are utilized. Built two years later, another historic C utilizes intervals between octaves for most of the keys down to C5. Built five years later, a B-211 manufactured in Hamburg only matches the double octave for a few keys between G5 and B5 and otherwise uses fifths, twelfths and higher intervals between the integral multiples

Fig.6

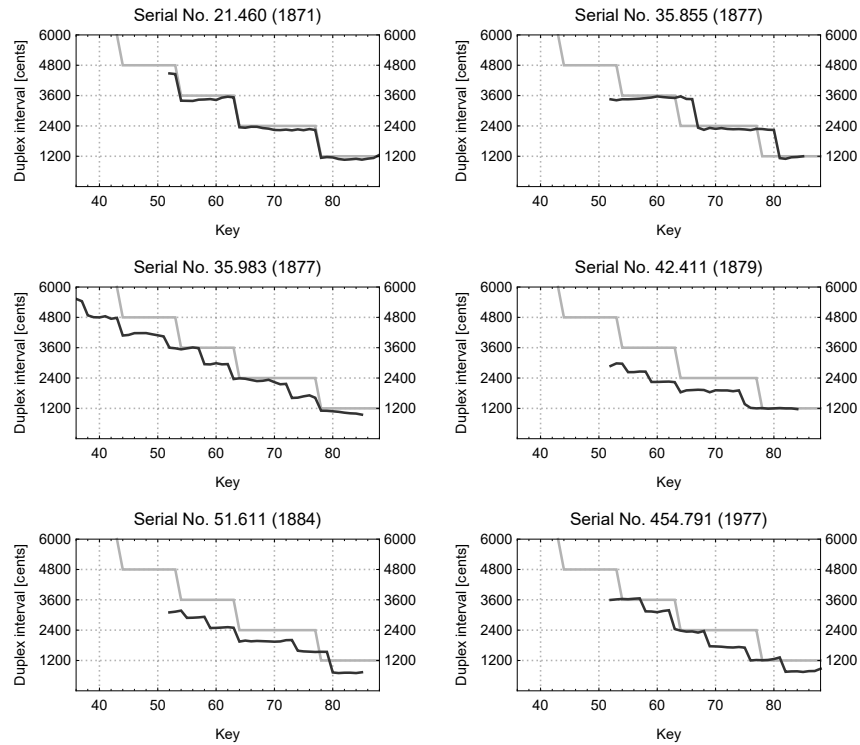

of octaves. For the modern B-211, nominal intervals (apart from the large deviations due to the duplex plate design) go up to the triple octave and it uses one interval between each two integral multiples of the octaves.

Fig.7 illustrates the nominal rear duplex intervals per piano and key. The light lines depict the intervals proposed by the patent. As discussed in section 5, the “Helmholtz grand” does not have a realized rear duplex mechanism. In general, no examined instrument follows the design proposed by the patent. For the Monitor from 1877, the rear duplex is realized down to C5 utilizing octaves, twelfths and double octaves. The model C from the same year has a rear duplex down to G3, very roughly following octaves and double octaves. The model C two years later has a rear duplex down to C5, again forming the same intervals but having more keys in higher relations. The B-211 from 1884 has a rear duplex down to C4 and is the only instrument with rear duplex intervals higher than the double octave. For the modern grand, rear duplex intervals of octave, approximate thirteenth and double octave are realized.

Fig.6 Nominal front duplex intervals as implemented (dark) compared to what is specified in the patent (light).

Fig.7

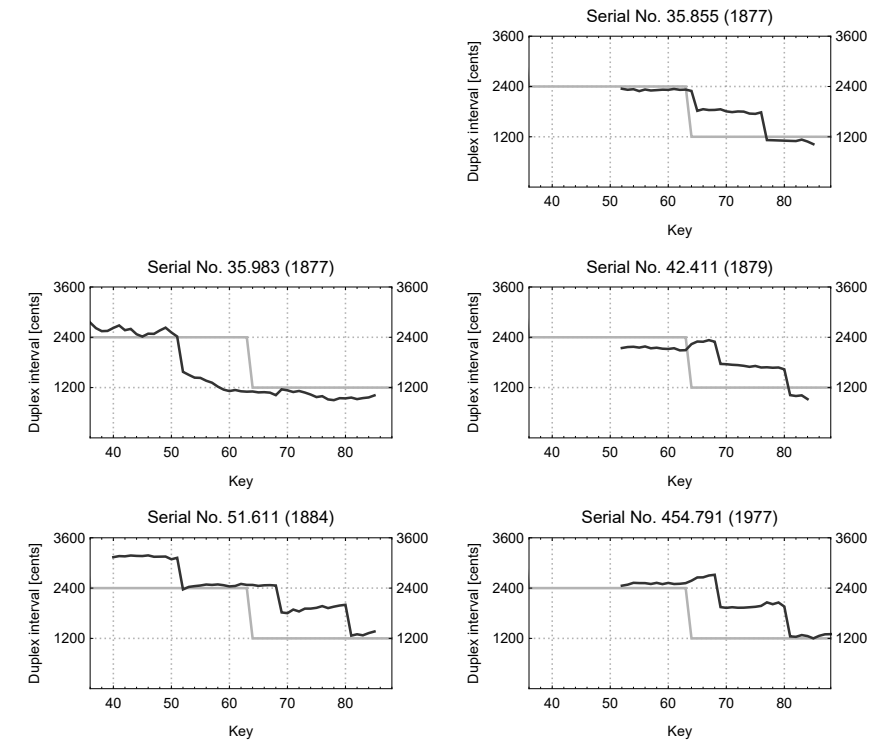
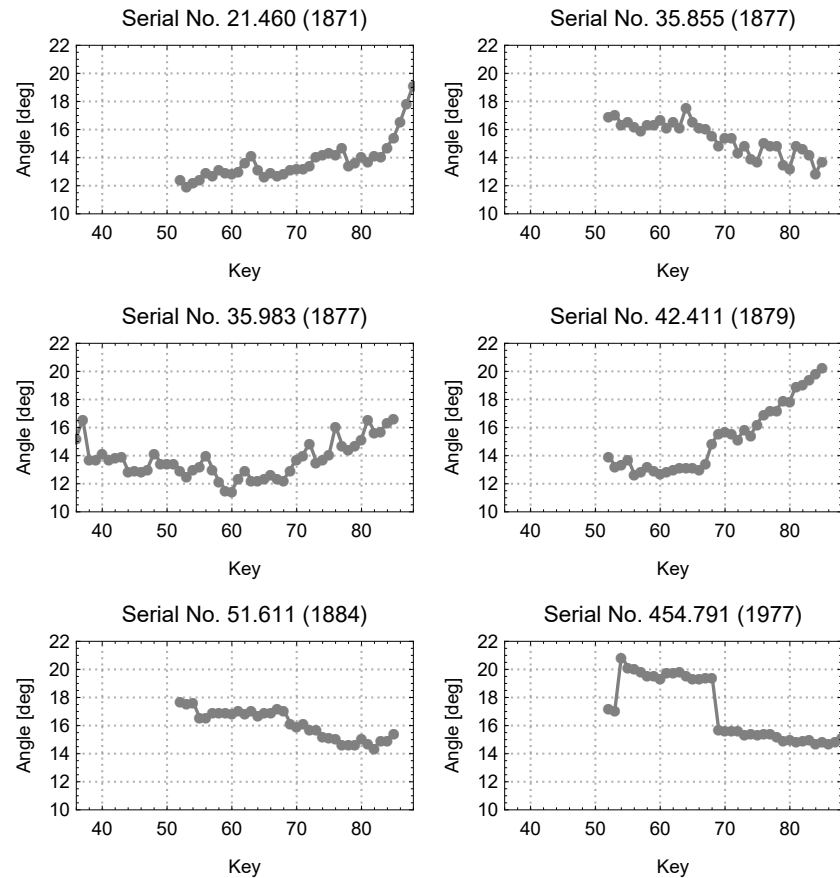

Fig.8 illustrates the angles between the main string and the front duplex string per piano and key. In general, earlier instruments seem to have a sharp increase of angle in the high treble range (with the highest gradient for the “Helmholtz grand”). The Monitor from 1877 as an outlier has been restored and thereby brought to a design comparable with current manufacturing.

For all pianos before implementation of the capo d’astro bar, the front duplex plate is covered with felt. As a consequence, the front duplex strings do not end point-like but run into a bed of felt. For the two historic pianos with capo d’astro bar, the front duplex string terminates on a small metal block with indentations for each string, thus yield to a point-like fixed boundary condition (as implemented in the current design). Note that the two instruments from 1877 (ser. no. 35.855 and ser. no. 35.983) have little separate metal blocks defining the string termination on the frame. These can be shifted to tune the rear duplex trichord by trichord.

Fig.7 Nominal rear duplex intervals as implemented (dark) compared to that specified in the patent (light).

Fig.8



6.3. Vibroacoustic Measurements

Due to the fact that the pianos were situated in very differently shaped rooms with, in part, high reverberation times, the obtained radiation measurements are not considered for the analysis. The presented data, therefore, is solely based on acceleration measurements at the string/bridge termination points perpendicular to the soundboard (piezoelectric transducer model: PCB 352C23). The rear duplex strings are damped for all measurements. For all playable instruments, the keys with a front duplex are played by hand in forte range (finger stays on key before strike). If playable, the instruments were tuned before the measurements. Ten takes for each key are recorded. All recordings are performed with 48 kHz and 16 bit resolution.

Since the spectral content of a piano tone is highly dependent on the acceleration of the key, a mechanical finger would have been

Fig.8 Angle from main string to front duplex string per key and piano.

Fig.9

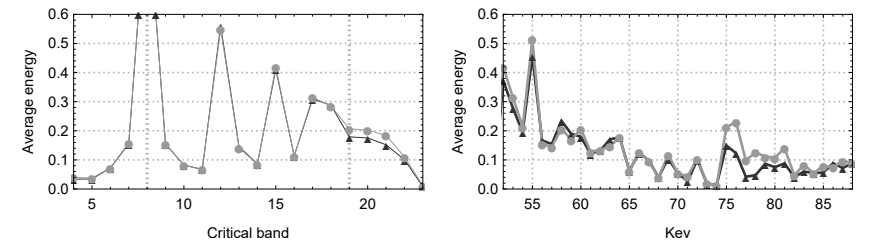

preferable to ensure a constant key-pressing force in all measurements. Unfortunately, such a device could not be used for the study at hand. Therefore, the 10 x 10 takes are filtered regarding the combination with minimum difference of amplitudes of the first string displacement approaching at the bridge. Since no interaction with the front string termination has happened for the first pulse, it should be unaffected by the duplex mechanism. This process reduces data to 1 x 1 per key but thereby diminishes the error effected by variance of played dynamics. Even though the pitch of a piano tone is considered to change over the span of the decay, for FFT-based analysis a fixed 1s-window with Hamming window function is used starting after the initial transient phase. For the main strings f_0 is estimated by a peak detection. The corresponding frequency band is derived based on the measured chamber pitch and following the Railsback curve [29]. The inharmonicity coefficient (B) is estimated for each string by iterating a peak detection for increasing partial numbers and adjusting B consecutively [30].

For all notes the average energy per critical band is calculated [31]. As described in section 3, application of the duplex schematic firstly enhances higher partials of the produced tone and secondly prolongs their decay. To detect enhanced higher partials in the bridge motion, the average energy in the frequency band containing $f_{0duplex}$ is compared to the band containing f_{0main} . $f_{0duplex}$ is not measured but estimated, assuming the same tension for the duplex part as for the main string part. Fig.9 exemplarily illustrates the effect of the front duplex scale for a modern grand. Average energy in the bands around $f_{0duplex}$ is slightly increased.

The Monitor from 1877 shows the greatest average increase in critical band energy when undamped. This can be explained by the fact that this instrument had just been restored a few weeks before measurements with the focus of enhancing the duplex effect (the felt was removed from the duplex plate and the front duplex plate was sharpened

Fig.9 Left, Average bridge acceleration per critical band for damped (triangle) and undamped (circle) front duplex. Key 60 (G5/A5) on a modern model B, forte played. Vertical dashed lines denote bands containing f_{0main} and $f_{0duplex}$; Right, Average energy ratio for the same piano for all keys.

to form a point-like string termination). The modern model B shows the second greatest average increase of band energy. The historic C from 1879 has the third greatest increase of average energy, which happens to be the first one with a capo d'astro bar. The "Helmholtz grand" and the historic C from 1877 show no significant increase in duplex band energy when undamped.

7. Conclusions

Even though an active contribution of Helmholtz to the invention or even a close collaboration with Theodore Steinway could not be observed, the duplex scale seems to be highly influenced by his findings. The construction was patented in May 1872 and is regularly realized for grand pianos from ser. no. 25.000 on. The case study of the "Helmholtz grand" showed that it was possible to retrofit older pianos with the duplex mechanism.

In the earliest phase up to 1875, the grand pianos follow the nominal front duplex intervals proposed by the patent, which is never the case on later instruments known to the authors. In these instruments, only octaves appear as resulting intervals. Over time, a gradual diversification of intervals takes place: at first they correspond to the harmonic series (octaves, fifths and thirds), and later, indefinite intervals are realized. Thus, the theory and practice of the duplex scale diverged increasingly.

Little variation is observable over the selection of instruments in regard to the range of the compass, to which the duplex scales have been applied. As an outlier, the historic model C from 1877 has the greatest range. Again, no instrument follows the range proposed in the patent, where the rear duplex scale covers most of the compass.

The issue of the duplex scale's tunability was subject to criticism from the beginning, as the possibility to control the duplex string length was an important part of Theodore's reasoning for the value of the invention. Two of the instruments studied (and a frame depicted in **Fig. 4**, dating from before 1892) have little, separate metal blocks for the rear duplex string termination. By shifting these blocks, the tuner could adjust the length ratio from rear duplex string to main string. However, in later instruments, the separate blocks are replaced by a single metal band fixated on the frame.

In summary, precisely mensurated intervals turn out not to be decisive factors in the functionality of the duplex scale. Instead, several other factors could have an impact on the working mechanism: up to the implementation of the capo d'astro bar, all considered historic pianos have their front duplex plate fully covered with felt. This is mentioned neither in the patent nor in other known historic sources. The instruments with capo d'astro bar have a point-like front duplex

string termination. Earlier instruments seem to have a sharp increase of angle in the high treble range (with the highest gradient for the "Helmholtz grand") in contrast to a more homogenous progression of angles for the current model. All considered historic instruments have a staircase-shaped front duplex plate which ensures the single strings in a trichord to be of the same length. This is consistent with statements by Theodore, but contrary to the front duplex design currently applied by S&S.

As a result of the vibroacoustic measurements, the duplex effect in the bridge motion is most pronounced for the Monitor grand from 1877. This could be explained by the fact that it has been recently restored. The influence of the duplex mechanism is lower for the modern B-211 and for the historic C from 1879. No significant effect is measurable for either the "Helmholtz grand" or the historic C from 1877.

The previous observations can only sketch certain tendencies; nevertheless, the extent of constructional modifications over the first twenty years indicates that the duplex mechanism did not work as intended from the beginning. In this regard, the development could be understood as the implementation of a highly theoretical concept which was then refined through a trial-and-error approach.

ACKNOWLEDGEMENTS: The authors would like to thank Klangmanufaktur Hamburg, the Institute of Musicology at Ludwig-Maximilians-Universität Munich and the Deutsches Museum Munich for the opportunity to perform measurements on their instruments, and the Centrum Baustoffe und Materialprüfung at the Technical University of Munich for providing measurement devices. Silke Berdux, Rebecca Wolf and Laurence Libin have helped with advice and instructive conversations.

Katharina Preller's work as member of the research group "Materiality of Musical Instruments: New Approaches to a Cultural History of Organology" is funded by the Leibniz Association (SAW-2016-DM-4). Niko Plath received a scholarship from the same research group at Deutsches Museum.

References

- [1] H. von Helmholtz, *On the Sensations of Tone* (repub. of 1854 2nd edition). (n.p.): Dover Pub., 1954.
- [2] E. F. Hiebert, "Helmholtz's musical acoustics: Incentive for practical techniques in pedaling and touch at the piano," in *The Past in the Present. Proc. IMS Intercong. Symp. and 10th Meeting of Cantus Planus*, Budapest, & Visegrád, Vol. 1, pp. 425-443.
- [3] C. F. T. Steinway, *U.S. Patent No. 126,848. Improvement in Duplex Agraffe Scales for Piano-Fortes*. Washington D.C.: U.S. Patent and Trademark Office, 1872.
- [4] P. Poletti, "Steinway and the invention of the overstrung grand piano frame," in *Matière et musique: The Cluny Encounter, Proc. European Encounter on Instrument Making and Restoration*, Labo 19, pp. 241-263.
- [5] R. F. Kehl and D. R. Kirkland, *The Official Guide to Steinway Pianos*. Milwaukee: Amadeus Press, 2011.
- [6] A. Dolge, *Pianos and Their Makers*. Covina: Covina Publishing Company, 2011.
- [7] E. M. Good, *Giraffes, Black Dragons, and Other Pianos*. Stanford: Stanford University Press, 1982.
- [8] F. Morris Smith, *A Noble Art: Three Lectures on the Evolution and Construction of the Piano*. New York: De Vinne Press, 1892.
- [9] Steinway & Sons, Eds., *Illustrated Pamphlet on the Founding and Development of Steinway, N.Y. (Longs Island City)*. Date unknown. Available: http://americanhistory.si.edu/steinwaydiary/gallery/?category_id=1. Accessed on: July 7 2018.
- [10] E. and E. Hiebert, "Musical thought and practice: Links to Helmholtz's Tonempfindungen," in *Universalgenie Helmholtz. Rückblick nach 100 Jahren*. Berlin: Akademie Verlag, 1994, pp. 295-311.
- [11] H. von Helmholtz, Letter to Theodore Steinway, June 9, 1871. New York, NY, La Guardia and Wagner Archives, Steinway & Sons Collection, Box 040260, Folder 67, Letter 001.
- [12] H. A. Conklin, Jr., "Design and tone in the mechanoacoustic piano. Part III. Piano strings and scale design," *J. Acoust. Soc. Am.*, vol. 100, no. 3, pp. 1286-298, 1996. doi: [org/10.1121/1.416017](https://doi.org/10.1121/1.416017)
- [13] A. Askenfelt and E. V. Jansson, "From touch to string vibrations. III: String motion and spectra," *J. Acoust. Soc. Am.*, vol. 93, no. 4, pp. 2181-2196, 1993. doi: [org/10.1121/1.406680](https://doi.org/10.1121/1.406680)
- [14] J. Cuenca and R. Causse, "Three-dimensional interaction between strings, bridge and soundboard in modern piano's treble range," *Proc. 19th Int. Cong. on Acoustics*, Madrid, 2007.
- [15] P. Zelmar and R. Causse, "Experimental and theoretical study of the vibration of strings in the high register of the piano the effect of the 'Duplex Scale,'" *Proc. 19th Int. Cong. on Acoustics*. Spain, 2007.
- [16] F. Öberg, "Acoustical and perceptual influence of duplex stringing," Ph.D. dissertation, Royal Institute of Technology, Stockholm, 2009.
- [17] F. Öberg and A. Askenfelt, (2012). "Acoustical and perceptual influence of duplex stringing in grand pianos. *J. Acoust. Soc. Am.*, vol. 131, no. 1, pp. 856-871, 2012. doi: [org/10.1121/1.3664049](https://doi.org/10.1121/1.3664049)
- [18] F. Pfeifle, "Acoustical properties of the front-duplex system in a grand piano," *J. Acoust. Soc. Am.*, vol. 14, no. 4, p. 3318, 2016. doi: [org/10.1121/1.4970569](https://doi.org/10.1121/1.4970569)
- [19] National Museum of American History, *The William Steinway Diary Project, 1861-1896*. [Online]. Available: <http://americanhistory.si.edu/steinwaydiary/> Accessed on: July 7, 2018.
- [20] C. F. T. Steinway, "Duplex Scala (Doppelte Mensur), Patent No. 126848 vom 14 May 1872 und Herr Bösendorfer in Wien" in *Signale für die musikalische Welt*, vol. 33, pp. 72-79, 1875.
- [21] *Illustr. Cat. of Steinway & Sons' Pianos*, New York, NY, 1872. La Guardia and Wagner Archives, Steinway & Sons Collection, Box 040005, Folder 6 (orig. in German, own translation).
- [22] L. Beregszászy, *Die Steinway'sche Doppelmensur im Lichte der Praxis*. Budapest: Khór & Wein, 1875 (orig. in German, own translation).
- [23] T. Steinway, Letters to Henry Ziegler, 1880-1886. New York, NY, La Guardia and Wagner Archives, Steinway & Sons Collection, Box 040260, Folder 024.
- [24] T. Steinway, Letter to Henry Ziegler, May 17, 1883. La Guardia and Wagner Archives, Steinway & Sons Collection, Box 040260, Folder 024, Letter 015 (orig. in German, own translation).
- [25] T. Steinway, Letter to Henry Ziegler, July 5, 1884. La Guardia and Wagner Archives, Steinway & Sons Collection, Box 040260, Folder 024, Letter 018 (orig. in German, own translation).
- [26] T. Steinway, Letter to Henry Ziegler, November 17, 1884. La Guardia and Wagner Archives, Steinway & Sons Collection, Box 040260, Folder 024, Letter 019 (orig. in German, own translation).
- [27] *Sales Book, 1869-1871*. New York, NY, La Guardia and Wagner Archives, Steinway & Sons Collection, Box 040330.
- [28] E. von Siemens-Helmholtz, Ed. *Anna von Helmholtz. Ein Lebensbild in Briefen*, vol. 1. Berlin: Verlag für Kulturpolitik, 1929. (orig. in German, own translation).
- [29] O. L. Railsback, "Scale temperament as applied to piano tuning," *J. Acoust. Soc. Am.*, vol. 9, no. 3, p. 274, 1938. doi: [org/10.1121/1.1902056](https://doi.org/10.1121/1.1902056)
- [30] H. Fletcher, "Errata: Normal vibration frequencies of a stiff piano string," *J. Acoust. Soc. Am.*, vol. 36, no. 6, pp. 1214-1215, 1964. doi: [org/10.1121/1.1919187](https://doi.org/10.1121/1.1919187)
- [31] H. Fastl and E. Zwicker, *Psychoacoustics: Facts and Models*. Berlin: Springer, 2007. doi: [org/10.1007/978-3-540-68888-4](https://doi.org/10.1007/978-3-540-68888-4)

A Synergy of Form, Function and Fashion in the Manufacture of the Erard Harp

PANAGIOTIS POULOPOULOS (1), JULIN LEE (2)

(1) Research Institute for the History of Science and Technology,
Deutsches Museum, Munich, Germany

(2) Institute for Musicology, Ludwig Maximilian University, Munich, Germany

Abstract

The name of Sébastien Erard (1752-1831) is synonymous with the development of the modern harp and piano. In the case of the harp, Erard not only played a major role in the technical, acoustical and visual transformation of the instrument, but also revolutionised the harp industry in general. Particularly with the introduction of the double-action harp in London in 1811, Erard pioneered new manufacturing and marketing standards, establishing a business model that was imitated by his contemporaries and competitors. This article presents new insights on the manufacture of the Erard harp, focusing on the transition from the single- to the double-action harp. By combining the results of object-based and archival research, the article will discuss Erard's production strategies and workshop practices, highlighting aspects of standardisation, serial numbering and trademarking, analysed especially within the wider context of the evolving musical instrument trade during the early nineteenth century.

1. Introduction

Until the third quarter of the eighteenth century, the pedal harp, an instrument most likely developed in Bavaria during the 1720s, played a minor, marginal role in European musical life. However, by 1800, within less than a century from after its conception by Jakob Hochbrucker (1673-1763) of Donauwörth [1], the pedal harp had been firmly established across Europe as a novel, fashionable instrument which strongly rivalled the popularity of the pianoforte among professional and amateur musicians.

This was largely the result of a radical technical, musical and aesthetic upgrade of the single-action harp, the earliest type of pedal harp which allowed for the shortening of each string by a semitone using L-shaped hooks (crochets). The race for the improvement of the single-action harp, which began in France during the late eighteenth century with harp makers such as Georges Cousineau (1733-1800) or Jean-Henri Nadermann (1734-1799), reached its peak in Regency London with the introduction of the double-action harp by Sébastien Erard (1752-1831) in 1811. Erard's new harp possessed increased range and potential for virtuosity, since it permitted two additional semitones per string to be produced using a mechanism with small forked discs (fourchettes) [2]. Erard had already been producing single-action harps, along with various keyboard instruments, in Paris since the late 1780s. However, it was while working in the English capital, where he had moved to in the early 1790s, that he concentrated on optimising the design, function and appearance of the pedal harp, as reflected in the five patents he was granted between 1794 and 1810 [3]. With its state-of-the-art mechanism, the double-action harp was capable of playing in all keys, raising the standards of both harp manufacture and harp performance. Through Erard's persistent marketing and international networking, the double-action harp became rapidly successful in England and abroad, eventually securing its place in the modern orchestra.

The transition from the single- to the double-action harp, spanning the three decades from the 1790s to the 1810s, is arguably the most crucial era in the history of the Erard harp, and of the pedal harp in general. This transformational process, which was the fruit of not only long experimentation but also meticulous business planning, had its roots in the Paris branch of the Erard firm, but intensified substantially at Erard's London branch, which during this time was set up exclusively for building harps. However, despite recent publications which have shed new light on Erard's biography and professional activities, and on the firm's operation on a global scale [4, 5, 6], this transitional phase in the development of the Erard harp had not been documented in detail until now. Moreover, there are still many questions to be answered, particularly concerning Erard's production strategies and workshop practices. For instance, how did the collaboration and

transfer of styles and technologies between different artisanal crafts influence the development of the Erard harp? In what ways does the Erard harp reflect aspects of industrial production, such as standardisation, serial numbering and trademarking? How did the firm cope with the growing yet fluctuating demand for harps and ultimately dominate the harp market in London?

2. Research Material, Methodology and Aims

The evolution of the Erard harp in London, from the early single-action instruments of the 1790s to the introduction and gradual establishment of the double-action harp in the 1810s, can be traced by investigating three main sources of information concerning the Erard London branch during this significant period.

The first source is the surviving Erard London Harp Ledgers held at the Royal College of Music, London (Special Collections, RCM 497) [7]. Comprising three books, these ledgers contain important information on the manufacture and sale of Erard harps made in London from c.1798 to c.1917. Additionally, the first book includes Erard's workshop accounts from 1807 to 1809, listing expenses for raw materials, tools and supplies, as well as payments for work carried out in the firm's premises or by subcontractors.

The second source is the surviving correspondence between Sébastien Erard and his nephew, Pierre Erard (1794-1855), owned by the AXA insurance group and deposited with other Erard archival material at the Centre Sébastien Erard – Association Ad Libitum in Etobon, France. The extant letters, which have now been digitised, transcribed and translated [4], were written chiefly by Pierre and span the years from 1814, when he was put in charge of the London branch after his uncle Sébastien had moved to Paris, to 1831, when Sébastien died. Although these two sources have been discussed at length by scholars [4, 5], several details remain open to new analysis and interpretation.

Finally, the third and far less exploited source of information is the large number of surviving Erard harps housed in public and private collections around the world. Using surviving artefacts as primary evidence, which is a traditional methodological concept of organology, also corresponds to the latest shift among various academic disciplines towards material culture [8, 9, 10, 11]. In this case, the study of Erard harps can greatly help to corroborate the results of archival research with the aim of providing a comprehensive chronological account of the Erard harp, and the Erard London branch in particular, during the formative years before and after the arrival of the double-action harp.

For the purposes of this article, a corpus of 3 early single-action Erard harps made in Paris between c.1790, as well as 3 single- and 13

double-action Erard harps made in London from the late 1790s to the early 1830s, were selected (see Appendix). These harps were examined and documented *in situ* as part of the ongoing research project “A Creative Triangle of Mechanics, Acoustics and Aesthetics: The Early Pedal Harp (1780-1830) as a Symbol of Innovative Transformation”, funded by the Volkswagen Foundation and hosted at the Research Institute for the History of Science and Technology in the Deutsches Museum, Munich [12].

The material collected from the *in situ* investigation of the above mentioned Erard harps was compared to and complemented with data from harps by Erard and other makers which have been described and depicted in scholarly articles and books [13, 14, 15, 16], in academic dissertations [17, 18, 19, 20], in exhibition and auction catalogues [21, 22, 23, 24], in conference proceedings [25], in dictionaries [26], in museum checklists and internet websites [27], and in conservation and restoration reports [28]. Regardless of the varying levels of accuracy and depth, these secondary sources are valuable research tools for studying Erard harps. Nevertheless, it is pertinent to point out that in some cases the provided information may be limited, outdated, or incomplete, if not incorrect, and consequently such sources need to be treated with caution. Moreover, several of these harps have been extensively repaired, restored or modified in the past, and may thus not retain their original features, a fact which, if overlooked, can lead to wrong conclusions [29].

By considering the aforementioned object-based and archival resources, a concise summary of the development of the Erard harp from the 1790s to the 1810s, focusing on aspects of design, construction and decoration, is presented in the following section.

3. The Development of the Erard Harp

3.1 The Early Erard Harp

As previously mentioned, the earliest surviving harps by Erard were built in Paris and date from the late 1780s to the early 1790s [Fig.1]. These harps typically have a height of 1670 mm, a maximum width of 355 mm at the bottom of the soundboard, and a maximum depth of 750 mm from capital to shoulder. The soundboard, with a length of 1165 mm, consists of several pieces of wood, usually spruce, glued together, with their grain perpendicular to the bridge in the middle, and has no soundholes. The soundbox is made of seven maple staves, evoking the body of a lute. The column, with a tapering diameter of 49 to 54 mm from the bottom of the capital to the top of the base, is ornamented with gilded wood carvings on its top and bottom, and is carved in the middle section with 14 flutes. The neck forms a shallow S-shaped curve from capital to shoulder and has a thickness of 50 mm.

Fig.1

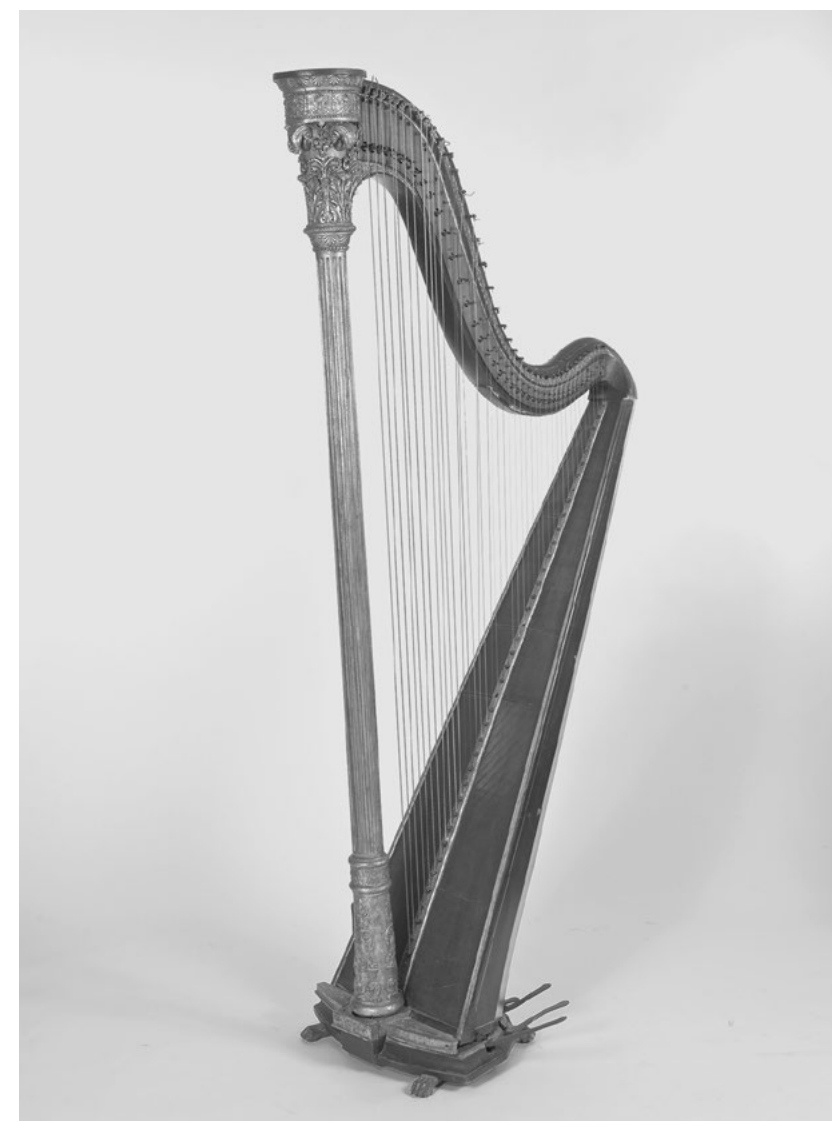

Early Paris-made Erard harps usually have 39 or 40 strings with a fourchette mechanism enclosed in the wooden neck. On the earliest of these harps, the fourchettes are hidden inside a brass plate, with only their protruding pins being visible, while on later specimens the fourchettes are fully exposed; in both cases the back of the mechanism

Fig.1 Early single-action harp by Erard, built in Paris c.1790 and bearing no serial number, in the Muziekinstrumentenmuseum, Brussels, Inv. No. JT0005 (© MIM/RMAH, Brussels, reproduced with permission).

is covered with a wooden panel screwed on the neck. The strings, which are secured with wooden pins on the bridge and also tied on metal tuning pins on the top of the neck, are further stretched on an intermediate row of immovable nuts fixed on the brass plate. These nuts determine the vibrating string length of the open strings, while their distance from the fourchettes provides the length required to achieve the higher semitone per string when a pedal is pressed. Each of the seven pedals comprises has two interlinked levers and is attached on a metal frame screwed to the bottom of the soundbox. On some of these harps there are five shutters activated with an additional eighth pedal to allow for subtle changes in dynamics, an invention of the harpist Jean-Baptiste Krumpholz (1742-1790) and the harp-maker Nadermann from c.1785 [14]. The shallow pedalbox, with a height of 50 mm, is attached to the soundbox with three large screws and has a small round hole at its bottom to allow access for slight adjustments to the pedal mechanism.

In terms of design and construction, these instruments essentially resemble the French harps made in the late eighteenth century, but with some notable differences. For instance, the top of the column on early Erard harps has the form of a capital instead of a scroll, a shape typically associated with the Baroque style and widely used on French harps. Moreover, instead of the usual crochets, the pedal mechanism operates with the more advanced fourchettes, eliminating problems of string misalignment and breakage. Additionally, there are no soundholes on the soundboard, perhaps to avoid weakening the wood. Furthermore, apart from the gilded carved ornaments on the column and pedalbox, these harps are generally plain, without the elaborate painted embellishments often found on earlier French harps. Interestingly, although the name and address of Erard is engraved on the brass plate covering the fourchette mechanism (“Erard frères à Paris // Rue du Maille No. 37”), none of these early Paris-made Erard harps, of which seven are presently known [28], bear a visible serial number. However, it is worth noting that several wooden and metal parts on these instruments are stamped, engraved or inscribed with Latin or Arabic numerals, similar to those found on Erard pianos produced in Paris around the same time, most likely to assist the assembly of the various instrument parts.

3.2 The Single-Action Empire Model

In contrast to the early Erard harps described above, which were made in Paris c.1790, the earliest surviving harps by Erard made in London date from c.1798. By that time, Erard’s London branch had started building single-action harps based on Erard’s 1794 patent (British Patent No. 2016), in which he officially presented his new mechanism with

fourchettes that replaced the older crochets system. Commonly referred to as the “Empire” model in relation to the Empire style prevalent in Europe during the Napoleonic Wars from about 1800 to 1815, Erard’s updated single-action harp [Fig.2] signalled a clear departure from the older French harps, as well as from Erard’s early Paris-made instruments, introducing several novel characteristics and paving the way for the advent of the double-action harp.

With the Empire model, the overall size and dimensions of various individual components of the Erard harp increased considerably. Erard’s Empire harps typically have a height of 1700 mm, a maximum width of 360 mm at the bottom of the soundboard, and a maximum depth of 830 mm from capital to shoulder. The range was also extended, since these harps usually have 41 to 43 strings. Furthermore, the construction of the harp was strengthened in order to withstand not only the higher number of strings, but also the added string tension due to changes in the string materials and gauges used from the end of the eighteenth century onwards. The soundboard on Erard’s Empire harps, with a length of 1200 mm, is up to 2 mm thicker than the soundboard of earlier French harps, especially on the bass register. In addition, the Empire model demonstrates one of Erard’s major contributions to harp design: the construction of the soundbox from laminated wood, usually maple, in a round form with horizontal and vertical internal bracing, permanently abandoning the staved design of earlier French harps. This change had a strong impact on the vibroacoustic behaviour of the Erard harp. Compared, for instance, to the harps by Cousineau, typically built with thin soundboards and staved soundboxes, Erard’s harps with thicker soundboards and round soundboxes show more rigidity and consequently less mobility [30], thus losing to a certain extent responsiveness and brightness, but having a fuller sound with more power on the bass and being better adapted to the progressively greater mechanical stress.

Apart from the round soundbox, there were further developments affecting the silhouette of Erard’s Empire harps, easily noticeable when viewed side-by-side with earlier harps by Erard or other makers. One development can be observed on the neck profile, which has a deeper, more pronounced curve in the middle towards the treble strings, corresponding to the gradual rise of pitch during the late eighteenth and early nineteenth centuries [31]. Another development concerns the pedalbox, which, measuring 85 mm, is higher than on earlier harps to allow more room for the new type of single-arm pedals introduced around 1803 [31]. Moreover, the column is slightly thicker than on early Erard harps, with a tapering diameter of 53 to 58 mm from the bottom of the capital to the top of the base, and is carved in the middle section with 12 flutes.

Fig.2



At the same time, Erard took several measures to improve the tuning stability, intonation and functionality of the single-action harp. For example, the entire fourchette mechanism on Erard's Empire harps is enclosed between two brass plates and is mounted on the bottom of the neck with screws. On the one hand, this rendered the functioning components independent from the wooden neck, which is quite sensitive to mechanical stress as well as prone to shrinking or cracking from fluctuations in temperature

Fig.2 Typical single-action harp of the Empire model by Erard, built in London in 1800 and bearing the serial number No. 333, in the Royal College of Music Museum, London, Inv. No. RCM 298 (© Royal College of Music /ArenaPAL, London, reproduced with permission).

and humidity. On the other hand, this facilitated later repairs or replacements without interventions that could damage the wooden structure. The slender neck, which is 35 mm thick, is made from several pieces of wood glued together rather than from a single piece carved into shape. Moreover, the strings on Erard's Empire harps are stretched on a row of sliding adjustable nuts which enable the regulation of intonation. This feature had already been employed from the mid-1780s on Cousineau's harps with a mechanism that utilised a system of crutches (*béquilles*) [32], above which movable nuts could be adjusted using a watch-key, similar to the tuning mechanism often found on citterns, such as English guitars and French cistres from the late eighteenth century. It is noteworthy that Erard's 1794 patent includes movable nuts adjusted with a long vertical screw very similar to those of Cousineau. However, on Erard's surviving Empire harps these nuts are attached more robustly with two horizontal screws and their position can be adjusted using a screwdriver with a slotted head. There are usually no fourchettes or adjustable nuts on the top two or three treble strings near the harp's shoulder.

Equally innovative was the decoration of Erard's London-made Empire harps, strongly influenced by new trends and methods applied in furniture, architecture and interior design. The most common finish of these harps was a glossy black coating with thin gilt lines on the soundbox, soundboard, neck and top of the capital, reminiscent of the black japanned furniture that was quite popular in contemporary households. This is confirmed not only by inspecting the finish on extant Erard harps and those listed in the Erard London ledgers, but also by the fact that no other pigment except for ivory black is mentioned in Erard's London workshop accounts between 1807 and 1809. The column and pedalbox were usually decorated with alternating stripes of black coating and gilding on the fluted areas. On some early Empire harps by Erard the soundboard was painted with colourful floral and geometrical motifs, not unlike those on French harps from the eighteenth century. However, from about 1800, the soundboard and shutters of Erard's Empire harps were typically adorned with gilt red "Etruscan" borders and figures using decoupage, a technique involving printed and gilded paper which could be cut and pasted directly on wooden surfaces [19].

The motives behind this choice regarding the two-dimensional decoration of Erard harps were as much stylistic as they were financial. By the early nineteenth century Neoclassicism dominated the European art, fashion and lifestyle, and even newly invented, state-of-the-art devices, ranging from clocks to steam engines, were often "dressed" in antique Greco-Roman styles [33]. Musical instruments were no exception, and the black-red/gold Erard harps from this time resemble the ancient black-red pottery excavated

in south Italy and Greece during the late eighteenth century, which had become widely known through publications and exhibitions, often labelled as “Etruscan”. From a financial perspective, decoupage was much cheaper and faster compared to painted decoration, reducing the manufacturing costs and time considerably. Additionally, since decoupage prints could be produced in large numbers according to a unique design, they offered a standardised, consistent and instantly recognisable decorative image, helping Erard’s instruments to stand out among competitors.

The same pattern, combining Neoclassical elements with new techniques, can be observed on the three-dimensional decoration of Erard’s Empire harps. The design of the harp column with a capital, itself a symbolic reference to Neoclassicism [33], was already a signature feature of early Erard harps, as mentioned above, but on the Empire model its form became quite similar to the Ionian pillar found on ancient Greek monuments. Interestingly, Erard’s 1794 patent shows a harp column with a scroll; the capital is first introduced in Erard’s 1801 patent, with its outline becoming more detailed and closer to the shape found on surviving double-action harps in Erard’s 1810 patent, both of which are cited below. The ornaments on the capital typically depicted three ram’s heads linked with garlands, with swags or floral motifs above, although Egyptian elements, such as mummies, were also occasionally used, while the base of the column and the top of the pedalbox were adorned with acanthus leaves. On Erard’s Empire harps these ornaments, which on earlier harps were carved solely out of wood, consisted of a mix of gilded wood carvings and composition ornaments. Composition, essentially a thermoplastic material comprising several organic and inorganic ingredients, had the advantage of being quite soft and flexible when warm, but becoming very hard and durable when dry. Usually formed in cast moulds and produced in large numbers, composition ornaments could be glued with minor preparation directly on wooden surfaces, thus being a relatively inexpensive and reliable substitute for wood carvings that was commonly used in picture frames, furniture and architectural components during the late eighteenth and early nineteenth centuries [34].

About 1500 single-action harps of the Empire model were produced in London by Erard from c.1798 to the late 1830s, although actually only 25 of them were built between 1821 and 1837, when the last specimen is listed in the Erard ledgers [7]. Apart from Erard’s name and London address at No. 18 Great Marlborough Street, these harps bear a serial number typically engraved on the right brass plate of the mechanism, which can help to identify and date them, as will be discussed later. From c.1799 Erard’s Paris branch also started building Empire harps like those produced in London, adopting a similar system of serial numbering. This is evidenced, for example,

in the earliest surviving Empire harp bearing Erard’s name and Paris address along with a serial number, the Erard No. 7 built in Paris in 1799, now in the Musée de la musique, Paris (Inv. No. E.981.6.1), which is almost identical to Erard No. 333, made in London in 1800 (see Fig.2). Nevertheless, since Erard’s Paris branch primarily built pianos, the production rate of harps there was much lower compared to London. This is confirmed by the fact that from the late 1790s to the early 1810s only about 375 harps were built in Paris, whereas more than 1300 harps were made in London. However, it should be pointed out that although the Paris branch produced fewer harps than the London branch, focusing primarily on single-action harps up until the 1830s, it was still essential for Erard’s international market, because the Paris branch sold numerous harps abroad, particularly to European courts; this is verified in the surviving production and sales ledgers of the Paris branch, held in the Musée de la musique in Paris (Inv. Nos. E.2009.5.40-E.2009.5.177 and E.2009.5.98-E.2009.5.173).

3.3 The Double-Action Grecian Model

The next step in the evolution of the Erard harp was the introduction of the double-action harp in 1811, which ended the quest for a compact harp that could play efficiently in all keys. Previously existing chromatic harps without pedal mechanisms were cumbersome and impractical. The first attempt to devise a fully chromatic pedal harp was Cousineau’s 1782 patent for a harp equipped with 14 pedals and the *béquilles* mechanism, confirmed by one surviving specimen [35]. The second attempt was Erard’s 1801 patent (British Patent No. 2502) for a double-action harp based on the mechanism with rotating tuning pins (*chevilles tournantes*), which Cousineau had already invented in 1799 [36], an instrument which never went into production because of its unsatisfactory functionality. Erard was granted two more patents in 1802 (British Patent No. 2595) and 1808 (British Patent No. 3170), which entail his further experiments with the idea of a chromatic pedal harp, before taking his 1810 patent (British Patent No. 3332) for a double-action harp with two rows of interlinked fourchettes.

Commonly known as the “Grecian” model because of its distinctive decoration inspired by Greek antiquity, Erard’s new harp followed in many ways the design concept established with the Empire model. Although from a decorative viewpoint what is often described as Erard’s “Grecian” harp can be considered part of the broader “Empire” style, and while linking a mechanical system with a decorative style has certain limitations, for the purposes of this article the two terms have been adopted for Erard harps to denote a specific instrument model rather than an instrument with strict stylistic traits. Therefore, Empire refers to single-action Erard harps made from the 1790s to the 1810s, while

Grecian refers to double-action harps produced from 1811 to the early 1840s. This “Empire/Grecian” dichotomy has not been addressed sufficiently in the existing harp literature and should be considered a point for future clarification.

In terms of size and dimensions, as well as in terms of proportions and geometry, Grecian harps [Fig.3] are not different from Empire harps, typically having a height of 1700 mm, a maximum width of 360 mm at the bottom of the soundboard, and a maximum depth of 830 mm from capital to shoulder. The most noticeable alteration is the enlargement of the pedalbox, which on the Grecian model has a height of 130 mm, rendered necessary because of the two notches per pedal. The column is also slightly thicker than on Empire harps, with a tapering diameter of 60 to 63 mm from the bottom of the capital to the top of the base, and carved in the middle section with 20 thin flutes. Moreover, apparently due to the use of more metal parts for the pedal mechanism, there was a significant increase in the weight, from about 18 kg on Empire harps to about 20 kg on Grecian harps.

The Grecian model normally has 43 strings, a number which, contrary to earlier harps, did not fluctuate but remained constant throughout its production. Like on Empire harps, the strings on the Grecian model have sliding adjustable nuts for regulating the intonation, although these allow for fine amendments only for the first higher semitone, the second being defined by the fixed distance between the two fourchettes [32]. Interestingly, on Empire harps these nuts face towards the capital, whereas on Grecian harps they are reversed, facing towards the shoulder, possibly to prevent buzzing when a string is plucked. It is worth noting that the first 12 bass strings and the last treble string on the Grecian model have no adjustable nuts; the last string has also no fourchette. Contrary to earlier Erard harps, the pedalbox of the Grecian model has a large opening at its bottom to allow easier access to the pedals for adjustments and repairs, and probably also to provide more volume. Additionally, the single-arm pedals on Erard’s Grecian harps have springs fixed directly on them inside the pedalbox, whereas on the Empire harps the pedals are operated by springs inside the neck.

With the Grecian model, the appearance of the Erard harp became more austere and uniform. The standardised finish with a glossy black coating, gilt lines, decoupage and gilt composition ornaments, which had started with the Empire model, continued on the Grecian model. However, on Grecian harps the composition ornaments entirely replaced the painstaking and time-consuming wooden carvings on the column and pedalbox. Furthermore, although the ornaments on the pedalbox were varied, the capital was constantly adorned with three winged caryatids resembling Nike, a Greek goddess who personified victory [2]. In addition, similar to Empire harps, the decoupage

Fig.3

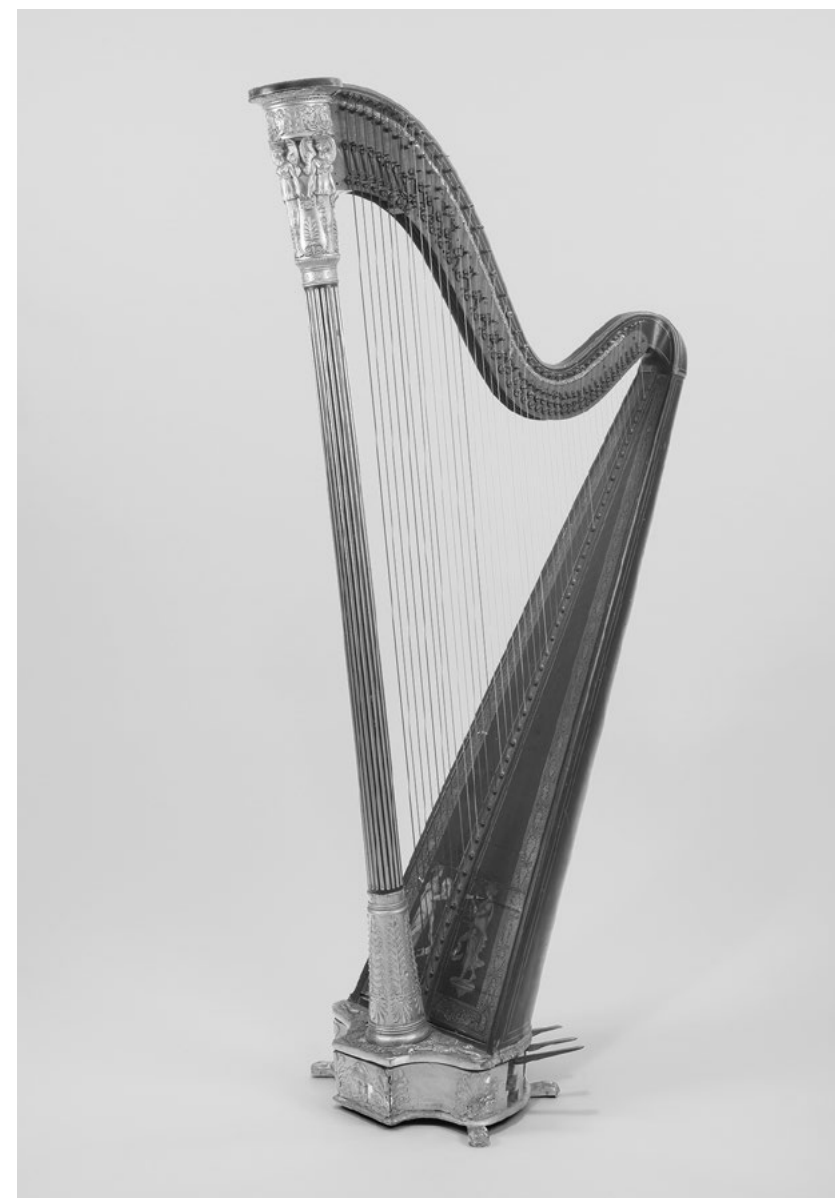

Fig.3 Typical double-action harp of the Grecian model by Erard, built in London in 1818 and bearing the serial number No. 2631, in the Deutsches Museum, Munich, Inv. No. 16147 (© Deutsches Museum, Munich, reproduced with permission).

on Grecian harps consisted of wide ornamental bordures along the soundboard edges, depicting vines, masks, vases, animals and human figures, as well as of larger prints with female musicians holding stringed, wind or percussion instruments on the soundboard and shutters. Such images, which often had an allegorical character, acting as visual representations of music and the arts, certainly augmented the appeal of Erard's harps to a clientele obsessed with the Neoclassical style. Catering to the taste of fashion-conscious customers, who purchased harps not only as musical instruments but also as elaborate pieces of furniture, Erard steadily expanded his palette by adding more colours. By the end of the 1810s, Grecian harps were offered in at least six different coloured finishes, including ultramarine blue, smalt blue, green, red, rosewood, and black [7, 37]. Two transparent finishes, in grey or yellow tone, were also available. Additional painted decoration, such as "Raphael's Arabesks", could be applied on the blue, green or red harps, which were the most expensive. Only within a few years after their debut in London, Erard's Grecian harps could be found in rich homes across the British provinces, sold as far as Edinburgh and Dublin.

Erard's Grecian model epitomised several of the latest advances in the harp trade. From a technical viewpoint the Grecian model was an effective fusion of earlier inventions which aimed to overcome the limitations of the single-action harp, starting with Cousineau's 1782 patent for a 14-pedal harp with *béquilles*, and culminating in Erard's 1810 patent for a double-action harp with fourchettes. Erard's Grecian model thus encompassed many previous innovative ideas being applied for the first time on a functional and marketable instrument, which can be considered as the original predecessor of the modern concert harp. In terms of ergonomics, it was certainly a larger and heavier instrument with more string tension than earlier harps, demanding more physical effort from the player. Moreover, the pedals on Grecian harps were positioned at a higher level, and were shorter and harder to press down and hold than on earlier harps, thus affecting the player's movements and to some extent preventing multipedalling, which was a key feature of performing on single-action harps [1]. Nevertheless, Grecian harps had a louder and more dramatic sound with a darker timbre, which better suited the Classical and Romantic repertoire of the early nineteenth century. Although they were initially met with scepticism, if not criticism, by some instrument makers and musicians, they were wholeheartedly embraced by numerous distinguished members of the polite society, not least because of a tireless promotional campaign led by Pierre Erard, who engaged renowned virtuosi, such as Nicolas-Charles Bochsa (1789-1856), to perform and compose for the double-action harp.

From an aesthetical viewpoint, the Neoclassical appearance of the Grecian model exemplified Erard's awareness of contemporary fashion.

Fig.4

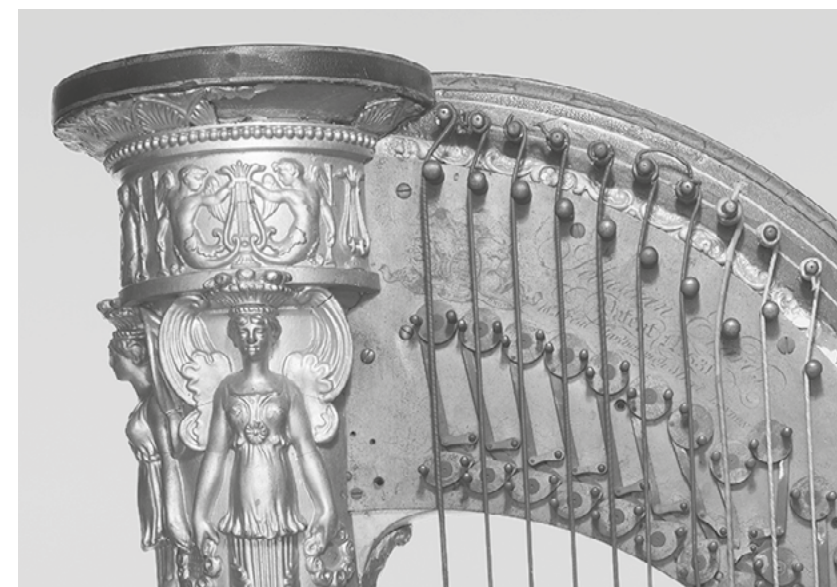

As in the case of the Empire model, Erard's decision to embellish his new harp with ancient Greek motifs is not surprising. Until the end of the eighteenth century the harp was traditionally a favourite instrument of the aristocratic and royal circles. Nevertheless, the time after the American (1776) and French (1789) Revolutions witnessed a growing hostility towards the Old Regime and its customs, and the harp needed an urgent facelift in order to gain approval from a more liberal middle-class audience [31]. Through its characteristic decoration, Erard's Grecian model was not only associated with the elegance of classical Greece, but also with the ideals of democracy, heroism and freedom, which managed to raise its marketing potential during the Napoleonic Wars and after.

Another distinctive feature of Erard's Grecian harps is their conspicuous branding on the left and right brass plates housing the fourchette mechanism, one of the most complex and eye-catching areas of the instrument. The practice of branding on the harp's mechanism was probably initiated in the 1780s by Cousineau on his harps equipped with the *béquilles* mechanism, where Cousineau's name could be seen through a glass panel on the neck. This practice became more widespread with Erard's Empire harps, and was soon imitated by other makers. On earlier French harps, the maker's signature was usually quite small and not easily detectible, in most cases inscribed or stamped on the top of the soundboard

Fig.4 Detail of the coat of arms and the inscription 'Sebastian Erard's // Patent N 2631 // 18 Great Marlborough Street LONDON' engraved on the left brass plate of Erard No. 2631 (© Deutsches Museum, Munich, reproduced with permission).

and/or on the wooden neck; some makers also used small paper labels pasted inside the soundbox or pedalbox. In contrast, the trademarking of Erard's Empire and Grecian harps is easily recognisable, as well as more consistent and permanent, therefore also more difficult to fake.

This is evident, for instance, on Erard No. 2631, a typical double-action harp of the Grecian model (see Fig.3), on which a coat of arms and the inscription "Sebastian Erard's // Patent N 2631 // 18 Great Marlborough Street LONDON" are engraved on the left brass plate [Fig.4]. This inscription informed the public not only about the manufacturer's name and address, but also about the imposing fact that he was the holder of a patent. Furthermore, the number next to the word "Patent" in Erard's inscription, commonly mistaken for a patent number, is actually the serial number of the harp. On Grecian harps this number continued the single sequence which commenced with Erard's Empire harps in the late 1790s, showing the total production of the firm rather than the production of a particular harp model. Therefore, Erard's first double-action harp, the Erard No. 1377 sold on 24 October 1811, was not given the number 1, but simply continued the numbering from the Erard No. 1376, a single-action harp [7].

Additionally, the inscription "Maker // TO THE ROYAL FAMILY // His Most Christian Majesty the King of France // And H.I.M. the EMPEROR of all the Russias" is engraved on the right brass plate of Erard No. 2631 [Fig.5]. Besides, the inscription "SERARD // PUBLISH // APRIL 19 // 1811", most likely referring to the official publication of Erard's 1810 patent, is encircled in two of the four wreaths held by the caryatids on the front of the capital, another visually attractive area of the harp. Apart from their obvious purpose as identification elements which were required, for example, in the hire, resale or repair of Erard's instruments, these inscriptions mainly acted as advertising tools as well as symbols of warranty and protection against counterfeit [38]. It is no coincidence that Erard printed similar inscriptions in his catalogues [37] and bills, as noted in Pierre's letter from 2 February 1816 [4]. Remarkably, although the trademarking of Erard harps became more perceptible, descriptive and detailed compared to earlier harps, the date of manufacture was gradually omitted; the only known Erard harps bearing a visible date of manufacture are Empire harps built in Paris c.1799-1809. Since Erard harps were produced using a quite standardised and consistent model, this would have enabled Erard to sell stock harps as if they were new.

About 3500 harps of the Grecian model were produced by Erard in London between 1811 and 1836, when they began to be slowly superseded by the "Gothic" model, labelled as such because of its decoration. This was a new, larger double-action harp with 46 strings that was introduced by Pierre Erard in 1835 (British Patent No. 6962), with the

Fig.5



Erard No. 5011, built in May 1836, being the first recorded example. Nevertheless, Grecian harps remained in production up to the early 1840s; built in September 1844, the Erard No. 5633 seems to be the last specimen of Erard's Grecian model [7].

The organological inspection of surviving Grecian harps by Erard built between the early 1810s and the late 1830s has shown that they are fairly uniform in terms of their design and construction [29], with the main distinguishing trait of these instruments being their decoration, which to a certain extent is also standardised. The standardization of these harps can be further evidenced by the extensive use of screws for joining wooden and/or metal parts together. On an Erard Grecian harp there are several hundreds of screws of different sizes, which were usually bought by the gross (twelve dozen) [7]. Utilising screws, in combination with jigs and templates, enables a more precise and stable construction, which can be carried out even by unskilled workers or apprentices. Furthermore, it minimizes both the manufacture and repair time required, for example, for the drying or removal of animal glue traditionally used in instrument making. It is worth pointing out that on Grecian harps even the most sound-sensitive component, the soundboard, is secured with screws on its outer edges, where it meets the soundbox. These screws, usually covered by long strips of

Fig.5 Detail of the inscription 'Maker // TO THE ROYAL FAMILY // His Most Christian Majesty the King of France // And H.I.M. the EMPEROR of all the Russias' engraved on the right brass plate of Erard No. 2631. The number 16147 is the museum's inventory number (© Deutsches Museum, Munich, reproduced with permission).

wood, were revealed when the Erard No. 2631 [Fig.3], an instrument retaining its original soundboard, was examined and photographed with X-rays [29]. Moreover, on Erard's Grecian harps a removable Γ -shaped wooden block (see Fig.8) is firmly screwed on the brass plate housing the mechanism, whereas on Erard's Empire harps the same part is usually attached with one or two wooden dowels on the capital.

Sébastien Erard was apparently very confident about the commercial success of his new double-action harp and had even envisioned its manufacture in a kind of large-scale system. This is evident in the construction of the double-action pedal mechanisms, which were arguably the most technically demanding components of Erard's Grecian model, requiring skilled precision work. In a letter dated 26 June 1817, Pierre wrote to his uncle that "All the parts that you had prepared for a thousand harps are used up, so that the workers in charge of mechanisms must prepare everything before assemblage, which always puts them behind" [4]. The preparation of parts for the mechanisms of a thousand harps, during a time when the firm produced less than two hundred harps annually, clearly signifies Erard's foresight and business acumen.

The Grecian model became an icon of Erard's successful entrepreneurship. As patent-protected, branded instruments endorsed by the British and European royalty and nobility, Erard's Grecian harps had increased value and prestige, which made them highly desirable in the emerging consumerist society of Regency Britain. Costing between 120 and 160 guineas—the price of a grand piano or three times the annual salary of a manual worker—these instruments were mainly aimed at wealthy, upper-class clients [5]. The great demand for these harps, which were powerful sounding devices as well as symbols of status, managed to boost both the reputation and the profits of the Erard firm, which was facing severe financial difficulties during the 1810s. It is noteworthy that even with little advertising in the press, Erard managed to develop a broad international clientele, mainly through a network of celebrity musicians and music teachers, who acted as agents, recommending his harps by giving concerts and lessons, or by word-of-mouth, usually receiving a commission [4]. With the establishment of the Grecian model, the Erard harp eventually became a global phenomenon. Apart from many European countries, ranging from Portugal to Russia, Erard's harps were also exported to North America and to the British colonies, such as India, Australia and New Zealand. Moreover, the various dedications to prominent figures found on Erard's harps, along with the many famous personalities mentioned in the Erard ledgers, serve as historical testimonies, mirroring the radical changes in international politics during the early nineteenth century, a time marked by interludes of war and peace, and the rise and fall of powerful monarchs, alliances, and empires.

4. Organisation and Workforce of the Erard London Workshop

Developed in the competitive and stimulating environment of Regency London, the Erard harp was a product of industrialisation and cross-fertilisation among various trades. As the leading manufacturer of harps in London, Erard was at the head of a comprehensive firm employing diverse crafts in a single workshop, a business model widely adopted in the production of luxury goods in nineteenth-century Britain [34, 39]. The manufacture of the Erard harp therefore resulted from the fruitful interaction between different craftsmen working under the same roof.

This is vividly reflected in the number and variety of Erard's personnel in the years before and after the arrival of the double-action harp. From a comparison of the expenses for wages, it has been stated that between the late 1800s and the mid-1810s the Erard firm "had doubled in size in terms of its inhouse workforce" [4], employing about 50 to 60 workers of various specialisations [5], presumably to cope with the more complex manufacture of the new harp. Among them were many skilled craftsmen, some of whom were not luthiers, but belonged to other trades. Erard's staff included woodworking specialists, such as joiners, turners, cabinet-makers and carvers, who were assigned with the construction of the wooden frame of the harp that consisted of the soundbox, neck and column. Interestingly, as reported in a letter from 26 October 1815, most of the cabinet-makers working at Erard were of French or German origin [4]. Moreover, professionals with mechanical or engineering expertise and the ability to carry out precision work with metal—usually trained in the making of clocks, mechanised furniture or scientific instruments—were responsible for building the functioning components of the pedal mechanism. In addition, several artisans, such as gilders, plasterers, painters, printers and engravers, were involved in the decoration of harps. The finishing, stringing, regulating and tuning of the harps would have been done by the more experienced staff, usually those with musical skills who could also play on the harp. As stated in several letters, Pierre Erard himself took lessons so that he could play the harp and also personally checked each instrument before it left the shop to ensure the high level of quality [4].

Further insight into Erard's workforce and workshop organisation can be obtained from the Paris branch, which during the late 1820s employed 18 workers involved in the manufacture of harps, corresponding to about one third of the personnel in the London branch during the 1810s. These workers were divided between three harp-making workshops, each occupied by four woodworkers, a machinist and a decorator [26]. Considering these numbers, the London branch in the 1810s may have consisted of at least nine harp-making workshops, in which 36 woodworkers, nine machinists and nine decorators undertook

all the stages of harp manufacture from beginning to the end. However, archival research has proved that between October 1811 (when the first double-action Erard harp was sold in London) and June 1812 Sébastien Erard paid the firm of George Jackson (a composition manufacturer working in close proximity to Erard) for ornamenting harps or harp-related accessories, and for cutting boxwood moulds [40]. Taking into account that the first double-action Erard harp was sold on 24 October 1811, the bill dated 3 October 1811 “To 55 harps ornamentd compleat” could refer to the first 55 double-action harps Erard ever made. Although Erard may have decorated harps in his premises, Erard’s payment to Jackson for harp ornamentation and the commission of new moulds indicates that he may have occasionally relied on subcontractors for specialist work, a topic deserving further research.

In terms of workforce number, the occasional hiring or firing of staff, some of whom would seek employment at Erard’s rivals, seems to have been a common measure in order to boost production in times of high demand or to spare expenditures when money was scarce. This is revealed in several letters, such as those on 22 September 1814 and 12 April 1815, in which Pierre Erard informed his uncle Sébastien about the current state of the London branch [4]. For example, John Rider, a cabinet maker, who in 1809 was Erard’s employee, left at some point to work for the harp-maker Edward Dodd (1791-1843), but returned to Erard in 1817, as reported in a letter from 16 December 1817. Likewise, after being fired by Erard, a worker named Frayer (or Freyer) started working for Jacob Erat (active 1798-1821), one of Erard’s main competitors, as described in a letter dated 4 July 1819. Another woodworker named Webb, who had left Erard to work for the piano-maker Robert Wornum (1780-1852), returned in 1820, as mentioned in a letter from 5 May 1820. This practice of “hire-and-fire” according to seasonal demand was not unusual among instrument-makers, as evidenced in the case of the Broadwood piano manufactory [41].

While the Erard archives are a valuable source of information on Erard’s workforce, the investigation of surviving instruments can assist in forming a more complete picture of the individuals who directly worked on Erard’s harps. For instance, between 1807 and 1809 Erard repeatedly paid Edward Lydiatt, Christoph Rogala and one Colleman for “Machines” [7], apparently referring to the pedal mechanism on Erard’s harps. In the case of Lydiatt, his signature can be found engraved on the rail of the mechanisms on Erard No. 281 (“Lydiatt // Sept 1799”, private collection), on Erard No. 470 (“Lydiatt // March, 1802”; see Fig.6, left), and on Erard No. 1224 (“LYDIATT 1809 7”, private collection). This suggests that Lydiatt was employed by Erard as a machinist at least between 1799 and 1809. In some cases, the instruments are the sole evidence of certain individuals’ participation in Erard’s workshop. For instance, the previously unknown

Fig.6



J. (Johann?) Schneegans was constructing mechanisms for single-action Erard harps as early as 1800, since the rail of the mechanism on Erard No. 333 is signed “J. Schneegans. // 30. April, 1800” (see Fig.6, right).

In contrast, although it is known that as early as 1808 Christian Haarnack (1774- ?) was head machinist at Erard [42]—with Pierre stating in a letter from 10 April 1818 that “In March, we made 19 harps, the machines are going well with Haarnack” [4]—his name has not been found on any examined Erard harps. This reflects the growing tendency towards uniformity and anonymity evident in the manufacturing sector of early industrialised Britain.

5. Serial Numbers and Manufacturing Marks on Erard Harps

As mentioned earlier, the identification and chronological classification of Erard harps has been generally based on the serial number engraved on the brass plate housing the mechanism. This number, which can be considered as the primary or official serial number of an Erard harp, is listed in the surviving Erard ledgers of the London and the Paris branches. Being often accompanied with a short description of the instrument, the date of entry and date of sale, this number can thus allow for a fairly accurate dating of surviving Erard harps.

However, the examination of numerous Erard harps made in London from the late 1790s to the early 1830s (Tables 2 and 3 in Appendix)

Fig.6 The inscriptions engraved on the mechanisms of Erard No. 470 (left) and Erard No. 333 (right) (© P. Pouloupoulos, images reproduced with the kind permission of The Fitzwilliam Museum, Cambridge, and the Royal College of Music, London, respectively).

Fig.7

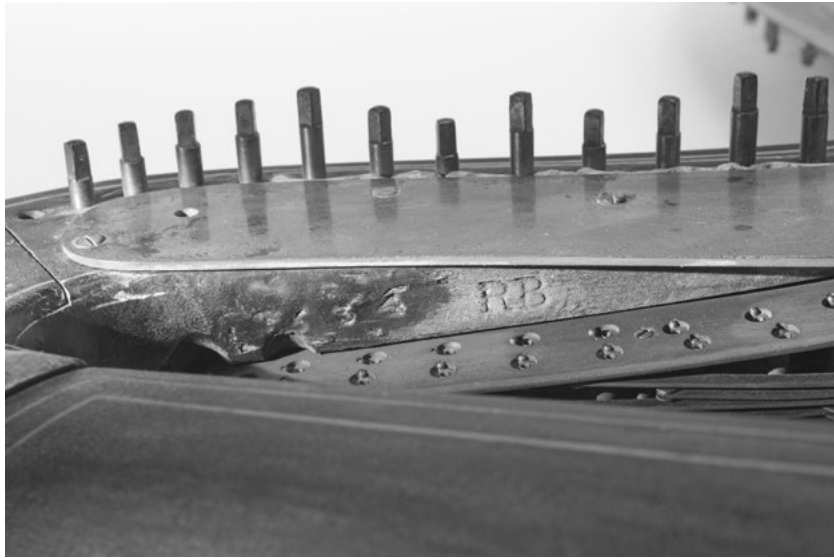

Fig.8



Fig.7 Detail of the stamp "2634 RB" on the underside of the neck near the shoulder of Erard No. 2631 (© Deutsches Museum, Munich, reproduced with permission).

Fig.8 Detail of the inked number "1945" and the stamped number "1989 // K" (right) on the removable Γ-shaped block of Erard No. 1945 (left and middle) (© P. Pouloupoulos, images reproduced with the kind permission of the Hospitalfield House, Arbroath).

has revealed that apart from this official number, one or multiple secondary serial numbers can be found on various wooden parts of an Erard harp, commonly stamped or written on hidden or inaccessible areas. Furthermore, the metal and wooden parts of Erard harps often bear additional inscriptions, such as initials, symbols, names and dates, some of which are obviously from later restoration work, but most having been added during the manufacture of the instruments. For instance, on some examined Grecian harps, the eight pedals are engraved with Roman (I, II, III, IV, etc.) or Arabic numbers (1, 2, 3, etc.), while the wooden plank above each of the pedals is pierced with a certain number of holes corresponding to the pedal's number, apparently to facilitate the correct positioning and montage of the pedals inside the pedalbox. The presence and role of such manufacturing marks and serial numbers has not been adequately addressed in the extant literature, despite their potential in providing new insights into the workshop practices of Erard.

An example can be observed upon close inspection of the Erard No. 2631 (see Fig.3,4,5). On this harp, the number 2634 is stamped on several wooden parts, such as on wooden planks inside the pedalbox or on the underside of the neck near the shoulder, where the stamp "2634 RB" can be found [Fig.7].

On Erard's Grecian harps, these hidden secondary serial numbers are typically found on a removable Γ-shaped block at the bottom junction of the capital and the neck, which allows access to the pedal mechanism [Fig.8]. However, as shown above, they may also be stamped under the neck near the shoulder or inside the pedalbox, or even on parts of the pedal mechanism. It is noteworthy that there is no specific correlation between the official and the secondary serial numbers, since on some harps the secondary number stamped on the wooden structure is higher and on others lower than the official number engraved on the brass plate; it is the exception rather than the rule that the same number is present on both metal and wooden parts.

According to what has been proposed about the application of serial numbering on musical instruments [43], the official and secondary numbers found on Erard harps may have been used for the following reasons: a) to monitor instruments in stock and organise records of sales; b) to identify parts of the same instruments while they were being worked on in different areas within a workshop; c) to identify instruments for after-sales service and repairs, and to facilitate the supply of replacement parts; d) to enable quality control, since once a defect is found in the production of a particular batch of product, the serial number will help

identify further units which may also be affected; e) to show the size of a firm's production by continuing serial numbers to very high numbers; and f) to prevent counterfeiting and help trace stolen items.

Regarding the secondary numbers and other manufacturing marks, such as initials or inscriptions, although Erard archival sources do not explicitly mention them, neither do they directly confirm their exact function or role in Erard's workshop operation, they may refer to certain employees or departments in Erard's London workshop. Such marks were most likely used to control the various stages of harp manufacture within a large and busy workshop arranged for serial production of standardised items, such as that of Erard.

Another plausible explanation for the existence of these marks can be drawn from related trades which employed a similar manufacturing process. For instance, a comparable marking system can be observed in the furniture produced by Gillow, an important manufacturer in Lancaster during the early nineteenth century. While the firm's name would be prominently displayed on the finished product, various marks such as inscriptions and stamps, could also be found on hidden parts [44]. These marks were essential for the internal communication and quality control within large manufactories employing numerous workers. It has been argued, for instance, that "signatures and dates would have enabled a journeyman to identify his work for payment purposes", while at the same time allowing "his employer to monitor and check the quality of his employee's workmanship" [44].

The concept of serial numbering and marking can be further examined within the broader framework of the musical instrument-making business, which also became progressively standardised over the course of the nineteenth century. One example that helps to place the standardisation and serial production of the Erard harp in its contemporary context is the manufacture of harp lutes. These were hybrid plucked instruments combining features of the harp, lute, cittern and guitar, which were introduced by Edward Light (c.1747/8-c.1832) in London during the early nineteenth century. Light kept modifying and improving the design of his instruments, which he advertised as portable substitutes for the harp, and by the time he started applying serial numbers on his updated harp lute around 1813, the instrument "had reached the stage of virtual completion and standardisation" [45]. This is confirmed by the fact that numerous surviving harp lutes bearing serial numbers, manufactured from 1813 onwards, are more standardised compared to earlier specimens, having a consistent design and identical dimensions. Likewise, early Erard harps built in Paris c.1790, which were experimental designs produced on a small scale, did not have serial numbers. However, once Erard started building more standardized instruments in London based on his 1794 patent with the fourchette mechanism, he began using serial numbers.

The evolution of the Erard harp shared many similarities with the changes observed in the piano industry during the early nineteenth century, when standardisation replaced diversity and individuality [46]. In his systematic use of serial numbers, Erard can be compared to his contemporary, Clementi & Co., one of the leading piano manufacturers in Regency London. During the early nineteenth century, the firm established by Muzio Clementi (1752 -1832) became the largest exporter of musical instruments from England, taking advantage of Clementi's international contacts and renowned status as a music composer and publisher. Through his multilingual skills, his business acumen and his extensive travelling across Europe, Clementi maintained important contacts in many countries, which helped him to continue promoting and distributing his instruments even during the trade embargos imposed due to the Napoleonic Wars. Despite a disastrous fire in 1807 and the fierce competition within the London piano trade, Clementi was the second-largest piano manufacturer after the Broadwood firm, producing 1100-1200 pianos around 1810-1811 at the peak of his output [47].

From various perspectives, Clementi's profile as a piano manufacturer is analogous to that of Erard as harp manufacturer, especially given the fact that Erard also built pianos. Furthermore, Clementi is a very close contemporary of Sébastien Erard, considering that he was born in 1752, the same year Erard was born, and died in 1832, just one year after Erard's death. It is likely that Erard was personally acquainted with Clementi, since he sold harps to him [7]; Clementi is also mentioned in the correspondence between Pierre and Sébastien Erard [4]. Thus, although his production was focused on a different type of instrument, Clementi can be used as an equivalent case for understanding and decoding the production strategies of Erard harps in terms of serial numbering and marking.

Clementi numbered his pianos using "a rather sophisticated system, apparently more elaborated than for other instrument manufacturers" [47], most of whom used a single number series for all the instruments they produced, regardless of the different instrument types or models. On a Clementi piano a stamped number ("A number") usually refers to the production of a particular instrument model (square piano, grand piano, etc.), whereas an inked number ("B number") refers to the total production of the firm since 1798. After the piano case, which was usually marked with a different number ("C number"), had been completed in the cabinet-making department of the firm, the various internal parts of a piano, such as the action, wrest plank, tuning pins, etc., would be installed and the A number would be stamped on the instrument. The B number would be added at the very end, probably when the instrument was finished and was ready to leave the workshop for sale.

Based on the analysis of the serial numbers found on Erard's harps, a similar production pattern can be proposed for the Erard London workshop, even though, unlike Clementi, Erard used a single sequence for his harps. The various wooden parts of the harp, such as the soundboard, soundbox, neck, column, and pedalbox, would be made in batches and stamped with what was referred to earlier as the secondary number. These parts would be then set aside and prepared for decoration with coloured coatings, decoupage, composition ornaments and gilding. Depending on the type and complexity of the decoration, some harp parts would be completed sooner than others, and would thus be ready for assembly and finishing. The last stage would be the mounting of the pedal mechanism, on which the official serial number was already engraved. As mentioned earlier, both the official and the hidden secondary numbers are typically found on the removable Γ -shaped block, a piece most likely added at the very end. This and the fact that the official serial number is written in ink rather than stamped (providing flexibility for a last-minute addition) seem to confirm the assumption that the production of wooden and metal parts was carried out in batches in separate departments of Erard's workshop and not numbered simultaneously. Production in batches is also evidenced by the fact that there is usually only a small discrepancy between the two numbers, with only the last one or two digits on the wooden parts being higher or lower than those on the brass plate.

The survey of harp entry dates in the Erard London ledgers for the year 1818, in which Erard No. 2631 [Fig.3] was produced, has revealed that during this year Erard produced three to four harps per week, which were usually registered on Mondays, with the exception of September and October, in which they were registered on Saturdays. Interestingly, the majority of these harps were sold within few days or weeks after completion, a factor that indicates both their great popularity and the speed at which they had to be made, though in many cases Erard harps were hired before sale. This rather curious practice of "pre-sale hire" of instruments must have not been unusual in Regency London, as it was also employed by the piano manufacturer Broadwood [41].

6. Conclusions

The Erard harp is only one example of the transformation of the musical instrument trade during the early industrial era. During this significant period in European history, the Erard firm was at the forefront of innovation from a technical, aesthetic and commercial perspective. Following an experimental phase which had started in Paris with the single-action harp, Erard improved on and rationalized the design of the pedal harp, culminating in the double-action harp in London. Erard also conceived effective workshop strategies and standardized manufacturing

procedures which resulted in higher consistency and efficiency of production, helping him cope with the rapidly growing demand for harps in Britain and abroad. The evidence presented in this article shows that Erard was aware of the current developments in the musical instrument business as well as in related trades, ranging from the decorative arts to furniture-making and printing. Erard harps illustrate the transfer of technologies that characterised the manufacture of luxury products during this time. This is exemplified, for instance, by the use of decoupage and composition ornaments on Erard harps as cheap, consistent and flexible alternatives to painted decoration and wooden carvings. Another example concerns the use of interchangeable and adjustable components fixed with screws, enabling later repairs and modifications. Additionally, the application of serial numbers and other manufacturing marks, which became integral to the building of Erard harps, provide evidence of industrial practices involving division of labour and "assembly-line" systems at Erard's London workshop. Furthermore, the distinctive trademarking of Erard harps served as means of advertising and marketing. Finally, as evidenced in this article, previously overlooked archival material and surviving instruments proved to be invaluable sources of information, providing novel insights into Erard's London workshop practices—and instrument-making in the nineteenth century in general—demonstrating that these sources deserve more attention for further research.

Appendix: Lists of Examined Erard Harps

Table 1

No.	Collection	Location	Inv. No	Date
-	Musée de la musique	Paris, France	E.2016.1.1	c.1790
-	Muziekinstrumentenmuseum	Brussels, Belgium	JT0005	c.1790
-	Musée de la musique	Paris, France	E.2100	c.1790

Table 2

No.	Collection	Location	Inv. No	Date
183	Museu de la Música	Barcelona, Spain	MDMB 515	c.1798
333	Royal College of Music Museum	London, UK	RCM 298	1800
470	Fitzwilliam Museum	Cambridge, UK	M.8-1941	1802

Table 3

No.	Collection	Location	Inv. No	Date
1753	Museu de la Música de Barcelona	Barcelona, Spain	MDMB 513	1814
1945	Hospitalfield House	Arbroath, UK	NA	1814
2419	Abbotsford House, Home of Sir Walter Scott	Abbotsford, UK	T. AT. 3665	1817
2631	Deutsches Museum	Munich, Germany	16147	1818
2672	Muziekinstrumentenmuseum	Brussels, Belgium	3952	1819
2914	Abbotsford House, Home of Sir Walter Scott	Abbotsford, UK	T. AT. 1784	1820
3006	Musée de la musique	Paris, France	E.991.14.1	1820
3070	Musée de la musique	Paris, France	E.0997	1821
3830	Musée de la musique	Paris, France	E.2003.5.8	1826
3908	Fitzwilliam Museum	Cambridge, UK	M.9-1941	1826
4153	Private collection	Fürth, Germany	NA	1828
4534	Nancy Thym, Museum und Archiv für Harfengeschichte	Freising, Germany	NA	1832
4568	Musical Instruments Museum Edinburgh	Edinburgh, UK	176	1832

Table 1 Early single-action harps produced by Erard in Paris

Table 2 Single-action Empire harps produced by Erard in London

Table 3 Double-action Grecian harps produced by Erard in London

ACKNOWLEDGEMENTS: The authors would like to thank the following persons for assisting in the examination of Erard instruments and archives mentioned in this article: Silke Berdux, Marisa Pamplona and Alexander Steinbeißer (Deutsches Museum, Munich); Gabriele Rossi Rognoni, Michael Mullen and Susana Caldeira (Royal College of Music Museum, London); Thierry Maniguet (Musée de la musique, Paris); Marisa Ruiz Magaldi, Manel Barcons and Esther Fernández (Museu de la Música, Barcelona); Pascale Vandervellen, Anne-Emmanuelle Ceulemans and Joris De Valck (Muziekinstrumentenmuseum, Brussels); Nik Zolman (Fitzwilliam Museum, Cambridge); Jenny Nex and Jonathan Santa Maria Bouquet (Musical Instrument Museums, Edinburgh); Kirsty Archer-Thompson (Abbotsford House, Home of Sir Walter Scott, Abbotsford); Lucy Byatt, Laura Simpson and Juliane Foronda (Hospitalfield House, Arbroath); Kathrin Menzel and Heidrun Rosenzweig (Schola Cantorum Basiliensis, Basel); and Nancy Thym (Museum und Archiv für Harfengeschichte, Freising). The authors are further indebted to the harp scholars Robert Adelson (Conservatoire à Rayonnement Régional de Nice) and Maria Christina Cleary (Haute école de musique de Genève), as well as to the harp-makers and restorers Mike Parfett (London) and Beat Wolf (Schaffhausen), for sharing valuable information on harps by Erard and other makers. Finally, the authors are grateful to the steering committee of the WoodMusICK COST Action FP1302, especially to the editors and reviewers of this publication for their useful remarks, as well as to the Volkswagen Foundation for the financial support of this research.

References

- [1] M. C. Cleary, "The 'harpe organisée', 1720–1840: Rediscovering the lost pedal techniques on harps with a single-action pedal mechanism," Ph.D. dissertation, Leiden Univ., Leiden, 2016.
- [2] R. Rensch, *Harps & Harpists*. Bloomington, IN: Indiana Univ. Press, 1989.
- [3] B. Woodcroft, *Patents for Inventions, Abridgements of Specifications Relating to Music and Musical Instruments, AD. 1694–1866* (Facsimile edition of the original 1871 ed.). London: Bingham, 1984.
- [4] R. Adelson *et al.*, *History of the Erard Piano and Harp in Letters and Documents, 1785–1959*. Cambridge: Cambridge Univ. Press, 2015.
- [5] J. Nex, "The business of musical-instrument making in early industrial London," Ph.D. dissertation, Goldsmiths College, London, 2013.
- [6] R. M. Hallo, "Erard, Bochsa and their Impact on harp music-making in Australia (1830–1866): An early history from documents," Ph.D. dissertation, Univ. of Adelaide, Adelaide, 2014.
- [7] Erard London Harp Ledgers. Royal College of Music, London, RCM 497.
- [8] E. McClung Fleming, "Artifact study. A proposed model," in T. J. Schlereth, *Material Culture Studies in America*. Walnut Creek, CA: Alta Mira Press, 1982.
- [9] J. D. Prown, "Mind in matter. An introduction to material culture theory and method," *Winterthur Portfolio*, vol. 17, pp. 1–19, 1982.
- [10] J. D. Prown, "The truth of material culture. History or fiction?" in W. D. Kingery and S. D. Lubar, Eds., *History from Things. Essays on Material Culture*. Washington, D.C.: Smithsonian Institution Press, 1993, pp. 1–19.
- [11] S. M. Pearce, "Thinking about things," in S. M. Pearce, Ed., *Interpreting Objects and Collections*. London: Routledge, 1994, pp. 125–132.
- [12] P. Pouloupoulos *et al.*, "The industrialisation of the early pedal harp: Detecting evidence on wood and metal," in M. A. Pérez and S. Le Conte, Eds., *Proc. of the 3rd Annual Conf. of COST Action FP1302 WoodMusICK*, Barcelona, 2016, pp. 185–190.
- [13] B. Wackernagel, *Europäische Zupf- und Streichinstrumente, Hackbretter und Aolsharfen*. Frankfurt am Main: E. Bochinsky & Deutsches Museum, 1997.
- [14] D. Droysen-Reber, *Harfen des Berliner Musikinstrumenten-Museums*. Berlin: Staatliches Institut für Musikforschung Preußischer Kulturbesitz, 1999.
- [15] R. Rensch, *Three Centuries of Harpmaking*. (n.p.): Western Central, 2002.
- [16] M. Baldwin, "The Erard harp manufactory: Painted and gilded decoration 1821–1826," *The Galpin Society Journal*, vol. 66, pp. 149–164, 2013.
- [17] S. Walter, "Die Einfachpedalharfe 512 der Brüder Erard aus dem Couven-Museum Aachen: Untersuchungen zu Bestand, Zustand, historischer Kontextualisierung, sowie Durchführung der Konservierung, Restaurierung und Neubesaitung," Academic thesis, Fachhochschule Erfurt, Erfurt, 2011.
- [18] F. Bühl, "Untersuchung einer Erard-Doppelpedalharfe von 1820–1825," BA Dissertation, Technische Universität München, Munich, 2014.
- [19] L. Richter, "Fassungsuntersuchung der Doppelpedalharfe No. 2631 von Sébastien Erard aus dem Deutschen Museum München: Ein Beitrag zur Harfenforschung," BA Dissertation, Technische Universität München, Munich, 2016.
- [20] L. Richter, "Ergänzende Untersuchung an der Doppelpedalharfe No. 2631 von Sébastien Erard aus dem Deutschen Museum München," Project work, Technische Universität München, Munich, 2017.
- [21] L. Libin, *A Checklist of European Harps*. New York: Metropolitan Museum of Art, 1979.
- [22] M. Müller, *The Power of the Harp*. Copenhagen: Musikhistorisk Museum og Carll Claudius' Samling, 1993.
- [23] Van der Meer J. H., *In Search of Lost Sounds. Art and Music in the Instruments Collection of Fernanda Giuliani*. Milan: Villa Medici Giuliani, 2006.
- [24] R. Adelson *et al.*, *Erard and the Invention of the Modern Harp, 1811–2011*. Nice: Musée du Palais Lascaris, 2011.
- [25] R. Frick, Ed., "Sébastien Erard. Ein europäischer Pionier des Instrumentenbaus," in *Proc. Int. Erard Symposium*, Michaelstein, November 13–14, 1994.
- [26] A. Griffiths *et al.*, Erard, in L. Libin, Ed., *The Grove Dictionary of Musical Instruments*, 2nd ed. New York: Oxford Univ. Press, 2014, Vol. 2, pp. 234–237.
- [27] MIMO. Musical Instrument Museums Online. <http://www.mimo-international.com/MIMO>.
- [28] B. Wolf, *Harp Archives*. Schaffhausen: (n.p.), 2016, including unpublished restoration reports and other information concerning historical harps.
- [29] P. Pouloupoulos *et al.*, "Conservation issues on historical pedal harps: Preserving tangible and intangible properties," in P. Vandervellen, Ed., *Proc. of 4th Annual Conference of the COST Action FP1302 WoodMusICK*, Brussels, 2017, pp. 69–72.
- [30] J.-L. Le Carrou, S. Le Conte and J. Dugot, "18th and 19th French harp classification using vibration analysis," *Journal of Cultural Heritage*, vol. 27, pp. 112–119, 2017.
- [31] M. Parker, *Child of Pure Harmony: A Source Book for the Single-Action Harp*. London: Parker, 2005.
- [32] P. Barbieri, "Harps versus pianos: Parisian querelles on tuning 1770–1830," *Galpin Society Journal*, vol. 77, pp. 45–63, 2017.
- [33] D. Irwin, *Neoclassicism*. London: Phaidon, 2000.
- [34] P. Kirkham, "The London furniture trade, 1700–1870," *Furniture History*, vol. 24, pp. i–219, 1988.
- [35] R. Adelson, "Rediscovering Cousineau's fourteen-pedal harp," *Galpin Society Journal*, vol. 63, pp. 159–178, 2010.
- [36] D. Droysen-Reber, "Die Cousineau-Harfe mit den 'chevilles tournantes,'" *Musica instrumentalis* vol. 3, pp. 129–137, 2001.
- [37] *Erard Catalogue*, c.1820. Univ. of Glasgow, Special Collection, A.x.24.
- [38] P. Pouloupoulos, *New Voices in Old Bodies. A Study of 'Recycled' Musical Instruments with a Focus on the Hahn Collection in the Deutsches Museum*. Munich: Deutsches Museum, 2016.
- [39] M. Snodin and J. Styles, *Design & the Decorative Arts. Georgian Britain 1714–1837*. London: V&A Publications, 2004.

- [40] George Jackson and Sons Ledger. *V&A Archive of Art and Design*, London, AD/2012/1/2/1.
- [41] A. Laurence, "The evolution of the Broadwood grand piano 1785–1998," Ph.D. dissertation, York: Univ. of York, 1998.
- [42] M. Bonnington, "The oldest harp maker in the world," *Galpin Society Journal*, vol. 54, pp. 45–55, 2001.
- [43] A. Myers, "Use of serial numbers in dating musical instruments," from *Journée d'étude – Dater l'instrument de musique*, Cité de la musique, 2009.
- [44] S. Stuart, "A survey of marks, labels, and stamps used on Gillow and Waring & Gillow Furniture 1770–1960," *Regional Furniture*, vol. 12, pp. 58–93, 1998.

- [45] H. Sugimoto, "Harp lutes in Britain, 1800–1830. Study of the inventor Edward Light and his instruments," Ph.D. dissertation. Univ. of Edinburgh, 2015.
- [46] M. Cole, *The Pianoforte in the Classical Era*. Oxford: Clarendon Press, 1998.
- [47] L. Sahlqvist, "Clementi & Co. 1798–1830: Piano manufacture in London," in "The pianos of Muzio Clementi," *Friends of Square Pianos*. Available: <http://www.friendsofsquarepianos.co.uk/the-clementi-page/>. Accessed Mar. 20, 2018.

The Music of the Mulberry: Wood Science, Know-How and Symbolism in Instrument-Making in Khorāssān (Iran) and Central Asia

FARROKH VAHABZADEH

Associate Researcher, Museum National d'Histoire Naturelle,
Musée de l'Homme, Paris, France

Abstract

In manufacturing dotārs, the long-necked lute of Khorāssān and Central Asia, makers use different materials, usually of plant or animal origin. These materials may vary from one region to another, but one material, mulberry wood, is consistently used across all different traditions and regions. The link between the musical sphere and the surrounding environment concerns various musical fields: the myths around the creation and fabrication of the dotār, the musical structure, and the symbolism related to the music and the instrument itself. Through in-depth ethnomusicological research and multiple field interviews with Iranian and Central Asian instrument-makers, this paper attempts to shed light on the beliefs, local know-how and wood science pertaining to dotār production.

Introduction

The research I conducted [1, 2] between 2005 and 2010 on the music of the *dotār*, the long-necked lute of Khorāssān and Central Asia, began with a comparative study of how this instrument is manufactured in different regions. To make a *dotār*, luthiers use different materials, usually of plant or animal origin. These materials may vary from one region to another, but one material, mulberry wood, is consistently used across all different traditions and regions. Over the course of this research, it appeared that the *conditio sine qua non* for considering an instrument a *dotār* was the fact that it was made of mulberry wood. In fact, the link between the musical sphere and the environment is not limited to the mulberry alone. These relations concern various musical fields: the myths around the creation and fabrication of the *dotār*, the musical structure, and the symbolism related to the instrument itself. The following pages attempt to shed light on various aspects concerning wood science and local know-how in *dotār* production.

The *Dotār*

The *dotār* (Persian: دو تار, Tajik: дутор, Uzbek: dutor, Uyghur: دۇتتار, Karakalpak: duwtar) is a long-necked lute with two strings that are usually made of silk or steel. Its name comes from Persian: *do* denotes the number two and *tār* means string. In the cultures we study here, *tār* also means “lute”. Thus, the *dotār* is a lute with two strings. We find its trace in ancient music treatises under the generic name *tanbur*. Al-Fārābī (tenth century) in his *Kitab al-Musiqa al-Kabir* [3], a treatise on the music and the musical instruments of his time, described two different *tanbur* from Baghdad and Khorāssān¹. But the name “*dotār*” appears for the first time in a treatise by Zeyn Al-Abedin Mahmud Hussaynī (fifteenth century) [4].

Today, the *dotār* is played over a wide geographic area, from the province of Khorāssān in Iran (divided into three provinces in 2004) to the Xinjiang region of China, and in various countries of Central Asia such as Uzbekistan, Tajikistan, Turkmenistan and Karakalpakstan.

The instrument, in all its variant forms, is made up of eight parts: the body, the soundboard, the neck, the pegs, the bridge, the nut, the tailpiece and the strings. Certain organological aspects, manufacturing strategies and the vernacular name of the instrument may change from one region to the next. However, the basic principles remain the same. Traditionally, the different parts of the instrument were made from plant materials (mostly wood) or animal materials (horn, bone, gut and silk).

1 Corresponding today to parts of Iran and Central Asia.

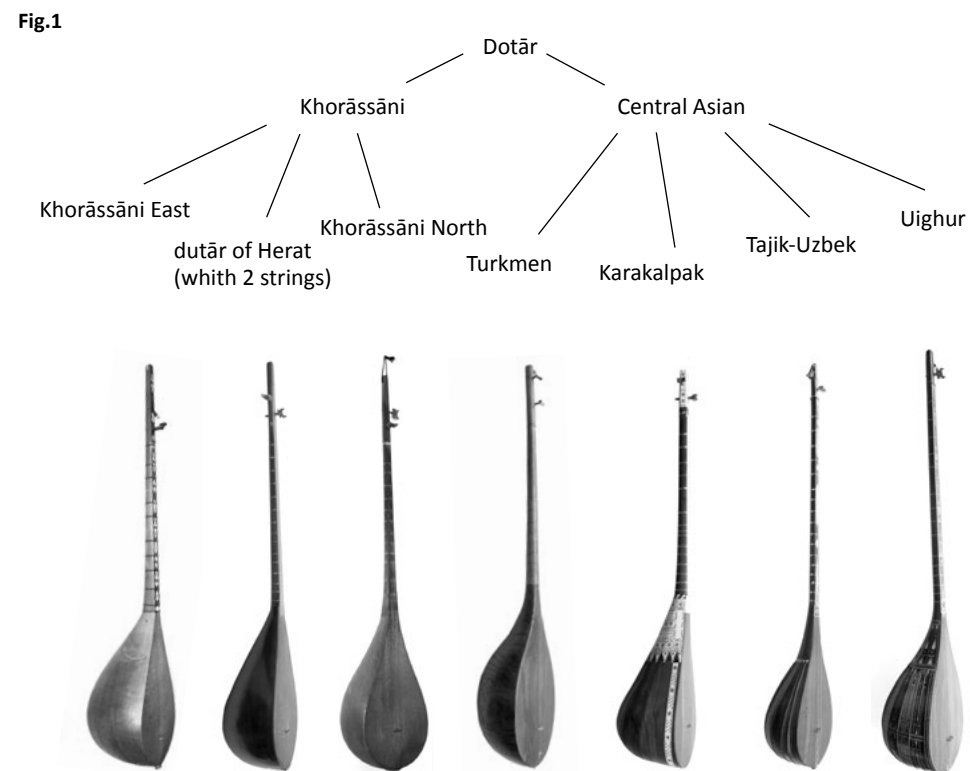

Fig.1 The family of dotars in Iran and in Central Asia

Nowadays, metals and synthetic materials are also used in some regions. However, materials of plant and animal origin remain dominant.

The soundboard and body of the instrument are made from mulberry wood. They can be monoxyclic or made from different ribs glued together. The neck is made of hardwood, mainly from the apricot tree. The two strings of the instrument can be silk (the *dotār* in the Tajik-Uzbek tradition and the Uyghur *dotār*) or steel (Turkmen, east and north Khorāssāni *dotār*s). Nowadays, synthetic materials such as nylon are also used instead of silk. The strings are tuned in fifth, fourth, or sometimes in unison or octave. Other tunings are not common. The instrument has eight to fourteen frets, depending on the musical tradition.

The *dotār* is generally used in solo performance. It may accompany a song, including popular songs (Persian, different Turkic languages or Kormanji Kurdish), epic poems and festive music, as well as the canonical repertoires such as *Shash-maqam* in Uzbekistan and Tajikistan. There is also a repertoire of mostly instrumental pieces in the re-

gion of Eastern Khorāssān. The dotār is the instrument of the *bakhshi*, musician-singer bards of Northern Khorāssān in Iran and Central Asia.

The Mulberry Tree

The story of the mulberry tree in Central Asia is closely related to silk and its production. According to Mubaliev, for centuries, silk was produced in China and the emperors enforced a ban on its export and made sure that knowledge of silk production could not spread outside the country [5]. The legend tells how the secret of silk arrived in Central Asia, along with the mulberry tree.

[...] One day, the King of Khotan, a Buddhist kingdom situated along the Silk Road between China and Pamirs, asked for the hand of a Chinese princess in marriage. As a dowry, the story goes, he sought no gold, silver or precious stones, but only mulberry seeds, silkworms and craftsmen skilled in the production of silk. Knowing that it was prohibited to take these across the border, but that the border guards would not dare touch her royal person, the princess concealed the silkworm cocoons in her headdress and the mulberry seeds in her attendants' medicine chest. Thus they arrived at the court of Khotan. When asked where the craftsmen were, the princess pointed at her attendants. In China, she explained, the making of silk was a skill only women possessed [5].

In Iran, the mulberry tree (*derakht-e tut*, in Persian) is an important, even sacred tree for the musicians and luthiers of Khorāssān. According to them, "It is a tree that leaves no unused parts: we eat its delicious fruit, the leaves are fed to silkworms (that, in turn, produce the silk used for the strings), and once the tree is dead, we create dotārs, which allows the tree to continue its life through the instrument". There are many myths and stories of saints related to the mulberry tree and dotār manufacturing. These stories contain particular details and know-how about making the instrument and the importance of music in these cultures.

According to one legend, the prophet Zakariyā (Zachariah) was being pursued by his enemies. He arrived in the middle of a desert where there was no refuge to be found. The prophet stopped in front of a mulberry tree and asked God to hide him and protect him from his enemies. God agreed to help him if he kept silent no matter what. Zakariyā agreed to the terms and God ordered the mulberry tree to open and hide the prophet in its trunk. The mulberry tree did as commanded by God. The enemies arrived near the tree, looking for the missing Zakariyā. They concluded that he must be hiding in the tree and begin to cut the trunk (and the prophet) into small pieces. Because of his pact with God,

the prophet remained silent and did not express his pain². The musicians of Khorāssān believe that Zakariyā's repressed cries of pain come out (as music) from the dotār made from mulberry wood.

According to local tradition, one may not cut a mulberry before the tree's natural death. One musician explained how he endured a curse when he tried to dry out a mulberry tree with cement because it was planted in the middle of his garden and he wanted to dispose of it. Having long worked with musicians and luthiers in Khorāssān, I found that most of them have excellent knowledge of wood science. Beyond the preference of each luthier, it seems that the best mulberry wood for building the body of a dotār is from a tree that has not been irrigated much in its life. Such trees are usually found far from rivers. The luthiers refer to this wood as *khat-riz* (thin-lines), which means that the concentric circles of the wood are tight (because the tree received little water). Tokhmkar, a luthier in Torbat-e Jām in the East of Khorāssān, chooses mulberry trees that have rough, dark brown bark with shallow crevices to make his dotārs.

Haddad Kargar Gelyani, a luthier in Northern Khorāssān, is very knowledgeable about different types of mulberry trees. He explains that there are fruitless mulberry trees (*tut-e bi-Mive*), male mulberries (*nar-tut*), female mulberries, black mulberries (*tut-e siah*) and mulberries with large flowers (*gol-dorosht*). He considers the latter to be the best *khat-riz* wood for dotārs. According to him, the male mulberry (*nar-tut*) has wider lines (*khat-dorosht*): a body made from this wood does not offer good sound quality.

Fig.2



² An illustration of this scene can be found on the website of the Worcester Art Museum: "The Prophet Zakariya in the Tree, from a Falnama, about 1550, Persian (Tabriz or Qasvin), Safavid dynasty, Opaque watercolor on paper, Calligraphy on reverse in nastaliq script" [<http://www.worcesterart.org/collection/Islamic/1935.16.html>] However, from the image alone, it cannot be concluded that the tree is a mulberry.

Fig.2 Examples of bodies made of *khat-riz* (left) and *khat-dorosht* (right) mulberry wood.

The soundboard is also made of mulberry wood. During this study, on several rare occasions, I came across dotār bodies made from some other wood species than mulberry; however, in the entire region, I have never seen a dotār soundboard not made of mulberry wood. The soundboard made from mulberry wood seems to be the distinguishing feature for the dotār, compared to other long-necked lutes in the region. There are a wide range of sometimes contradictory opinions on the best choice and type of wood to use. According to some luthiers, sound quality is better when the wood from the same mulberry tree is used for both the soundboard and the body. Other luthiers believe that the instrument sounds better when different kinds of mulberry woods are used for the body and the soundboard. Ranjbar, a bard *bakhshi* of Northern Khorāssān, quotes his master: “The soundboard and the body are like two lovers: if a *khat-riz* wood is used for the body, it is better to make the soundboard with *khat-dorosht* wood, and vice versa. If a male wood is used for one, the other must be from a female tree.”

Luthiers affirm that the choice of wood for the neck has no direct influence on the sound quality of the instrument. In this instance, it is a functional criterion that matters, i.e. the hardness of the wood. The preference is for fairly firm and hard woods, especially from the apricot tree in the North and sometimes jujube trees in Eastern Khorāssān. According to a luthier named Haddad, the average lifetime for the neck of a dotār played and owned by a virtuoso is about ten years. After this period, due to the pressure of the fingers, traces and dips appear on the neck, especially in the spaces between frets. These traces influence the accuracy of the pitch, and consequently, the neck must be changed. According to Haddad, there are two types of apricot trees: those bearing fruits with a sweet kernel, and those bearing fruits with a bitter kernel. Although not as hard, the wood of the former is more appreciated since it has no knots and turns red quickly, creating colour harmony between the neck and the body. The reddish colour of the neck seems to be an important and desired criterion for musicians; luthiers sometimes use alkaline products to accelerate the process of the wood turning red.

Myths

There are numerous myths around the dotār and the manufacturing of the instrument in the regions of Eastern and Northern Khorāssān. In most of these myths, the human, the animal, the plant and the symbolic universe come together in the creation of the instrument.

The creation of the dotār is often attributed to Qanbar (pronounced Qambar), said to be the squire of Hazrat-e Ali, the first Imam of the Shiites. Legend has it that Imam Ali was going to war and asked Qanbar to stay and wait for him. While waiting for his master, Qanbar

got bored. He took a piece of wood and a few hairs from the tail of his master’s horse and began making an instrument. The result did not have a good sound and did not satisfy him. An old man with a white beard appeared to him, approached Qanbar and asked what he was doing. Qanbar pointed to his rudimentary instrument and explained that it did not have a good sound. The old man told Qanbar that he was willing to help if the squire agreed to share the invention of the instrument with him. Qanbar agreed. The old man added a small piece of wood at the end of the neck (where the nut must be located today) which allowed the strings to vibrate. The result was miraculous. Qanbar played incessantly until Imam Ali returned from war. When Ali asked him what he was doing, Qanbar told his master the story of the instrument and of the old “wiseman” who had helped him. Imam Ali said it was the devil (*Sheytān*) who had appeared, disguised as an old man, and that he had contributed to creating this instrument. This explains why the nut is called the “little Satan” (شیطانک *Sheytānak*) in all regions of Northern and Eastern Khorāssān, and “the little donkey of Satan” or “the bridge of Satan” (шайтон-харақ *Shayton Kharak*) among Tajiks and Uzbeks.

A variant of this myth was also collected by Beliaev and Uspenskii [6], as cited by Slobin [7].

A close friend of Muhammad’s, Hazrat Ali, had a very beautiful horse named Dyul-dyul, for whom he took a groom, Baba-Kambar. This groom made a dutar and played on it so well, that Dyul-dyul began to grow thin. Seeing that the horse was suffering, Hazrat Ali began to worry about it, and suddenly coming into the stable, discovered Kambar playing on the dutar. Kambar was so frightened by his master that he wanted to smash the dutar on the barrel. But Hazrat Ali stopped him and asked him to tell what sort of thing this was and how he made it. Baba Kambar said that when he made the dutar, it didn’t produce any sounds until the evil helped him, after which it began to play [7].

For Slobin, the fact that the instrument was inspired by the devil illustrates the negative attitude towards musical instruments and music itself in the region; he believes this attitude continues to have considerable weight among all people in these regions [7]. We suggest that the coexistence of these myths and legends with the belief that the music produced by the instrument is the cry of pain of Zakariyā (a prophet, and thus a highly respected figure) shows that the attitude toward music in these regions is more complex and cannot be cast as simply negative.

The making of the dotār in Khorāssān is sometimes attributed to Luqman the sage (*Loqman-e hakim*), a famous physician and philosopher during antiquity. One anecdote highlights another important aspect of making the instrument: the story goes that Luqman made his dotār without digging out the inside of the body. His instrument was not

making a good sound, and he had no idea how to solve the problem. One day, by chance, Luqman noticed that a boy who had been singing beautifully that morning at the market was singing very badly after the midday meal. He asked the little boy what had happened to him and why his voice had changed. The boy replied that before noon his stomach was empty, which allowed him to sing well, whereas after the midday meal he had a full stomach and was no longer able to produce beautiful song. After this conversation, Luqman realized that a “full body” did not allow for good sound. He began to hollow out the inside the body of his instrument (the box) and this time, the sound began to resonate.

Youssefzadeh [8] gives a version of the story told by the Turkmen bard, Barat Ali Yegāne from Daregaz in Khorāssān, in which the elements of the two previous stories (the hollowing out of the body and the idea of the nut attributed to Satan) are combined. In this story, the manufacturer is still the character of Bābā Qanbar, the squire of Hazrat-e Ali.

The Different Phases of Making a Dotār

The basics of manufacturing the dotār are largely the same in Khorāssān (east and north) and in the Turkmen tradition in the neighbouring province of Golestan. As an example, the procedure for making a dotār as practiced in north Khorāssān is explained here, step by step³.

- 1 After selection, the mulberry wood is cut into a cylinder [Fig.3, image 1].
- 2 The trunk is cut in four (or five if it is large).
- 3 The body is cut from one quarter of the trunk.
- 4 The body is scraped and planed from the outside.
- 5 The inside of the body is hollowed out and scraped. This phase can be done using hand tools, or first with a machine and then finished by hand. Some luthiers use chisels and different sizes of adzes (called *kolpek*), from short and wide to long and thin as the hollowing out process continues. This is the case for luthier Haddad Kargar Gelyani in Shirvān. The final finishing is very delicate, because the desired thickness can easily be lost. This work is always done using a curved carving chisel (called *lyse* by some musicians).
- 6 The neck, often made from apricot wood, is planed. However, the final finishing is done once the neck is attached to the body.
- 7 The neck and the body are glued together. A special wood glue (called *chasb-e chub* in Persian) is used to join the two parts.

³ The numbers refer to the corresponding images in Fig.3.

Fig.3

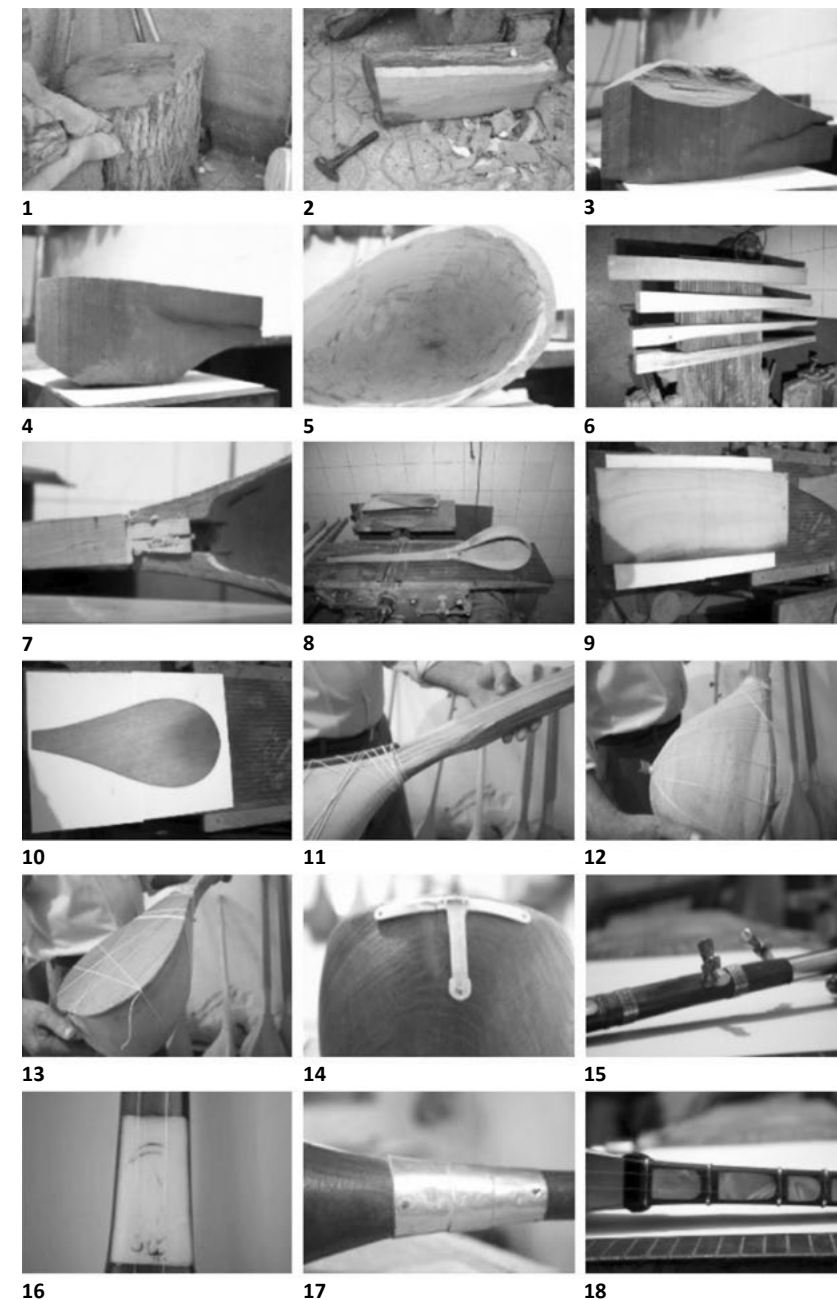

Fig.3 The different phases of making a dotār

- 8 The final result is set aside for a time, to allow the glue to dry.
- 9 The soundboard, also made from mulberry, is already half-prepared (dried and cut in a rectangle). It may be heated slightly with a heater before being mounting on the body, to ensure that all moisture is gone.
- 10 The contour of the junction (of the body and the soundboard) is drawn on the board in pencil and then cut with a coping saw.
- 11 The soundboard is glued to the body. The glued parts are held by cotton ropes that keep the two parts firmly pressed together.
- 12 The hole on the back of the instrument is used to attach the ropes with the help of a pin.
- 13 Once the parts are bonded together, the ropes are removed. Final finishing is done on all parts (board, neck, etc.)
- 14 The next step is to assemble the mounting parts such as the tail-piece, pegs, nut and bridge. The tailpiece is normally fixed with glue and small nails. The pegs, prepared beforehand, will be placed in the two holes made for this purpose in the top of the neck. The nut and bridge are also placed in their respective locations. The instrument is fretted and stringed and finally ready to be played. Although being a good luthier does not necessarily mean one is a good musician, all luthiers are somehow able to play a few tunes on the dotār. For the final phase, the luthier plays for a while on the instrument to ensure that everything is in the right place, and to hear the overall sound quality of the instrument. According to several luthiers, this is a highly anticipated moment, and one of the most decisive. They say that in spite of all their care at every stage, the final sound quality is a last-minute surprise.
- 15 Decoration with metallic motifs, inlays in bone or shell, hooping / with metal rings, etc. are created after manufacturing and sometimes even after a period of use. It is difficult to say whether an instrument will be a high-quality piece as long as it is still young.
- 18 Indeed, one must let the wood age a little. Before beginning the meticulous decorative work and creating inlays, luthiers wait a while for the instrument to demonstrate its sound quality.

Tools

Like the manufacturing procedures, the tools used for making dotārs may vary from one region to another and according to each master. In the northern region of Khorāssān, the musician-bard bakhshis were themselves makers of their own instruments. Being both musician and luthier was considered by many musicians an important ability for becoming a bakhshi. Nowadays, these two functions seem to be more and more separate, considering the number of non-maker musicians and the growing

Fig.4



demand for dotārs in the region. Luthiers also use modern tools and machines to produce more instruments in a shorter period of time (compared to traditional manufacturing, which was a time-consuming activity). Mohammad Yeganeh's workshop, with his sons and few employees, is radically different from the simple courtyard of their house where his father Hossein Yeganeh, the great bakhshi of northern Khorāssān, once crafted his instruments alone (his productions are highly appreciated still today). The use of machines, as is the case with some Turkmen and northern Khorāssāni luthiers, is not very common in eastern Khorāssān. Sometimes luthiers use drill and scraper bits to hollow out the body. Zolfaghar Askarian uses this technique especially for large bodies. In this case, the tip of the bit leaves its marks inside the body.

Some luthiers are reluctant to incorporate the use of machines into dotār-making. Esfandiar Tokhmkar, luthier at Torbat Jām in Eastern Khorāssān, believes that the use of a scraper to hollow out the body, especially in the final stages, presses wood particles and wood powder into the tiny holes and orifices in the wood, which in his opinion means the instrument will not produce a good sound. He continues to complete the entire process of hollowing out the body, often a tedious task, with the help of hand tools such as digging bars (see 2nd and 9th tools from left in Fig.4, right) and curved chisels (4th and 8th tools from left in Fig.4, right). When scraping inside the body, he fixes the wood in a hole in the ground (Fig.4, left) which provides him with sound feedback that tells him how far he must go on scraping. In the final finishing phase, to ensure that the thickness of the body is uniform, he puts one hand outside the body while scraping with a curved chisel from inside. To him, the use of machines does not give him feedback on the vibration.

Fig.4 The hole in the ground used to fix the body when scraping from the inside (left). The traditional tools for dotār-making, used by Esfandiar Tokhmkar, luthier at Torbat Jām in Eastern Khorāssān (right).

Fig.5

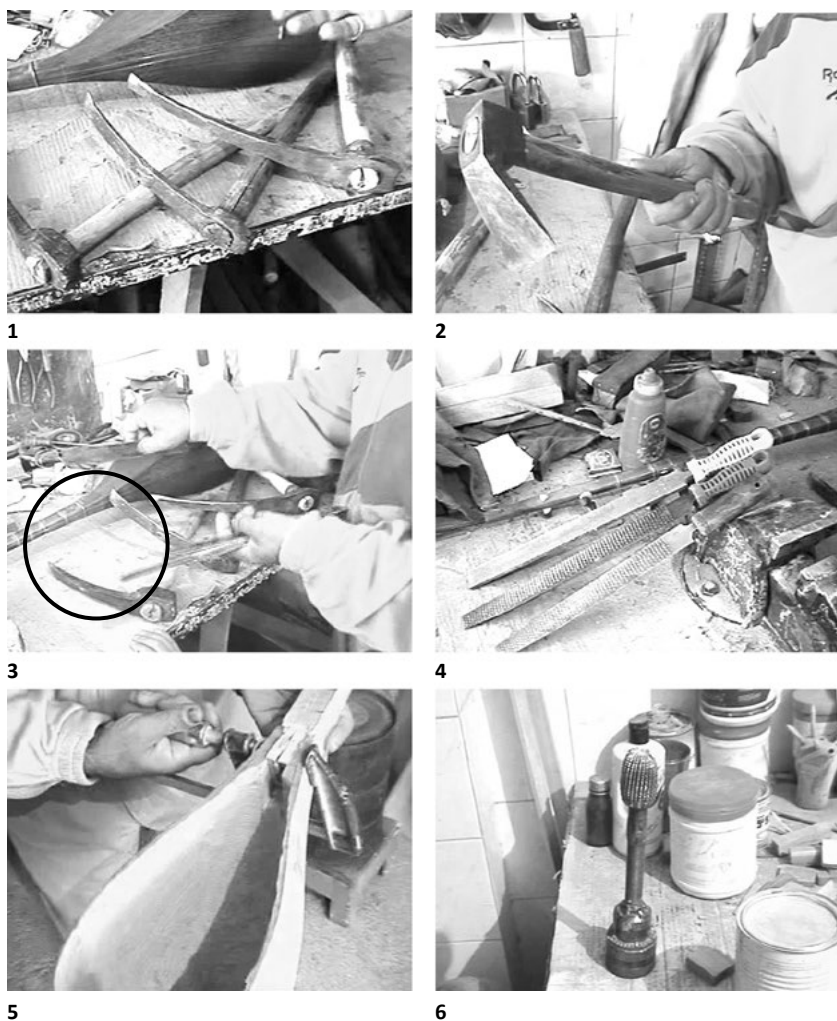

Fig.5 The tools used in making dotārs at the workshop of Haddad Kargar Gelyani, a luthier and musician of Gypsy origin, in Shirvan.

In terms of the process, dotār-making traditions do not vary widely in northern and eastern Khorāssān. Differences are sometimes reflected in the fact that modern woodworking tools are rarely used by luthiers in the east. The metalwork common among Turkmen and luthiers of Gypsy origin is also rare in this region.

The use of different tools in northern Khorāssān also depends on each luthier and which line of manufacturers he belongs to. Gypsy origin luthiers use a wide variety of tools distinguished by size as they proceed in the making process, and in relation to each step of production. Machines are used to varying degrees, depending for example on the number of orders a luthier receives. Machines may be used in the cutting phase, as well as for hollowing out the body and for scraping and polishing the soundboard, body and neck. For some of these tasks, luthiers may call on other craftsmen such as carpenters. Haddad Kargar Gelyani sends the boards for future tables to carpentry workshops to have them polished (*gondegi*) and to obtain the desired thickness.

Wood Treatment

Even if the basic production processes and main materials used for making dotārs are largely the same between the different traditions in this study, the results in terms of sonority and the acoustic characteristics of the instruments vary from one tradition to another. Moreover, with regard to musical acoustics, as Se Golpayegani mentions in a study of white mulberry in the fabrication of Iranian lutes, white mulberry cannot be considered as of the same “standard” as the classical European species.

If we insist on low damping and high modulus as requirements for picking a high-quality wood (which are essential for a wood of superior quality in violin fabrication for example), then white Mulberry (like some other hardwoods used in Asian instruments) would be qualified as “poor”. This is of course not the case, as instruments are fabricated from it and widely played in the region. The reason for such an incompatibility might be attributed to various tastes in musical sounds. In fact, the type of sound produced by an Asian instrument could be very different and not desirable in a European one (and vice versa) [9].

The white mulberry has high natural resistance against fungi and termites [10]. Also, its anatomical features make it an excellent wood in terms of sound quality. The high percentage of fibre in the structure, the high fibre length and appropriate cell wall thickness indicate a good ability for sound transition in this wood [11]. A broader study on non-occidental long-necked lutes [12] shows that there is also a compatibility between historical and recent lutes in use in Asia in terms of vibration and geometric characteristics.

Before manufacturing the body, the wood must be dry enough to allow the luthier to dig easily into the wood. Once again, each luthier has his own approach and methods. Mohammad Yeganeh, luthier in Mashhad, Northern Khorāssān, sets the wood aside in his workshop (or preferably under animal manure) for almost a year (*sālgasht*) before starting to work on it. Esfandiar Tokhmkar, on the contrary, prefers to begin the hollowing out phase when the wood is still fresh. Pre-treating the wood by immersing it in water, as is done for other long-necked Iranian lutes [13], was not observed in the case of the dotār family.

Regarding dotār production techniques, a feature specific to the Turkmen tradition is the special treatment of the mulberry planks that will later be used as the soundboards. In this tradition, the luthiers dry the mulberry boards in a recently turned off oven (*tandur*). Some musicians claim this is probably the origin of the Turkmen name of the instrument: *tamdera*⁴. According to Yusuf Dibāii, a Turkmen luthier in Gonbad-e Kavus, the best temperature for drying is in an oven that has just been turned off at the end of the baking process. Some luthiers use electric ovens, which allow them to quickly dry several boards at the same time. The use of an electric oven also avoids the unpleasant smell that emanates from the boards during the drying period. According to Dibāii, the smell was a source of complaint among the bakers with whom luthiers once partnered to dry the boards.

Fig.6

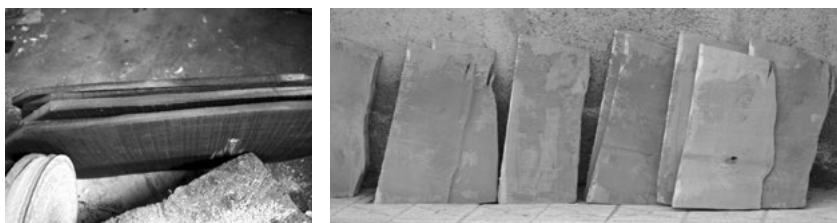

Dotār fabrication in Central Asia follows approximately the same process as for Khorāssāni dotārs. The main difference between a Central Asian (Tajik-Uzbek) dotār and a Khorāssāni or a Turkmen dotār is the material for the strings, which are made from silk or synthetic materials like nylon instead of metal. Another important difference is the fact that the body of the Tajik-Uzbek dotār is not monoxyllic and is made from curved ribs of mulberry wood glued together. These differences

⁴ This hypothesis does not seem plausible. The term *tamdera* instead seems to be related to *tanbur*, an ancient generic name for the family of lute, as mentioned above.

Fig.6 Baked mulberry planks for the Turkmen dotār soundboard (left) and sun-dried mulberry planks at Torbat Jām east of Khorāssān (right).

Fig.7



Fig.7 Uzbek maker Anvar Zufarov in front of his stock of mulberry wood at his workshop in Tashkent (Photo by Farrokh Vahabzadeh, Tashkent, Uzbekistan, 2017).

result in a completely different sonority compared to the other variants of dotār studied earlier.

It should be mentioned that the acoustic characteristic of the dotār in each tradition is a result of its organology, using specific materials and applying different production strategies. From an ethnomusicological point of view, this sonority is related to a culture's ethnoaesthetic sound preferences, which goes along with particular playing techniques. As an example, the Turkmen dotār (with a “baked” soundboard) possesses the tiniest and smallest bridge of all the instruments in the dotār family. This means the fingers touch the soundboard easily while playing, which creates a percussive/scraping effect when the strings are plucked. In contrast, the bridge height on the eastern Khorāssān dotār (with its sun-dried soundboards) does not allow the fingers to easily touch the board. Some musicians from this region also mentioned that one must take care not to scrape the soundboard with the fingernails or fingers when playing. At this stage, it is difficult to conclude whether a musical tradition develops particular playing techniques in order to reach a particular sonority, or rather it is the combination of a series of playing gestures with a particular organology that creates the instrument's sonority.

Conclusion

In this paper, we have tried to offer an anthropological approach to the study of the relationship between music and environment, especially with regard to the mulberry tree and instrument-making in the province of Khorāssān in Iran and in Central Asia. A complete study of a musical tradition with regard to instrument-making demands an interdisciplinary approach to the subject with innovative methodology combining anthropology, ethnomusicology, acoustics and wood science. The local beliefs and know-how about the music and the surrounding environment have an important role in understanding a musical tradition and a culture's perception of the world. At present, our knowledge of musical acoustics, anthropology and ethnomusicology do not allow us to analyse and completely decode all of the local know-how, but research continues to reveal important information about the ethno-aesthetics of a tradition and its physical and metaphysical universe.

References

- [1] F. Vahabzadeh, "Se démarquer de l'autre : du geste instrumental à la corporalité musicale," in M. Desroches, S. Lacasse, and S. Stévançe (Eds.), *Quand musique prend corps*. Montreal: PUM, 2014, p. 63-78.
- [2] F. Vahabzadeh, "Étude comparative des gestes instrumentaux : Le jeu du dotâr en Iran et en Asie centrale," *Musicultures*, vol. 32, no. 2, 2012, pp. 141-160.
- [3] A.-N. Fārābī, "Kitab al-Musiqi Al-Kabir," in *La Musique Arabe : T. 2.*, B. R. d'Erlanger and P. Geuthner (Trans.), 1930.
- [4] Z. Hussaynī, "Al-Abedin Mahmud," in *Qānun-i Ulmi va Amali-e Musiqi*. Dushanbe: Nashriyat-e Danesh, 1986.
- [5] S. Mubalieva, "Mulberries, The fruit from paradise," in F. Van Oudenhoven and J. Haider (Eds.), *With Our Own Hand, A Celebration of Food and Life in the Pamir Mountains of Afghanistan and Tajikistan*. LM Publishers, 2015, p. 206-210.
- [6] V. M. Beliaev and V. Uspenskii, *Turkmen-skaia muzyka*. Moscow: Gosudarstvennoe izdatel'stvo, muzykal'nyi sektor, 1928.
- [7] M. Slobin, *Music in the Culture of Northern Afghanistan* (Viking Fund Publications in Anthropology). University of Arizona Press, 1976.
- [8] A. Youssefzadeh, *Les bardes du Khorasan iranien : le bakhshi et son repertoire*. Paris: Peeters / Institut d'études iraniennes, 2002.
- [9] A. Se Golpayegani, "Caractérisation du bois de Mûrier blanc (*Morus alba* L.) en référence à son utilisation dans les luths Iraniens." Presented at Université Montpellier II – Sciences et Techniques du Languedoc.
- [10] A. Se Golpayegani, M.-F. Thévenon, I. Bremaud, K. Pourtahmasi, and J. Gril, "Natural durability and dimensional stability of white mulberry (*Morus alba* L.) for Middle Eastern lutes," *Madera Bosques* 23(2), pp. 193-204, 2017.
- [11] K. Pourtahmasi and A. Se Golpayegani, "Introducing Mulberry's wood (*Morus alba* L.) used in bowl shaped musical instruments of Iran," Proc. 2009 study day "Le bois : instrument du patrimoine musical," Cité de la Musique, Paris, pp. 78-87.
- [12] H. Boutin, F. Vahabzadeh, S. Le Conte, and P. Bruguière, "Historical and contemporary non-occidental long-neck lutes: Relationships between making strategies and musical aesthetic," Proc. 2016 3rd COST FP1302 WoodMusICK Conf., *Making wooden musical instruments: An integration of different forms of knowledge*, Museu de la Música, Barcelona, pp. 31-35.
- [13] A. Se Golpayegani, I. Bremaud, M.-F. Thévenon, K. Pourtahmasi, and J. Gril, "The effect of traditional hygro-thermal pretreatments on the acoustical characteristics of white mulberry wood (*Morus alba*)," in *Maderas, Cienc. Tecnol.*, vol. 17, no. 4, 2.

This publication is based upon work from COST Action FP1302 WoodMusICK (WOODen MUSical Instrument Conservation and Knowledge), supported by COST (European Cooperation in Science and Technology).

COST is a funding agency for research and innovation networks. Our Actions help connect research initiatives across Europe and enable scientists to grow their ideas by sharing them with their peers. This boosts their research, career and innovation. www.cost.eu

Illustrations: Front cover, Picasso, *Violon*, 1913-1914 (C) RMN-Grand Palais (Musée national Picasso-Paris) / Béatrice Hatala / Succession Picasso 2018;

Back cover, Spruce soundboard of classical guitar (3D-reflected-light microscopy image, fig.7 p.149) © Volker Haag

Layout: Lilli Lacombe

Printed in October 2018 by Présence Graphique, 37260 Monts

Printed in France