



HAL
open science

Application of the Bond Graph Privileged Frame Representation to the Example of a Delta Robot

Wilfrid Favre, Serge Scavarda

► **To cite this version:**

Wilfrid Favre, Serge Scavarda. Application of the Bond Graph Privileged Frame Representation to the Example of a Delta Robot. CESA '96, IMACS Multiconference, Symposium on Modelling Analysis and Simulation, Jul 1996, Lille, France. pp.518-522. hal-02064838

HAL Id: hal-02064838

<https://hal.science/hal-02064838v1>

Submitted on 12 Mar 2019

HAL is a multi-disciplinary open access archive for the deposit and dissemination of scientific research documents, whether they are published or not. The documents may come from teaching and research institutions in France or abroad, or from public or private research centers.

L'archive ouverte pluridisciplinaire **HAL**, est destinée au dépôt et à la diffusion de documents scientifiques de niveau recherche, publiés ou non, émanant des établissements d'enseignement et de recherche français ou étrangers, des laboratoires publics ou privés.

Application of the Bond Graph Privileged Frame Representation to the Example of a Delta Robot

Wilfrid FAVRE - Serge SCAVARDA
Laboratoire d'Automatique Industrielle
Institut National des Sciences Appliquées de Lyon - Bât. 303
20, avenue Albert Einstein 69621 VILLEURBANNE Cedex
France
e-mail: Wilfrid.Favre@laifluide2.insa-lyon.fr
Tel.: (33) 72 43 83 41
Fax: (33) 72 43 85 35

Keywords: Bond graph, multibody mechanical systems, kinematic loops, privileged frame representation

Abstract

This paper compares the Tiernego and Bos procedure to that of the privileged frame representation for the bond graph representation of multibody mechanical systems with kinematic loops. This comparison is carried out using the example of a Delta Robot.

The privileged frame representation procedure that we have recently developed is systematic since no analytical derivation is necessary to build the bond graph and this procedure aims at a more concise representation which may help the analytical and structural exploitation.

This procedure is based on the detection of privileged frames on the kinematic loops of mechanical systems. After this detection process, both effort and flow variables attached to the junction structures of bodies involved in the kinematic loops, are expressed in those frames.

1. Introduction

Bond graph representation of multibody mechanical systems has several approaches.

First, bond graph construction was carried out using kinematic relations by Karnopp and Rosenberg [1], [2], [3] and by Allen and Dubowsky [4]. Brown [5], [6] developed a representation from re-writing Lagrange's equations. Later Tiernego and Bos [7], [8], [9], [10] and [11], systematized bond graph representation directly through kinematics. More recently Zeid and Chung [12] proposed, in similar way, a directly graphic bond graph construction.

In this paper, we propose also a systematic procedure at a graphic level. It treats notably multibody mechanical systems with kinematic loops. This method is based on the notion of privileged frame representation and is compared to the Tiernego and Bos procedure using the example of the Delta Robot.

The context is classical mechanics and only rigid bodies are considered in the multibody mechanical systems. However there is no restriction either to integrate partial bond graphs representing non-rigid bodies or to connect bond graphs of other domains.

2. Privileged frame Representation

The Tiernego and Bos procedure is based on both the body and the joint bond graph representations and then their linking. The body kinematic for each body is expressed in its own frame. This results in modulated transformers between body junction structures. In his Ph. D. thesis Bos indicates,

concerning kinematic loops, that these "[...] loops had to be cut because the derivation of equations from multibody systems including loops does not always fit the description presented [...]" ([11] - p.107). And he closes them afterwards analytically in the mathematical model.

The privileged frame representation [13] is a result of this acknowledgement of semi-failure concerning the multibody systems with kinematic loops. So the question is why the analytical mechanical approach is not confronted with these difficulties. The reason can be found in an "intuitively mechanical" approach. This consists of expressing the constraint in a unique frame so that the relations are as simple as possible.

So the privileged frame representation is based on the expression of the body kinematic in a unique and same frame for the bodies involved in a kinematic loop. This is illustrated in the figure 1 sketch.

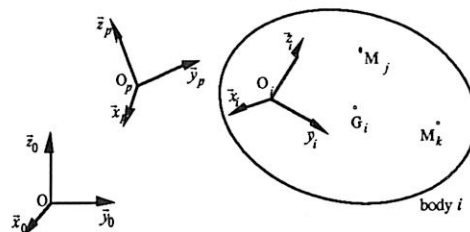

Figure 1 - Illustration of the different frames: inertial of reference (0), body frame (i), and privileged frame (p)

As previously mentioned we call this frame (denoted p) the privileged frame. As a result the corresponding junction structures have variables expressed in this frame. The rotational dynamic part remains expressed in the body frame and the translational dynamic part remains expressed in the inertial frame of reference. This is shown in the figure 2 bond graph [13] of the figure 1 spatial moving body. As a consequence the modulated transformers between the body junction structures will be removed while connecting bond graphs of bodies involved in a kinematic loop.

The procedure for constructing the bond graph representation of multibody mechanical systems can be summarized in the following steps:

- detect the possible kinematic loops,
- attach a privileged frame to each of them,

- build the bond graph representation of the bodies taking into account the possible privileged frames for each junction structure,
- build the bond graph representation of the joints,
- assemble both the body and the joint bond graphs,
- apply simplifications to the final graph if necessary.

The three first points are essentially new compared with the Tiernego and Bos Procedure.

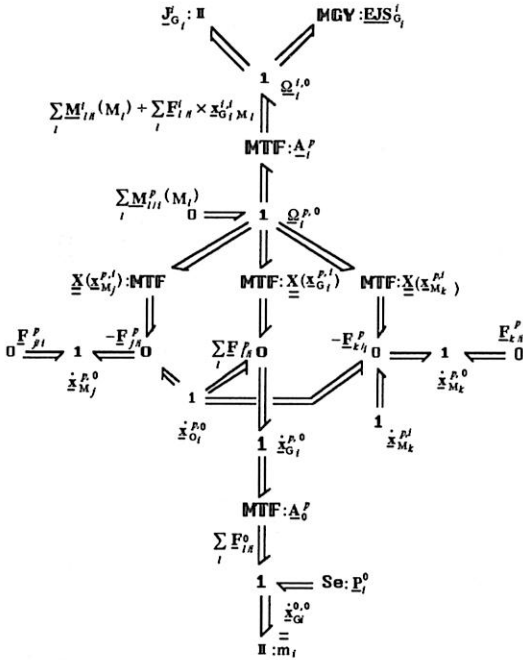

Figure 2 - Bond graph of the spatial moving body

The choice of privileged frames could be highly complicated depending on the criteria announced. The steps given below usually lead to the optimal choice i. e. to the privileged frame in which the kinematic constraints have the simplest relations when obtained by the mechanical approach.

For one kinematic loop, a privileged frame will be chosen:

- (i) among those frames of the bodies involved in the loop,
- (ii) from the body globally nearest¹ to all the others in the loop,
- (iii) if the privileged frames are still undetermined, choose the ones which are nearest to one another and finally,
- (iv) if several candidates remain for some loops, choose the nearest to the inertial frame of reference.

Before considering the example of the Delta Robot we give some definitions which will serve for the conciseness of the following.

Definition 1: A *direct coordinate transformation* is a coordinate transformation directly issued from the parametrisation in the system description.

Definition 2: A *n-degree coordinate transformation* is a coordinate transformation involving n direct coordinate transformations. So n is the degree of transformation.

¹ By the nearest we mean frames which require few coordinate transformations between them.

Definition 3: The coordinate transformation corresponding to a translation is of *degree 0*.

3. Application to the example of the Delta Robot

The Delta Robot system

The Delta Robot has been chosen for two main reasons. On one hand simply because it is a good example of the parallel robot concept. It was introduced by Clavel [14] and one may notice its remarkable performance when used by Badano [15]. On the other hand it represents an appropriate multibody mechanical system for testing a bond graph representation procedure. Moreover it possesses a non-trivial 3D aspect and several kinematic loops.

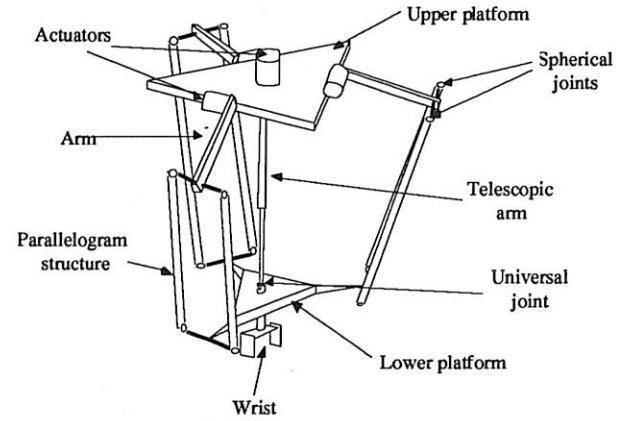

Figure 3 - Physical sketch of the Delta Robot

The Delta Robot physical sketch is shown in figure 3 and its complete description is given by Clavel [14]. It consists of two platforms linked together by three identical arms placed at 120° around both platforms. Each of them is composed of one arm and a parallelogram structure. So they impose a translational motion to the lower platform with respect to the upper one. Finally a central structure allows the wrist to rotate around a vertical axis. The robot has then four degrees of freedom.

In the bond graph representations we assume rigid bodies and ideal joints. Compliances and dissipations would not change the test validity so they will not be taken into account. Finally we consider that frames, geometry, mass and motion parameters of bodies in the system are known.

In subsequent analysis it is important to be aware of which bodies are parametered with respect to others and also what is the "degree of transformation" between coordinate systems. In the Delta Robot and according to Clavel's description, the arms and the links of the parallelogram structures are parametered with respect to the upper platform. We admit without demonstration that the lower platform translates with respect to the upper one. The wrist is parametered with respect to the lower platform. Finally the links (constrained by a prismatic joint) of the telescopic arm are parametered with respect to the upper platform.

Bond graph representations

The application of our procedure to the Delta Robot has led us to consider the figure 4 kinematic loops. The way these loops have been chosen here is not our main interest. There is no unique choice but a little practice will help to avoid bad choices. A good approach is:

- (i) start from the body associated to the inertial frame of reference and follow a body path back to it without passing more than once through the same body,
- (ii) repeat (i) until all bodies are involved in kinematic loops (when possible),
- (iii) if there remain bodies not involved in a kinematic loop, either they constitute a kinematic opened chain and can be left apart or there remain kinematic loops not involving the body associated to the inertial frame of reference, then restart point (i) with another initial body as near as possible to the inertial frame of reference.

It is worthwhile noting that it might be practical to include in a privileged representation some bodies belonging to kinematic opened chains in particular when they are parametered with respect to the same body.

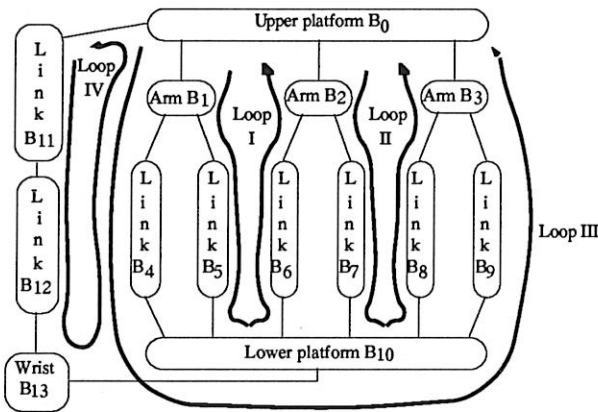

Figure 4 - Sketch of the kinematic loops for the Delta Robot

Once the kinematic loops have been drawn, a privileged frame must be attached to each of them. This is achieved by following the steps of the procedure given earlier. Help may be found in the figure 5 graphs associated to each loop. They represent the direct coordinate transformations (definition 1)

issued from the system description between the bodies involved in a loop. Vertices represent the bodies and edges represent parametrisation. The latter are suppressed for 0-degree coordinate transformations (definition 3). It can be noticed that no coordinate transformation of degree greater than two (definition 2) is present in the system.

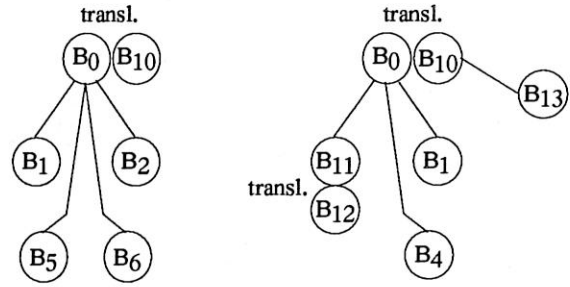

Figure 5 - Loop graphs displaying the coordinate transformations between bodies

The first graph is valid for loops II and III as well (with corresponding bodies) and allows the inertial frame of reference to be chosen as the privileged one for these loops. This is concluded after step (ii) of the procedure. The second graph shows also B_0 as the privileged frame for loop IV.

So we have chosen the frame attached to the upper platform (inertial frame of reference) as the privileged frame for each loop.

Now the bond graph can be constructed. We first establish bond graphs of bodies and joints taking into account the privileged frame representation for the junction structures. We assemble the obtained partial bond graph applying simplifications due to the peculiarities of the system. Finally the final bond graph is displayed in figure 6.

The bond graph obtained with the Tiemego and Bos procedure is shown in figure 7 in order to compare both representations.

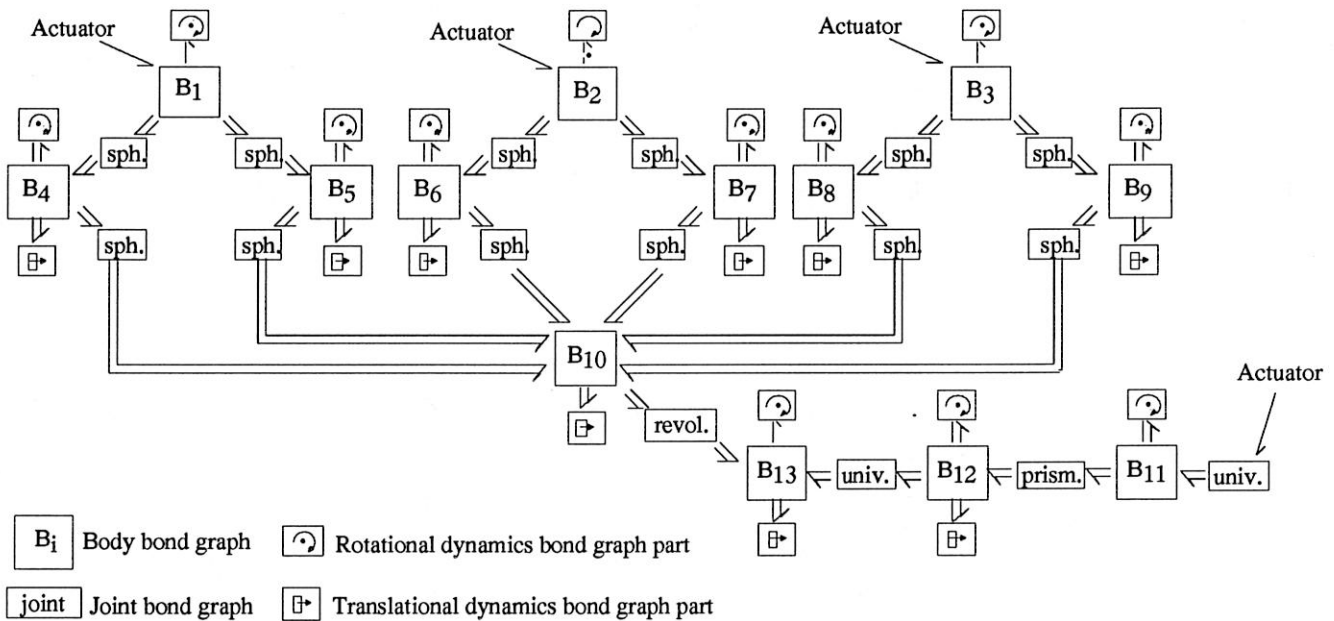

Figure 6 - Word bond graph of privileged representation

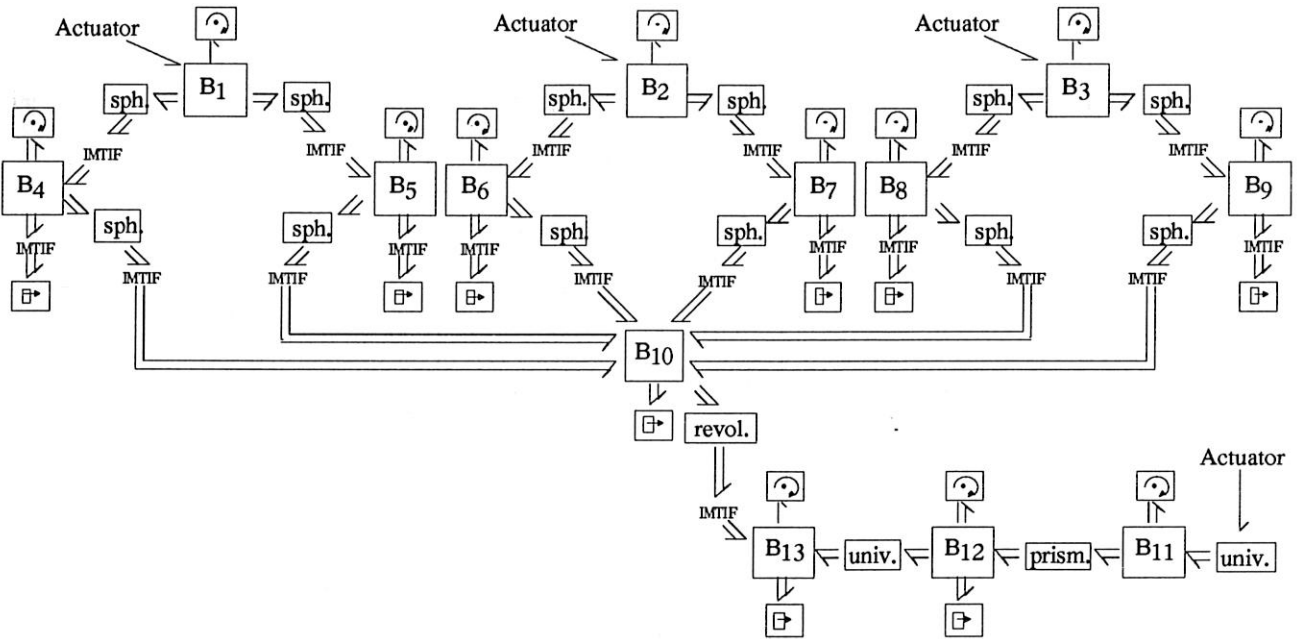

Figure 7 - Word bond graph of Bos' representation

The first remark is of course the disappearance of the modulated transformers between the body junction structures and also between the latter and the translational dynamic parts. However a more precise observation shows that the transformers present in the junction structures are more complex. So, to undertake an objective comparison, we consider only the structural aspect of the bond graphs. We can notice that about 20% of the transformers have been globally removed on this bond graph representation using our method compared to that of Tiernego and Bos.

This is important for several reasons:

- at the Word Bond Graph level, the privileged frame representation is simpler and favours a structural analysis,
- from a computer-aided analysis point of view, the graphic input is lighter with the privileged frame representation,
- finally the multiplication of transformers may add causal cycles which might be inconvenient to the derived simulation model [16].

4. Conclusion

In this paper we propose a procedure for building bond graphs of multibody systems with kinematic loops. The privileged frame representation takes into account, from a global point of view, kinematic loops of the system compared to the Tiernego and Bos procedure which is a local approach to the system bodies. This procedure is systematic, accessible to non-specialists and may be used in computer programming.

In the case of systems possessing no kinematic loop but having several bodies parametered with respect to one another, we can gain advantage using the privileged frame representation. Moreover we can consider the Tiernego and Bos procedure as a particular case of our procedure where no kinematic loop would be detected, for example arborescent structures in robotics.

Finally, concerning the implicit DAE aspect of the resulting simulation model, compliances and dissipations may be introduced as has already been carried out before [17], [18],

[19], [20], [21]. However, we are convinced that with the increasing performance of DAE solvers [22], the direct use of the privileged frame representation will prove beneficial.

5. References

- [1] Karnopp, D. C. Power-conserving transformations: Physical interpretations and applications using bond graphs. *Journal of the Franklin Institute*, 1969, vol. 288, n° 3, p. 175-201
- [2] Rosenberg, R. C. Multiport models in mechanics. *Journal of Dynamic Systems, Measurement, and Control*, 1972, vol. 94, n° 3, p. 206-212
- [3] Karnopp, D. C., Rosenberg, R. C. *System dynamics : a unified approach*. New York : John Wiley & Sons, 1975. 402 p.
- [4] Allen, R. R., Dubowsky, S. Mechanisms as components of dynamic systems: a bond graph approach. *Journal of Engineering for Industry*, 1977, vol. 99, n° 1, p. 104-111
- [5] Brown, F. T. Lagrangian bond graphs. *Journal of Dynamic Systems, Measurement, and Control*, 1972, vol. 94, n° 3, p. 213-222
- [6] Brown, F. T. Bond graphs for nonholonomic dynamic systems. *Journal of Dynamic Systems, Measurement, and Control*, 1976, vol. 98, n° 4, p. 361-366
- [7] Tiernego, M. J. L. Bond graph modelling and simulation techniques applied to a three axis driven pendulum. *International Journal of Modelling & Simulation*, 1981, vol. 1, n° 1, p. 62-66
- [8] Tiernego, M. J. L. A new systematic bond graph modelling procedure for 3-D mechanics. Applied to robotics. *Proceedings of the 10th IMACS World Congress of System Simulation and Scientific Computation*, Aug. 8-13 1982, Montreal, Canada, 1982, vol. 3, p. 392-394
- [9] Tiernego, M. J. L., Bos, A. M. Modelling the dynamics and kinematics of mechanical systems with multibond graphs. *Journal of the Franklin Institute*, 1985, vol. 319, n° 1/2, p. 37-50

- [10] Bos, A. M., Tiernego, M. J. L. Formula manipulation in the bond graph modelling and simulation of large mechanical systems. *Journal of the Franklin Institute*, 1985, vol. 319, n° 1/2, p. 51-65
- [11] Bos, A. M. Modelling multibody systems in terms of multibond graphs. Ph.D. Thesis : Electrical engineering : University of Twente, Enschede, Netherlands, 1986. 225 p.
- [12] Zeid, A., Chung, C. Bond graph modeling of multibody systems : a library of three-dimensional joints. *Journal of the Franklin Institute*, 1992, vol. 329, n° 4, p. 605-636
- [13] Favre, W., Scavarda, S. Bond graph representation of multibody systems with kinematic loops. Submitted to the *Journal of Franklin Institute*. 1996.
- [14] Clavel, R. Conception d'un robot parallèle rapide à quatre degrés de liberté. Ph. D. Thesis: Département de Microtechnique: Ecole Polytechnique Fédérale de Lausanne, Lausanne, Suisse, 1991. 131 p.
- [15] Badano, F. Contribution au développement d'une méthodologie d'assemblage automatisé par approche stochastique et compliance. Application à l'insertion de pièces cylindriques sans chanfrein. Ph. D. Thesis : Génie Mécanique Construction : Institut National des Sciences Appliquées de Lyon, Lyon, France, 1993.
- [16] Van Dijk, J. On the role of bond graph causality in modelling mechatronic systems. Ph.D. Thesis : Electrical engineering : University of Twente, Enschede, Netherlands, 1994. 220 p.
- [17] Karnopp, D. C., Margolis, D. L. Analysis and simulation of planar mechanism systems using bond graphs. *Journal of Mechanical Design*, April 1979, vol. 101, p. 187-191
- [18] Zeid, A. An algorithm for eliminating derivative causality. *Proceedings ASME Winter Annual Meeting, Automated Modelling for Design*, Chicago, Il., USA, 1988, vol. DCS-8, p. 15-21
- [19] Zeid, A. Bond graph modeling of planar mechanisms with realistic joint effects. *Journal of Dynamic Systems, Measurement, and Control*, 1989, vol. 111, n° 1, p. 15-23
- [20] Zeid, A., Overholt, J. L. Singularly perturbed bond graph models for simulation of multibody systems. *Journal of Dynamic Systems, Measurement, and Control*, 1995, vol. 117, n° 3, p. 401-410
- [21] Zeid, A., Overholt, J. L. Singularly perturbed formulation: Explicit modeling of multibody systems. *Journal of the Franklin Institute*, 1995, vol. 332B, n° 1, p. 21-45
- [22] Imagine, 1995, A course on the numerical aspects of simulation of engineering systems, private edition.