



**HAL**  
open science

## Characterization and modeling of a proportional valve for control synthesis

Osama Olaby, Xavier Brun, Sylvie Sesmat, Tanneguy Redarce, Eric Bideaux

► **To cite this version:**

Osama Olaby, Xavier Brun, Sylvie Sesmat, Tanneguy Redarce, Eric Bideaux. Characterization and modeling of a proportional valve for control synthesis. 6th JFPS International Symposium on Fluid Power, Nov 2005, Tsukuba, Japan. 10.5739/isfp.2005.771 . hal-02063811

**HAL Id: hal-02063811**

**<https://hal.science/hal-02063811v1>**

Submitted on 20 Mar 2019

**HAL** is a multi-disciplinary open access archive for the deposit and dissemination of scientific research documents, whether they are published or not. The documents may come from teaching and research institutions in France or abroad, or from public or private research centers.

L'archive ouverte pluridisciplinaire **HAL**, est destinée au dépôt et à la diffusion de documents scientifiques de niveau recherche, publiés ou non, émanant des établissements d'enseignement et de recherche français ou étrangers, des laboratoires publics ou privés.

# CHARACTERIZATION AND MODELING OF A PROPORTIONAL VALVE FOR CONTROL SYNTHESIS

Osama. OLABY, Xavier. BRUN, Sylvie. SESMAT, Tanneguy. REDARCE and Eric. BIDEAUX

Laboratoire d'Automatique Industrielle - <http://www-lai.insa-lyon.fr> –  
LAI, Bât St Exupéry, 25 Av Jean Capelle INSA de Lyon,  
69621 Villeurbanne Cedex, FRANCE  
(E-mail: [osama.olaby@insa-lyon.fr](mailto:osama.olaby@insa-lyon.fr))

## ABSTRACT

This paper presents a global characterization and an analytical model of the static flow stage of an electro-pneumatic proportional valve FESTO MPYE-5-M5-010-B. This study is useful for linear or nonlinear control synthesis in our application for medical robotics. Firstly, the experimental measurements are carried out using 3D graphs where a set of curves gives the output mass flow rate as a function of the electrical input of the electronic stage for different values of the output pressure. The exhaust and supply pressures, during these tests, are assumed to be constant. This characterization leads to a good estimation of the different parameters such as sonic conductance. Moreover, 2D classical curves given by some constructors can be reconstructed, such as mass flow gain, pressure gain and mass flow characterization. Secondly, an approximation of the mass flow stage characteristics of this five-way proportional valve by a polynomial function is described. The model elaborated enables a good reproduction of the pressure gain and the global mass flow characterization curves to be obtained.

## KEY WORDS

Pneumatic proportional valve, Experimental characterization, Modeling.

## I. INTRODUCTION

Pneumatic systems are increasingly present in a number of industrial manufacturing procedures, handling, medical, armament and robotics, etc.

The use of proportional distributors in pneumatic systems has a practical design and simple use, especially to carry out the synthesis of the linear and nonlinear control laws in feedback control, for example position feedback control or force feedback control tracking according to desired trajectories [1]. Moreover, the proportional valve is a power modulator that does not consume much energy [2],[3]. A servo-distributor is known as proportional when it provides a flow rate in bi-directional operating mode. The flow rate delivered by the servo-distributor (either forward or return) is a

function of the input voltage of the electronic stage of the proportional valve.

FESTO MPYE-5-M5-010B is a proportional valve, 5/3-way function, with a maximum flow rate of about 140 Nl/mn\* at a supply pressure of 7 bar abs\*\*. This mass flow rate is suitable for developing a medical robot (BirthSIM) [4],[5].

BirthSIM is a childbirth simulator developed in collaboration between INSA Lyon (Institut National des Sciences Appliquées) and HCL (Hospices Civils de Lyon) [6]. BirthSIM is a dynamic functional simulator, which takes into account the movement of a baby through its mother's pelvis. In fact this type of simulator will help to teach, in a realistic way, and in complete

---

\*1 Nl/mn = 0.0215 g/s

\*\*Thereafter, all the pressure values expressed in bar, will be in absolute bar.

safety the medical techniques of childbirth in the midwife schools and the Faculty of Medicine. It has been developed to enable obstetricians to learn how to perform the procedure for the first time. The operative part of BirthSIM contains a pneumatic actuator which produces the movement of the head of the newborn and supplies a programmable resistance to the force of traction. The actuator will enable BirthSIM to imitate contractions and the mother's pushing action. This actuator is a linear cylinder, double-acting and single stroke which supports the head of the newborn. This cylinder can position the newborn, and more particularly its head, on a horizontal axis. Two FESTO MPYE-5-M5-010B proportional valve controls this pneumatic cylinder. In order to carry out the automatic piloting of the electro-pneumatic system, it is necessary to know the mathematical model of the power modulator. The control model of FESTO power modulator presented in this paper hasn't enough precise. The robust control will allow to get high performances for the pneumatic system used.

Servo-distributor manufacturers do not provide sufficient characteristics to obtain a model of the flow rate stage of the pneumatic components in their documentation [7]. No characteristics are provided by FESTO. This is why the global static characteristics (port P) of the proportional valve, were established. Moreover, experimental measurements carried out can give a simulation model of the flow rate stage of this proportional valve. These measurements form a table, having as inputs the output pressure and the electrical input of the electronic stage integrated into the proportional distributor and giving the output mass flow rate. The procedures followed to carry out the global characterization of the FESTO proportional valve confirm the possibility of applying a protocol carried out previously for a Servo-distributor of the Asco JOUCOMATIC company [7],[8], to other fluid power components. Servotronic Asco JOUCOMATIC is a three-way electro-pneumatic Servovalve, its maximum flow rate is about of 1400 Nl/mn. This flow rate value is much larger than that of the FESTO MPYE-5-M5-010B proportional valve.

This article is organized as follows: In section II, the FESTO proportional valve is briefly described. In section III, experimental results of a global characterization of this type of pneumatic component is provided. Section IV presents a mathematical model of the static flow rate stage. The results obtained with this model are compared with the experimental results and two types of errors are then discussed.

## II. TECHNIQUE DESCRIPTION OF THE PROPORTIONAL VALVE UNDER STUDY

The MPYE-5-M5-010B proportional valve is a distributor of a type 5/3. It is thus composed of five

ports N, P, S, E and E with three intermediate spool positions (Figure 1). The five ways present an S orifice of compressed air (it is numbered orifice (1) by the manufacturer), two working orifices for P(4), N(2) and two for the exhaust E(3 and 5). If the input control is varied from 0 V to 5 V, the compressed air exits from port (1) towards port (2) and the exhaust goes from port (4) towards port (5). By varying the voltage of 5 V to 10 V, the compressed air exits from port (1) towards port (4) and the exhaust goes from port (2) towards port (3). For a voltage from 5 V, when the spool is in mid-position, the flow rate of the distributor is theoretically invalid.

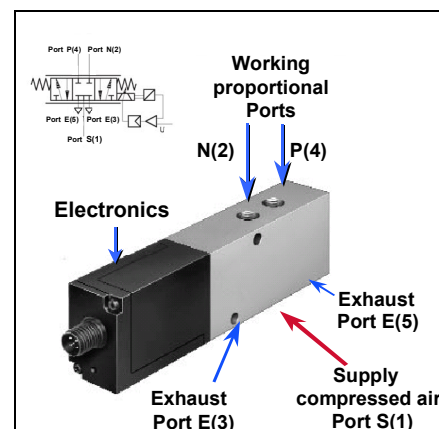

Figure 1. Photograph and schema of a FESTO MPYE-5-M5-010B proportional valve

## III. EXPERIMENTAL CHARACTERIZATION RESULTS

The characterization suggested for the FESTO proportional valve is a global static characterization for the exhaust and supply pressure constants.

- Global since the output mass flow rate is given as a function of both the electrical proportional valve input and of the output pressure.
- Static, because for each variation in the electrical input control or in the output working pressure, the measurement readings (pressure and flow rate) are taken when the flow rate is in established mode.

Figure 2 shows the testing device used for measuring the desired characteristics of the port P(4) when the port N(2) is shut. The experimental procedure consists of recording the output flow rate for each variation of the input voltage and of the working pressure  $P_p$ . It is necessary to vary one of these two independent values and to keep the other constant.

It can be seen from Figure 2 that, for this purpose, the output pressure  $P_p$  and the supply pressure ( $P_s=7$  bar) are kept constant by using two pressure regulators. Considering the nonlinear character of this type of component, it was necessary to make more voltage

measurements between 4 V and 6 V (depending on the function of this proportional valve).

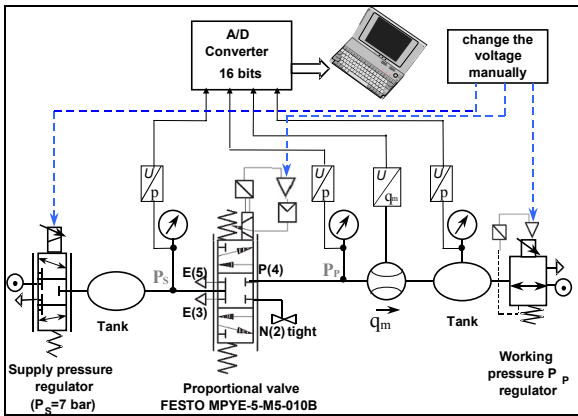

**Figure 2.** Testing device

Figure 3 shows (after having carried out a linear interpolation of the measurement points) the three-dimensional evolution of the mass flow rate as a function of valve-input control and its working pressure. In fact, if this characteristic is projected on two planes ( $U, q_m$ ) and ( $P_p, q_m$ ) the network of mass flow gain (Figure 4) and the network of mass flow rate characterization (Figure 5) can be obtained respectively.

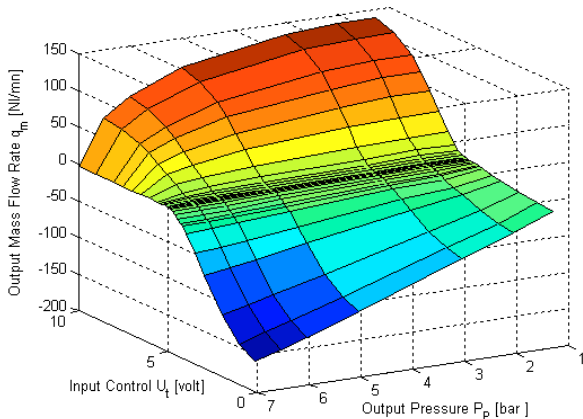

**Figure 3.** 3D-global static characteristics

Figure 4 shows the evolution of the output proportional valve mass flows  $q_m$  as a function of electrical input  $U$ , for eight different values of the output pressure  $P_p$ , distributed from 1.25 to 7 bar. In this figure is shown:

- The non-linearity of the curves for values near the supply and exhaust pressures, for values of input control near the 5V value.
- The eight curves are monotonous.

- A phenomenon of saturation is noticed for the values of input control higher than 8 V and lower than 2V.

The set given in Figure 5 shows the output mass flow rate as a function of the output pressure for 26 different values of the input voltage control from 0.153V to 10V.

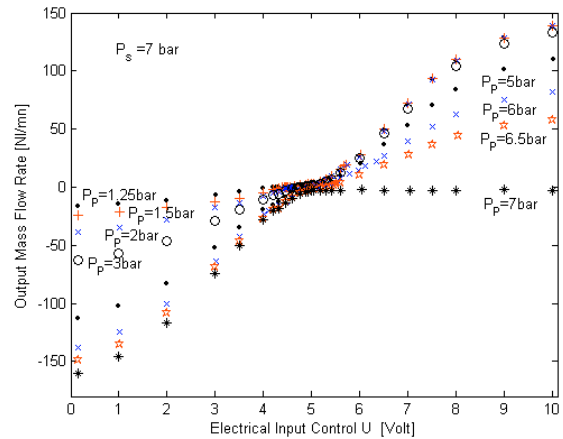

**Figure 4.** Set of mass flow rate curves as a function of proportional valve input

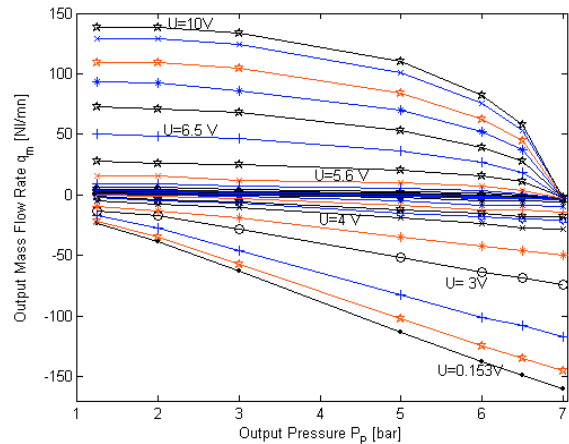

**Figure 5.** Set of mass flow rate curves as function of proportional valve output pressure

This network clearly shows the classical behavior of the Servo-distributor orifices related either to a supply process or to an exhaust process for large absolute values of the valve proportional input control.

The two sets of curves (Figure 4 and 5) determine simply the variation of mass flow rate against both an output pressure  $P_p$  and an input control. This information enables a simulation model of the static flow stage in the form of an easily programmable 3D-table to be used for any simulation.

#### IV. ANALYTICAL CONTROL MODEL

The synthesis of certain control laws requires the knowledge of a model in a mathematical form [2]. The modeling of a servodistributor enables the mass flow rate at its output as a function of the output working pressure, and of the electrical input control to be determined. For the control objective, it is tried to reproduce the static behavior of the FESTO distributor proportional valve, via a mathematical expression.

A method had been proposed, using a mathematical expression of the mass flow rate evolution law, depending on the global characteristics of the servodistributor JOUCOMATIC SERVOTRONIC [8]. This control model for the FESTO proportional valve is validated by carrying out a translation of the valve-input control  $U$  to new values of control  $U_i$ : ( $U_i = 5.0412 \cdot U$ ).

The value equal to 5.0412V (deduced from the measurements) corresponds to the intersection point of the pressure gain characterization orifice P and orifice N. Thus the following mathematical expression is obtained:

$$q_m(U_i, P_p) = \varphi(P_p) + \psi(P_p, \text{sgn}(U_i)) \times U_i \quad (1)$$

- $q_m(U_i, P_p)$  illustrates a mass flow rate (Nl/mn) that is a function of the working pressure  $P_p$  and an input control voltage  $U_i$ .
- $\varphi(P_p)$  is a polynomial function whose evolution corresponds to the mass flow rate leakage (Nl/mn) from the orifice P. It is identical for all input control values  $U_i$  (Figure 6.)
- $\psi(P_p, \text{sgn}(U_i))$  is a polynomial function of the input control sign (Figure 7) because it is different for the inlet ( $U_i > 0$ ) and for the exhaust ( $U_i < 0$ ).

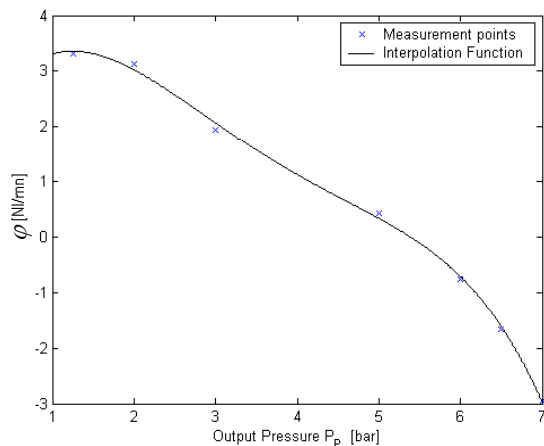

**Figure 6.** Approximation of mass flow rate measured for  $U_i = 0$ : Function  $\varphi(p)$

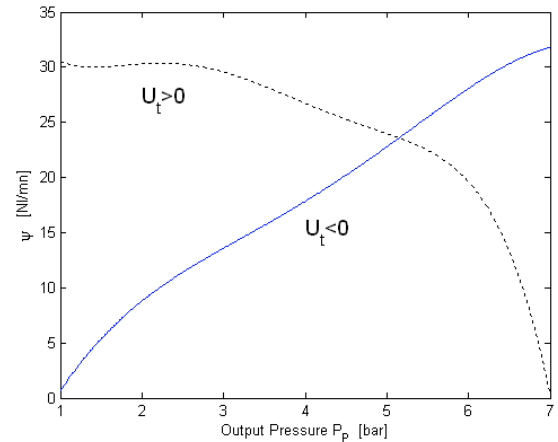

**Figure 7.** Approximation of the  $\psi(P_p, \text{sgn}(U_i))$  function.

The form of the mass flow rate shown in Figure 5. justifies the approximation by two different  $\psi$  functions, one defined for positive values of  $U_i$  and the other for negative values. The nonlinear shape of the global characteristics of the mass flow rate, as a function of the output pressure and the input control, justify the choice of the polynomial function of the form (1). The minimal degrees of the polynomials  $\varphi(P_p)$ ,  $\psi(P_p, U_i < 0)$  and  $\psi(P_p, U_i > 0)$  have the smallest absolute estimated error, equal to 4, 4 and 5 respectively.

##### IV.1. CONTROL MODEL VALIDATION

In this paragraph, it is presented a comparison of the characteristics resulting from the approximations with those resulting from the experimental measurements of the FESTO proportional valve, presented in section III.

It is reconstituted in Figure 8 (depending on the equation (1)) the evolution of the mass flow rate as a function of the electrical input control and the working pressure. This two-dimensional evolution has a shape rather near that of the static global two-dimensional characteristic of the FESTO MPYE-5-M5-010B proportional valve, as illustrated in Figure 3.

In fact it can be observed in Figure 9 that the mass flow rate reconstituted from the equation (1), gives good results comparatively to the measurements except for:

- the negative values of the input control  $U_i$  with output pressures  $P_p$  equal to 6, 6.5 and 7 bar.
- the positive values of input control  $U_i$  with a working pressure  $P_p$  near to that of the atmospheric pressure (1.25 bar and 1.5 bar).

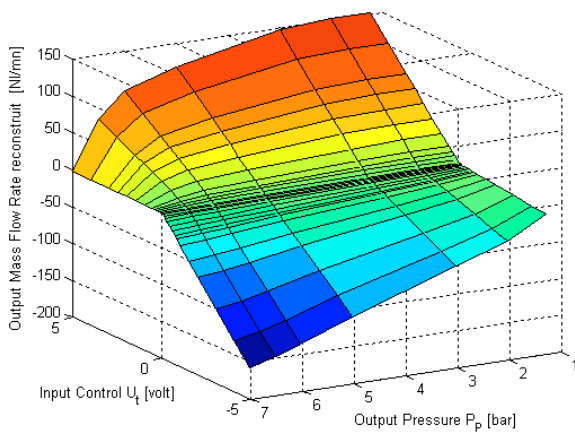

**Figure 8.** Global static characteristics reconstituted from the equation (1)

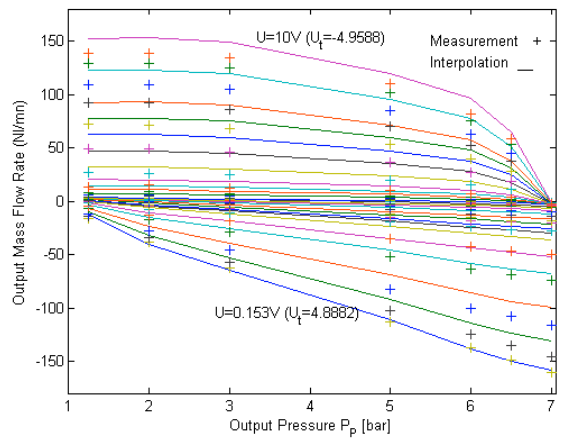

**Figure 10.** Comparison: experimental and reconstituted set of mass flow rate curves as a function of output pressure

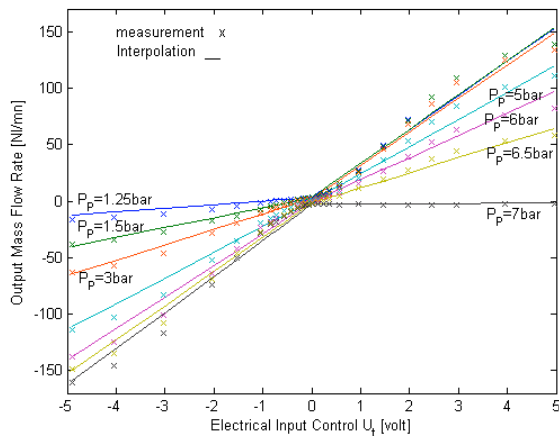

**Figure 9.** Comparison: Experimental and reconstituted set of mass flow rate curves as a function of valve input

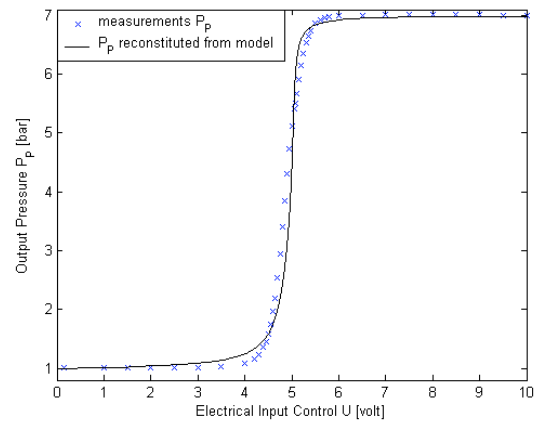

**Figure 11.** Comparison: Experimental and reconstituted pressure gain curve

Figure 10 shows also a good result except for the maximum value of the electrical input control  $U$  equal to 10 volt ( $U_t = -4.9588$ ) which corresponds to the highest working pressure  $P_p = 7$  bar. This is not troublesome for the uses under consideration, because this pressure domain has not been examined very much. It can be observed in Figure 11 that the pressure gain characteristic  $P_p$  at null mass flow rate reconstituted from equation (1) and from function  $\varphi(P_p)$  gives good results compared to the measurements. In fact the slope of the pressure gain reconstituted is larger than that measured in the experiments. In this interval the displacement of the valve spool causes the opening of one of the working orifices  $P$  or  $N$  and the closing of the other.

#### IV.2. MODELING ERROR

Two criteria were presented to validate the control model. On one hand, an absolute error of mass flow rate is obtained that is low on all the application fields of the FESTO proportional valve. On the other hand, a relative error of the mass flow rate for the greatest opening zone of a passage of fluid estimated for this component is obtained.

The absolute errors of the mass flow rate generated by the control model given by the equation (1) are weak (between  $-15$  Nl/mn and  $+15$  Nl/mn) as shown in Figure 12. They are maximal at the edges of the pressure field  $P_p$ .

The relative errors of mass flow rates generated by the approximations for the values of electrical input control  $U_t$  outside the interval  $[-1, +1]$ , are between  $-10\%$  and  $+15\%$  (Figure 13)



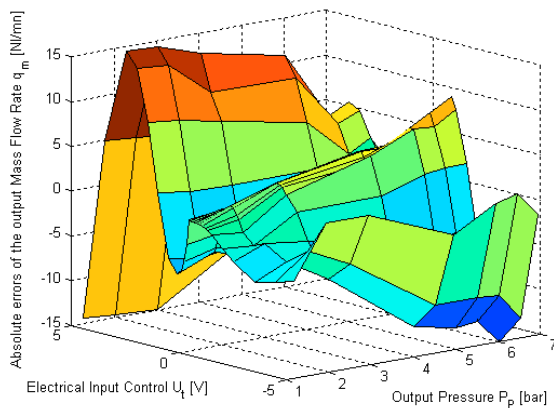

Figure 12. Mass flow rate absolute errors

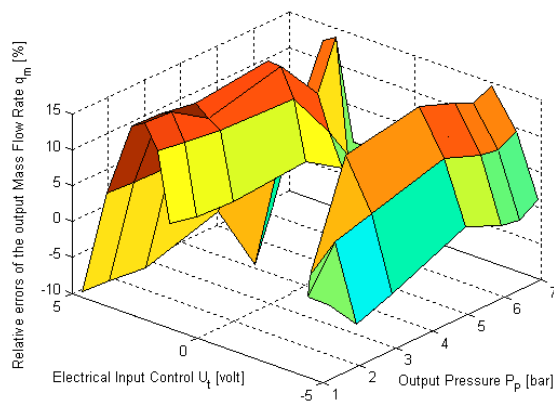

Figure 13. Mass flow rate relative errors

These approximations knowledge will be useful to synthesize nonlinear robust control law [9].

## V. CONCLUSION

In this paper an analytical model of a MPYE-5-M5-010B proportional 5-way valve from the FESTO company has been presented. A mathematical model has been obtained after realizing a global characterization of the static flow stage of this servo flow control valve. The experimental measurements carried out for a characterization in three-dimensions (mass flow rate, output pressure and electrical input control), can be used as a simulation model. The good results obtained show that the characterization protocol of a Servo-distributor carried out previously [7] can be used for another pneumatic modulator. The characteristics presented in Figure 3 can consider FESTO servo-pneumatic valve is

suitable to carry out the functions of the childbirth simulator BirthSIM.

The analytical model of the FESTO proportional valve was validated by reconstituting the global two-dimensional characterizations and the pressure gain curve at null mass flow rate. The weak errors of the mass flow rate enabled the control model to be validated. A control synthesis would enable the simulator BirthSIM to be automated. In fact the generation of input trajectories for our system is an important problem to resolve in order to translate the medical conditions into an automation problem. Later it will be necessary to realize different procedures and to synthesis robust controls in order to minimize tracking errors in a highly non-linear field.

## REFERENCES

- [1] KAASA, G. -O., CHAPPLE, P. -J., LIE, B., *Modeling of an electro-pneumatic cylinder actuator for nonlinear and adaptive control, with application to clutch actuation in heavy-duty trucks*, In the 3rd International Ph.D. Symposium on Fluid Power, Terrassa, Spain, 30th June- 2nd July, 2004, p 255-273.
- [2] BRUN, X., BELGHARBI, M., SESMAT, S., THOMASSET, D., SCAVARDA, S., *Control of an electropneumatic actuator, comparison between some linear and nonlinear control laws*, Journal of Systems and Control Engineering, 1999, Vol. 213, N°15, p 387-406.
- [3] FERNANDEZ-JIMENEZ, A., PEREZ GARCIA, J., *Compressible bench flow adaptations to the experimental characterization of pneumatic components. Application to the determination of flow-rate characteristics of a MPYE-5-3/8-010-B proportional valve*, In the 3rd International Ph.D. Symposium on Fluid Power, Terrassa, Spain, 30th June- 2nd July, 2004, p 139-148.
- [4] SILVEIRA R., DUPUIS O., PHAM M.T., DITTMAR A., REDARCE T., BETEMPS M. *Design of a Mechanical birth simulator*. World Congress on Men's Health Medicine - WCMHM'04. 5-8/04/2004, Paris, France, 2004.
- [5] SILVEIRA R., DUPUIS O., PHAM M.T., REDARCE T., BETEMPS M. *A new mechanical birth simulator*. IEEE/RSJ International Conference on Intelligent Robots and Systems - IROS'04, 28/09-2/11 2004, Sendai, Japan, 2004, pp 3948-3953.
- [6] DUPUIS, O., DITTMAR, A., DELHOMME, G., REDARCE, T., BETEMPS, M., SILVEIRA, R., *Simulateur fonctionnel et anatomique d'accouchement*. French patent number: 0309569, August 01, 2003.
- [7] SESMAT, S., SCAVARDA, S. *Static characteristics of a three-way servovalve*, In: 12th Aachen Conference on Fluid Power Technology, Aachen, Allemagne, March 12-13, 1996, p 643-652.
- [8] BELGHARBI, M., THOMASSET, D., SCAVARDA, S., SESMAT, S., *Analytical model of the flow stage of a pneumatic servo-distributor for simulation and nonlinear control*, in the Sixth Scandinavian International Conference on Fluid Power, SICFP'99, Tampere, Finland, May 26-28, 1999, p 847-860.
- [9] SMAOUI, M., BRUN, X., THOMASSET, D., *A combined first and second order sliding mode approach for position and pressure control of an electropneumatic system*, American Control Conference, ACC'05, Portland, Oregon, USA, June 8-10, 2005