



HAL
open science

Pulsating combustion of ethylene in micro-channels with a controlled temperature gradient

Annalisa Di Stazio, Christian Chauveau, Guillaume Dayma, Philippe Dagaut

► **To cite this version:**

Annalisa Di Stazio, Christian Chauveau, Guillaume Dayma, Philippe Dagaut. Pulsating combustion of ethylene in micro-channels with a controlled temperature gradient. 36th International Symposium on Combustion, Jul 2016, Seoul, South Korea. 10.13140/RG.2.2.14743.42407 . hal-02063471

HAL Id: hal-02063471

<https://hal.science/hal-02063471v1>

Submitted on 11 Mar 2019

HAL is a multi-disciplinary open access archive for the deposit and dissemination of scientific research documents, whether they are published or not. The documents may come from teaching and research institutions in France or abroad, or from public or private research centers.

L'archive ouverte pluridisciplinaire **HAL**, est destinée au dépôt et à la diffusion de documents scientifiques de niveau recherche, publiés ou non, émanant des établissements d'enseignement et de recherche français ou étrangers, des laboratoires publics ou privés.

Pulsating combustion of ethylene in micro-channels with a controlled temperature gradient

A. Di Stazio, C. Chauveau*, G. Dayma, P. Dagaut
 Centre National de la Recherche Scientifique
 Institut de Combustion Aérothermique Réactivité et Environnement
 45071 Orléans cedex 2, France
 *christian.chauveau@cnsr-orleans.fr

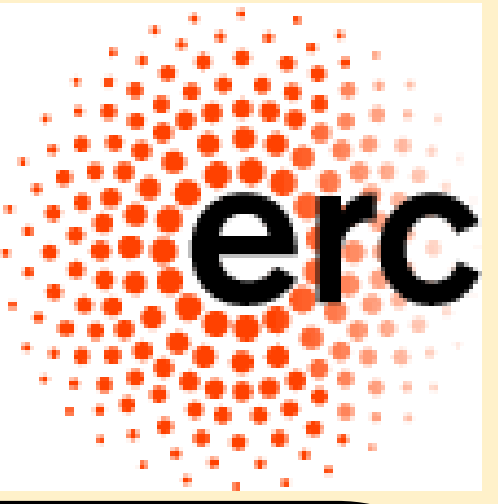

The aim of our study

- Growing need to improve knowledge in the field of **small-scale combustion** for engineering applications (MEMS [1]).
- The new system can afford the study of the **combustion characteristic of different fuels in very-lean conditions** at micro-scale.

The new device

A cylindrical quartz tube was set between three heat sources and heated by hydrogen/oxygen flames. The temperature profile along the outer side of the reactor was measured by a FLIR A655sc infrared camera with an emissivity correction factor. A spectroscopy EMCCD camera (ProEM 1600) with a CH* band-pass filter was used to detect the flame positions. C₂H₄/air mixtures were supplied in a 1 mm internal diameter reactor at atmospheric pressure.

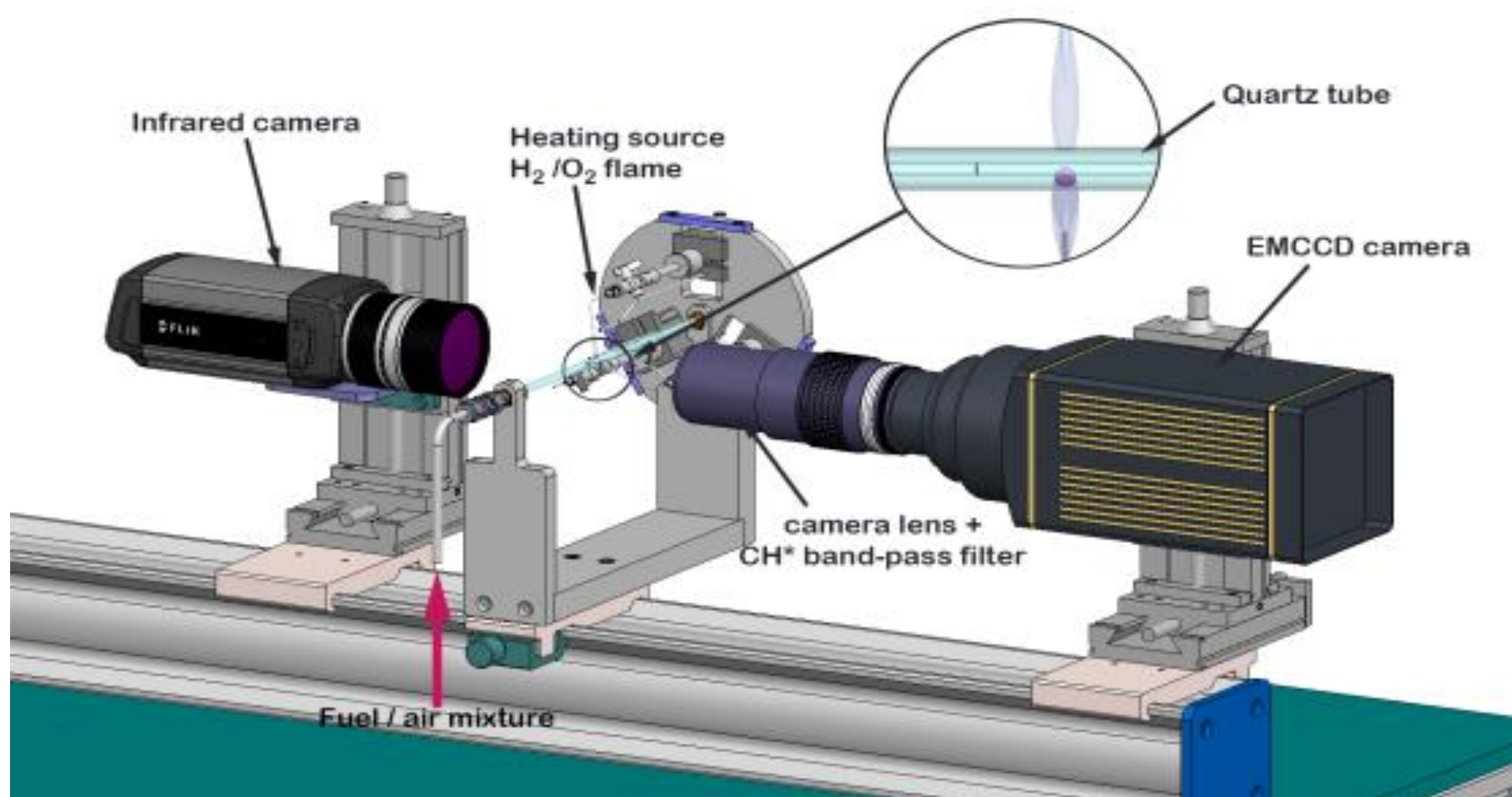
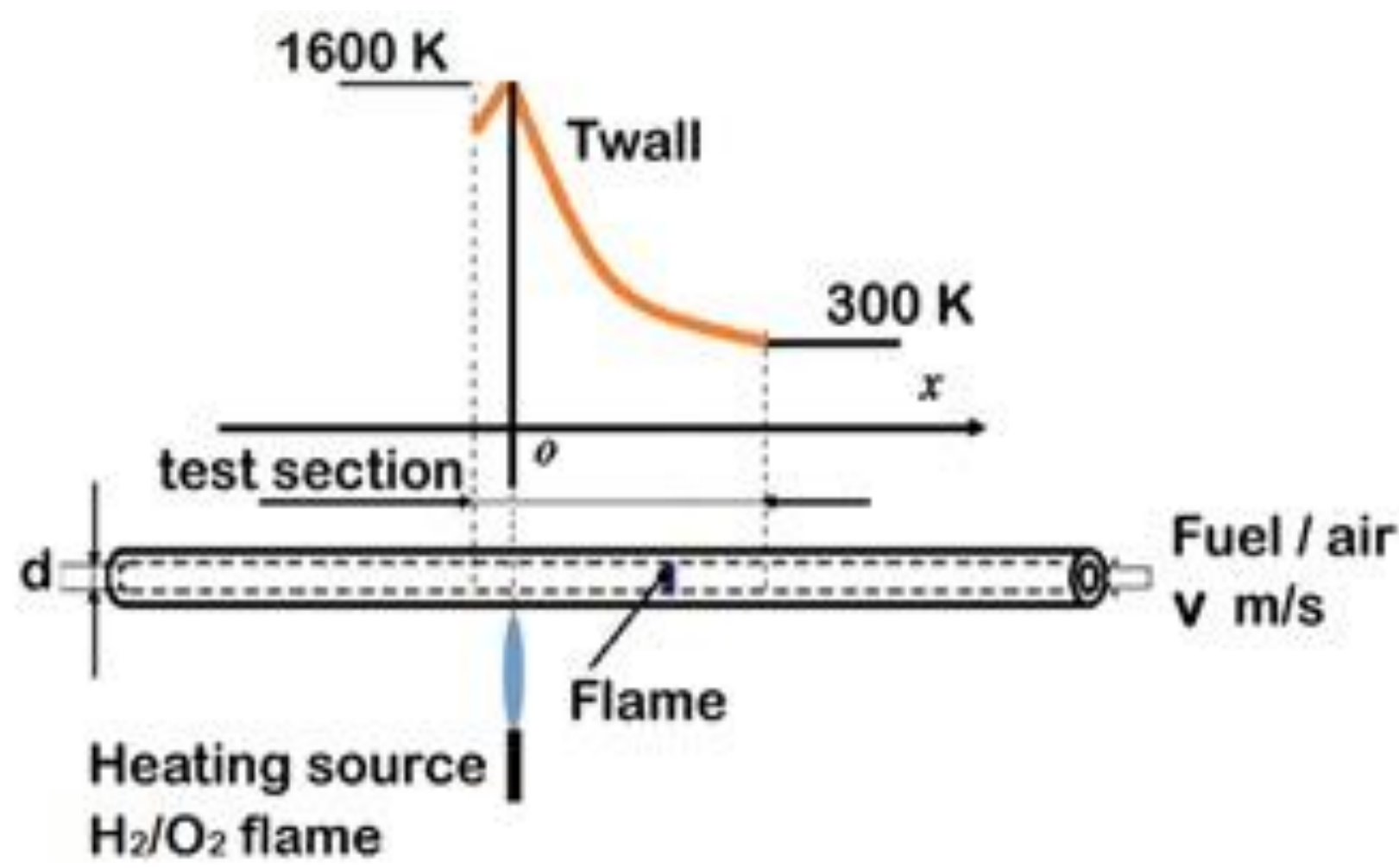

Flame Visualization

Stable flames (a) have flat profiles due to the narrow reactor section.
Unstable flames (b), named **FREI** (*flames with repetitive extinction and ignition* [2]) are present in the middle-range of the flow velocity.
 The ignition occurs at the downstream and the extinction at upstream.
Weak flames (c), typical of mild combustion [3], were observed for very low velocities.
Oscillating weak flames (d) and **Oscillating FREI** (e), fluctuating with very small amplitude and high frequency, were observed in **very-lean** and **lean conditions** [4].

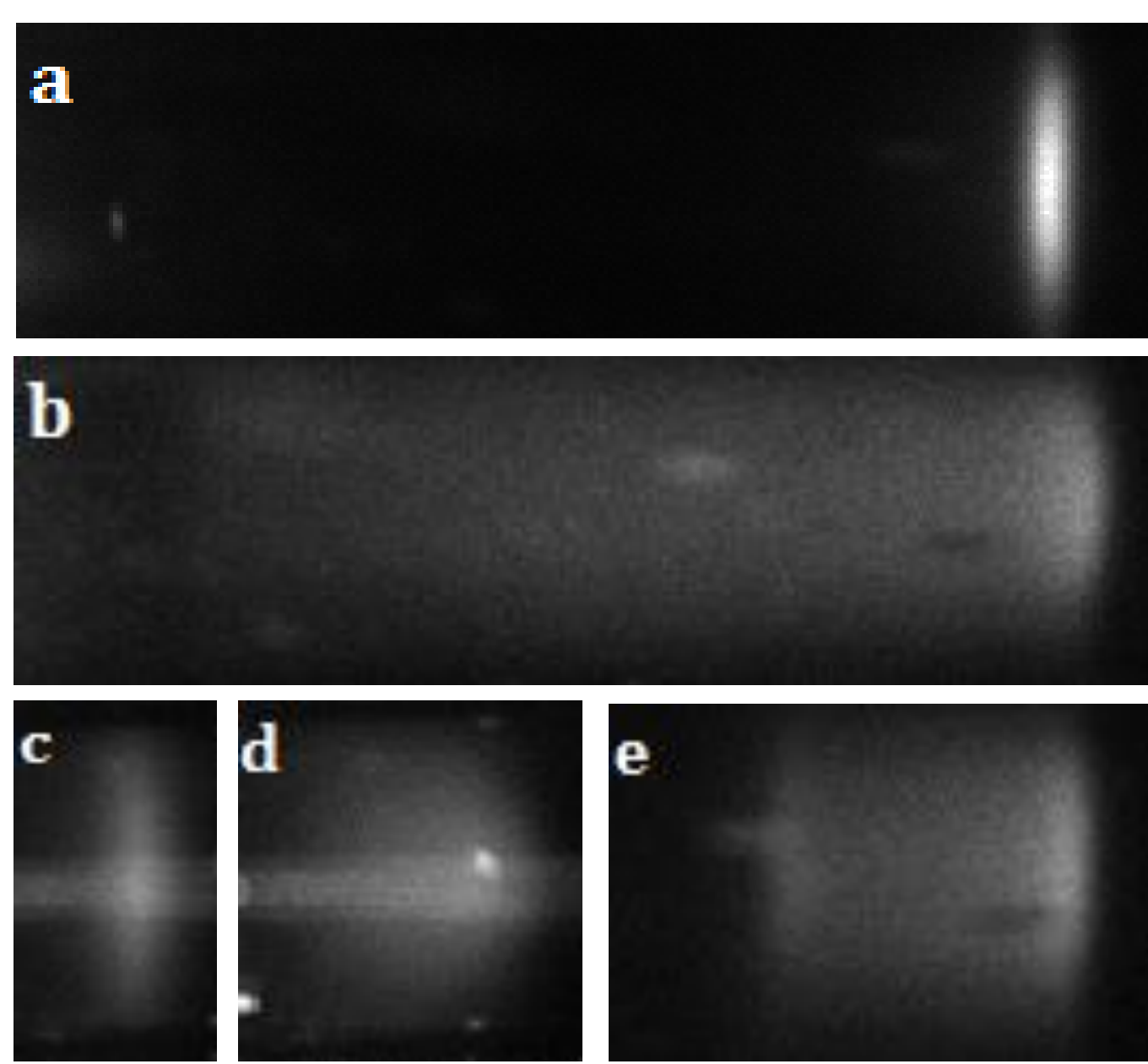

Results: very-lean conditions ($\phi = 0,3$)

Only weak flames and oscillating weak flames were observed.

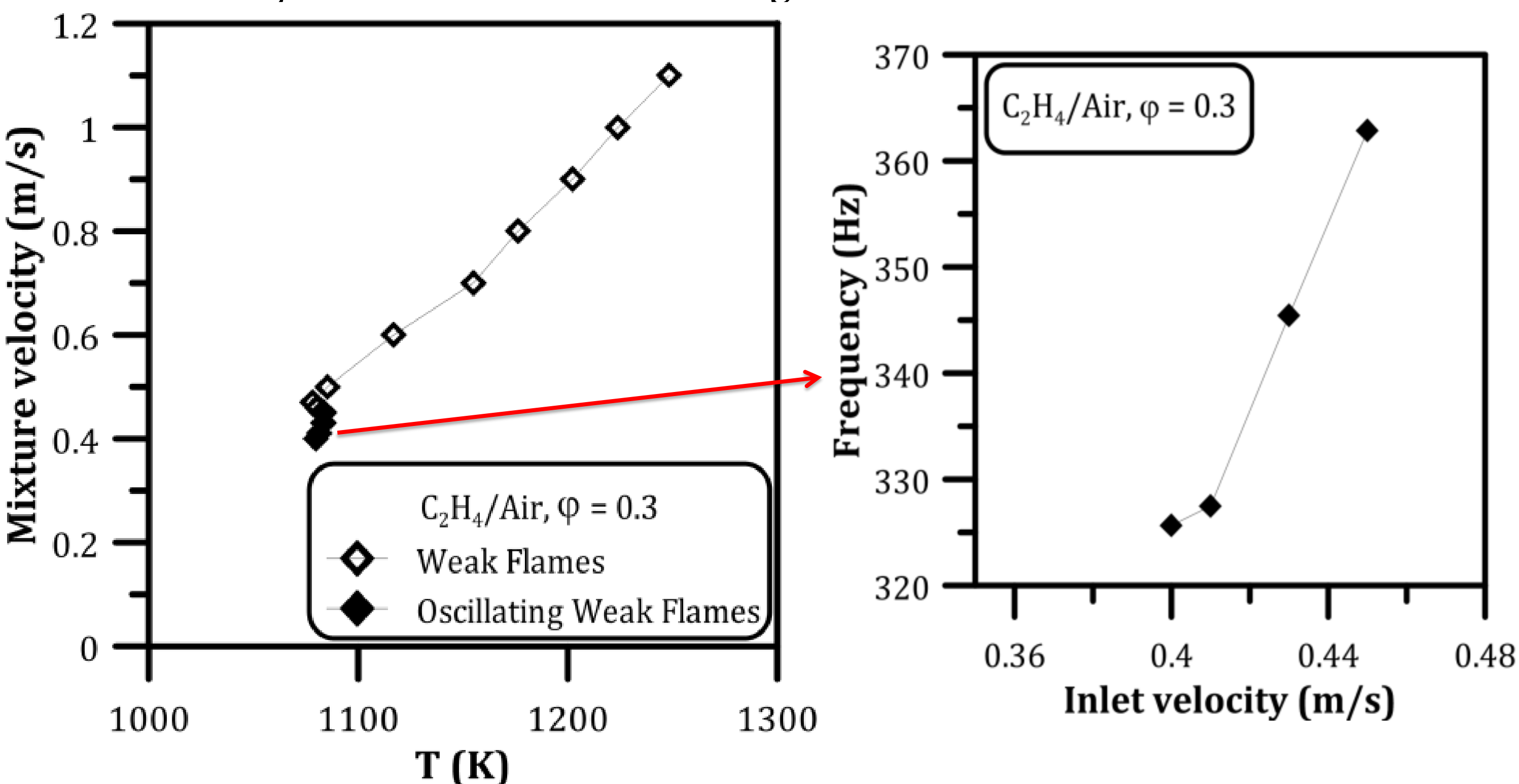

References

- [1] A.C. Fernandez-Pello, Proc. Combust. Inst., 29 (1) (2002) 883-899.
- [2] Y. Ju, K. Maruta, Prog. Energy Combust. Sci., 37 (6) (2011) 669-715.
- [3] A. Cavaliere, M. de Joannon, Prog. Energy Combust. Sci., 30 (4) (2004) 329-366.
- [4] T.L. Jackson, J. Buckmaster, Z. Lu, D.C. Kyritsis, L. Massa, Proc. Combust. Inst., 31 (1) (2007) 955-962.
- [5] A. Fan, S.S. Minaev, E.V. Sereshchenko, Y. Tsuboi, H. Oshibe, H. Nakamura, K. Maruta, Combustion, Explosion, and Shock Waves, 45 (3) (2009) 245-250.
- [6] S. Minaev, E.V. Sereshchenko, R.V. Fursenko, A. Fan, K. Maruta, Combustion, Explosion, and Shock Waves, 45 (2) (2009) 119-125.

Equivalence ratio effect and FREI dynamics

Flame position defined at the wall temperature as a function of the mixture flow velocity at various equivalence ratios: 0.3 (grey), 0.4 (blue), 0.7 (orange), 0.9 (red), 1 (black), 1.1 (green), 1.3 (purple), 1.5 (pink).

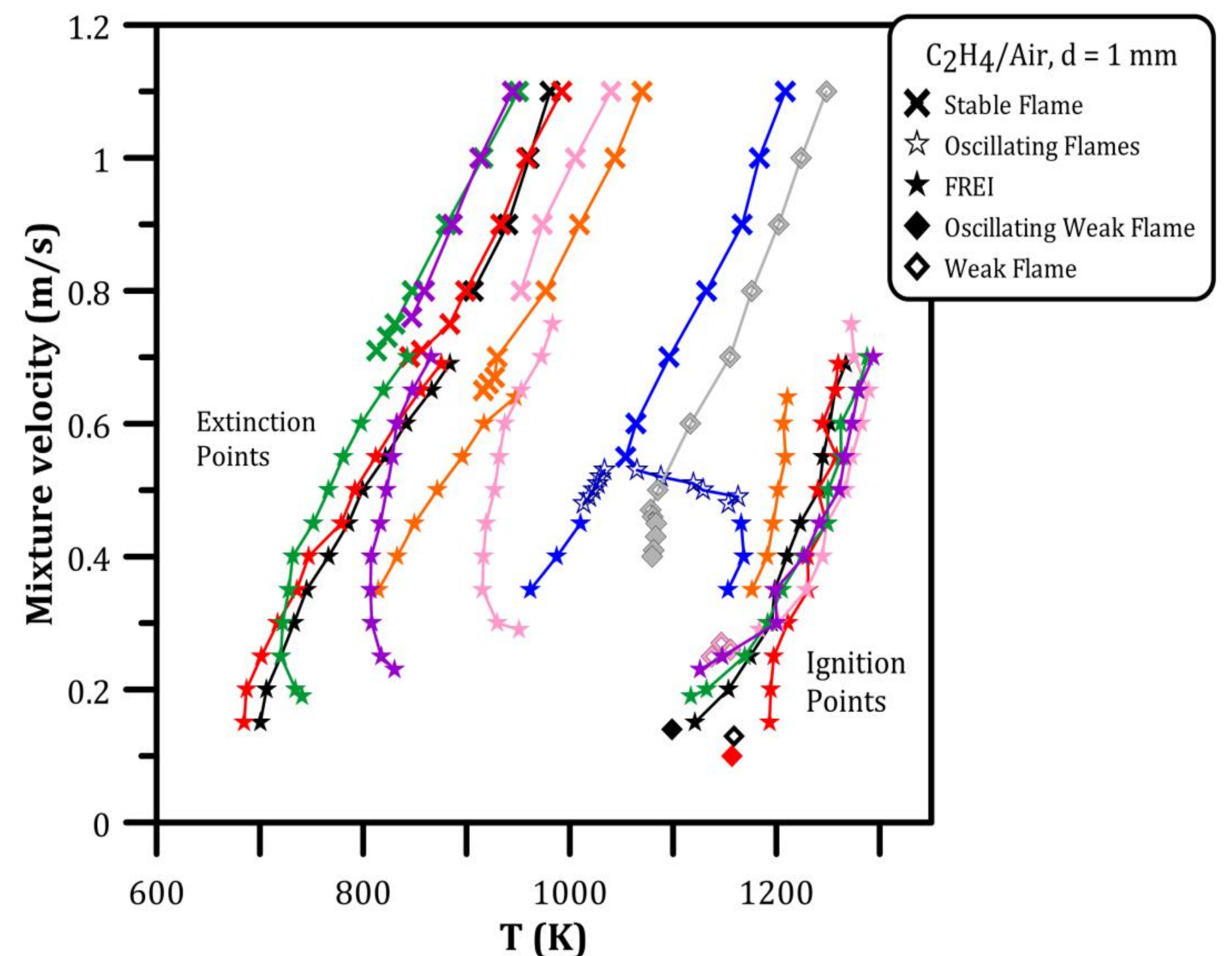

Using the Fourier function on the spectral cross-section of the CH signal, it is possible to determine the **flame frequencies**. The results obtained with CH₄/Air in a 1 mm internal diameter reactor are also reported.

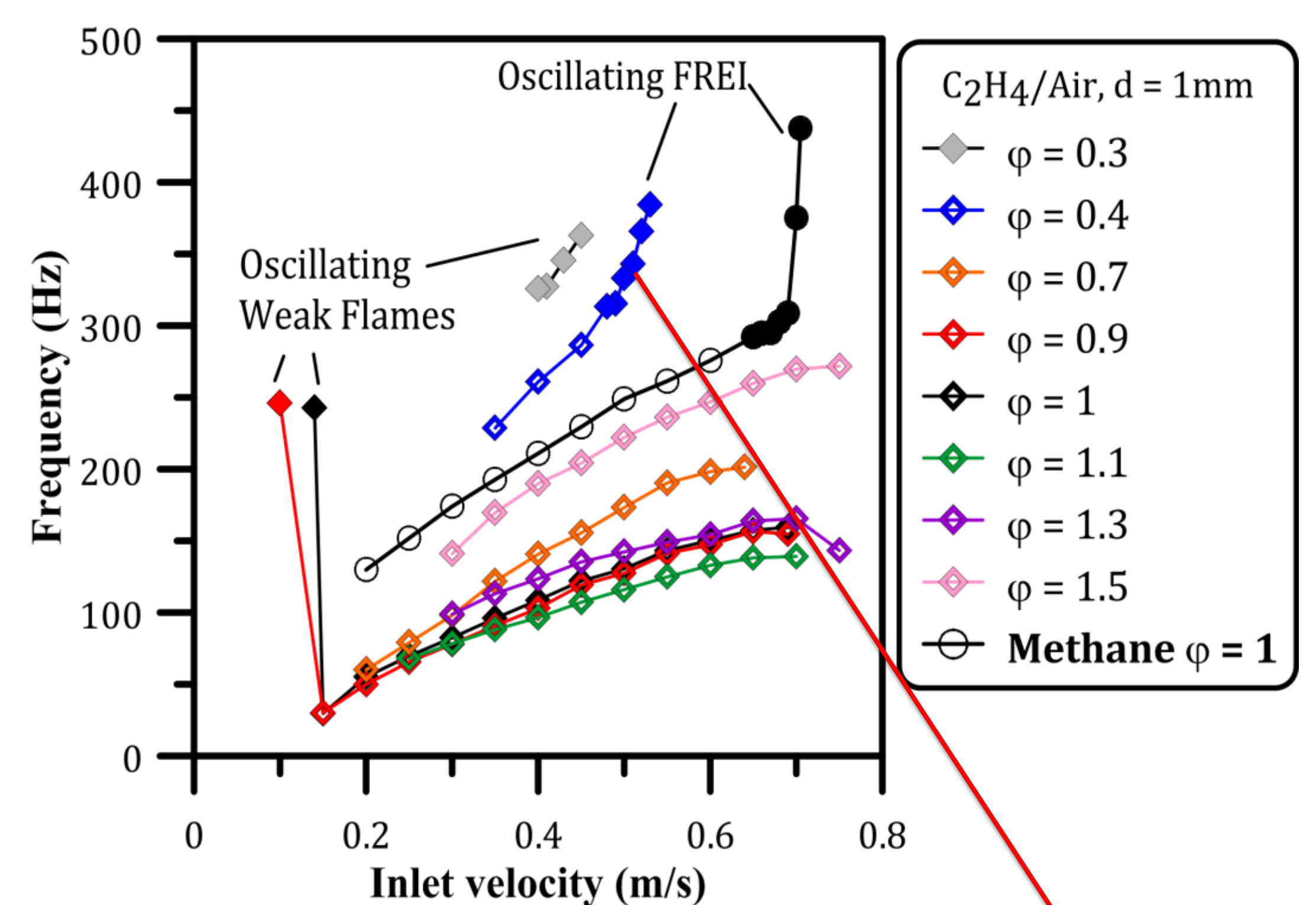

Oscillating FREI were observed in the transition region between stable flames and FREI at an equivalence ratio of 0.4. These flames oscillate at high frequency but do not extinguish (the CH* signal does not go to zero). The oscillation amplitude increases when decreasing the inlet velocity until getting a typical FREI. The mathematical model proposed by Jackson et al. [4] was able to predict these instabilities that are due to the heat losses through the tube wall.

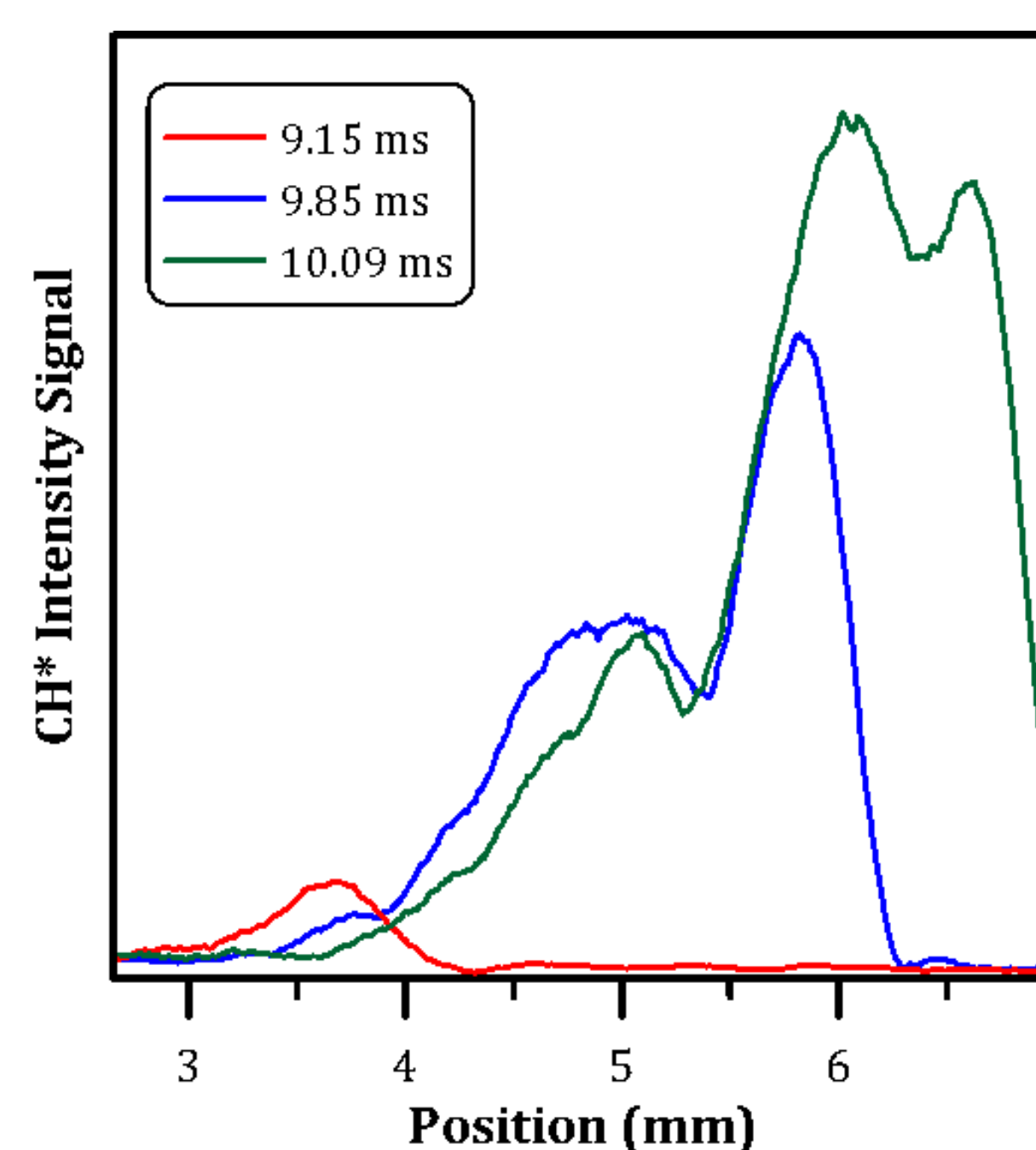
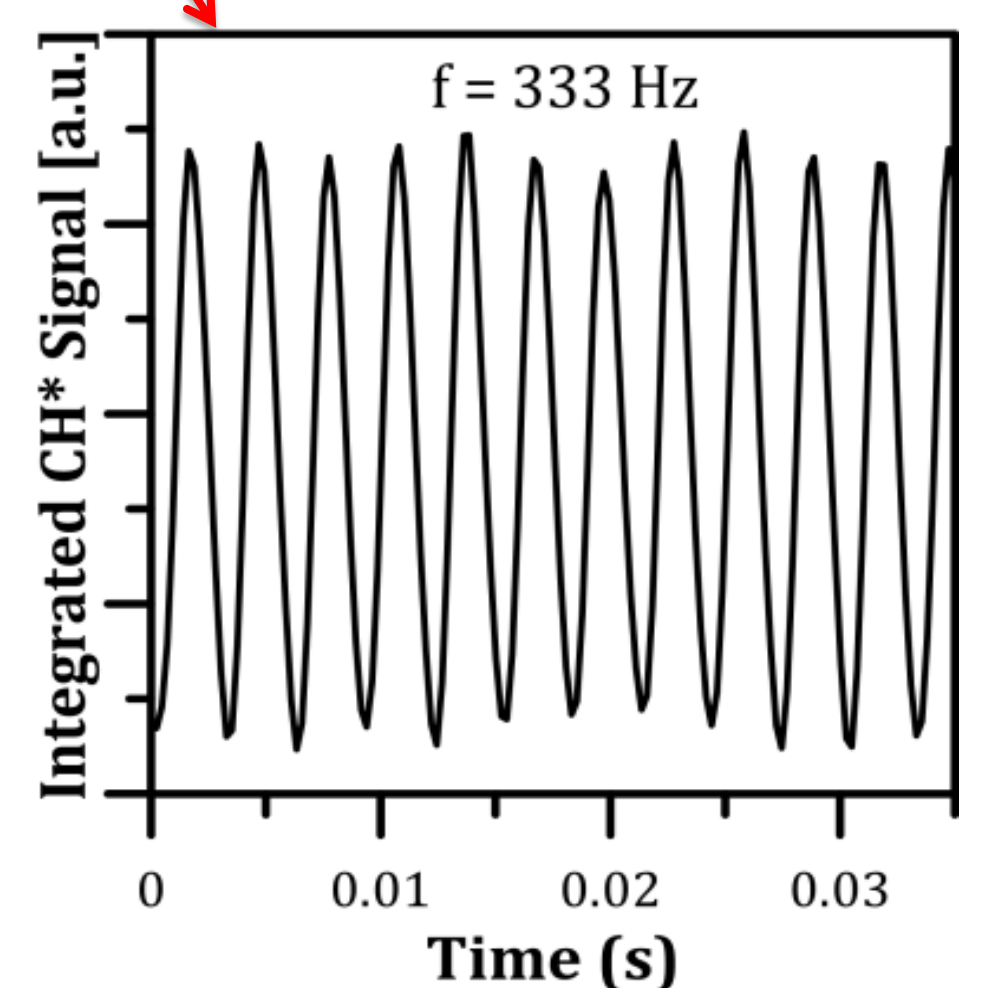

The presence of **multiple CH* peaks** was detected during FREI propagation at high equivalence ratio ($\phi \geq 1$): this is probably due to the combustion of remaining unburned species behind the main flame front. Previous studies [5, 6] confirms the existence of **splitting flames** for methane/air mixtures.

Acknowledgements

The research leading to these results has received funding from the European Research Council under the European Community's Seventh Framework Programme (FP7/2007-2013) / ERC grant agreement n° 291049 – 2G-CSafe and from the Agence Nationale de la Recherche (ANR-12-VPTT-0008).