



HAL
open science

Gas microsensor technology

Philippe Menini

► **To cite this version:**

Philippe Menini. Gas microsensor technology. R. Lalauze. Chemical Sensors and Biosensors, Wiley book, 2012, 978-1-84821-403-3. hal-02048941

HAL Id: hal-02048941

<https://hal.science/hal-02048941v1>

Submitted on 26 Feb 2019

HAL is a multi-disciplinary open access archive for the deposit and dissemination of scientific research documents, whether they are published or not. The documents may come from teaching and research institutions in France or abroad, or from public or private research centers.

L'archive ouverte pluridisciplinaire **HAL**, est destinée au dépôt et à la diffusion de documents scientifiques de niveau recherche, publiés ou non, émanant des établissements d'enseignement et de recherche français ou étrangers, des laboratoires publics ou privés.

Chapter 8: Gas microsensor technology

Philippe MENINI

Introduction

In both the literature and industry, there are various examples of gas detection devices which use electrochemical sensors, resistive metal oxide based sensors, catalytic or even piezoelectric sensors.

The growing interest in these sensors, both in industry and research is due to several reasons. Among others, we can cite low production costs aided by the development of microelectronic technologies. This allows us to reduce the size of components and therefore produce a large number of sensors on one silicon wafer. As such, with the emergence of Microsystems (as of the beginning of the 1980s), we are seeing an ever increasing development of miniature, portable and “intelligent” devices integrating sensor(s), its supply, processing electronics and other elements. These are therefore termed as integrated electronic noses.

Producing these devices involves standard microelectronics technologies as well as new techniques for designing and integrating new materials which are often nanostructures or even new micro-production or assembly methods. This allows the

industry to respond to the needs of the market such as low production costs, the lowest possible energy consumption, good stability, reproducibility, reliability and increased portability. Even in 2005, 70% of gas detectors were portable with a constant progression of this rate year on year (76% today).

Among the sensors developed so far, semiconductive gas sensors today respond to these needs best with moderate production costs (which decrease as the number being produced increases). They are therefore not only well adapted to microelectronic techniques but also integrate a large number of materials such as metal oxides, semiconductive polymers and other components. The first metal oxide based gas sensors to be marketed were developed by Seiyama and Taguchi in the 1960s using ZnO and SnO₂ as sensitive materials for detecting liquid petroleum gases (LPG). Since then, extensive research has been carried out to improve performance which still remains to be perfected in terms of stability, reproducibility and particularly selectivity.

In the middle of the 2000s, the “Grand research challenges” as set out by the MNT Gas Sensor Forum (December 2006) included the following:

- COV characterizing inside and vehicle cabin air quality.
- Identifying gases from patients in medical analysis (measuring abnormal variations in gaseous markers of disease).
- **Improving selectivity and stability for semiconductor gas sensors**
- A combinatorial methodology for optimizing sensing materials.
- Integrated MEMS using sensor networks (combination of sensing optima).

This chapter will be split into two main parts:

- Technological development of metal oxide sensors
- Developing a new generation of wireless communicative gas sensors whilst responding to these current main challenges.

2. Metal oxide gas sensor technology

2.1. Overview of how gas sensors function

In semiconductor gas sensors, chemical information is sent to the material's electronic structure and its surfaces as measurable electrical characteristics such as changes in conductivity. As measurable, interactions, mostly consisting of chemisorption, they are mainly oxidation-reduction reactions which occur during the exchange of electrons between the gas and sensitive material.

The main factors affecting the detection of gas spaces on a 'sensitive' layer are surface temperature, concentrations of O₂ and H₂O (relative to the number of molecules in contact with the surface) and the flux of gas on the surface (relating to the number of gas/ surface collisions). The existence of an oxygenized space on the surface of the sensory layer strongly depends on the energy provided i.e. the sensor's operating temperature and its variations. **In other words, sensitivity to gas depends on the surface state and the sensitive layer's temperature.**

Finally, the material's morphology plays an important role in global transduction. It defines the specific surface and transport properties inside the material. Sensitivity and selectivity to gas depend on the sensitive material's structure, whether compact, porous or nanostructured.

2.2. Existing structures

As we have seen, in order to optimize adsorption phenomena and exchanges of electrons between the gas and the sensitive material (metal oxide), it is necessary to heat the surface to high temperatures (between 300 and 500°C). Metal oxide based gas sensors are therefore composed of:

- A sensitive layer composed of the part which interacts with the gas environment.
- Electrodes for electric measures of this sensitive layer.
- A heating element which brings the sensitive layer to temperature. This part must be well isolated electrically from the measuring electrodes.

A diagram showing how the sensor functions is shown in figure 1. Only four technological elements are required: the three parts described plus the insulating layer.

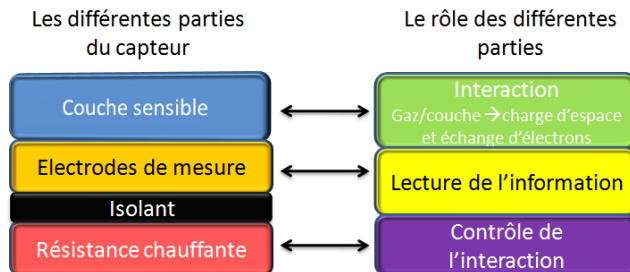

Figure 1. Functional diagram of a semiconductor gas sensor

This schema demonstrates the simplicity of these systems and therefore their 'cost based' characteristic.

It should be noted that the collection of thermal resistance/ measuring electrodes is termed a 'microhotplate' in the literature.

2.2.1. Electrodes

Electrodes create an electrical contact with the sensitive layer to measure its conductivity (or resistance). They enable the material's charges to be conducted towards the circuit receiving the signal. Electrodes are said to be optimal if they establish good ohmic contact with the sensitive layer and enable the maximum transfer of the material's charges towards the circuit. The parameters involved in their design are their geometry and the materials used given that they must withstand high temperatures.

A. Material for electrodes

The materials sought must be good conductors and remain stable over time, particularly with very high temperatures. The optimization of contact between the electrode and sensitive layer in terms of response (resistance, capacity etc.) requires the use of pure metal contacts. The choice is normally one between metals such as aluminum (simple), gold, (Au noble), platinum (Pt, noble), tungsten (W, refractory), tantalum (Ta, noble) or Chrome (Cr, noble). These electrodes can be a superposition of these materials to obtain the desired characteristics.

It has been shown that platinum electrodes are best adapted for a gas sensor with an SnO₂ layer, which is the most commonly used material today. Generally associated with a 'bonding layer' in titanium, platinum has highly stable characteristics in various temperatures and temporally (it only oxidizes as of 650°C). This also has a catalyzing effect on certain gases such as CO. However, when detecting oxidizing gases, it has been shown that adding a layer of gold improves performance.

B. Electrodes' geometry

The electrodes' geometry determines the lines of current (the possible paths for carriers) in the material. These conception parameters are the surface, form, inter-electrode spacing and their positions. Based on the existing studies on numerical simulation into the form and position of electrodes on the response of a gas sensor, it is evident that the electrodes' geometry has an influence on the sensor's sensitivity and selectivity. A poor choice of electrodes can result in a poorly performing sensor even if the sensitive material is well adapted. In addition, the greater the surface area between the electrode/ sensitive layer, the weaker the measured resistance (which is interesting for high resistive materials).

There are several adapted geometries for two electrode measures (measuring via two parallel, perpendicular points with interdigitized contacts etc.), four point measures, transmission lines or even micro contact. In the literature there are more complex multi-electrode systems of different sizes, forms and spacings. It is therefore possible to add further information to the previously examined configurations. A multiple electrode sensor is an equivalent system to a multi-sensor.

C. Heating elements

The heating element is of great importance for sensors. It allows the sensitive layer to reach very high temperatures (500°C, 600°C) which, depending on the type of layer and gas being detected, enables optimal reaction between the gas and the surface. Again, the choice of material is essential in withstanding these temperatures without being damaged.

Materials employed

The main factors affecting resistance to heating are firstly the possibility of increasing to temperatures which are sufficiently high to adsorb molecules as well as desorption to render the sensor reversible. The higher the temperature range, the more the number of adsorbed, desorbed spaces is important. The maximum heating temperature depends strongly on the material used.

Commercial sensors mostly have heating resistors made of polysilicon or platinum. Polysilicon is easy to integrate with a resistance value which is adjustable by doping but its properties drift less over time. Its resistance value changes gradually and the temperature provided by the heating element changes over time. In order to enable it to function in identical temperature conditions, it is necessary to compensate for these faults using regular calibration or even power regulation which accelerates aging of the heating resistor in both cases. As such, polysilicon sensors have an operating limit of 450°C. The use of metals such as platinum (or Mo, Ti, Cr,

TiN etc.) allows us to reach much higher temperatures (600°C or more) and provides better stability of performances (less drift overtime).

Geometry employed

Constance of temperature is very important. It is preferable that the sensitive layer is heated uniformly. Hot points should be avoided in order to standardize surface reactions. Significant discrepancies in temperature can result in very different spaces over the surface and, furthermore, increase the possibility of different reactions. As such, a strong temperature gradient on the sensitive layer can lead to instabilities, even uncontrolled drifts over time (partial oxidizations of the material). Normally the forms used are rectangular tablets of polysilicon which create good uniformity in temperature or a platinum coil. In practice, these heating structures can be highly varied:

- Heating resistor covered in a sensitive material (1st Figaro sensors)
- Metal resistance on an insulating substrate (aluminum, glass etc.)
- Integrated resistance on a closed membrane
- Integrated resistance on a suspended platform
- Platform on a suspended platform

D. Sensitive layers

In the same way that there are different types of material for detecting gas (polymers, elementary semiconductor, organic etc.), metal oxides are currently the subject of attention because they are often an ionic material with a high degree of gas sensitivity. Thanks to new synthesis technologies, it is possible to gain good geometric and structural control (nanostructure) with high porosity which enables a larger surface area for exchange with the gas.

Metal oxides can be found in the form of powders, thin or thick films, grains and nanoparticles etc.

Two approaches are used for synthesis methods:

- ‘Top-down’ physical methods (mechanical, electrical or thermal erosion etc.) are applied to a large solid to divide it.
- ‘Bottom-up’ methods. In contrast this method involves condensing the atoms, ions or molecules (in gas or liquid).

The metal oxide can be synthesized and then installed into the sensor or produced during (chemical) bonding. The main synthesis methods are summarized in figure 1.

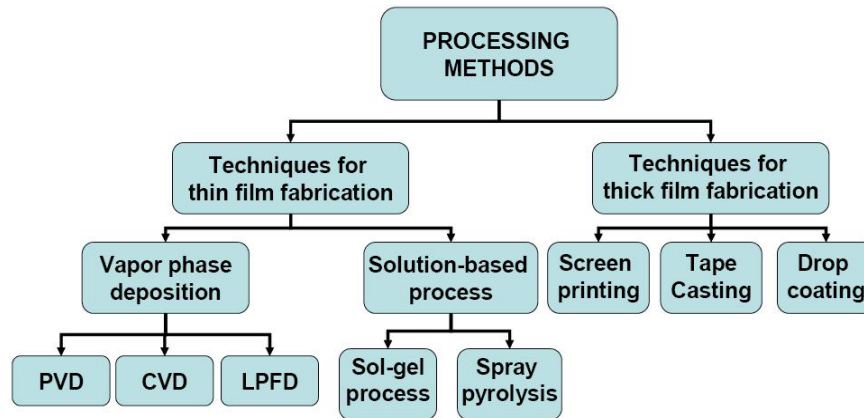

- **Figure 2.** The main techniques used to produce thick or thin layers.

The different deposition techniques (linked to synthesis methods) are as follows:

- Collage (slurry deposition)
- Screen-printing
- Drop deposition
- Dip coating
- Spray deposition
- Chemical Vapor Deposition (CVD)
- Thermal CVD
- Plasma activated CVD
- Laser induced CVD
- Electroless plating
- Physical Vapor Deposition (PVD)
- Sputtering
- Evaporation

The choice of synthesis method and deposition technique defines the material's morphology and its detection properties.

For a number of years 'bottom-up' methods have been the most commonly used in research, notably for creating nanostructured materials (nanoparticles, nanorods and nanowires) to obtain sensitive layers with an effective strong surface.

2.3. Different technological approaches

2.3.1. Heating platforms on a solid substrate

In the literature there are a number of platforms based on a solid substrate made from aluminum, glass, sapphire, gallium arsenide (GaAs) and, more recently, polymers.

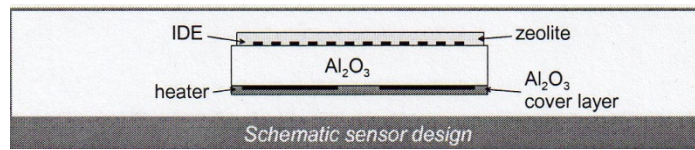

• **Figure 3.** Illustration of a heating platform with a aluminum solid substrate

The heat resistor can either be located on the back of the substrate, placed on the front or ‘embedded’ as shown by figure 4 which represents a polyimide structure with platinum plating. This ‘subtle’ structure means it can reach temperatures of 325°C for a consumption power of 130mW.

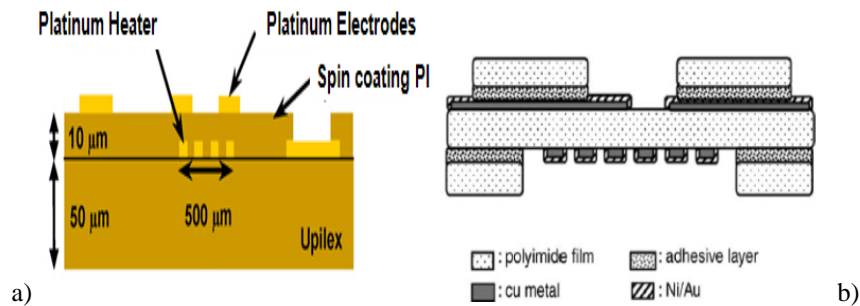

• **Figure 4.** Platform on a substrate: a) plating on the face of a substrate; b) on a thinned substrate

Fig. 4b) is an example of a platform on a thin layer with a heating resistor at the back. However, this system is only designed to function at low temperatures (around 100°C with 80mW).

The choice of materials is clearly an essential factor when building the heating platform. Even if the maximum temperature reached by previous structures in

polymers is decent (350°C), it is still not high enough for applications such as desorption of some molecules found on the surface of the sensitive layer.

Today there are devices being marketed based on the structure of a solid substrate on ceramic (aluminum). Examples of this include the SP series developed by FIS Inc. These platforms reach 400°C (typical functioning temperature) for a consumption power of around 400mW. This consumption can be improved by creating a multilayer material with specific materials. This is notably the case for a carbon monoxide sensor (CO) recently developed by Figaro which was composed of an aluminum substrate, a heater (made from RuO₂) thermally insulated by glass. The power consumed was therefore reduced by factor two in continuous mode.

2.3.2. Heating platforms on a membrane

Constructed using the same platform as previous platforms, a platform on a membrane is principally designed to reduce the power consumed whilst minimizing thermal inertia. This is aided by advances in microelectronics which have enabled the miniaturization and integration of these devices. It is based on silicon technology and generally contains a silicon substrate which is placed under a membrane, heating element and electrical connections. In this section we will examine the different existing structures followed by an overview of the different production techniques as well as the materials used.

There are two main types of architecture which can be distinguished:

- ❖ **Suspended structures** are said to be compatible with CMOS technology because the structure is open on the side in front of the substrate. The sensor's active zone is therefore reduced to a small surface suspended on the substrate by suspension arms as shown in fig. 5. From a purely thermal perspective, it is better for the structure to be closed because this creates better insulation (less thermal loss by conduction towards the substrate) and therefore minimized energy consumption. Another advantage of this platform is due to its production (speed and cost). Fabrication procedures take place on the front side with masking alignments taking place on the side opposite the closed platforms, thus requiring a double-side alignment.

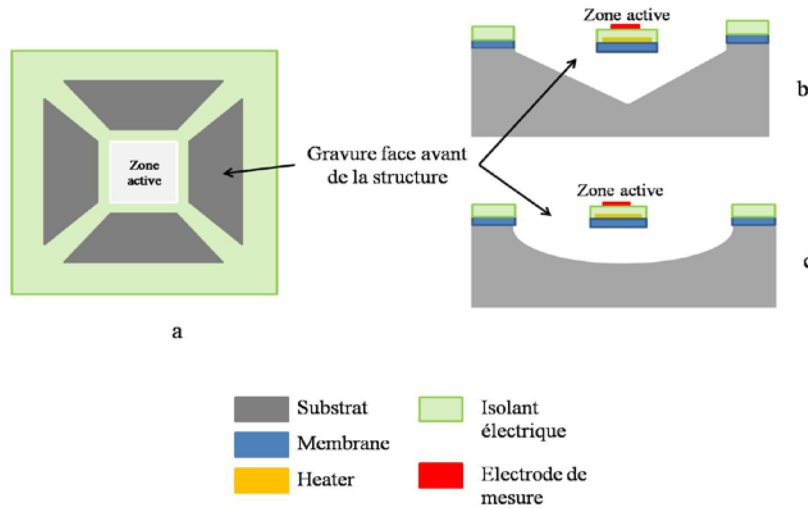

• **Figure 5.** *Suspended platform a) from in front; b and c two examples of etchings*

Table 1 which follows lists the main devices created in research laboratories (none of these structures have been marketed to date). As we can see, it is possible to reach normal functioning temperatures with relatively low energy consumption depending on the material and geometry used.

Despite highly interesting thermal performance, the device's thermal stability at high temperatures can be confusing if working at variable temperatures (pulsing mode) and we integrate highly constrained materials (sensitive layer) with more diverse layers integrating the platform (membrane, heater element and electrical connections). The main limitation of all these structures is their mechanical fragility linked to deformations in temperature. These deformations can be significant and, in addition to issues of production and total rupture, generate shearing and torsion constraints on the sensitive layer leading to cracks or even breaking. As such, the sensitive layer must be thin (and not thick) to limit these constraints.

The majority of these suspended platforms were developed at the beginning of the 2000s and are yet to be adopted by the industry. This is because their lack of robustness means that this type of heating platform and therefore the sensor cannot be manufactured, particularly if it has to be able to function at variable temperatures.

Table 1: Some examples of suspended platforms

Suspended platform	Material	and
--------------------	----------	-----

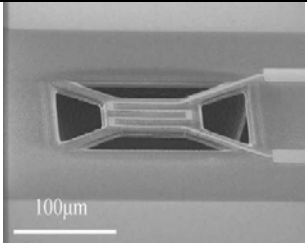
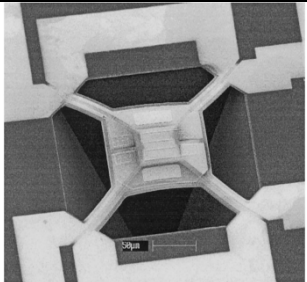
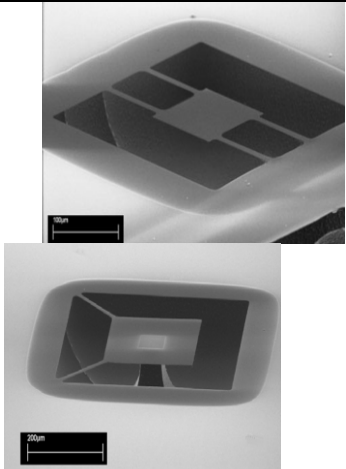
	performance
	<p>Structure suspended by four suspension arms</p> <ul style="list-style-type: none"> • Si substrate • Porous Si membrane 4µm + SiO₂ TEOS • Ti/Pt heater or polysilicon <p>Approx. 15mW required to reach 300°C.</p>
	<p>Structure suspended by four suspension arms</p> <ul style="list-style-type: none"> • Si substrate • SiO₂ thermal membrane • Polysilicon heater • Double SiO₂ insulation layer • Multilayer measure electrodes (Titanium-Tungsten-Gold) <p>Approx. 12mW required to reach 300°C</p>
	<p>SiO₂/Si₃N₄ bilayer structures suspended from two to four arms 100µm x 25µm; thickness of 1µm. used as a base for micro-hotplates.</p>

<p>Fig.1: Platinum metallization layout and dimensions</p>	<p>Circular ($\text{SiO}_2/\text{Si}_3\text{N}_4$) structure, 80$\mu\text{m}$ in diameter suspended from two arms Platinum heater 400°C – 10 mW</p>	
<p>(a)</p>	<p>(b)</p>	<p>Suspended structure with 85μm depth and 10μm thickness. 350°C with 220mW. The structure at 4μm thickness causes consumption to fall to 61mW at 350°C.</p>

- ❖ The ‘closed’ structures shown in fig. 6 consist of an open front on the substrate in order to leave only a fine membrane serving as a mechanical support. The uniformity of temperature distribution on the active surface can be improved (to the detriment of power consumed) by leaving a thermal conductor block (made of silicon, for example) in the active zone as shown in fig.6b). Laboratory research has shown that it is possible to increase temperature uniformity of factor four with a power consumption multiplied by two (for $T=300^\circ\text{C}$, $P= 75\text{mW}$ for structure a) and $P=140\text{mW}$ for structure b)).

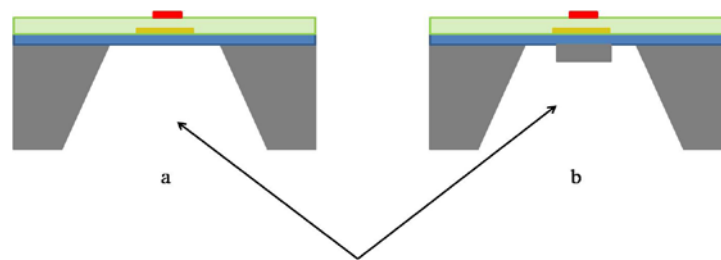

- **Figure 6.** *Closed platform: a) without a silicon block b) with a silicon block*

Some commercial sensors have a structure comparable to that in fig.6a) (without a block). Examples of these include the MICS sensors produced by E2V Sensors. These devices, based on Silicon technology have a heating resistor made of polysilicon or platinum. They require an average energy consumption of 50 to 80mW to reach a temperature of around 350-400°C.

2.4. Technological improvements in the heating layer

So that these heating platforms can reach much higher temperatures (to facilitate and accelerate desorption) whilst maintaining the similar necessary minimum energy (<100mW), a minimal response time (<30ms) and lastly with as few deformations in the membrane as possible, several optimization methods have been explored in research, notably at LAAS-CNRS, focusing on more robust technology for closed membranes.

2.4.1. Membrane: mechanical support and thermal isolation

The first generation of membranes were square and composed of a SiO₂/SiN_x bilayer deposited on two of the substrate's sides (specificity of the deposition technique in furnace). The SiO₂ layer with a thickness of 1,4µm is obtained by thermal oxidation in a furnace with a temperature 1150°C. Lastly, a layer of 0,6µm of SiN_x is deposited by LPCVD at a temperature of 750°C. This technique consists of creating a chemical deposit in a vapor environment with low pressure by injecting SiH₄ and NH₃ gases which react and synthesize the material being deposited with good stoichiometric control (x = 1,2).

To free the membrane, the silicon on the back has to be attacked using Deep Reactive Ion Etching (DRIE). Firstly, this type of etching is not uniform over the whole of the silicon wafer's surface. Generally, etching occurs more rapidly on the edges of the wafer than in the center, resulting in over etching on the periphery. This is an effect of the etching reactor. Nevertheless, uneven etching (under-etching) of silicon on the back side can substitute the silicon blocks which could reach 50µm in angles causing the membranes to curve (fig.7). These phenomena can also be explained by poor thermal transfer or incomplete etching of the silicon.

A third, equally important, point concerns the structures' mechanical aspects. Figure 7 shows important deformations (cross shaped) in the membrane. These deformations are the result of residual constraints due to the superposition of different materials in different technological procedures at higher or lower temperatures (oxidization occurs at 1150°C, thermal anneals at 550°C etc.), required for fabricating the device. In addition to these deformations, others appear during the platform's functioning at high temperatures. Previous research has shown that

deformations can form a 10 μ m arrow during functioning (and 8 μ m when not in use). These deformations can lead to rapid damage in the platform and as such cause problems in the structure's stability. These deformations can also damage the sensitive layer (cracks or even unsticking) therefore affecting the sensor's performance, particularly when the sensor is used in pulsed operating temperature mode.

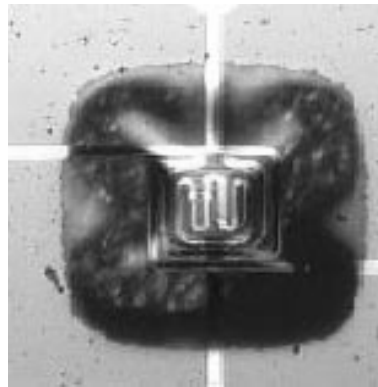

- Figure 7. *Effect of the heater's geometry on the mechanical behavior of the previous platform*

To compensate for these recurrent problems, making the membrane's geometry circular has been explored to suppress the side effects examined previously. Subsequently there have been studies into optimizing the deposition of the SiO₂/SiN_x bilayer in order to minimize the residual constraints in the whole device (of the order of around 80MPa). The decrease in the membrane's thickness minimizes thermal loss which is required to reduce consumption and thermal inertia.

2.4.2. Heating resistance

The architecture studied is based on the platform structure on the closed membrane described previously. The first generation of platforms, like current commercial sensors, had a polysilicon heater strongly doped with phosphorous. These devices, even if they have very good uniformity on the active surface ($|\Delta T|=10^{\circ}\text{C}$ to 15°C), have problems of reliability over time when functioning at around 450°C with inevitable degradation in the polysilicon layer and its interface with metalizations which reduce the sensor's performance (and reduces its lifespan).

In order to solve these derivative problems, studies have focused on replacing polysilicon with platinum which has better thermal properties and is more temporally stable. Its deposition via evaporation or cathodic pulverization requires a bonding layer on the silicon oxide. Titanium is one of the most commonly used

materials in the literature. This titanium/ platinum bilayer has been optimized using the following thicknesses 15nm of Ti and 150nm of Pt following annealing at 550°C.

The rounded spiral design of the (fig. 8) has been obtained after multiple geometries by multiphysical simulation such as COMSOL® in a doctoral thesis by Pamela Yoboue (Univ. ToulouseIII, 2009). This geometry offers a good compromise between thermal uniformity and power consumption, contrary to other geometries used until now (coiled or wound).

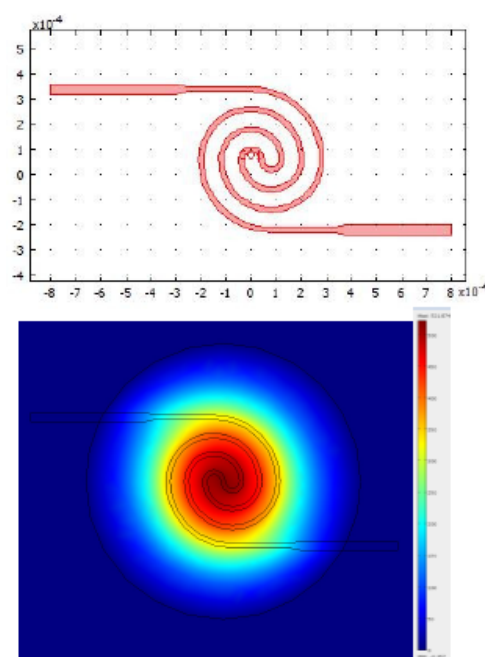

Figure 8. Design of the thermal resistor used in LAAS sensors. An example of thermal simulation

The spiral's rounded form prevents hot points and enables a more even distribution of temperature across the surface. An example of thermal simulation allows us to see even distribution of temperature across the sensor's sensitive zone.

Aside from heat resistance, a SiO₂ passivation layer (deposited by PECVD at low temperatures, 350°C maximum) with 0.5µm thickness is required to electrically insulate the measure electrodes on the surface.

The heater produced can therefore reach an ambient temperature of 550°C in 25ms. Cooling time is of the same order which allows this type of platform to

generate very rapid variations in temperature, making it particularly well adapted for functioning in a sensor in pulsed mode.

2.4.3. Electrodes

Electrodes are mostly produced from titanium/ platinum for their electric and thermal properties using the same procedure as for the ‘heater’. Of the different possible geometries studied in Yoboue’s thesis, a rounded form has been shown to be particular interesting for matching a sensitive layer deposited by drops. The use of interdigitized points is generally employed to achieve better contact between the sensitive layer which generally has strong resistance (fig. 9).

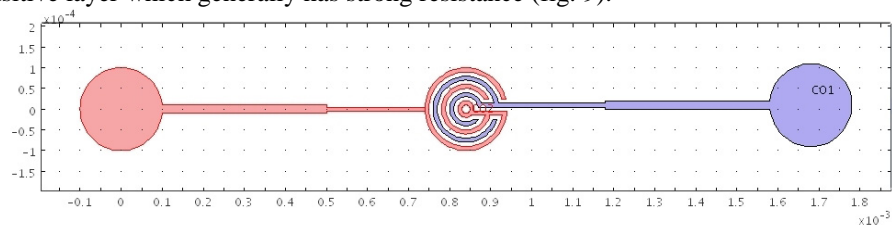

- Figure 9. *Geometry of measure electrodes for LAAS sensors*

A study has also been carried out into the effect of geometry (number of interdigitized points) on the mechanical deformation of the membrane and uniformity of temperature on the sensor’s ‘active’ zone. It has been shown that this kind of structure allows the even distribution of temperature (to the detriment of power required). The only possible limitation is the extra weight added to the membrane but this is not that important overall.

2.5. Integrating the sensitive material

The major disadvantage related to integrating sensitive materials using liquids (currently used to integrate ‘nanomaterials’) remains the non reproducibility of depositions in terms of uniformity, thickness (variability in the concentration of nanoparticles across depositions, issue of sedimentation), alignment and centering. These layers therefore have highly dispersed resistances ranging from a few kilo ohms to several tens of mega ohms.

All these problems make it difficult to control the effective material on a given sensor’s active zone and as such reproducibility from one sensor to another.

‘Inkjet printing’ is a technique which has been used in the literature (as in industry) to draw metal lines or even deposition polymer materials in a structured way on a small scale (of a few μm). The principle of the ink jet is based on

projecting drops of around a picoliter using nozzles of variable diameters (50 μm – 80 μm) and as such is a contactless printing process.

The first research carried out by LAAS consisting of carrying out metal oxide depositions, diluted in ink on an oxidized silicon substrate with measuring electrodes produced from Ti/ Pt as shown in figure 10 to make gas sensors. Instead of writing on a line (normal printing by an inkjet), the jet operates using a predetermined quantity of microdrops which occupy the active zone. For these initial tests, the material used was commercial nano-particled ZnO (Sigma-Aldrich) with grain sizes of between 50 and 70nm.

Integrating the sensitive material into the substrate takes place over three main stages:

- **Stage 1: Surface treatment**

Treating the surface consists of functionalizing the active zone i.e. the electrode's surface (SiO₂ and Ti/Pt) separately from the rest of the tablet. The active surface is left hydrophile whilst the rest of the tablet is rendered hydrophobic by treatment with Octadecyl TrichloroSilane (OTS). To do so, a photolithographic stage is required to protect the area not being treated.

- **Stage 2: Deposition**

Integrating the sensitive layer is carried out using deposit on demand (DOD) technology in the inkjet machine. This device is completely automatic with very good control of all the deposition parameters.

There are **three main influencing parameters** governing the quality of the deposition, notably in terms of uniformity of thickness and localization on the active zone:

- **The deposition temperature** is the temperature at which the 'chuck' takes place in the jet to facilitate the evaporation of ethylene glycol (a solvent). This parameter is important because it plays a role in distributing the particles across the active zone. Depending on temperature, there is a more or less rapid evaporation of the solvent. Too high a temperature will result in uneven distribution of particles (evaporation which is too fast) and degradation in OTS surface treatment.
- **The number of drops.** This can also affect the quality of deposition, notably on the uniformity of the deposited layer with the appearance of a more or less significant 'coffee staining' effect depending on the number of drops ejected.

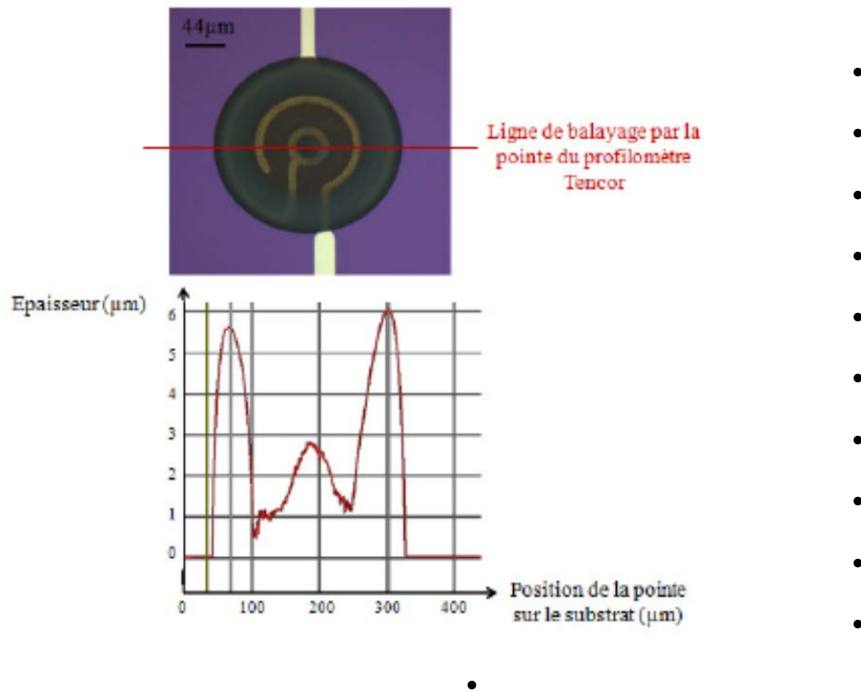

- **Figure 10.** Profile measure using a profilometer- coffee stain effect for a ZnO layer with 80 drops
- **The composition of the ink** is also equally important to the quality of deposition. Tests carried out with ethylene glycol have shown that ink mixed with 2,5% w/w of glycol diethylene in glycol ethylene minimizes the coffee stain effect thus improving uniformity in the ZnO layer.

- **Stage 3: Annealing**

In order to ensure cohesion in the layer, ZnO undergoes annealing in an air oven at 400°C for 20 minutes. Note that this annealing temperature is much lower than that found in the literature which is greater than 600°C.

Similar studies have shown that this technique provides good reproducibility for this type of device from one sensor or tablet to another for the same parameter as well as relatively good uniformity of deposition (with a thickness of $0.5\mu\text{m} \pm 0.15\mu\text{m}$).

2.6. Summary

In this section we have introduced a new generation of heating platforms with significant improvements in relation to existing ones (and commercial products). Improvements have meant that a maximum and stable temperature is 550°C for 65mW i.e. a gain of 100°C in relation to the minimum temperature reached by previous versions. The advantage from a mechanical point of view is also interesting since low deformations create stability in the sensitive element on the active zone, therefore increasing the sensor's life span.

To complete the sensor's production, once the etching stage (or opening the membrane) on the back side has been completed, the tablet is cut to separate each sensor (around 1000 sensors on a silicon substrate with four chips). A resin layer is applied to the surface of the tablet to protect the silicon from chipping. Once completed, the platforms are cleaned in acetone and ready for assembly on a TO5 eight pin casing, as shown in fig.11. The technique employed is 'wedge-bonding' which attaches the sensor to its casing. An aluminum wire of 25µm is lead by a stylet and then applied to the area being soldered. The bond between the wire and the area being connected is carried out in cold temperatures with a combination of pressure and sonar vibration to ensure good electrical contact.

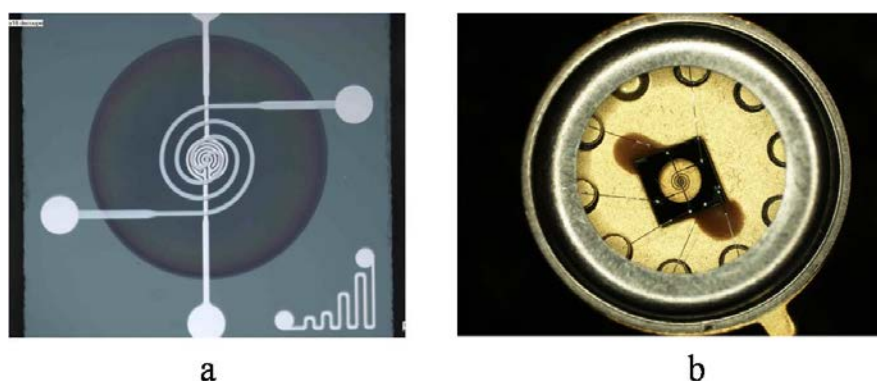

• **Figure 11.** Photos of a) a platform cross section and b) a cased platform

Towards the development of multisensors

As shown in Habib Chalabi's thesis (university Aix MarseilleIII, 2007), 'multisensor' platforms (integrating several heating platforms in a matrix into a single chip) have been developed to move towards the integrated electronic nose. These structures can therefore take one or several sensitive layers and be function together or individually. Several types of platforms have been produced to show

their reliability with 2, 4 and 6 measure cells. Figure 12 is an example of this kind of 4 celled structure.

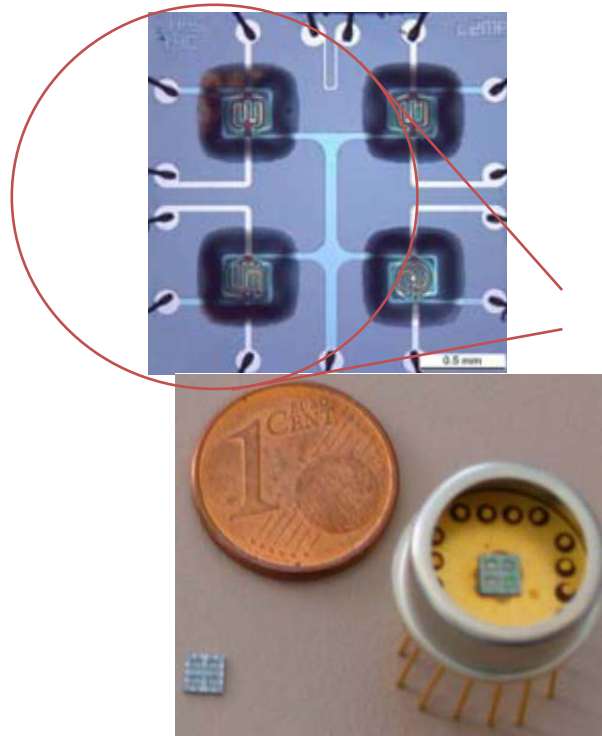

- **Figure 12.** Image of a four celled sensor mounted on a TO-8 16 case

3. New generation of wireless gas sensors

3.1. Introduction

The explosion of the telecommunications market has led to the appearance of new independent wireless sensors at millimetric frequencies which rely on the availability of small sensitive and high performing elements as well as new low cost electronic communication circuits of between 300MHz and 3GHz. These components respond to the growing demand for communicative independent sensor networks for applications such as analysis, diagnostics etc. Of course, gas sensors are part of this and the deployment of a network of autonomous and dispersed gas

sensors in a given environment has a number of applications which as yet have not been explored.

In terms of research, several micro-wave emitting sensors and prototypes of nanometric carbon nanotube transistor sensors have been created. For these sensors, the micro wave signal reflected by a resonator element in the presence of a gas is compared to the occurring micro wave signal. It is at the sensitive element's resonant frequency that the gas' presence becomes evident. As a result, the use of a micro-wave signal in a wide range of frequencies allows us to obtain much more information and data on the interaction between the gas and the sensitive material employed, thereby allowing, in theory at least, better gas sensitivity.

As such, the scientific community focusing on developing communicative gas sensors should be able to combine techniques taken from different fields such as microelectronics, telecommunications and materials. As we will see, the key points of this technology lie in the design and production of autonomous microsensors (low consumption) in the design of the gas sensitive material (still being researched for the improvement of measuring, research and identification techniques. Their development therefore demands technological advances, even breakthroughs which require the use of new knowledge from the three fields: materials, microsystems and hyperfrequencies.

To date, there are surface acoustic wave (SAW) sensors which use the variation in the propagation of the electromagnetic wave by environmental conditions. These sensors are highly sensitive and can function on a frequency range of 300MHz to 3GHz depending on their design. These sensors suffer however from low interrogation distance (several tens of centimeters in general) which means that their use in, for example, spatially distributed sensor networks is unlikely.

As such, today we are seeing an explosion in the market for RFID sensors. RFID refers to 'Radio Frequency Identification'. This technology allows us to identify an object or measure a physical size from a distance using a label which emits radio waves which is either attached or incorporated into the object. The radiofrequency label (transponder, RFID label), is composed of a chip linked to an antenna in casing (RFID tag or RFID label). It is read by a reader which captures and transmits information. However, RFID systems also have several limitations:

- In frequency: they rely on different standards in terms of transmission frequency or necessary power. They function in wave propagation mode and rely on highly specific and regulated frequencies. For example, in the UHF band, RFID systems function either at 868-950MHz, or 2,45GHz.
- In interrogation distance: in the first case (868MHz), communication is limited to a reading distance of a meter meaning that they have a very low range. In the second case (2.45GHz), this frequency is that used by Bluetooth and Wi-Fi. As a result, the standard RFID has difficulties such as anticollision traffic and parasitical reflections.

In addition, in the UHF frequency band allocated to the RFID, there are a number of external elements which are often difficult to identify, but which have to be taken into account such as adsorption phenomena depending on ambient humidity or even the problem of energy autonomy. Lastly, for this RFID UHF technology, there are two serious challenges; the first concerns several tens or even hundred meters of radio ranges, (today ranges are normally lower than 15m) and the second challenge is that of energy autonomy (the energy required for transmission which it has to minimize).

To solve these problems it was therefore necessary to design a new generation of wireless gas sensors using new hyperfrequency modes of transduction by removing itself completely from embedded energy needs which allow sensors to be communicated from distances of several tens of meters. This new generation, designed and created at LAAS will be examined in further detail.

3.2. Detection principle

According to previous studies, the dielectric relaxation phenomenon can be used as a transduction principle in microwave detection systems. This approach uses variations in a material's dielectric properties (permittivity and loss) depending on frequency, notably in terms of hyperfrequencies. This phenomenon has therefore been used for other applications such as integrated MUM (metal-(dielectric) insulator- metal) technologies or other passive functions in integrated HF circuits.

We have therefore proposed a new RF transduction for detecting gas which is based on changing the permittivity of a metal oxide (used as a resonator) by the phenomenon of dielectric relaxation in the presence of gas which therefore causes a shift in frequency at the hyperfrequency filter.

The principle of transduction developed is based on modification, by the size being measured, in a resonator's resonant frequency. Several types of resonators can therefore be imagined: planar resonators in coplanary or microstrip technology or even dielectric resonators. For example, the use of a sensor as a variable element in a filter where the characteristic frequency is read with as high a quality factor as possible in order to have the best level of sensitivity. The principle of our gas detector can therefore be illustrated as in fig.13.

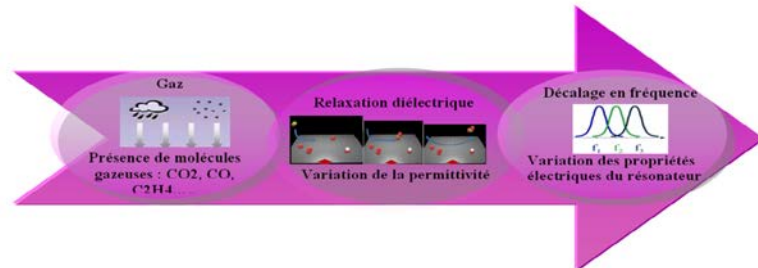

- **Figure 13.** *Illustration of the new RF transduction mode for detecting gas*

3.3. Design structure

As we have seen, the sensor is based on a dielectric resonator (DR) whose dielectric characteristics have been modified by the environment. To obtain the best quality factor possible, we have opted for whispering gallery mode WGM¹ by coplanary lines (100 times greater than those of an excited DR on conventional TE or TM modes). This type of excitation for gallery modes is conveyed by a direct type coupling between the line and the DR. As a result, the coupling can be used to design a direct filter on the bandwidth which allows us to measure gas thanks to the shift in its resonant frequency.

In terms of the filter, the structure is based on coplanar lines on a membrane. These coplanar lines are less dispersive than the microstrip which is interesting for use in millimetric frequencies. On the other hand, the choice of structure on a membrane allows us to minimize losses. The air layer placed on this membrane constitutes the dielectric substrate of the created line. The substrate is therefore transparent regarding the guided wave and the effective relative permittivity of the equivalent transmission is close to the unit. The substrate's low thickness therefore results in a strong decrease of dielectric losses. More favorable propagation conditions are therefore found with TEM mode. A diagram of a cross section of these coplanar lines on a membrane is provided in fig.14.

¹ WGM : Whispering Gallery Mode

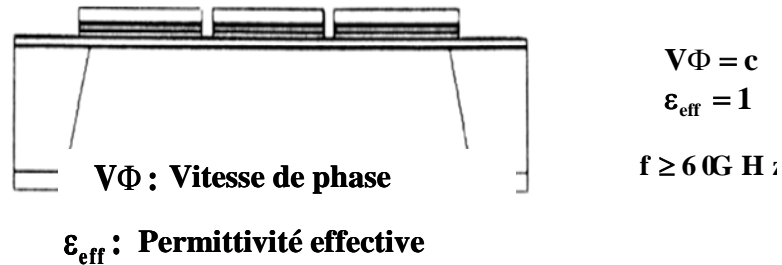

• **Figure 14.** *Cross section of the coplanary lines on a membrane*

The originality of this new communicative gas sensor is based on modifying the resonant frequency of a hyperfrequency resonator (between several GHz and several tens of GHz) in the presence of gas. This can be done using a metal oxide material whose permittivity varies in the presence of a gas by the effect of dielectric relaxation. The potential advantages of this type of transducer are:

- An important reduction in signal loss thanks to direct modulation of the hyperfrequency signal by the size being measured.
- High sensitivity of the electromagnetic propagation to the environment used to create the sensor function.
- High spatial and temporal resolution thanks to increased functioning frequency.
- A more subtle choice of functioning frequency which can be adapted to different constraints on the sensor's use.
- An integration facility in a measuring chain (radar and antennas).

The structure of the gas sensor shown in figure 15a, is therefore based on a structure which is already used in microwave filters. It is composed of two parts: the micro manufactured coplanary lines and the dielectric resonator maintained by a wedge between and above the two lines. The difference here is that the dielectric resonator is not made from silicon but a metal oxide.

As we have stated, this sensor can be considered as a direct filter (fig.15b). The parameters S of such a system depend on the coupling coefficient between the DR and each of the coplanary lines, the attenuation α and the phase ϕ of the wave which is propagated in the resonator.

• **Figure 15.** a) 3D design on the new gas sensor with RF transduction ;b)

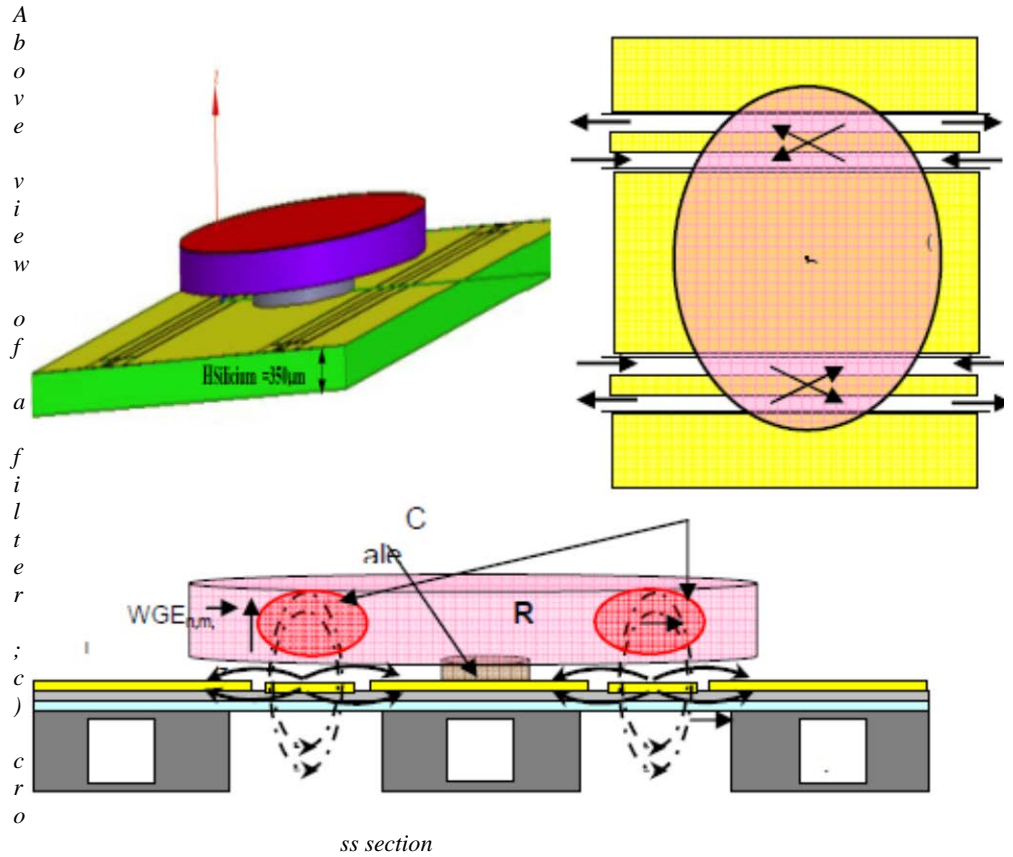

Respectively a et b, are the incidental and reflected waves normalized in the circuit's coupling. If we consider a resonator coupled with one or two transmission lines, two distinct phenomena can be observed:

- Directive coupling occurs between each line and the dielectric resonator (fig.15c).
- A propagation of the wave in the resonator produces an attenuation α and dephasing ϕ . In resonance, this wave turns back on itself and dephasing is therefore $\phi=2n\pi$ where n represents the mode's azimuthal variations.

In line with the distribution of electromagnetic field in the coplanary line and the components of a WGE² field, these are primarily excited in this type of structure. Coupling therefore occurs between the magnetic field of the coplanary line and the fields excited during WGE_{n,m,l} mode.

² WGE mode : In which the electric field is essentially transversal ()

The three integers n , m and l account for the electromagnetic field's spatial configuration inside the resonator (number of variations in the field according to the cylindrical marker's three directions):

- n : the number of variations in the azimuthal direction
- m : the number of variations in the radius
- l : the number of variations in the axial direction

During the design stage, it is necessary to determine the optimal geometry and dimensions of lines, their distribution, the electrical resonator (diameter, thickness), the distance between lines and the resonator (the wedge's height) to obtain the best possible performance (minimal losses, resonances in gallery mode in a good bandwidth, with as high a quality factor as possible etc.).

3.4. Production

The production process for this new sensor can be split into three main parts:

- Creation of coplanary lines on the membrane:
 - Deposition of a $\text{SiO}_2/\text{SiN}_x$ (0.8/0.6 μm) bilayer with low residual constraints
 - Deposition of metalizations in (Ti/Au – 1 μm) by evaporation and then lift-off.
- Creation of the electric resonator:
 - Either from commercial ceramic (BaSmTiOx) such as Temex Ceramics
 - Or a metal oxide (TiO_2) by stereolithography (at CTTC³) or flash sintering (using the PNF2⁴ platform at CIRIMAT)
- Adding the DR to the lines.
 - Gluing the DR using the aluminum wedge
 - Gluing both DR+Wedge on the coplanary lines by Flip-Chip

A more detailed description of the process is detailed by Hamida Hallil in his thesis (Univ. ToulouseIII, 2010).

The following figures provide an example of these processes.

³ CTTC: Centre de Transfert de Technologies Céramiques de Limoges

⁴ PNF2: Plateforme Nationale de Frittage Flash

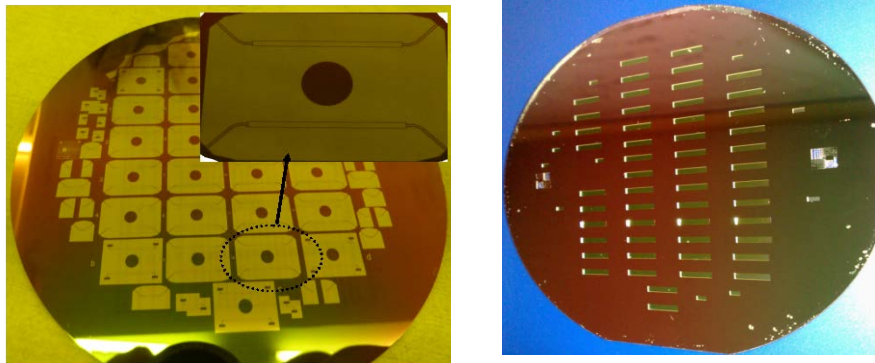

• **Figure 16.** Photo of a wafer with coplanary lines: a) upper face before opening the membrane ;b) the back after etching



(a)



(b)

- **Figure 17.** Photos showing the assembly of the DR (produced by TEMEX-CERAMICS) with the aluminum wedge: a) from left to right: the BaSmTiOxide DR and the aluminum wedge; b) the DR and wedge after gluing

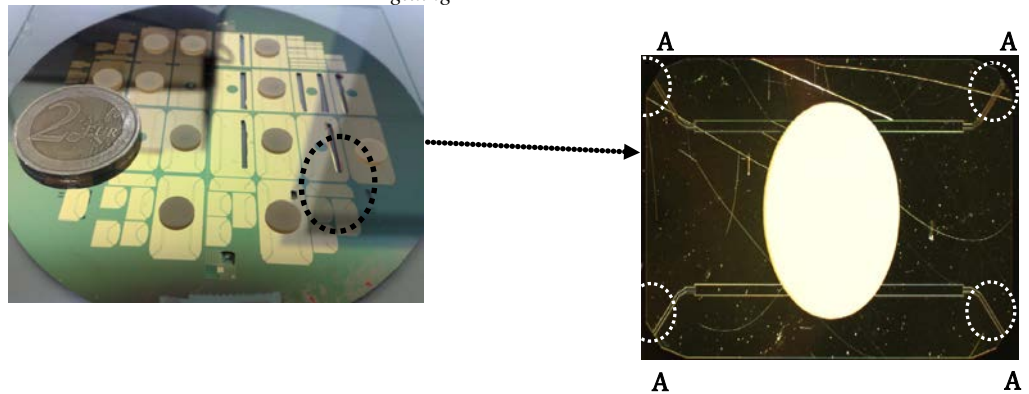

- **Figure 18.** Photos of the first gas sensors with electromagnetic transduction

Whilst some of these sensors have been produced, there is an unavoidable difficulty in the assembly stage of these structures. Perfecting the assembly procedure is essential to guarantee:

- That the DR is well centered between the lines.
- The resonator's flatness and that intervals are uniform (and symmetrical) regarding the two lines.
- The good state of the structure, accounting for the fragility of membranes.

These new sensors which are still being researched use an innovative transduction based on a resonator's dielectric relaxation excited in gallery mode and wireless reading using a 'classic' RADAR.

Applying this to gas detection

In the design of the new sensor examined previously, the electromagnetic field is used to measure the resonant frequency of a gas concentration. The detection principle relies on measuring the resonant frequency of gallery modes (WGMs) in the hyperfrequency dielectric resonator (DR). The dielectric material used is a metal oxide (potentially TiO_2 or SnO_2) whose electrical properties depend on the gas concentration. The adsorption of gas molecules by this sensitive layer leads principally to a more or less significant modification in its dielectric permittivity. Based on the characteristics of the sensitive material being used, it is possible to calculate the concentration of gas from this measure.

Note that the sensor's sensitivity is the combination of the transducer's sensitivity (variation in resonant frequency with permittivity) with that of the sensitive element (variation in dielectric constant (ϵ_r) depending on the concentration of gas). An example of a sensor's response given in figure 19, allows us to calculate its sensitivity represented by the derivative of this curve at any point. We can see that this response is almost linear on the frequency range considered and that this sensor's sensitivity is particularly high (0.2GHz/unit of ϵ_r).

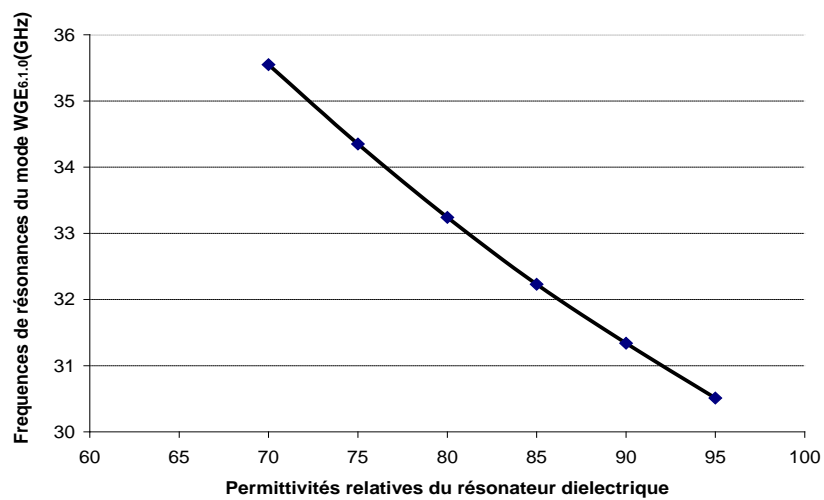

• **Figure 19.** Resonance frequency according to the DR's permittivity (transducer's sensitivity), example of WGH6.1.0 mode

4. Conclusion

In the near future and coming years, ambitious but primarily industrially oriented areas of research will focus on three main axes:

- The integration of new sensitive materials on mono and multisensor structures.
- The development of Multisensor Microsystems allowing the selective detection of chemical (gas or biological) environments.
- The development of new generations of communicative sensors which could be integrated into a sensor network for ambient intelligence, security or even the environment.