



HAL
open science

Dynamics and local extinction mechanisms of a spray jet flame using high speed diagnostics

Antoine Verdier, Javier Marrero Santiago, Alexis Vandel, G. Godard, Gilles Cabot, Bruno Renou

► To cite this version:

Antoine Verdier, Javier Marrero Santiago, Alexis Vandel, G. Godard, Gilles Cabot, et al.. Dynamics and local extinction mechanisms of a spray jet flame using high speed diagnostics. 8th European Combustion Meeting, Apr 2017, Dubrovnik, Croatia. hal-02048210

HAL Id: hal-02048210

<https://hal.science/hal-02048210>

Submitted on 25 Feb 2019

HAL is a multi-disciplinary open access archive for the deposit and dissemination of scientific research documents, whether they are published or not. The documents may come from teaching and research institutions in France or abroad, or from public or private research centers.

L'archive ouverte pluridisciplinaire **HAL**, est destinée au dépôt et à la diffusion de documents scientifiques de niveau recherche, publiés ou non, émanant des établissements d'enseignement et de recherche français ou étrangers, des laboratoires publics ou privés.

See discussions, stats, and author profiles for this publication at: <https://www.researchgate.net/publication/319954530>

Dynamics and local extinction mechanisms of a spray jet flame using high speed diagnostics

Poster · April 2017

DOI: 10.13140/RG.2.2.27264.07684

CITATIONS

0

READS

42

6 authors, including:



Antoine Verdier

CORIA

15 PUBLICATIONS 17 CITATIONS

SEE PROFILE



Javier Marrero Santiago

CORIA

16 PUBLICATIONS 16 CITATIONS

SEE PROFILE



Alexis Vandel

CORIA

27 PUBLICATIONS 156 CITATIONS

SEE PROFILE



Gilles Cabot

Université de Rouen

53 PUBLICATIONS 392 CITATIONS

SEE PROFILE

Some of the authors of this publication are also working on these related projects:



PERCEVAL - Powering The Future with Clean and Future Aero-Engines [View project](#)



TIMBER ANR - Two-phase ignition and propagation in multi-burner combustors [View project](#)

Dynamics and local extinction mechanisms of a spray jet flame using high speed diagnostics

A. Verdier, J. Marrero-Santiago, A. Vandiel, G. Godard, G. Cabot, B. Renou

Normandie Univ, INSA Rouen, UNIROUEN, CNRS, CORIA, 76000 Rouen, France

Context and objectives

Previous numerical studies in simple configurations concluded that the spray characteristics (such as droplet size and the evaporation), the turbulence and the combustion models play a significant role in the flame structure.

→ The simulation of more complex geometries is a difficult task (evaporation & combustion models)

→ Requires several experimental reference flames with well defined boundary conditions.

→ Numerical models development and validation by accurate spatial and temporal experimental data.

The objectives of this work are to study the flame structures and to determine the local extinction mechanisms on a spray jet flame in order to complete the CORIA Rouen Spray Burner (CRSB) database. (<http://www.tcs-workshop.org/tcs6.html>)

Burner characteristics

Canonical spray burner (CRSB) from gaseous KIAI burner geometry

- Liquid fuel: *n*-heptane
- Fuel injector: simplex hollow cone 80°
- Non-swirling air co-flow
- Atmospheric pressure and ambient temperature
- $\dot{m}_{air} = 6 \text{ g} \cdot \text{s}^{-1}$
- $\dot{m}_{fuel} = 0.28 \text{ g} \cdot \text{s}^{-1}$

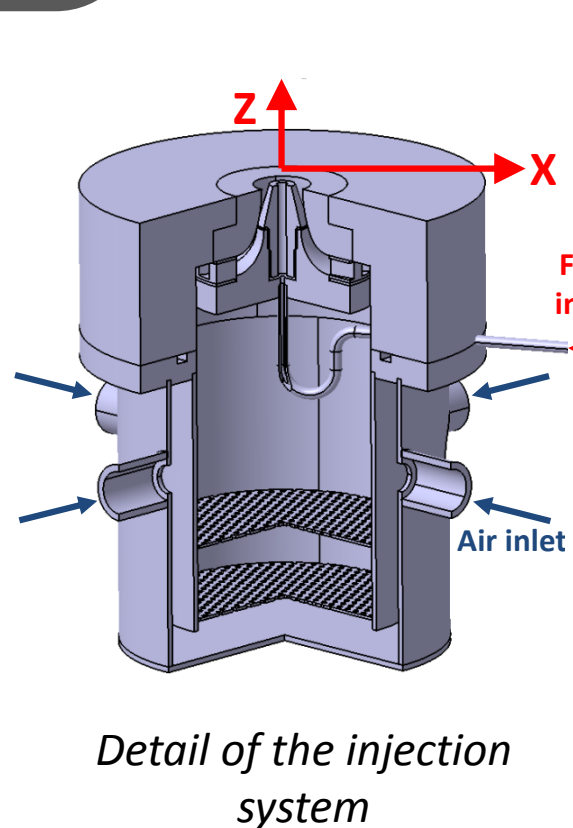

Structure of spray jet flame

Left: Instantaneous OH-PLIF image. Right: ORZ position (black line) and air entrainment streamlines with the norm of velocity

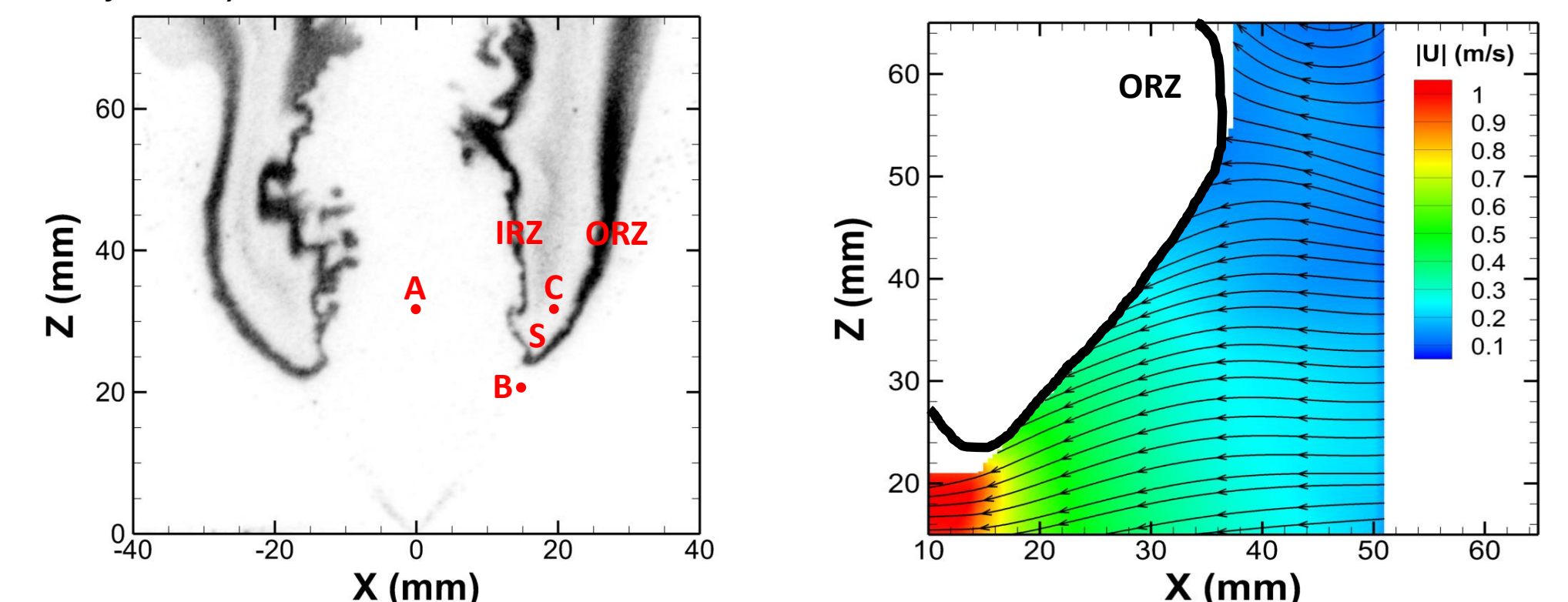

A : Turbulent mixing zone (very small droplets → Fuel lean mixture close to the flammability limit but increases towards the IRZ)

IRZ : Inner Reaction Zone (partially premixed combustion) located along the shear layer.

C : Large droplets moving along the outer part of the spray (fuel reservoir) + burnt gases

ORZ : Outer Reaction Zone → react in diffusion-like outer flame front

S : Leading edge. The stabilization is governed notably by the droplet convection-vaporization, the chemical reaction budgets and the aerodynamic.

Zones of local extinctions in a spray jet flame:

- (1): Extinctions in the IRZ far away from the flame base (turbulence-flame interactions).
- (2): Extinctions in the IRZ close to the leading edge (droplet-flame interactions).
- (3): Perturbations in the ORZ (droplet-flame interactions).

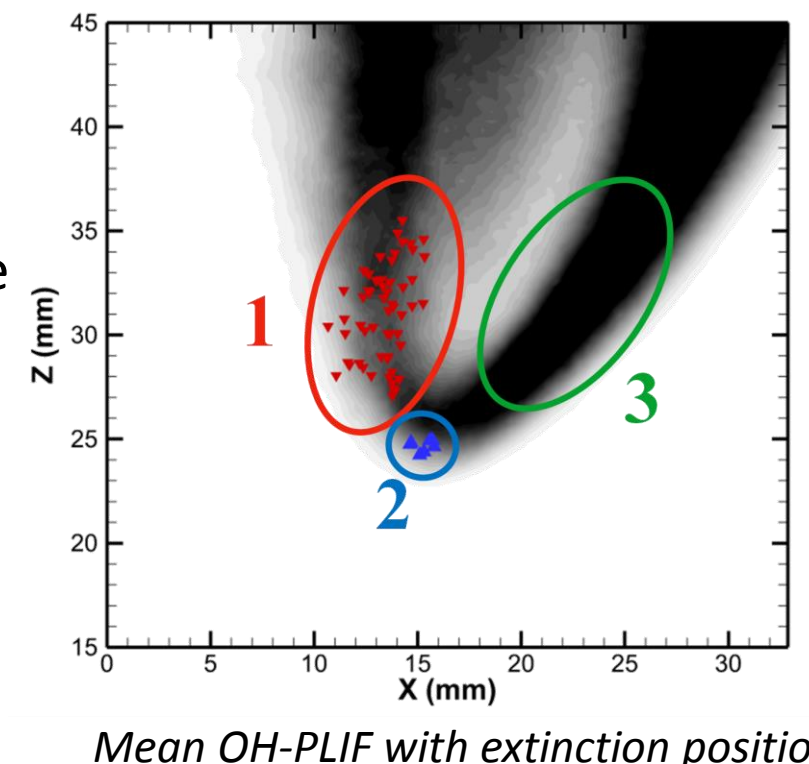

Optical diagnostics

Simultaneous measurements: High Speed Planar Laser Induced Fluorescence + High Speed Particle Velocimetry (HS-OH-PLIF & HS-PIV) : Temporal & spatial flame front positions and associated with instantaneous velocity field.

HS-OH-PLIF:

- Nd-Yag laser with tunable dye laser Sirah Credo ($\lambda=282.665 \text{ nm}$, 380 $\mu\text{J}/\text{pulse}$)
- CMOS camera Photron Fastcam SA5 with High Speed IRO Lavision (896x848 pix²)
- Excitation wavelength : Q1(5) transition $A^2 \Sigma^+ (v' = 1) \leftarrow X^2 \Pi (v'' = 0)$ band of OH
- WG295 and UG11 filter (large band detection strategy)

HS-PIV:

- Nd-Yag laser (Darwin Dual Quantronix) @ $\lambda=527 \text{ nm}$, $f=5 \text{ kHz}$, $\Delta t_{PIV}=10 \mu\text{s}$
- Seeding: solid particles ZrO_2 ($D \approx 1 \mu\text{m}$)
- Post processing: Dantec dynamic Studio, cross-correlation algorithm (32x32, 50% overlap)

Phase Doppler Anemometry (PDA): Fuel droplet size distribution & Fuel droplet size-classified velocity.

- High validation for $Z > 10 \text{ mm}$
- Criteria: 40 000 droplets or 30 s

Optical arrangement for high-speed measurements

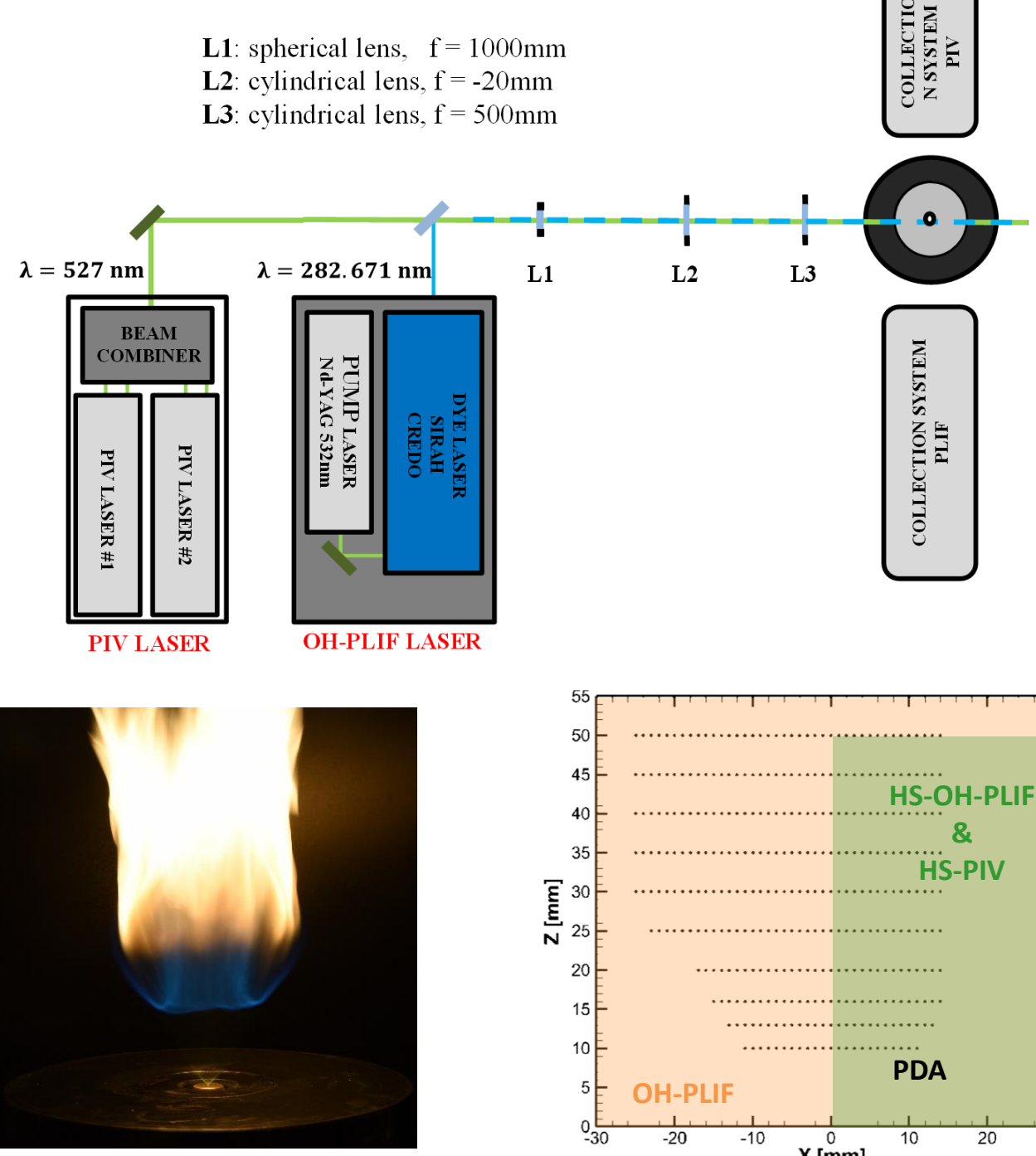

Turbulence – flame interactions

- The turbulent flow generates strong velocity fluctuations in the shear layer.
- Flame stretch by local velocity gradients and lean mixtures can cause the local flame extinction.
- A hole is produced in the IRZ and then is convected downstream.
- The local extinction never leads to a global flame extinction in this configuration.

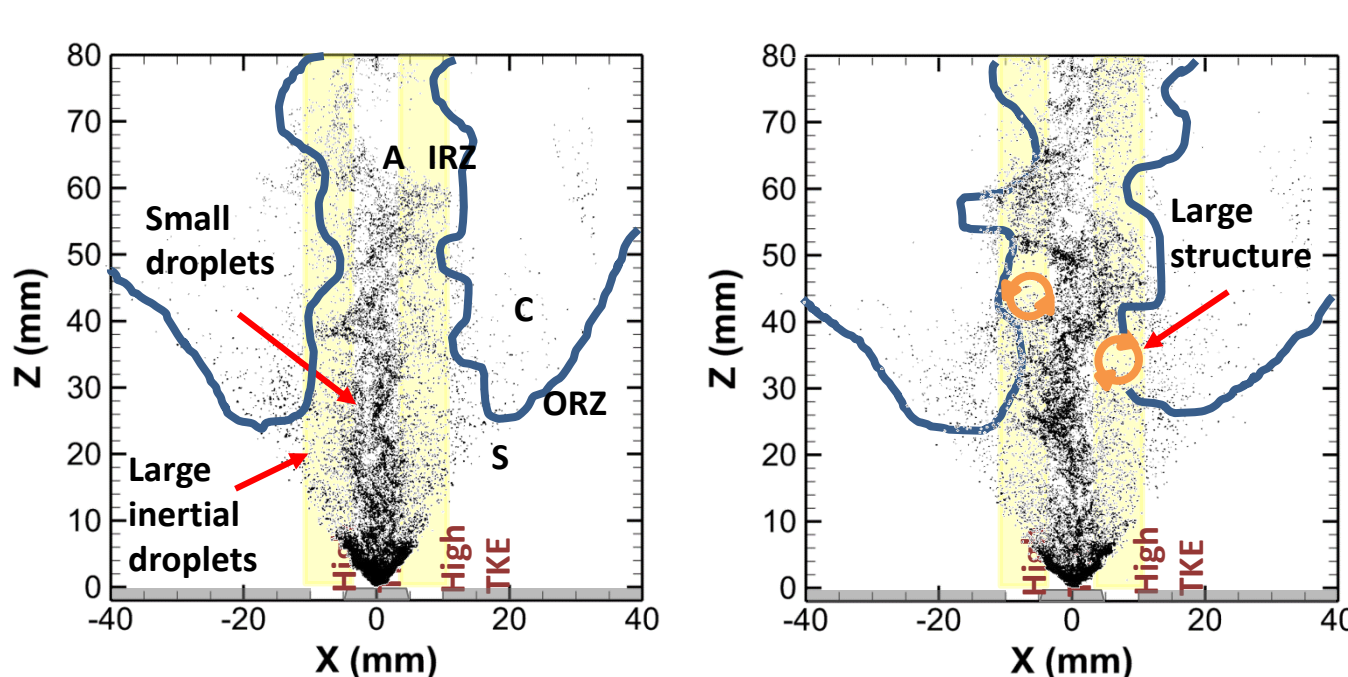

The velocity fluctuations disturb the flame front by a high strain rate. The large structures modify the local mixture properties such as the equivalence ratio until a stable IRZ is no longer possible. → Strong aerodynamic effect on extinction mechanisms

Autocorrelation on velocity fluctuations ($X=13 \text{ mm}$ & $Z=30 \text{ mm}$) in the shear layer

$$\rho_\tau = \frac{u'(t) \cdot u'(t + \Delta t)}{u'^2}$$

$$R_\tau = \lim_{T \rightarrow \infty} \frac{1}{T} \int_0^T \rho_\tau dt$$

→ 82 Hz

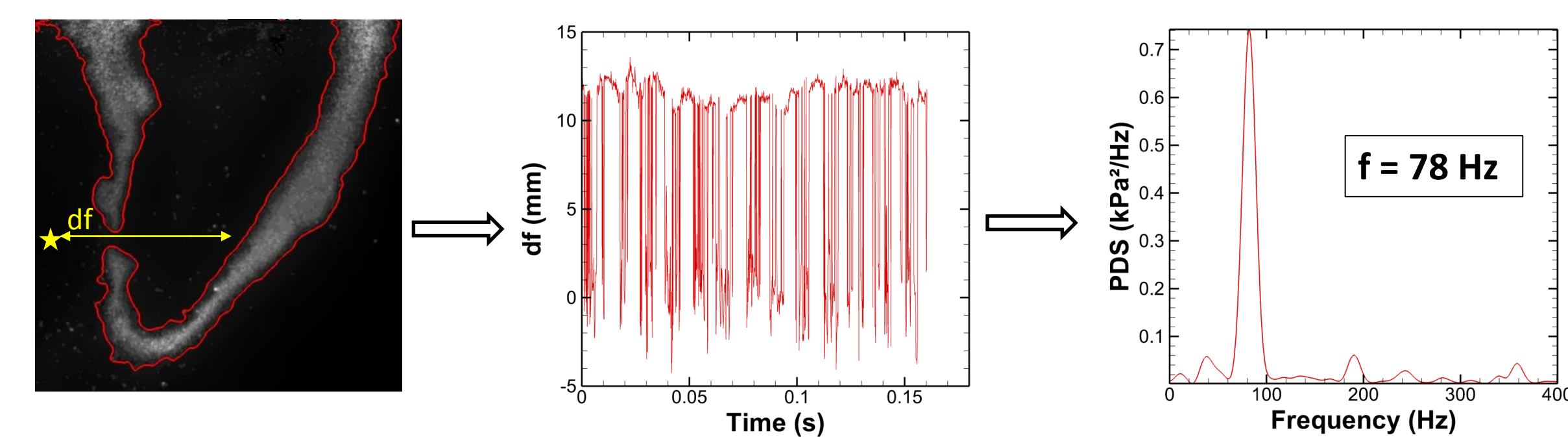

Extinction occurrence frequency analysis. A probe located in $X=16 \text{ mm}$ and $Z=30 \text{ mm}$ is used to determine the temporal apparition of extinction

→ Characteristic frequency: $f \approx 80 \text{ Hz}$

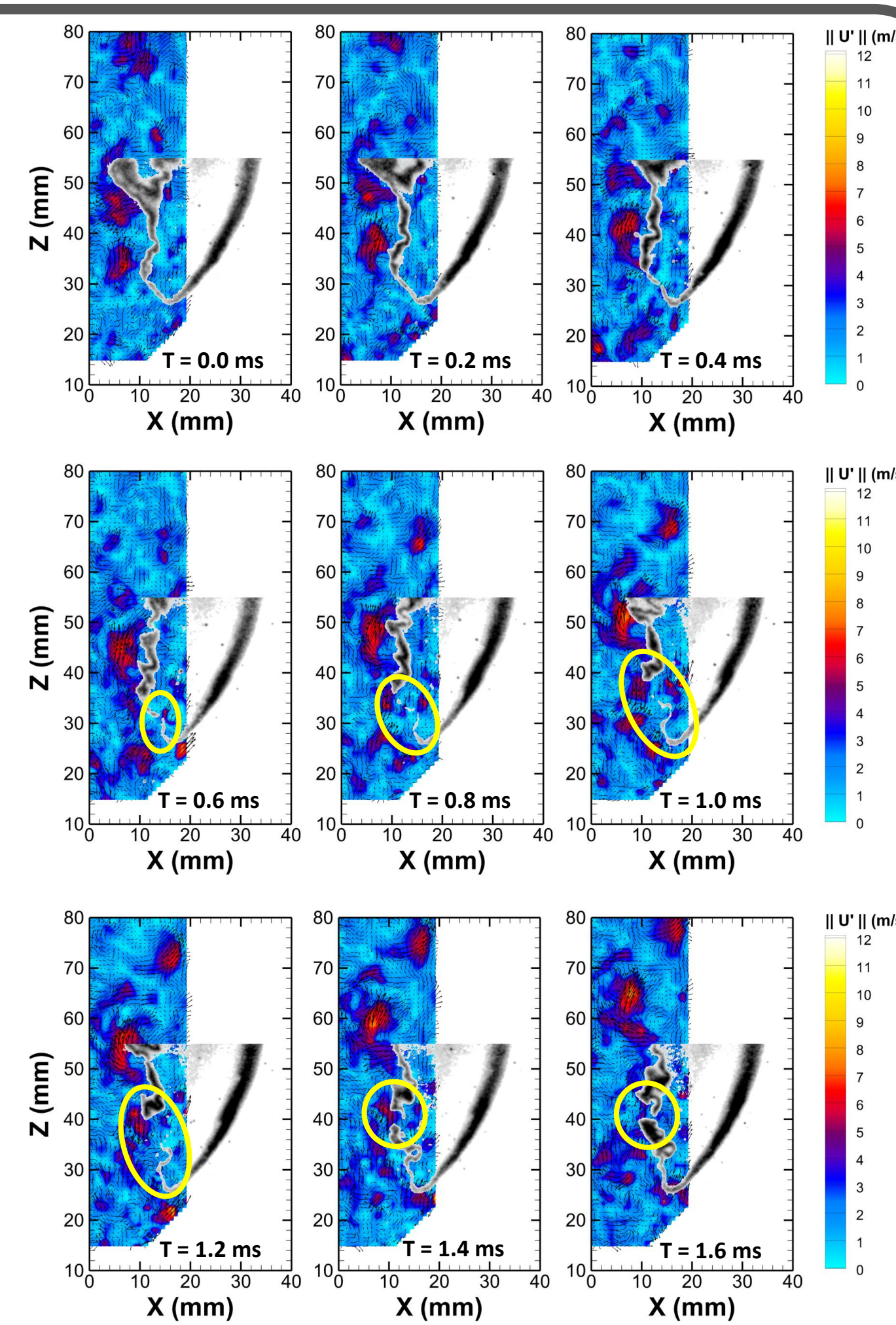

HS-OH-PLIF series images overlaid with fluctuation velocity field and the norm of instantaneous fluctuation velocities

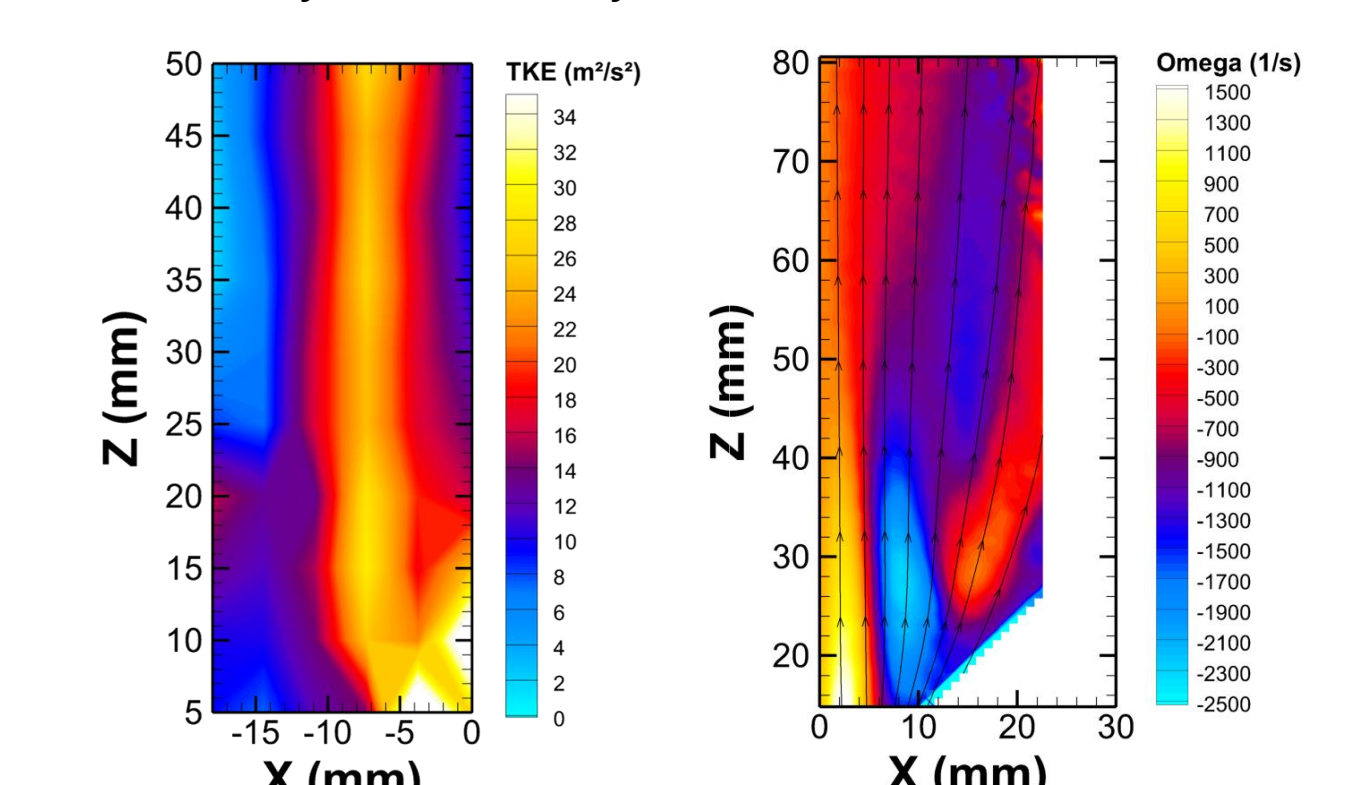

Turbulent kinetic energy of the air in reactive conditions. Mean Vorticity field calculated from HS-PIV images.

Droplet – flame interactions

Fuel droplet mean diameter D_{10} in RC

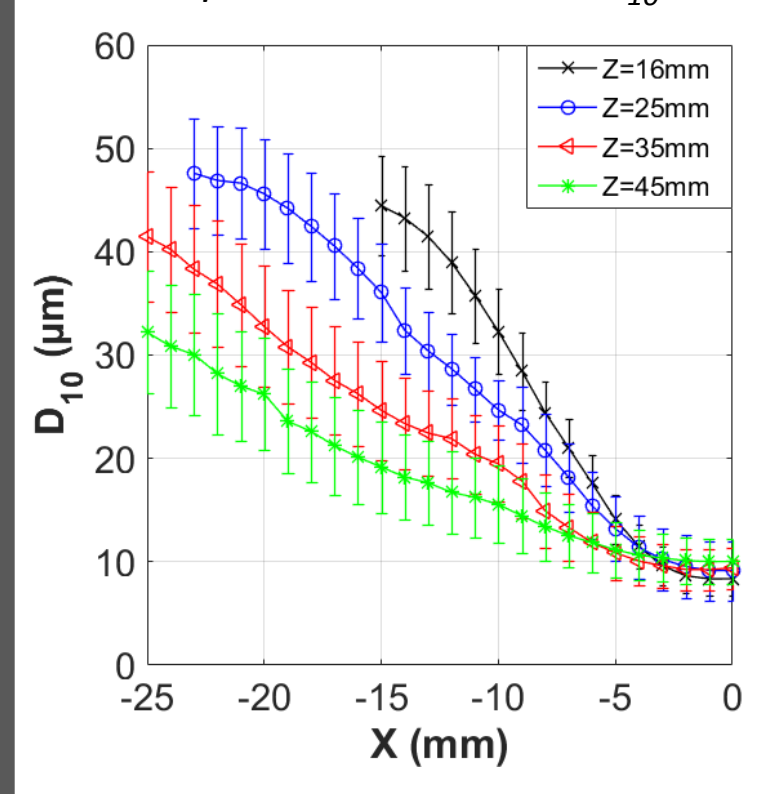

Position (mm)	D_{10} (μm)	\bar{U} (m/s)	$T_{droplets}$ (m/s)
B ($X=18$ & $Z=20$)	45	10	280
C ($X=20$ & $Z=30$)	40	7	320

The flame induces a drastic change in the droplets characteristics:

- ↗ Fuel droplet temperature
- ↘ Fuel droplet diameter
- ↗ Gaseous fuel mass fraction
- ↘ Fuel droplet velocity

Droplet evaporation implies a diminution of local burned gases temperature

- Local quenching due to large heat loss caused by droplet evaporation
- The *n*-heptane vapour around the droplet induces locally a rich mixture which can be superior to the fuel flammability

Selected HS-OH-PLIF images - time separation = 0.1 ms.

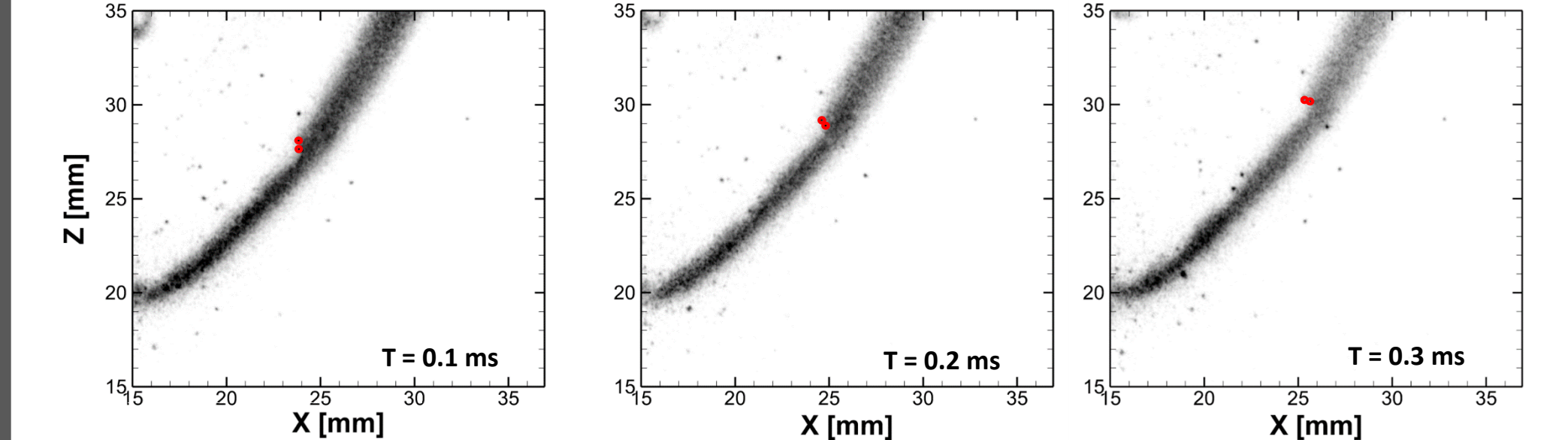

Droplet temperature obtained by GRT technique (Verdier et al) and droplet / air slip velocity

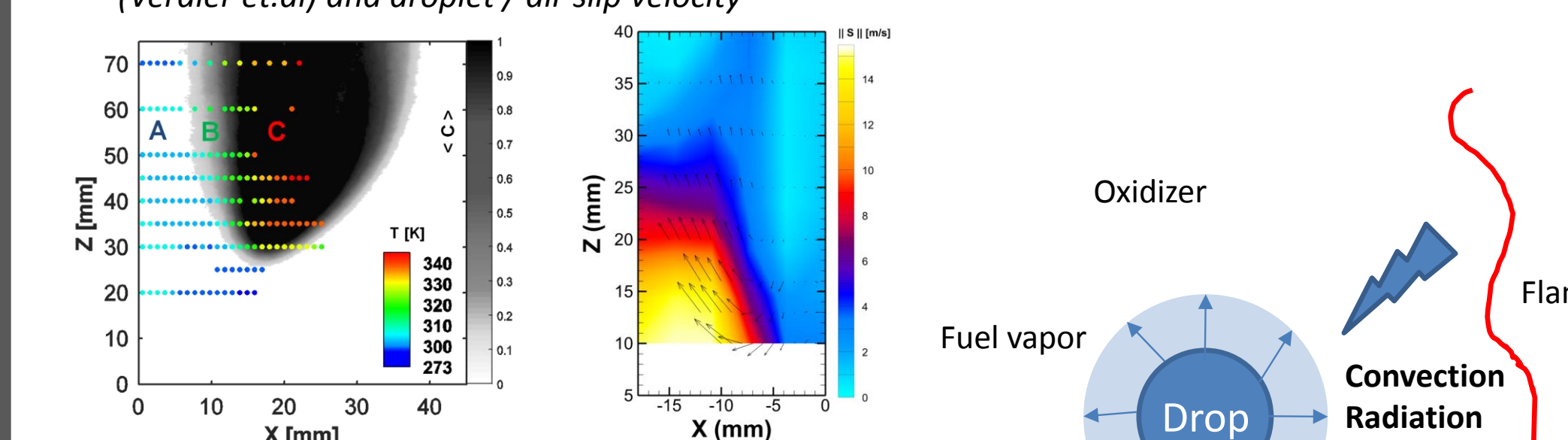

- Big droplets act as a temperature sink for the flame front which finally extinguishes due to the cooling effect

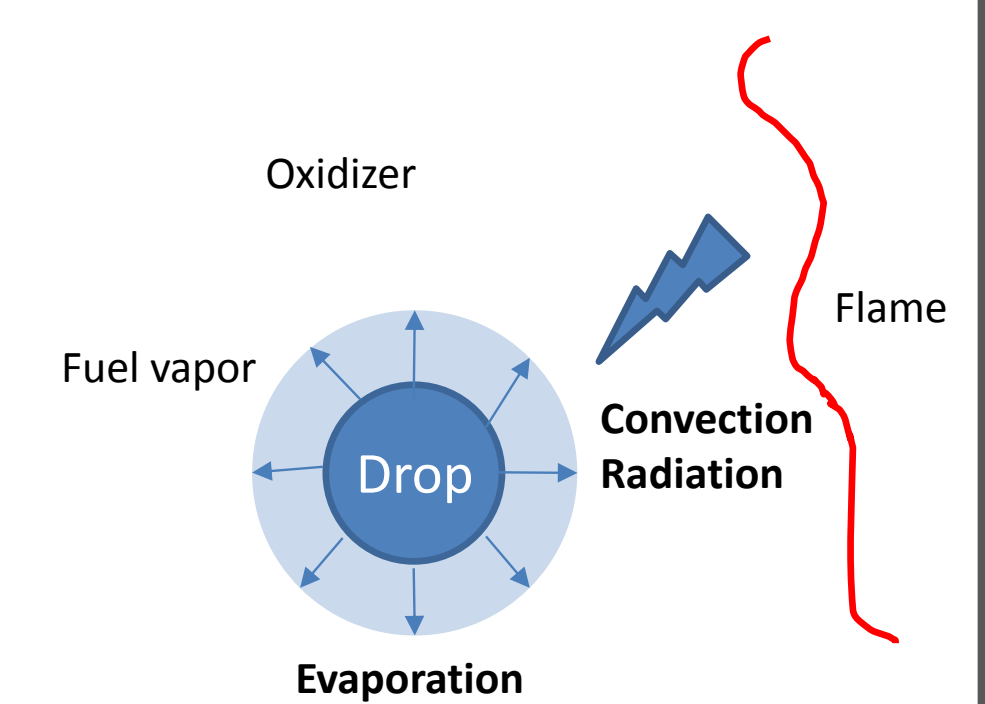

Conclusion

- The sequences of High Speed measurements have sufficient spatial and temporal resolution to follow the evolution of transient phenomena as local extinctions.
- In the IRZ, the temporal evolution of extinction events is correlated with the turbulent velocity fields.
- The turbulent flow generates velocity fluctuations, associated to the shear layer, which greatly influence the flame by momentum, heat and mass transfer. Due to the large turbulent scales, the flame becomes too stretched and the local mixture is below the required condition to sustain a stable flame front, which causes a local extinction
- In the ORZ, the mechanism is related to the droplet-chemistry interactions.
- The big droplets act as a temperature sink for the flame front. Moreover, the mixture inside the droplet wake is too rich

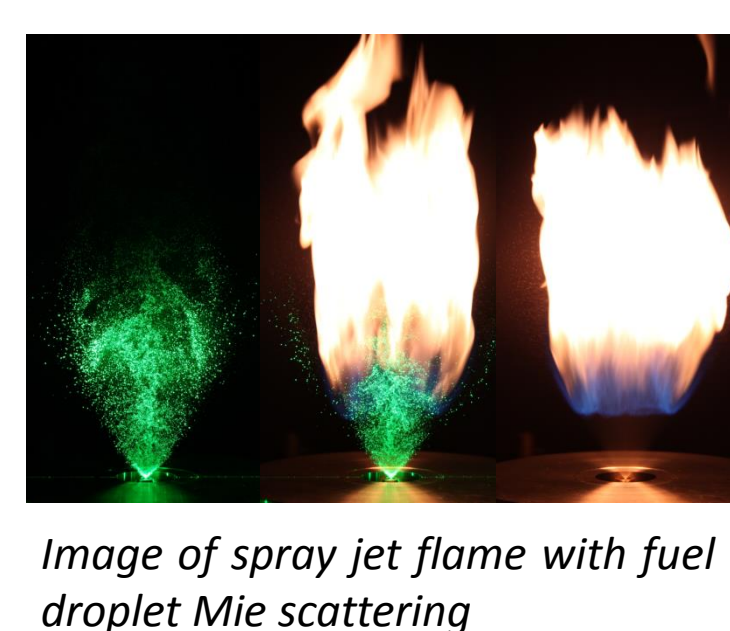

Image of spray jet flame with fuel droplet Mie scattering

References

- A.R. Masri, J.D. Gounder, Turbulent Spray Flames of Acetone and Ethanol Approaching Extinction, Combustion Science and Technology 182 (2010) 702-715.
- A. Giusti, E. Mastorakos, Detailed chemistry LES/CMC simulation of a swirling ethanol spray flame approaching blow-off, Proceedings of the Combustion Institute 36 (2017) 2625-2632. Ma, L. and D. Roekaerts (2016). "Modeling of spray jet flame under MILD condition with non-adiabatic FGM and a new conditional droplet injection model." Combustion and Flame 165: 402-423
- Ma, L. and D. Roekaerts (2016). "Modeling of spray jet flame under MILD condition with non-adiabatic FGM and a new conditional droplet injection model." Combustion and Flame 165: 402-423
- Verdier, A., J. Marrero Santiago, et al. "Experimental study of local flame structures and fuel droplet properties of a spray jet flame." Proceedings of the Combustion Institute
- F. Shum-Kivan, J. Marrero Santiago, A. Verdier, E. Riber, B. Renou, G. Cabot, B. Cuenot, Experimental and numerical analysis of a turbulent spray flame structure, Proceedings of the Combustion Institute, doi:<http://dx.doi.org/10.1016/j.proci.2016.06.039>.