



HAL
open science

Physical-Based Characterization of Noise Responses in Metal-Oxide Gas Sensors

Thierry Contaret, Jean-Luc Seguin, Philippe Menini, Khalifa Aguir

► **To cite this version:**

Thierry Contaret, Jean-Luc Seguin, Philippe Menini, Khalifa Aguir. Physical-Based Characterization of Noise Responses in Metal-Oxide Gas Sensors. *IEEE Sensors Journal*, 2013, 13 (3), pp.980-986. 10.1109/JSEN.2012.2227707 . hal-02045631

HAL Id: hal-02045631

<https://hal.science/hal-02045631>

Submitted on 27 May 2019

HAL is a multi-disciplinary open access archive for the deposit and dissemination of scientific research documents, whether they are published or not. The documents may come from teaching and research institutions in France or abroad, or from public or private research centers.

L'archive ouverte pluridisciplinaire **HAL**, est destinée au dépôt et à la diffusion de documents scientifiques de niveau recherche, publiés ou non, émanant des établissements d'enseignement et de recherche français ou étrangers, des laboratoires publics ou privés.

Physical-Based Characterization of Noise Responses in Metal-Oxide Gas Sensors

Thierry Contaret, Jean-Luc Seguin, Philippe Ménini, and Khalifa Aguir

Abstract—The noise level in the gas microsensors is a tool for characterizing the electrical conduction under various gases and a means to improve selectivity. Metal-oxide gas microsensors with WO_3 sensitive thin film are characterized using a low-frequency noise technique. The spectral form of the noise responses measured using our specific systems is similar for tested gases (ozone and nitrogen dioxide). We observe a clear Lorentzian behavior according to adsorption-desorption (A-D) noise theory. To identify the detected gas, a physical-based characterization model of A-D noise source is proposed and compared with the empirical flicker noise model. We show that the excess noise is due to the A-D processes on the surface of the sensors sensitive film. The Lorentzian parameters depend on the nature of the gases and the noise-level dependence with gas concentration is clearly demonstrated. This confirms the interest on noise spectroscopy to improve the selectivity of gas sensors.

Index Terms—Adsorption-desorption noise, low-frequency noise, metal-oxide gas sensors, noise spectroscopy.

I. INTRODUCTION

NOISE spectroscopy is of great interest for gas detection since it is expected to allow enhanced selectivity of gas microsensors. Indeed, the noise level in the gas microsensors is an indicator of performance but also a tool for characterizing the electrical conduction in presence of gas. Some experimental results have been shown that, using noise spectroscopy, an initially non-selective sensor can be used to analyze the composition of a number of different gases [1]–[3].

In 2005, we published the first attempt to develop a model of adsorption-desorption noise in metal oxide gas sensors [4], based on the simplest adsorption isotherm derived from Langmuir’s theory. Next we improved this model using Wolkenstein’s theory to describe the noise generated by free electron’s density fluctuations in the sensing layer due to instantaneous fluctuations in the number of the adsorbed molecules [5] and adding the effect of mobility fluctuations [6]. The first noise measurements made with different gases in metal oxide gas microsensors with SnO_2 sensitive film were used to validate the consistency of our models [7]. We observed experimentally that the noise is superimposed on the intrinsic noise and could

be described by a sum of Lorentzian component. In this paper, we show new results of low frequencies noise characterization of metal oxide gas microsensors with WO_3 sensitive thin film. It aims to show the interest of noise spectroscopy to characterize measured noise spectra in metal oxide gas sensors in order to improve their selectivity. We will also show that the developed model can explain the measured noise origin.

II. NOISE MODELING IN GAS MICROSENSORS

In metal-oxide gas sensors, noise sources have similar behavior to those present in the devices based on intrinsic semiconductors. On the other hand, the physical origin of noise sources is different and is related to the chemical processes to the surface of the sensitive layer of the sensor.

A. Noise Sources in Semiconductors

- 1) From a microscopic approach, the fluctuations of number of free carriers in a semiconductor generate three noise components: The shot noise due to fluctuations of the carriers that create the conduction current. At low frequencies, the spectral density $S_{I_{conduction}}$ of conduction current $I_{conduction}$ is constant and is written:

$$S_{I_{conduction}} = 2 \cdot q \cdot I_{conduction}. \quad (1)$$

- 2) Thermal noise due to carrier diffusion. It presents a white spectrum. The spectral density $S_{I_{conduction}}$ of diffusion current flowing through the measuring electrodes of the semiconductor is proportional to the conductance G between these electrodes:

$$S_{I_{thermal}} = 4 \cdot k \cdot T \cdot G \quad (2)$$

with k the Boltzmann constant, T the thermodynamic temperature;

- 3) The generation-recombination (G-R) noise caused by the carriers’ number fluctuations associated with the processes of generation and recombination. It’s an excess noise in addition to fundamental noise sources (shot noise and thermal noise). The spectral density of current fluctuations associated with the capture and emission of carriers by a single trap in the bulk semiconductor is given by the relation:

$$S_I = \frac{K_{LF}}{1 + 4\pi^2 f^2 \tau^2} \quad (3)$$

with K_{LF} the current noise spectral density at low frequencies proportional to the G-R induced variation on the current, and τ the average time associated with a trap.

Manuscript received May 20, 2012; revised September 7, 2012; accepted October 29, 2012. Date of publication November 15, 2012; date of current version January 29, 2013. The associate editor coordinating the review of this paper and approving it for publication was Dr. Anna G. Mignani.

T. Contaret, J.-L. Seguin, and K. Aguir are with the Institut Materiaux Microelectronique Nanosciences de Provence, Université d’Aix-Marseille, Marseille 13628, France (e-mail: thierry.contaret@im2np.fr; jean-luc.seguin@im2np.fr; khalifa.aguir@im2np.fr).

P. Ménini is with the Laboratoire d’Analyse et d’Architecture des Systèmes, Université de Toulouse, Toulouse 31062, France (e-mail: philippe.menini@laas.fr).

Digital Object Identifier 10.1109/JSEN.2012.2227707

When the generation-recombination involves interface traps, the phenomenon is called Random Telegraph Signal (RTS). If the fluctuations come from a large number of generation-recombination process, the spectral density approximately varies as $1/f$ in the low frequencies band [8]. The $1/f$ noise or flicker noise is predominant over the thermal noise or shot noise. It involves various energy traps. It is located in the volume [9] or at the surface of semiconductor or at the interface between semiconductor and electrical contact [10]. It is known that the characterization of excess noise in microelectronics devices is a measure of performance and quality. It thus provides relevant information on the traps density, type and location [11].

B. Noise Sources Related to the Chemical Environmental

The main noise sources in the metal-oxide gas sensors are related to the properties of the metal-oxide of the sensitive layer and the chemical environment. In metal oxides, the noise depends strongly on the oxygen stoichiometry and displacement of oxygen atoms. The electronic charge transport is associated with the presence of oxygen at the surface and in the crystal lattice sites of the metal-oxide. The adsorption-desorption process of oxygen atoms and the presence of inhomogeneities, stresses and grain boundaries in the metal oxide cause fluctuations of the oxygen density and, thus fluctuations of the electrical conductance [12].

In a gaseous environment, conductance fluctuations of microsensors due to free carrier's number and mobility fluctuations are thus related to concentration and distribution fluctuations of chemical species. The measured noise spectra result from the superposition of three noise sources contributions.

- 1) The adsorption-desorption (A-D) noise due to the adsorption-desorption of gas molecules. It is similar to the G-R noise in intrinsic semiconductor.
- 2) The diffusion noise related to the diffusion of molecules adsorbed on the surface adsorption,
- 3) The shot noise due to the current through the potential barriers at grain boundaries in the sensitive layer.

C. Adsorption-Desorption Noise Model

The dominant noise source in microsensors is the adsorption-desorption noise [7]. The modeling of the spectral behavior A-D noise source is based on Wolkenstein's theory [13]. Electrical conductivity fluctuations due to free carrier number and mobility fluctuations are proportional to the density fluctuations of adsorbed molecules:

$$S_{\delta\sigma}(f) = \sigma_0^2 S_{\delta N}(f) \quad (4)$$

where $S_{\delta\sigma}(f)$ is the power spectral density (PSD) of electrical conductivity fluctuations. σ_0 depends of free carrier density and mobility at adsorption-desorption equilibrium. $S_{\delta N}(f)$ is the PDS of adsorbed molecules density fluctuation which can be written [13], [14]:

$$S_{\delta N}(f) = H_0 \frac{1}{1 + \left(\frac{f}{f_c}\right)^2} \quad (5)$$

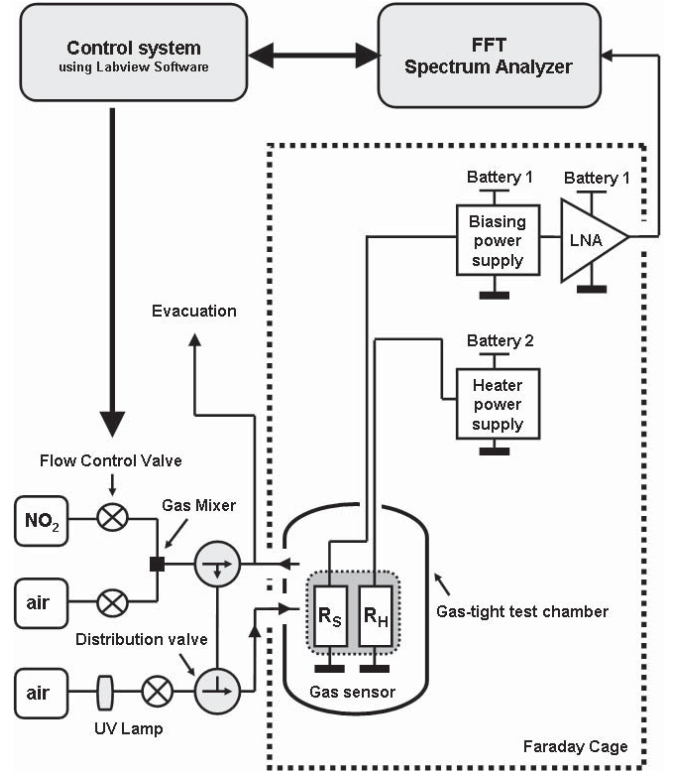

Fig. 1. General diagram of measurements system used to characterize microsensors noise responses.

where

$$\begin{cases} H_0 = 4\overline{\delta N^2}\tau \\ f_c = \frac{1}{2\pi\tau} \end{cases} \quad (6)$$

$\overline{\delta N^2}$ is the mean square value of the adsorbed molecules density fluctuation δN . The time constant τ is

$$\tau = \left[\left(\frac{dd}{dN} \right)_{eq} - \left(\frac{da}{dN} \right)_{eq} \right]^{-1} \quad (7)$$

where a and d are the number of adsorbed molecules and the number of molecules desorbed per unit area, respectively. Whether using Langmuir's theory or Wolkenstein's theory, calculating the time constant shows dependence with the gas parameters (mass of adsorbed molecule, adsorption energy, gas partial pressure ...). Details of the calculation of τ and $\overline{\delta N^2}$ can be found in Reference [6]. So, H_0 and f_c are function of gas species.

For a sensor of resistance R crossed by a current I_0 , the PSD of the fluctuations of the terminal voltage is

$$S_{\delta V}(f) = I_0^2 R^4 \left(\frac{s}{L} \right)^2 \frac{\sigma_0 H_0}{1 + \left(\frac{f}{f_c}\right)^2} \quad (8)$$

where s and L are respectively, the cross section area and length of the sensing layer.

III. NOISE SPECTROSCOPY TECHNIQUE

A. Experimental Setup

The specific noise spectroscopy system which we developed to measure the sensor noise response in air, nitrogen dioxide and ozone is presented in Fig. 1.

The power spectrum of the amplified current fluctuations across the sensor is measured in the frequency range of 0.1 Hz–100 kHz using low noise current preamplifier. The sensors are placed in a stainless steel measurement chamber where mixed gases can be admitted and evacuated via distribution valves. To obtain a linear flow and homogeneous mixture, the incoming gases concentration is controlled by precision electronic flow meters. The gases are then mixed by a diffuser. The gas chamber, the preamplifier, the sensors biasing and the power supply for sensor local heating are incorporated in a Faraday cage. All these devices are battery powered. The configuration and control of the spectrum analyzer with LabVIEW software provide a uniform spectrum in the range of measurement. The gas flow controllers are also supported by LabVIEW.

B. Noise Measurements Results

Experimental noise measurements have been performed on metal-oxide gas microsensors with WO_3 sensing layer. The studied gas-sensitive structures come from the development of a multi-sensors technology involving four cells on one chip.

Each sensor consists of a suspended membrane of $\text{SiO}_2/\text{SiN}_x$. The membrane includes two conductive platinum layers: one as a heater, and a second for the sensing electrodes separated from each other by SiO_2 . A four-microsensor array was developed from this design by duplicating the micro-hotplate and adding bonding pads.

The WO_3 sensing layer was deposited by IM2NP-CNRS laboratory in Marseille on the micro-hotplate fabricated by the LAAS-CNRS lab in Toulouse [15].

To precisely characterize the measured noise responses under gas, it is necessary to evaluate the minimum noise level of the measurements system. This minimum level, often called system noise, is equal to the noise of preamplifier. For a sensibility of 10^{-8} A/V, the noise spectrum of SR570 low-noise current preamplifier is reported in Fig. 2 (curve 4).

The spectrum varies as $1/f$ from 0.1 Hz to 10 Hz and shows a bandwidth up to 200 Hz. Taking into account the sensibility, the current noise is equal to 0.1 pA/ $\sqrt{\text{Hz}}$ at 1 Hz and corresponds to a very low noise level (see section IV-A). In figure 2, we also present the voltage noise spectra under dry air with a constant flow of 100 ml/min (curve 3), nitrogen dioxide (NO_2) with a high concentration of 90ppm (curve 2) and ozone (O_3) with a concentration of 0.2 ppm (curve 1). All measured noise spectra are higher by one or more orders of magnitude compared to amplifier noise level and have a Lorentzian-like behavior.

All series of measurements indicated that the studied sensors were much more sensitive to ozone than to nitrogen dioxide. This explains the low concentration of ozone and those higher for nitrogen dioxide. Moreover, the listing of maximum noise level for each gas presented in Fig. 2 shows that noise decreases when ozone and nitrogen dioxide concentration increases. So, the noise responses clearly vary with the nature and concentration of detected gas.

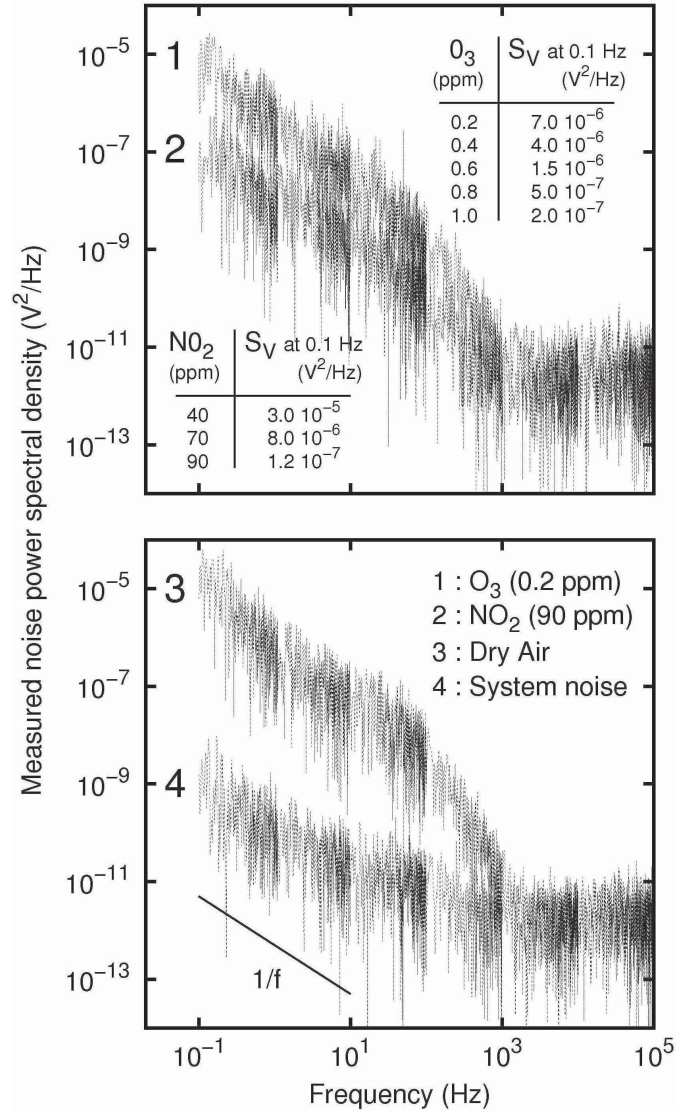

Fig. 2. Voltage noise spectra under air, nitrogen dioxide (NO_2), ozone (O_3), and system noise level.

IV. CHARACTERIZATION OF MEASURED NOISE RESPONSES

The physical-based characterizations of noise responses in gas microsensors consists of two parts, first the acquisition of low frequency spectra in the presence of gas using specific noise measurements system, and, second the identification of each noise source with a spectral decomposition method.

A. Frequency and Noise Analysis of Amplifier

To extract useful information from the measured noise across the sensor in the presence of gas, the noise voltage spectral density is reduced to a noise current spectral density by taking into account the characteristics of low noise amplifier using (1):

$$S_{I_{\text{sensor}}} = \frac{S_{V_{\text{measured}}}}{(A_{LNA}(f))^2} \quad (9)$$

where $S_{I_{\text{sensor}}}$ is the intrinsic current spectral density of sensor, and $S_{V_{\text{measured}}}$ is the noise voltage spectral density

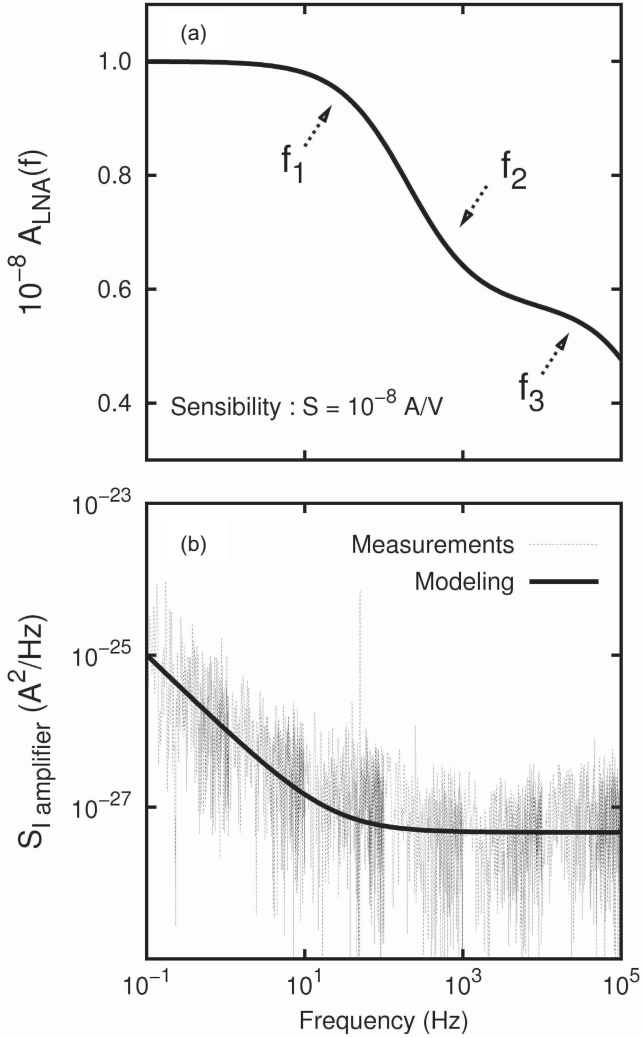

Fig. 3. SR570 low-noise current amplifier for a sensibility of 10^{-8} A/V. (a) Frequencies characteristics. (b) Current noise.

measured across the sensor. $A_{LNA}(f)$ is the measured frequency response of the gain of the low noise current amplifier. Fig. 3 gives the frequency response and the extracted current noise of SR570 low noise current amplifier for the used sensibility.

f_1 is the main cut-off frequency of $A_{LNA}(f)$ caused by the feedback impedance. f_2 is due to the lead network formed by the input and feedback impedances and f_3 reflects the influence of open-loop gain characteristic. The amplifier's noise is generated by the voltage noise source at its input and the feedback resistor. The voltage noise is the sum of flicker noise ($0.1 \text{ pA}/\sqrt{\text{Hz}}$ at 1 Hz) and white noise ($17 \text{ fA}/\sqrt{\text{Hz}}$). The thermal noise associated with the feedback resistor is $13 \text{ fA}/\sqrt{\text{Hz}}$.

All measured spectra clearly show Lorentzian components according to adsorption-desorption noise theory [4]–[6]. Indeed, the noise generated due to the adsorption of a gas on an adsorption site with a given adsorption energy has a Lorentzian spectrum. For both studied gases, we observe that two Lorentzians dominate the low frequency spectrum. The

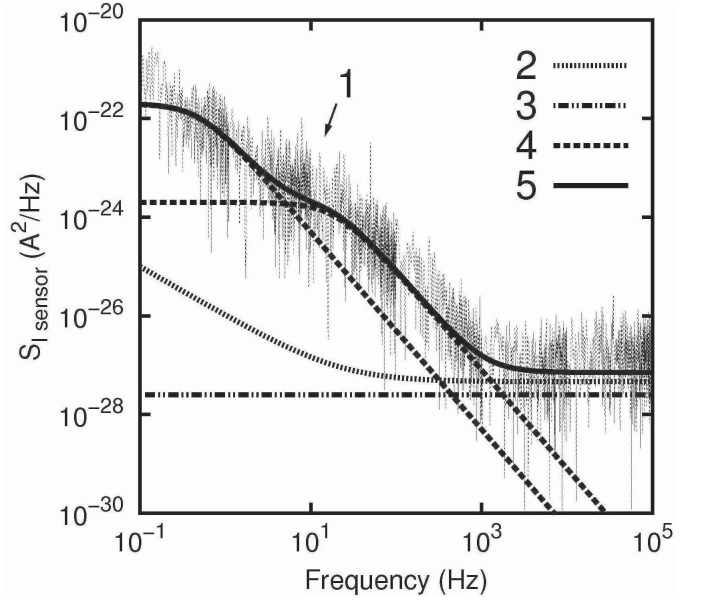

Fig. 4. Spectral decomposition of a noise response under ozone (0.2 ppm). Curve 1: measurements. Curve 2: extracted noise model of low-noise current preamplifier. Curve 3: white noise proportional to the resistance of the sensor. Curve 4: adsorption-desorption noise modeled by Lorentzians. Curve 5: total noise.

TABLE I
EXTRACTED NOISE PARAMETERS

Gas	O ₃ (0.4 ppm)	NO ₂ (70 ppm)
K_1 (A ² /Hz)	$6 \cdot 10^{-23}$	$6 \cdot 10^{-22}$
f_{c1} (Hz)	0.4	0.22
K_2 (A ² /Hz)	$1 \cdot 10^{-24}$	$7 \cdot 10^{-24}$
f_{c2} (Hz)	20	20
K (A ² /Hz)	$1 \cdot 10^{-23}$	$5 \cdot 10^{-23}$
β	1.4	1.4

white noise over 1 KHz is mainly the contribution of thermal noise due to sensitive layer resistance and the thermal noise of the amplifier due to the feedback resistor.

Taking into account the contribution of observed noise sources, the sensor current noise spectral density can be decomposed using the electrical model given by (2):

$$S_{I_{\text{sensor}}} = \sum_{i=1}^2 K_i \frac{1}{1 + \left(\frac{f}{f_{c_i}}\right)^2} + \frac{4kT}{R_{\text{sensor}}} + S_{I_{\text{amplifier}}} \quad (10)$$

where K_i and f_{c_i} are the parameters of each Lorentzian and are related to gas properties and adsorption-desorption process as seen in section II. In particular, K_i depends on the number of adsorbed molecules per unit area at adsorption-desorption equilibrium, and f_{c_i} depends on the time constant of adsorption-desorption process.

Fig. 4 presents a significant example of spectral decomposition by using the modeling of all observed noise source. As Lorentzian parameters of Table I, equation (10) enables to accurately describe the spectral behavior of noise response. In particular, the correct description of the both Lorentzians show that the adsorption-desorption noise is dominant and

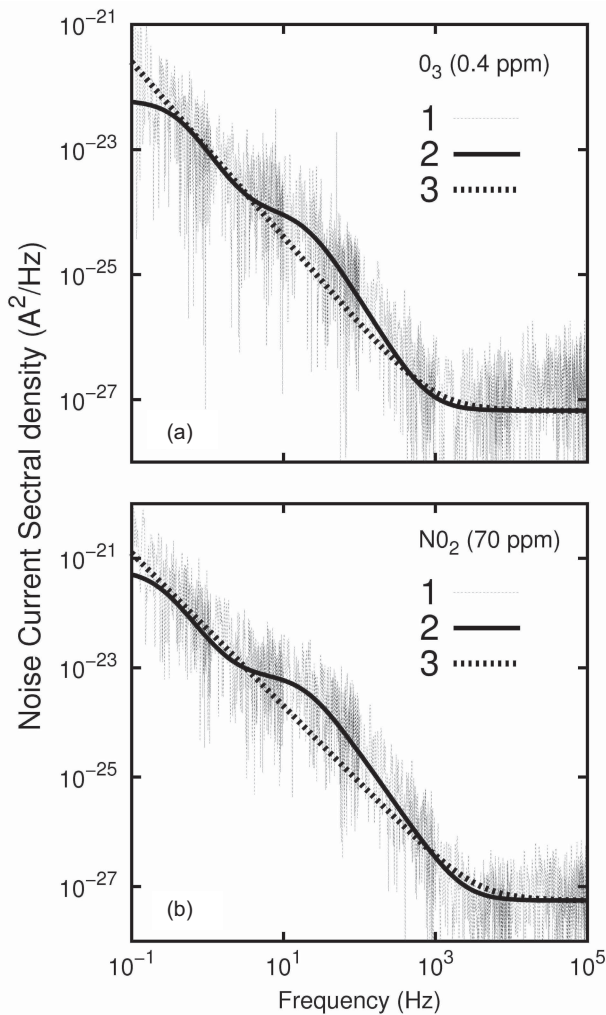

Fig. 5. (a) O₃ gas. (b) NO₂ gas. Curve 1: comparison between measurement. Curve 2: modeling using the adsorption-desorption noise model. Curve 3: empirical flicker noise model.

could be associated to adsorption-desorption process on two types of adsorption sites with different adsorption energy. A study of adsorption sites on WO₃ surfaces would be useful to confirm our opinion, but no data was found in the literature.

To show the consistency and validity of our method, a comparison between the adsorption-desorption noise model and the empirical flicker noise model is given in Fig. 5. The empirical model is described by using (3):

$$S_{I_{empirical}} = \frac{K}{f\beta} + \frac{4kT}{R_{sensor}} \quad (11)$$

where K is a constant proportional with Hooge's constant and β the coefficient of spectrum slope.

The values of noise parameters for both gases measured are reported in Table II. Whatever the detected gas, the empirical model approximately describes the behavior of noise spectra. The empirical flicker noise model does not highlight the observed physical origin of the A-D noise due to some adsorption sites. Such a description would mean that the A-D noise comes from the A-D process on a large number of adsorption sites.

TABLE II
EXTRACTED NOISE PARAMETERS FOR O₃

O ₃	K_1 (A ² /Hz),	f_{c1} (Hz)	K_2 (A ² /Hz),	f_{c2} (Hz)
0.2 ppm	$2 \cdot 10^{-22}$,	0.3	$2 \cdot 10^{-24}$,	20
0.4 ppm	$6 \cdot 10^{-23}$,	0.4	$1 \cdot 10^{-24}$,	20
0.6 ppm	$4 \cdot 10^{-23}$,	0.3	$3 \cdot 10^{-25}$,	20
0.8 ppm	$2 \cdot 10^{-23}$,	0.3	$2 \cdot 10^{-25}$,	15
1.0 ppm	$8 \cdot 10^{-24}$,	0.4	$1 \cdot 10^{-25}$,	20

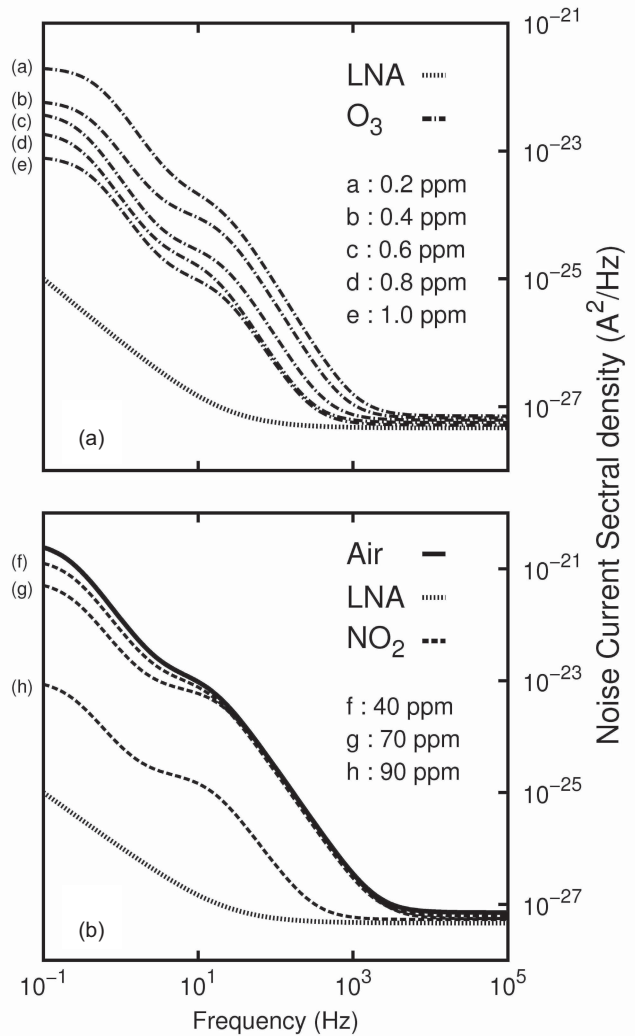

Fig. 6. Modeling of noise current spectral density. (a) Several ozone concentrations. (b) Nitrogen dioxide concentration.

So, by identifying the origin of different noise sources, only the modeling based on the spectral decomposition method can correctly describe the behavior of the noise spectral response of the sensor in the presence of gas.

B. Gas Dependence of Noise Responses

In order to analyze the influence of the detected gases on the noise responses of the studied sensors, we applied the spectral decomposition method to characterize the measured spectra under different concentrations of O₃ and NO₂. Figure 6 shows

TABLE III
EXTRACTED NOISE PARAMETERS FOR NO₂

NO ₂	K_1 (A ² /Hz), f_{c1} (Hz)	K_2 (A ² /Hz), f_{c2} (Hz)
40 ppm	$1.5 \cdot 10^{-21}$, 0.22	$2 \cdot 10^{-24}$, 15
70 ppm	$6 \cdot 10^{-22}$, 0.22	$1 \cdot 10^{-24}$, 20
90 ppm	$1 \cdot 10^{-23}$, 0.22	$3 \cdot 10^{-25}$, 15

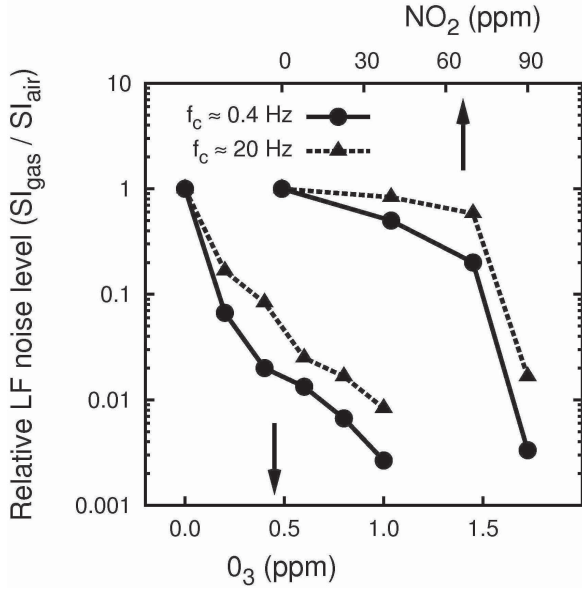

Fig. 7. Relative LF noise level for the both Lorentzian of each concentration of NO₂ and O₃.

the results of noise modeling for five significant concentrations of ozone and three concentrations of nitrogen oxide.

For all concentrations of both tested gases, the modeling of measured spectra clearly identifies two distinct Lorentzians as mentioned in the previous paragraph.

The extracted Lorentzian parameters' are reported in Tables II and III for ozone and nitrogen oxide, respectively. The cut-off frequencies of Lorentzians not significantly depend on the gas concentration but have some variations depending on the gas species. This is consistent with our theoretical approach presented in part II. With regard to LF levels of Lorentzians, we observe dependence with the nature and concentration of gas in according to developed model. Whether under ozone or nitrogen dioxide, the variation of the noise current spectral density is consistent with the variation of the gas concentration. However, the variation range of the spectral density seems approximately the same for both tested gases.

To discriminate the detected gas, we must take an interest in the evolution of LF levels depending on the gas concentration. In Fig. 7, we report the normalized LF noise levels of the both Lorentzians of each modeled spectrum for all concentrations of O₃ and NO₂. The relative LF noise levels are calculated by using following expression:

$$K_{i\text{relative}} = \frac{K_{i\text{gas}}}{K_{i\text{air}}} \quad (12)$$

where $K_{i\text{gas}}$ is the LF noise level (for O₃ and NO₂) of the Lorentzian with the cutoff frequency $f_{i\text{gas}}$ and $K_{i\text{air}}$ is the LF

TABLE IV
EXTRACTED RESISTANCES FOR NO₂ AND O₃

NO ₂ (ppm)	R_{NO_2} (M Ω)	O ₃ (ppm)	R_{O_3} (M Ω)
40	110	0.2	66
70	184	0.4	83
90	236	0.6	110
		0.8	166
		1.0	331

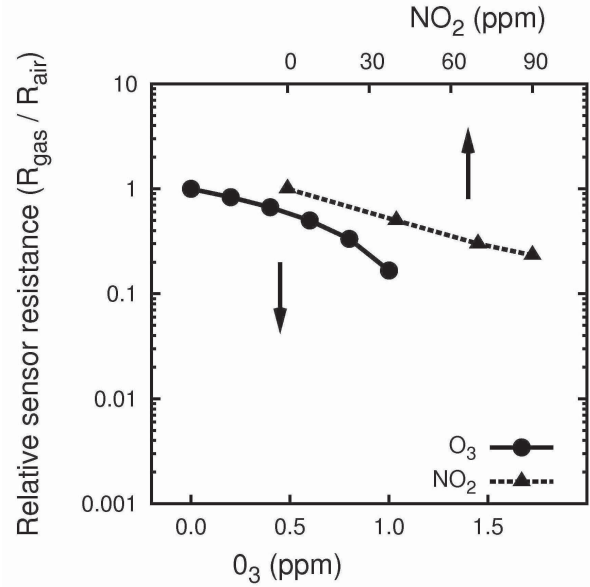

Fig. 8. Relative sensor resistance for NO₂ and O₃ concentrations.

noise level for air of the Lorentzian with the cutoff frequency $f_{i\text{air}}$.

Either with ozone or nitrogen dioxide, the variation of noise levels with the concentration is similar for the two Lorentzians of each spectrum. The dynamic range is greater for the Lorentzian with the lowest cutoff frequency. On the other side, the variation of the levels is very different for the two gases and can therefore be a criterion of selectivity of gas sensors.

In addition, we also observed that the maximum dynamic range of noise levels is roughly the same for ozone and nitrogen dioxide and seems to be rather a characteristic of the sensors used. The ozone concentrations differ from those of nitrogen dioxide due to different sensitivity of the sensor for the both gases.

To highlight the possibility of noise spectroscopy to improve the selectivity of gas sensors, we extracted the value of sensors resistance from the thermal noise level observed from 10 KHz. The values of sensors resistance are reported in Table IV for each ozone and nitrogen dioxide concentration and, are consistent with the resistance values directly measured in a previous study [15]. Ozone and nitrogen dioxide being oxidizing gases, we verify an increase in sensor resistance when the concentration increases.

From the value of sensor resistance under air, we plotted in Fig. 8 the relative resistance depending on the ozone and

nitrogen dioxide concentration. If we compare the figures 7 and 8, we immediately see that variation range of relative sensor resistance is less than a decade while the noise level variation range is about three decades. The detection of gas by measuring the variations in the noise levels would therefore be more sensitive and selective than sensor resistor measurement.

V. CONCLUSION

In this paper, a physical-based method to characterize the noise responses of gas sensor has been presented. Experimental noise measurements have been performed on metal oxide gas microsensors with a WO_3 thin-film and a platinum micro-hotplate. Using specific measurements system, the sensor noise response under gas exposure is measured in low frequencies range.

To analyze the power spectrum of the amplified current fluctuations across the sensor, we developed a noise model based on Wolkenstein's theory. Using spectral decomposition, the modeling of noise current spectral density enables to explain the origin of excess noise and gives more information on the detected gas. Lorentzian behavior of the measured spectra is correctly taken into account by using the description of adsorption-desorption process of gases. We have shown that the dependence of noise parameters with the nature and concentration of gas is consistent with the theory of adsorption-desorption noise. The most relevant result of our study is the largest dynamic range of noise levels variation relative to sensor resistance variation.

So, these results show the growing interest in the development of noise spectroscopy technique to improve the selectivity of gas sensors.

ACKNOWLEDGMENT

The authors would like to thank A. Combes from IM2NP/CNRS UMR 6242/Aix-Marseille University, Marseille Cedex, France, for technical support. They would also like to thank LAAS-CNRS, Toulouse, France, for their collaboration in the development of the advanced microsensors used in this work.

REFERENCES

- [1] L. B. Kish, R. Vajtai, and C. G. Granqvist, "Extracting information from noise spectra of chemical sensors: Single sensor electronic noses and tongues," *Sensors Actuat. B*, vol. 71, no. 1, pp. 55–59, 2000.
- [2] J. L. Solis, G. E. Seeton, and Y. Li, "Fluctuation-enhanced multiple-gas sensing by commercial Taguchi sensors," *IEEE Sensors J.*, vol. 5, no. 6, pp. 1338–1345, Dec. 2005.
- [3] L. B. Kish, Y. Li, J. L. Solis, W. H. Marlow, R. Vajtai, C. G. Granqvist, V. Lantto, J. M. Smulko, and G. Schnera, "Detecting harmful gases using fluctuation-enhanced sensing with Taguchi sensors," *IEEE Sensors J.*, vol. 5, no. 4, pp. 671–676, Aug. 2005.
- [4] S. Gomri, J.-L. Seguin, and K. Aguir, "Modelling on oxygen chemisorption induced noise in metallic oxide gas sensors," *Sensors Actuat. B*, vol. 107, no. 2, pp. 722–729, 2005.
- [5] J. L. Seguin, J. Guerin, and K. Aguir, "Adsorption-desorption noise in gas sensors: Modelling using Langmuir and Wolkenstein models for adsorption," *Sensors Actuat. B*, vol. 114, no. 1, pp. 451–459, 2006.
- [6] S. Gomri, J. L. Seguin, J. Guerin, and K. Aguir, "A mobility and free carriers density fluctuations based model of adsorption-desorption noise in gas sensor," *J. Phys. D, Appl. Phys.*, vol. 41, no. 6, pp. 065501-1–065501-11, 2008.
- [7] T. Contaret, S. Gomri, J.-L. Seguin, and K. Aguir, "Noise spectroscopy measurements in metallic oxide gas microsensors," in *Proc. IEEE Sensors*, Oct. 2008, pp. 200–203.

- [8] H. Wong, "Low-frequency noise study in electron devices: Review and update," *Microelectron. Rel.*, vol. 43, no. 4, pp. 585–599, 2003.
- [9] F. N. Hooge, T. G. M. Kleinpenning, and L. K. J. Vandamme, "Experimental studies on $1/f$ noise," *Rep. Progr. Phys.*, vol. 44, no. 5, pp. 479–532, 1981.
- [10] A. L. McWhorter, *Semiconductor Surface Physics*, R. H. Kingston, Ed. Philadelphia, PA: Univ. Pennsylvania Press, 1957.
- [11] T. Contaret, K. Romanjek, T. Boutchacha, G. Ghibauda, and F. Boeuf, "Low frequency noise characterization and modeling in ultrathin oxide MOSFETs," *Solid-State Electron.*, vol. 50 no. 1, pp. 63–68, 2006.
- [12] A. K. Raychaudhuri, "Measurement of $1/f$ noise and its application in materials science," *Current Opinion Solid State Mater. Sci.*, vol. 6, no. 1, pp. 67–85, 2002.
- [13] T. Wolkenstein, *Electronic Processes on Semiconductor Surfaces During Chemisorption*, R. Morrison, Ed. New York: Consultants Bureau, 1991.
- [14] Z. Djuric, O. Jaksic, and D. Randjelovic, "Adsorption-desorption noise in micromechanical resonant structures," *Sensors Actuat. A*, vol. 96, nos. 2–3, pp. 244–251, 2002.
- [15] H. Chalabi, P. Menini, E. Scheid, L. Salvagnac, V. Conedera, K. Aguir, and K. Ngo, "Development of integrated smart nose based on wo_3 gas sensors," in *Proc. EuroSensors XX*, vol. 2, 2006, pp. 112–113.

Thierry Contaret was born in Saint Germain-en-Laye, France, in 1975. He received the Ph.D. degree from the University of Montpellier II, Montpellier, France, in 2003, with a thesis on noise modeling and simulation in submicron metal oxide semiconductor transistors.

He joined the MicroSensors Group, Institut Matériaux, Microélectronique, Nanoscience de Provence, Marseille, France, in 2006, after a Post-Doctoral Research with the Institut de Microélectronique Electromagnétisme et Photonique, Grenoble, France, on noise characterization of advanced metal oxide semiconductor field-effect transistor. His current research is on improving the selectivity of gas sensors by using noise spectroscopy.

Jean-Luc Seguin was born in France in 1958. He received the Ph.D. degree with a thesis on adsorption and wetting on graphite, and the Habilitation à Diriger des Recherches degree from the University of Aix-Marseille II, Marseille, France, in 1983 and 2000, respectively.

He is a Senior Researcher with Paul CEZANNE - Aix-Marseille III University, Marseille. He is a Senior Lecturer on electronics with the Institute of Technology of Marseille, Marseille. He specializes in thin films preparation and characterization for applications in microsystems. Since 1997, he has been interested in gas microsensors and he developed a selective ammonia sensor based on CuBr mixed ionic conductor. He is currently with the Institut Matériaux Microélectronique Nanosciences de Provence, Marseille, on WO_3 gas sensors and selectivity enhancement strategies, including noise spectroscopy.

Philippe Ménini was born in Toulouse, France, in 1970. He received the Ph.D. degree in electronics from Paul Sabatier University, Toulouse, in 1998. His doctoral studies were concentrated on characterization and modelling of capacitive pressure sensors.

He has been an Assistant Professor with Paul Sabatier University since 1999. He joined the Laboratoire d'Analyse et d'Architecture des Systèmes du Centre National de Recherche Scientifique, Toulouse. His current research interests include microtechnology, analogue IC for Microsystems, instrumentation, electrical modelling, and design of microelectromechanical systems.

Khalifa Aguir received the Doctorat d'Etatès Sciences degree from Paul Sabatier University, Toulouse, France, in 1987.

He is a Professor with Aix Marseille University, Marseille, France. He is currently the Head of Sensors Group, Institute of Materials Microelectronic Nanosciences of Provence, Aix-Marseille University, Marseille. His current research interests include metal - oxide (WO_3 , SrTiO_3 , CuO , CeO_2) and organic thin films for gas sensors, flexible gas sensors, microsystems, selectivity enhancement strategies including surface modification of sensors, signal treatment, adsorption - desorption noise spectroscopy, modelling of sensor responses analysis, and low noise amplifier design.