



HAL
open science

A knowledge-based intelligent decision system for production planning

Rafiq Ahmad, Stephane Tichadou, Jean-Yves Hascoët

► **To cite this version:**

Rafiq Ahmad, Stephane Tichadou, Jean-Yves Hascoët. A knowledge-based intelligent decision system for production planning. *International Journal of Advanced Manufacturing Technology*, 2017, 89 (5-8), pp.1717-1729. 10.1007/s00170-016-9214-z . hal-02042551

HAL Id: hal-02042551

<https://hal.science/hal-02042551v1>

Submitted on 6 Jan 2025

HAL is a multi-disciplinary open access archive for the deposit and dissemination of scientific research documents, whether they are published or not. The documents may come from teaching and research institutions in France or abroad, or from public or private research centers.

L'archive ouverte pluridisciplinaire **HAL**, est destinée au dépôt et à la diffusion de documents scientifiques de niveau recherche, publiés ou non, émanant des établissements d'enseignement et de recherche français ou étrangers, des laboratoires publics ou privés.

A knowledge-based intelligent decision system for production planning

Rafiq Ahmad¹ · Stephane Tichadou² · Jean-Yves Hascoet³

Abstract This paper presents a Knowledge-Based Intelligent Decision system (KIDs) that takes information from a vision sensor within the manufacturing process and generates automatic planning/path-planning decisions in for collision avoidance in virtual CAM production. In this paper, the integration of KIDs approach is presented in the context of conventional multi-axis machining. The proposed system would be implemented in the conventional machining processes and, in this paper, its future implementation in the context of STEP-NC-based CAM systems is also discussed. This contribution provides secure solutions that can detect and avoid collisions using multiple solutions including tool diversion strategy, but also offers many other opportunities such as process change, sequence change, plan change, etc. A bi-turret machining scenario is used as a test case, where two tools working together possess a synchronization issue. Multi-tool synchronization cycles during preparation should take into account the management of materials left on the work part. The proposed solutions allow multiple opportunities where the machining units (blank groove) can be enriched with new associated data such as uncut material (identified visually) that may cause collisions during production. It is not limited however and therefore could be integrated into the STEP-NC in

CAM simulation environment where the system is gaining acceptance from industry.

Keywords Multi-axis CNC machines · Safe tool-paths generation · Collision detection and avoidance · Image processing · Machine intelligence

1 Introduction

Multi-axis, multi-tool, multi-workpiece, multi-channel, multi-programming and hybrid (Mill-Turn) machines have been developed to adapt to the daily demand of high-speed production for compact and complex process planning with a minimal number of setups. The integration of more processors and turrets as shown in Fig. 1 for complex parts production increases the complexity of the process and hence, the risk of collisions between different production tools, a tool with unfinished workpiece, or tools with other machine elements. The integration of multi-turret and multi-spindle in a single machine [16, 18] vouch for the complexity of such machines, where multiple tools might work on the same workpiece at the same time. These machines are capable of precise production with time efficiency but the increase in complexity increases the need for the machine intelligence (automatic work and reaction). An intelligent, fast, and automatic decision-making process is required to avoid unwanted situation such as collisions during virtual and real production. The current method of human intervention can be avoided the in multi-axis Computer Numeric Control (CNC) machine production processes as well as its associated Computer-Aided Manufacturing (CAM) virtual simulations (preparation) for collision avoidance. The unavailability of such intelligence causes the potential risk

✉ Rafiq Ahmad
rafiq.ahmad@ualberta.ca; engrrafiq@gmail.com

¹ Mechanical Engineering Department, University of Alberta, Edmonton, Canada

² SYMME University of Savoie, F74000 Annecy, France

³ Ecole Centrale de Nantes, Nantes, France

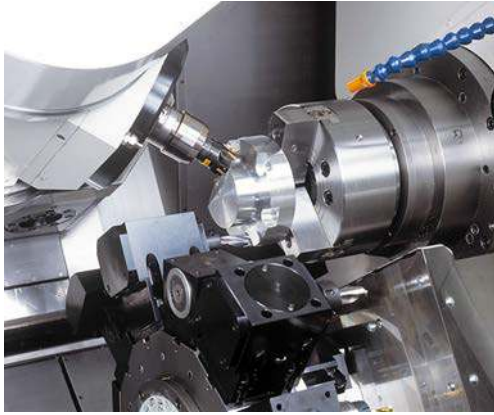

Fig. 1 Multi-axis machine (Super-NTX 5)

of collisions, and hence machinery damage and production stops.

In the state-of-the-art machining technologies, human intervention exists in many processes but the knowledge-based decision approach presented in this paper will focus on the intelligence during CAM collision avoidance for non-functional (speed displacements) tool-paths [1, 3, 4, 10], for multi-tool working on the same workpiece with the prospect of application to real manufacturing. A recent development [19] highlights the practical applicability of the collision prevention systems, which further increases the need to investigate multi-tool synchronization.

The problem of collisions Collision is an important problem for multi-axis machines because the current machining technologies lack proper feedback systems between different processes and hence a minor difference between the real and virtual scenes may cause collisions in the real production [8]. Operator mistakes and machine complexity are the other important causes of collisions [3, 4]. The state-of-the-art approaches [20] for existing CAM software and multi-axis machines are capable of detecting collisions but are unable to automatically provide safe solutions for their avoidance. During multi-tool synchronization CAM software is unable to provide a better solution for collision detection and avoidance. Current CAM software products (TopSolid - Missler) are not able to take into account the evolution of the workpiece during production, especially for tool collisions verification with the unfinished part of the workpiece.

Many existing CAM software products verify tool-paths while simulating the real process but they propose no automatic solution for avoidance when a collision is detected [2, 4, 5, 15, 19, 20]. Sometimes one simulates a process with ideal conditions but there are always a lot of important factors that need to be taken into account. For example, one

normally takes the pre-defined (once defined to the CAM system) dimensions of the machine-tool or workpiece in our simulation process but in reality tools and workpiece dimensions vary and, as a result, there exists the chance of collision. Sometimes, the software shows a collision but in fact there is no real problem of collision.

Conventional CAM systems are not only limited for automatic collision avoidance but in some scenarios even collision detection could be a problem. The CAM software is able to detect collisions when a trajectory is programmed for a single production tool, but when multi-tool trajectories are synchronized, the software cannot even detect such collisions. The most important collisions during tool synchronization are collisions with unfinished parts of the workpiece. This is due to the lack of system intelligence during multi-tool synchronization.

2 Related work

Researchers [11, 20] across different disciplines have been focusing on the problem of collisions. The most popular concepts in this regards are elastic string [13, 17], generalized pattern search algorithm [6], and A* method (extension of Edsger Dijkstra) [7, 14] in robotics. These methods work fine for collision detection but multi-axis CNC machines, especially multi-tool synchronization, is a much more difficult challenge. C-space [12, 15] is one of the approaches used both in robotics and machine-tools for collision detection, which uses 2D grids data. However, the method is not suitable in its current form for automatic collision avoidance, especially when dealing with a workpiece undergoing continuous updates.

Xu [22] developed a feature extraction system to take a STEP-NC files as input for feature-based process planning activities. STEP-NC feature-based programming is a hierarchical data structure that contains product geometry, working-steps, and machining parameters for parts manufacture. The authors presented a survey of the interoperable, open, and intelligent CNC machine-tools using STEP-NC. They believe that availability of design data at the machining stage enables a reliable collision check, accurate simulation, and feedback from the machining stage to the design stage.

Visibility data-based vision approaches [21] proved to be better for extracting the real information about the scene for collision detection but multi-tool synchronization and collision avoidance are not taken into account. Vision-based tools and methods [2, 5] are good options for offline path planning in the context of multi-axis machine-tools because of their many advantages [4] such as exact information extraction, adaptability, and equipment costs. The limitation

of vision-based approaches lies in the availability of a robust sensor in the market. Vision systems are also limited for real-time control of the machining environment, where the formation of chips and lubricant might not allow online surveillance. However, for offline path planning, vision data is an image of the working volume taken at a single instant, e.g., initial status of machine before processing, which can be used for CAM correction.

The developed methods for collision detection and avoidance [1, 2, 4, 5, 19] are applicable to static scenarios where one tool is working on a workpiece and the rest of the objects (tools) present in the scenario are considered as obstacles. Although some dynamic solutions [3] are proposed, when multiple tools are working in the same environment and on the same workpiece, the problem becomes more complex, and therefore, a more general approach is required so that the aspect of evolution of a workpiece is taken into account. Currently, multi-tool synchronization may create collision problems with the unfinished parts of the workpiece, which is not taken into account by the CAM software and is not even treated in the literature.

The objective of this paper is to provide multiple solutions that might be applied in the case of collisions, which will enhance the multi-axis machine-tool (Mill-Turn) collision free trajectory generation for CAM. The proposed method uses knowledge from the vision system and manufacturing and proposes solutions for automatic collision detection for conventional CNC machining. This paper also provides guidance for the future implementation in STEP-NC data model for CAM systems. The proposed Knowledge-Based Intelligent Decision system (KIDs) is an intelligent tool that will make the behavior of the machine-tool (virtual) more intelligent in order to respond quickly to the problems related to collisions. This system will automate the machine preparation processes, increasing autonomy during safe productions. It will also provide solutions to the operator for re-planning the trajectories when a collision is detected.

3 Knowledge-based intelligent decision system (KIDs)

A Knowledge-Based Intelligent Decision system (KIDs) is devised, which takes information from the vision sensor, manufacturing data from the CAD/CAM and CAPP i.e. machine strategy and initial path already planned from the G-code. After having this information, the system verifies expected collisions by using the developed knowledge. In the case of collisions, a feasible solution is proposed from various possibilities, such as an automatic safe detour around the obstacle.

3.1 How KIDs works?

The KID system will provide extra security to machining process with continuous surveillance of the scene. The proposed possibilities of solutions include intelligent decisions as follow:

- Changing the process plan such as changing the number or type of machines for processing
- Changing the strategy or sequence of operations
- Changing the process itself
- Changing the tool position around the obstacle to a secure position

The two important steps of KIDs include the following: information extraction and knowledge development; and collision detection and avoidance methodology. First, data is collected from the different counterparts of the manufacturing process, which gives knowledge about the process and then based on that information, expected collisions are detected with a devised methodology.

3.1.1 Information extraction

The data extraction and interpretation is the most important process to define the scenario at hand and clarify the risk of collision and also help in the decision of a proper action to generate a safe machining process. The following knowledge information data shall be required for an effective decision:

- Data for part (workpiece) or object model can be extracted from the CAD such as gross workpiece, final shape and updated information of the workpiece,
- Data regarding operation strategies, operation sequence, and process can be obtained from CAM simulations and the STEP-NC data model [26],
- Data for setups and machine architecture can be obtained from CAPP and STEP-NC [25],
- Data regarding tool-paths are captured from CAM and G-code,
- Object detection and identification data to differentiate between the potential obstacles are captured through image processing and knowledge data,
- Data about specific processes such as turning and milling can be obtained from process information from the CAM and G-code, and also ISO standards such as ISO14649, Part11 [28] and ISO14649, Part12 [29] respectively,
- General process data can be obtained from ISO14649, Part10 [27].

The flowchart of KID system shown in Fig. 2, clearly indicates the data extraction from manufacturing process,

Fig. 2 KID system flowchart

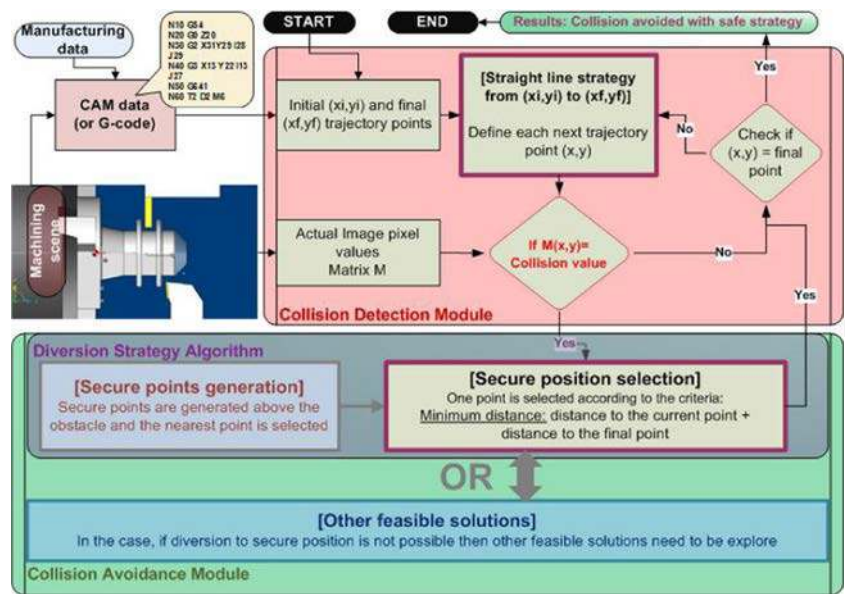

G-code, and vision system actual data. The information data extraction is partially automated. For example, different objects and their associated features are stored in the database manually. Data from the G-code and information from fresh image pixels are extracted through the Matlab program and stored in the database automatically.

3.1.2 Knowledge development

The data obtained previously are stored in a database created in the Protegee Software. Relations are developed between different data-sets stored in the database and rules are defined to associate data into their product families. For example, speed is associated with a specific tool and axis of the machine, where, as a rule, the maximum speed limit cannot be crossed. Relations are created between different data and linked in the form of an informal ontology. Currently, no standard is applied to the knowledge ontology but future work will cover the interoperability issue of formal ontologies across different domains. However, the knowledge-base is accessible from Matlab (computational tool) where a decision methodology is implemented to select a feasible solution for the collision problem. Knowledge is generated out of the data specified in the database and the developed rules. For example, a reference image stored in the database contains a workpiece, tool, and machining setup, which are represented by pixel values. Once a new image is taken with a new object in the scene, its associated pixel values are compared with the base image and finally an object is detected with the fresh and previous data. Once a new object is detected in a fresh image, its contour/feature information

helps in finding the object in the database. When the information about the new object is found in the database, its associated information can provide further details about its mission in the scene. With enough information about an obstacle, the proposed methodology then searches for a feasible solution to avoid the unwanted situation and continues to process automatically.

3.2 KIDs methodology

Once the important data are obtained about the process, the actual scene data can be captured using the vision system. The image information obtained from the scene is used to detect different objects in the scene and, by using the machine strategy and the initial path, the future positions of the tool are calculated to check if they will encounter any of the obstacles in the scenario matrix as shown in the methodology flowchart in Fig. 2.

3.2.1 Collisions detection

The fresh image obtained is transformed into a binary image with Matlab, where 1's representing objects and 0's free space. The trajectory generation process then verifies whether the next path point lies on the obstacle location. In the case, if the next trajectory point is determined to fall on an obstacle location or inside the danger area, a collision is detected. Once the risk of potential collision is detected a proper action is taken to avoid collision. The flowchart shows a secure position selection with diversion algorithm and other feasible solutions that are explained in the next section.

3.2.2 Proposed solutions to avoid collisions

Several solutions are proposed by the KID system to avoid a detected potential collision. Since real-time collision avoidance automatically in conventional system is not possible at the machine level, a secure point is selected offline and the rest of the trajectory is calculated and re-transferred to the CAM machine. In this case, if the secure point strategy does not provide a feasible, safe solution, then other solutions, discussed below, are considered to avoid collisions. The STEP-NC model can give the flexibility to back track the process, easily access all the knowledge in the data-base and modify and improve data/processes and therefore the other solutions can be achieved. The KID system proposes many solutions for collision avoidance, as shown in Fig. 3.

In Fig. 3, a manufacturing chain is shown that represents conventional manufacturing methods based on G-code. Both virtual preparation and real machining scenes are observed using vision sensors. The risk of collision is detected using images and manufacturing information. Once a collision is detected, the following solutions are used for the avoidance:

- *Call CAPP for changing macro process plan (Fourth priority)*
 - Modification into the CAPP file for operation change, number or type of machines used, as per the details explained with an example in Section 4.
- *Call CAM for process change (Third priority)*
 - This CAM process planning change may include changing the process itself. Using another type of process to do the same job on-hand as also explained later in Section 4.

- *Call CAM for changing micro process planning (Second priority)*
 - This micro process planning includes changing the strategy of operations, or operation sequence or synchronization time if multiple tools are working in the same scene, as explained later in Section 4.
- *Call Diversion strategy Algorithm (First priority)*
 - The advanced version of safe path generation algorithm based on Snakes and Ladders Analogy for Production Trajectory (SLAPT) [2] is used to calculate and select a feasible secure position once a collision is detected.
 - Tool is diverted to this secure position and trajectory is re-calculated onwards.

The four solutions proposed above are selected according to the priorities specified. These priorities are defined pursuant to the work and time feasibility of each solution. For example, when a collision is detected, the first priority is to divert the original path, change the tool to another location and continue working. This will help in making the process faster for collision avoidance and production can continue after minor corrections to the previous trajectories. In this case, if priority 1 is not feasible for any reason, e.g., occlusion in the scene, the strategy/sequencing of operation is changed or tool synchronization time is changed. When priority 2 does not provide a feasible solution, the KID system proposes that the operator change the process and switch to other strategy (priority 3) or change the operation, or number/type of machines used (priority 4). In the current state, the KID system generates solutions using the knowledge base and system priorities and asks the operator to change the process plan accordingly. In future work,

Fig. 3 Possible KID system solutions for collision avoidance

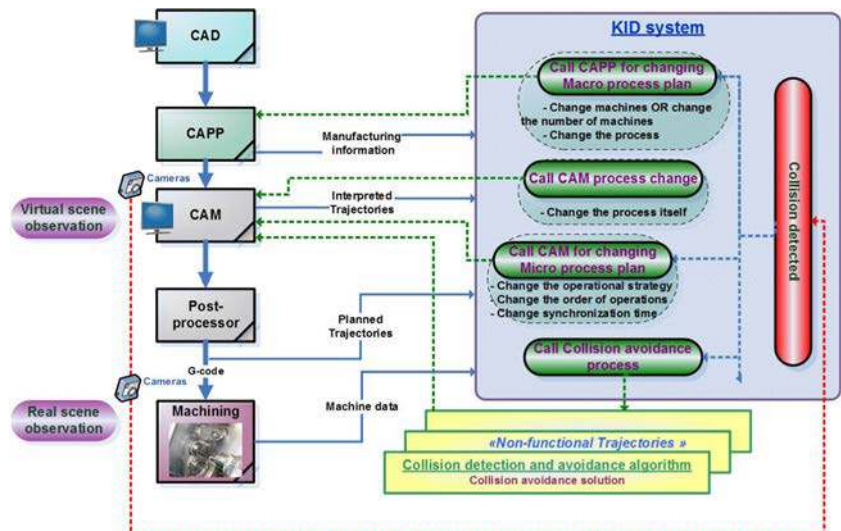

the KID system will provide specific information on when and how to change the process plan between these different priorities.

3.2.3 Diversion strategy algorithm

Once a collision is detected, using pixel information from the updated images of the scene, a secure point is selected to divert the tool. In order to select a secure point, the diversion strategy algorithm generates some secure points in the space above the gross workpiece having a pixel value equal to 0. A secure point is selected using the distance criteria. The secure point is selected, and the onward trajectory is recalculated unless the final point for the next production point is reached.

One solution is selected according to the scenario at hand from amongst all the given solutions for a specific collision avoidance problem. The diversion strategy is first priority as it could be an easy solution to stay in the same parameters of the processing and only modifying the trajectory. If the obstacle is permanent (e.g., a support needed for future processes) and if the same operations are repeated, then the trajectory solution obtained above could be saved to the knowledge base or STEP-NC model for the future processes.

4 KIDs application examples

In the case of collisions, several solutions are suggested by the KID system. For example, a change in operation strategy or process or process planning. The conventional method does not provide the possibility of transferring these changes automatically but the STEP-NC model has the flexibility of changing this by modifying the STEP-NC file. Let us take the example of a workpiece that needs to be manufactured and explain all three changes that could be made for avoiding the potential collisions.

Operations Strategy change A part can be manufactured by using various strategies. If a certain strategy is unable to work on the shop-floor and needs to be changed, the KID system will propose moving back to the micro-planning process of the CAM process, where the strategy applied to the workpiece can be changed while using the same machine-tool. For example, as illustrated in Fig. 4, the turning operation can be performed using different tool approach strategies.

A sequence of operation changes could also be a strategy for change during production. For example, Fig. 5 shows the working-step list and process sequence graph for a workpiece production process [23]. Given the manufacturing features, machining operations and their process sequence

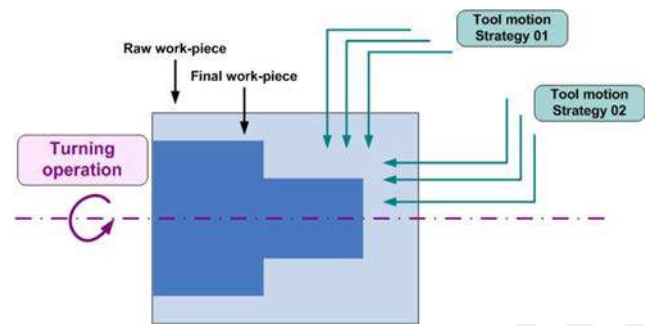

Fig. 4 Example: strategy change

graph, the manufacturing part can be machined in a number of different ways such as: 1-8-2-7-3-4, 1-3-4-2-6-5-7, or 1-3-4-2-5-6-7. These sequences can be alternately used when any problem such as collision is expected during one of the sequences programmed on the shop-floor.

Process change A process change for the same machine-tool is realized if the above changes are unable to avoid collisions in certain production scenarios. Conventional manufacturing practices do not permit the process change but they could be easily obtained in the STEP-NC model. This process change also occurs at the micro-planning level where the CAM process can be called upon for assistance and modifications. If an ongoing process is determined to be unsuitable for a manufacturing operation then this process can be changed. For example, in Fig. 6, the same part can be produced by either a turning or milling process on the same machine-tool (Mill-Turn). The ISO standard

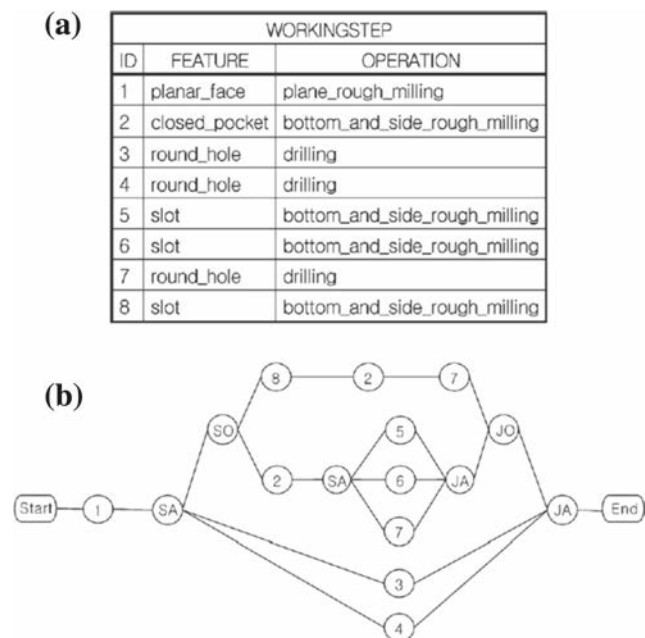
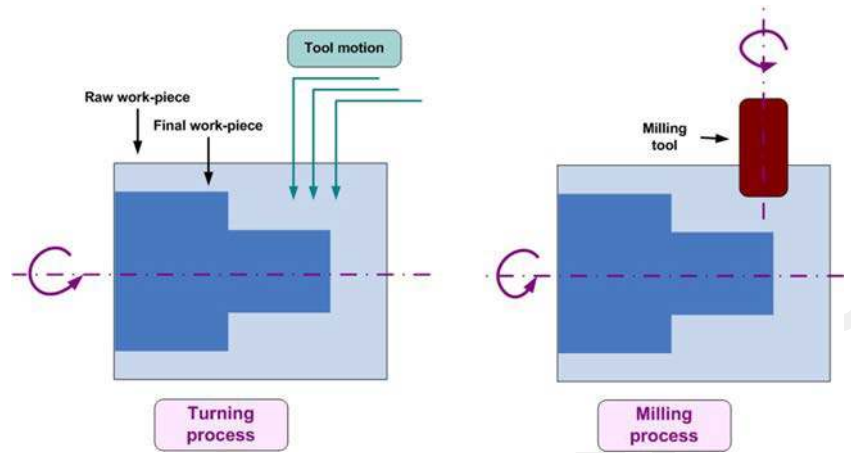

Fig. 5 a Working-steps list. b Process sequence graph [23]

Fig. 6 Example: process change
(Turning or Milling process)



addressed for process change is the STEP-NC data model would be addressed in [26].

Process planning change The process planning change, unlike the other changes discussed above, is macro-planning, where the plan change occurs among different processes of the same or different machines. Let us take the example of a part that could be produced on different machines using various setups. In Fig. 7, this part can be produced using two setups on two different turning machines. The current part of the operation is visible at each setup, the supporting planes are used to support the work-piece during production. Hence, changing the number or type of machines for a certain process is the process-change, above the machine level, that could be achieved easily in the STEP-NC environment because of the communication feedback loop. The same part can be produced using a Mill-Turn machine-tool as shown in Fig. 8, where one setup can finish the job required. Two spindles will do the turning process either simultaneously or one-by-one. From this example, we can see that a single part can be produced with a different process plan. STEP-NC can provide the possibility of changing this process plan while addressing the

STEP standard [25] at the higher level and therefore calling the CAPP process. STEP-NC provides this opportunity by enhancing the communication process between the shop-floor and CAPP processes for any change required in the process plan.

5 Validation of KID approach

When there is a problem on the shop-floor, such as when a collision is detected by the KIDs, the system can propose many solutions for its avoidance. It can command directly the CAM process for change in the sequence of operation, change in operations strategy, change of the time of synchronization, or change of the process itself. The system can also call CAPP processes for process plan change, i.e., using another type of machine-tool or changing the number of machines. These solutions can be implemented automatically in the STEP-NC environment because it can provide easy communication and data/process can be changed/adapted according to necessity, which is not the case in conventional machining. The KID system can also use diversion strategy algorithms (developed in Matlab) to

Fig. 7 Example: process plan 01 (Turning at two different machines 01 or 02)

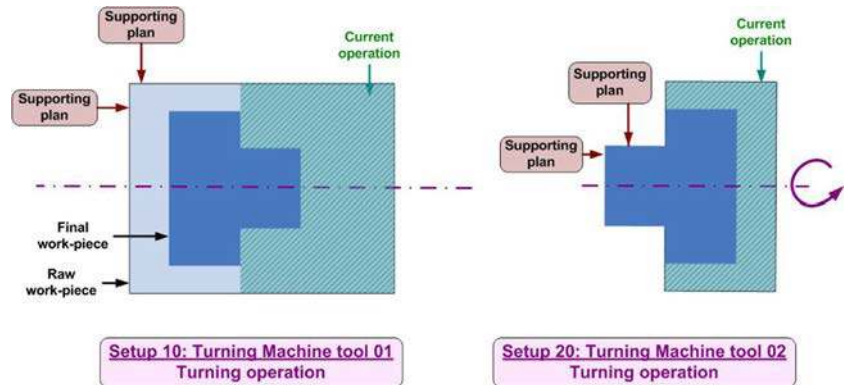
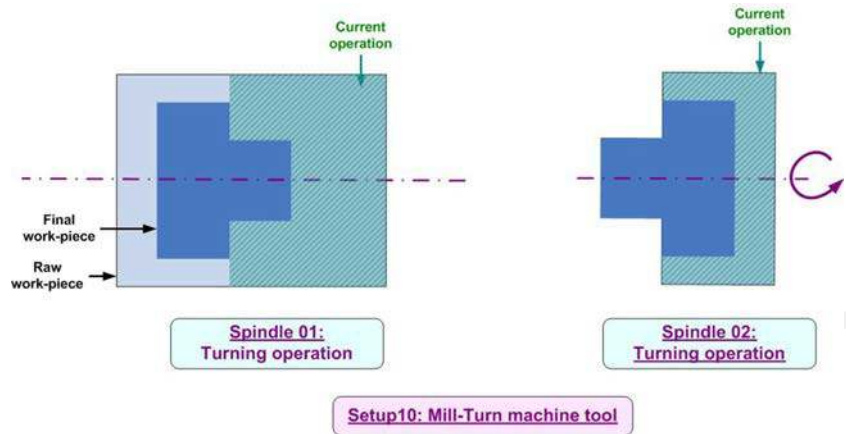

Fig. 8 Example: process plan 02 (Both processes at the same machine)



provide secure positions for the production tool and update the real status of the workpiece in the STEP-NC data model during production. The results of the last solution are validated next while all other solutions will be implemented later in the STEP-NC model.

Validation scenario A multi-axis virtual machine as shown in Fig. 9 has been selected to apply the vision-based KID system solution for safe trajectory generation during CAM simulation. Improper tool synchronization can cause collisions with the unfinished part of the workpiece, which needs to be avoided.

A multi-axis machining scenario has been selected to check the limitations of CAM software (TopSolid/CAM) in the case of multi-tool synchronization in terms of collision detection and avoidance, as shown in Fig. 10. This scenario shows the possibility of collision in a multi-axis machining environment and, at the same time, the problem of multi-tool synchronization and the lack of intelligence for automatic collision detection and avoidance in conventional CAM software.

Different conditions for the scenario treated:

- Multi-axis machine trajectories
- Two tools working on the same workpiece

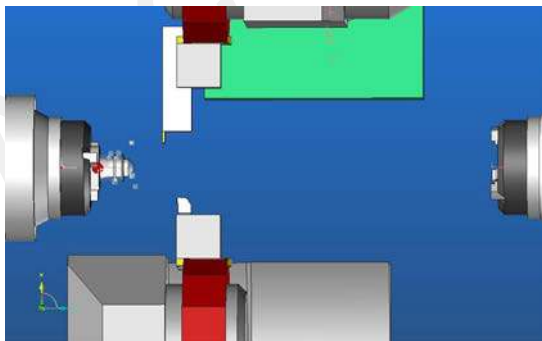

Fig. 9 Multi-axis machine virtual model (Ref: Index G300 (8-axis), 2 spindles and 2 turrets)

- Obstacle is the rotating workpiece unfinished part
- Tools are synchronized to work together
- Tool speed and acceleration issues are not treated in this paper.

In the scenario presented here, two production tools work together to produce the final product.

- When the two tool trajectories are programmed separately and executed separately the production process works well without collisions. However, when production tools synchronization is executed in order to get maximum advantage of the multi-axis, turn-mill machine complexity for efficiency in time, the collision risks increase. Currently, the collision is observed by the vision system, but the CAM software cannot detect it. This is because the current CAM software does not update itself to the changing environment. In particular, it does not update with regard to workpiece changes during the multi-tool synchronization process. In other words, CAM software products are unable to detect the net workpiece left at a certain time during production process synchronization. The CAM software can update the workpiece during production when one

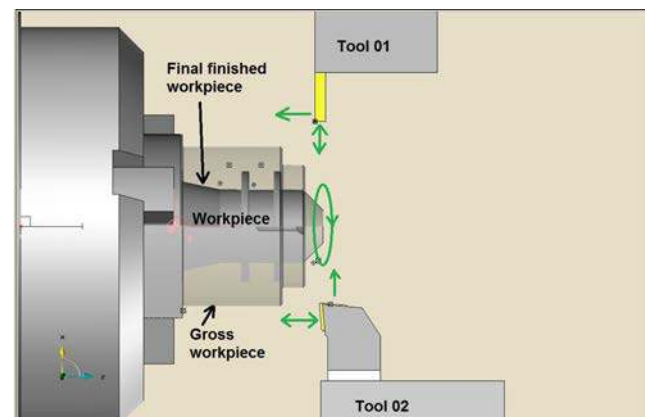

Fig. 10 Multi-axis machining scenario, two tool synchronization

production tool is working. But when multiple tools are synchronized, then the software lacks the intelligence to coordinate them and a collision may occur with the un-finished blank part of the workpiece.

- The problem is explained in Fig. 11 where Tool 01 is machining circular grooves, while Tool 02 is doing the major material removal from the outer surface of the workpiece by roughing and finishing operations. The synchronization graph on the upper part of Fig. 11 clearly shows that the CAM software starts both machining processes at the same time if no human intervention is there. When such parallel operations are programmed, it reduces the production time and hence the gain in time will increase the overall production.

Therefore, Tool 01 will collide with the un-finished part (raw) of the workpiece as detailed in Fig. 12. This collision can be avoided manually using the CAM operator's experience, by programming and synchronizing both tools such that the tools do not have to encounter the problem of collision with the un-finished blank part of workpiece during the manufacturing process. A manually synchronized solution for the same scenario is given in Fig. 13 that clearly shows the synchronization graph where Tool 01 is synchronized after 3 min of the processing done by Tool 02. This is a manual solution provided by an operator for the same problematic.

Multi-tool automatic synchronization is important because it can reduce the time of production. An overview of the time taken for overall workpiece production for the example treated is shown in Table 1. This figure shows the time taken to do both operations, the time taken with automatic synchronization with collision, which is not detected by the CAM software and time taken after manual synchronization. The manual synchronization time does not include the

Fig. 11 Automatic trajectory synchronization by CAM software causing collisions

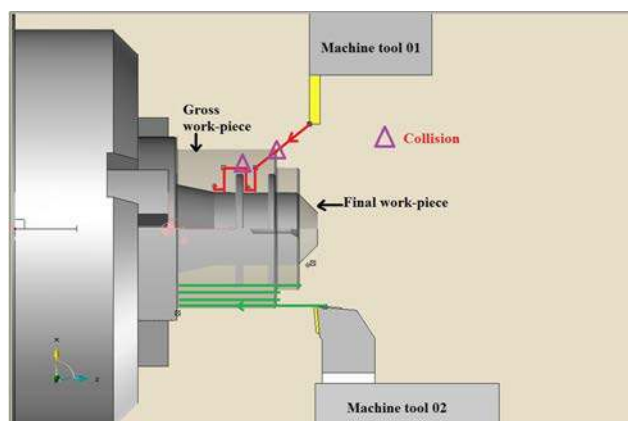
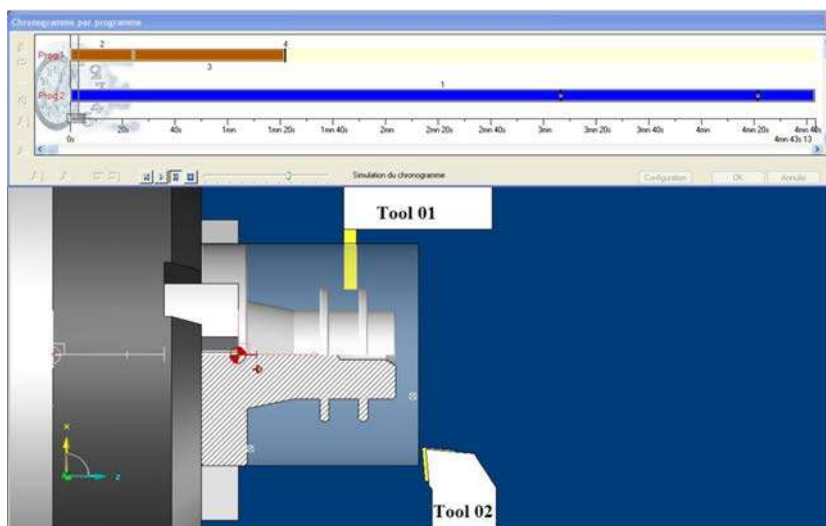

Fig. 12 Collision scenario during two production tools trajectories synchronization for Index G300 (8-axis) machine

CAM operator intervention time, which should be added as well.

The unfinished part of the workpiece that is involved in the collision is more clearly demonstrated in Fig. 14. Here, the production Tool 01 follows the machine strategy to pass from one circular groove to another for the next working-step. The collision occurs because the software only calculates the non-functional trajectory between the two circular grooves using the final finished product during synchronization processes and therefore cannot see the un-finished material left at the production spots.

The novelty of our approach is that it uses information about the trajectory generation strategy (i.e., straight line strategy) and process knowledge and therefore detects the potential collision and avoids it automatically for multi-tool synchronization problem. The proposed vision-assisted KID system will detect the real status of the workpiece at an exact time and, in the case of collision, proper action will be taken to include a detour in the programmed trajectory.

Fig. 13 Manual trajectory synchronization by operator for safe trajectory generation

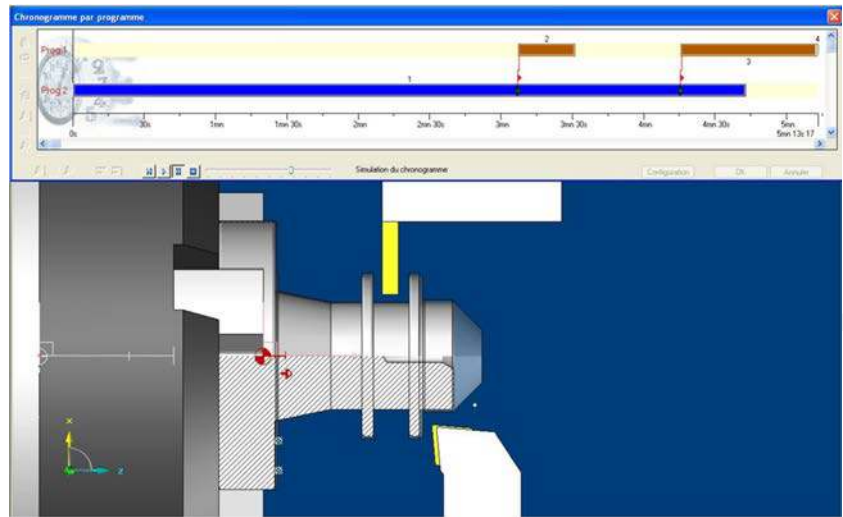

Solution proposed The diversion strategy algorithm presented in Section 3.2 is applied to the scenario and the resulting safe trajectory (without collision) is shown in Fig. 15. The figure shows two types of trajectory before and after the application of the KID system. ‘Trajectory with collision’ is the trajectory generated by the CAM software when both synchronized tools work together. The software is unable to detect the material left during the non-functional trajectory in between the two functional working-steps for machining of the circular grooves. The proposed system takes the image of the scene and detects the material left and ultimately defines the safe trajectory by avoiding collision automatically and intelligently using the procedure defined previously. The safe trajectory, ‘Trajectory without collision,’ is generated by the approach and fed back into the CAM system. The solution obtained is not applied back to the STEP-NC environment but a futuristic way is shown in which this solution could be obtained and will be applied back into the STEP-NC-based machining process.

The solution generated above is one of the solutions proposed by the KID system for safe trajectory generation. All other solutions presented previously could also be implemented as discussed.

Table 1 Production time comparison

Operations	Time taken
Time to do both operations separately	6 min
Time with automatically synchronization of both operations (with collisions)	4 min 40 sec
Manual synchronization	5 min 13 sec

6 Discussion and perspectives

The KID system tool gives many advantages to CAM systems for complex multi-axis machining scenarios:

- It detects collision by capturing the real situation from the scene by using images/videos and knowledge data,
- It proposes safe trajectory solutions by detecting and avoiding collisions automatically and thereby giving more autonomy to the manufacturing process,
- The vision-based KID approach enhances the communication process between different parts of the manufacturing chain especially enhancing the feedback system from manufacturing to CAM system,

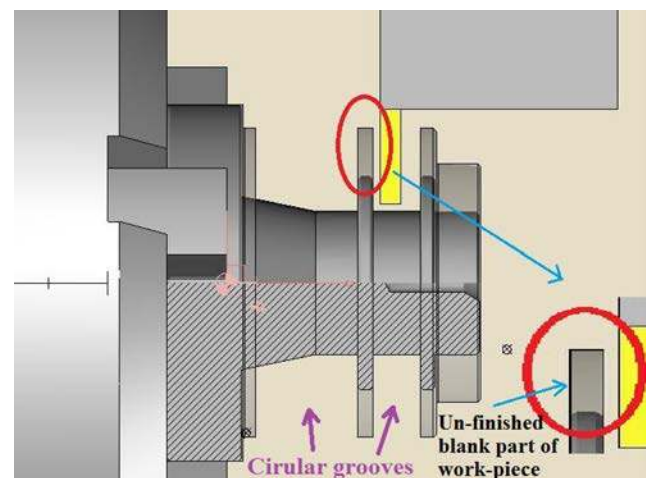

Fig. 14 Collision with the gross material left during production

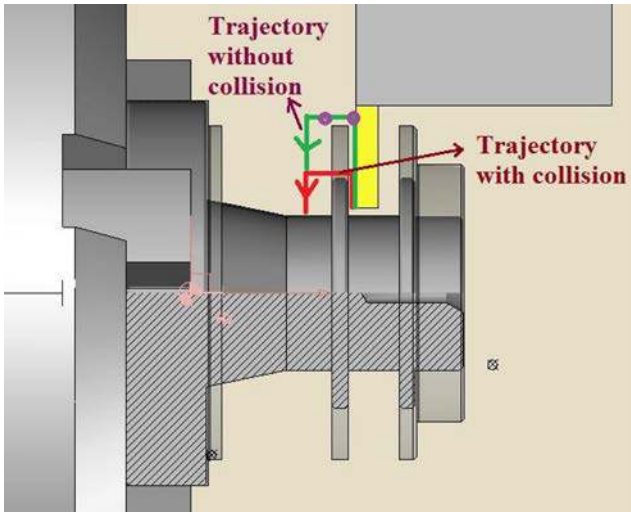

Fig. 15 Results: generated safe trajectory and interpreted trajectory with collision

- The system captures the exact information about the scene from various counterparts of the design and preparation stages,
- As a result of the advantages discussed above, the system increases productivity, autonomy, and intelligence of CAD-CAM and CNC.

Multi-axis and multi-functional NC machining, with the use of G-code, have many limitations currently because of the limited availability of knowledge information, scene complexities, weak communication between different counterparts of the design and production chain and one-way communication from design to production. Besides its complexity, the most important challenge is to make this process more hybrid and intelligent. To communicate between CAD/CAM/CNC systems, the STEP-NC (data model) [9, 24] tries to build a bridge to strengthen the link between different counterparts of the production chain and its basic idea is to make all information/knowledge available at each stage in the design and production chain.

The advantage of the KID system in STEP-NC context is that the regeneration of trajectories can be done automatically from real machining to CAM system; therefore, change of machine for avoiding collision can be done easily when a collision is detected and the diversion algorithm cannot solve the problem. Similarly, when two-tool synchronization can lead to a collision problem, the two operations could be transferred to different machines and the process can be done online by updating the STEP-NC file in the CAM systems. Collisions can also be avoided

by changing the sequence of operations, strategy of operations or the operation itself. These solutions will be treated automatically in perspectives.

Currently, industry is not willing to invest in STEP-NC for a complete manufacturing system because G-code-based approaches are very well rooted. Further issues include liability, which does not permit STEP-NC as a complete manufacturing model. However, STEP-NC is useful for the CAM and therefore industries have started accepting it as a way forward in simulation. Therefore, in future, the existing KID will be adapted to automate the process of 'when and how to change the plan.' Future work will also focus on standardizing the knowledge ontologies and enhancing system interoperability.

Comparison of changes for the use of vision-based KID system When using a KID's approach in conventional and STEP-NC environments, the following changes occur.

- **Conventional machining (G-code based):**
 - Necessity to re-define a complete tool-path when collision is detected,
 - Need to restart the preparation process,
 - Post-processing translation required,
 - New NC file needs to be generated.
- **STEP-NC-based machining:**
 - No need to restart the preparation process,
 - Easy to change a machine without any post-processing required,
 - New non-functional intelligent and safe trajectory generated and inserted in the STEP-NC file,
 - No need to re-process the NC file,
 - STEP-NC file can be updated/improved any time.
 - Current industrial adoption of STEP-NC is only in the CAM areas and therefore KID's helps in capturing the real information and providing solution proposals to the CAM simulation process. However, the future demonstration will also cover the real planning and control with the help of KID's and STEP-NC controllers.

The proposed KID system is intelligent enough to take into account the knowledge information from the scene and generate safe processes for the production of a multi-tool production process. The system is able to detect collisions even with the unfinished workpiece part and is able to devise

a strategy for collision avoidance with multiple micro- and macro-level solutions. The implementation of direct collision avoidance is detailed in the results section while other strategies will be automated in future in STEP-NC model applied to CAM systems.

7 Conclusions

A knowledge-based intelligent decision (KID) system for production planning and decision is presented. The KID system detects and avoids collisions for multi-axis multi-tool machines by using knowledge from the vision sensor, manufacturing process, and machining data. The existing practices do not provide solutions for automated collision detection, collision avoidance, or solution proposals to CAM in the case of problems at the machine shop floor. The KID system proposes many solutions to collisions in CAM simulation where a potential collision may be detected. These solutions may include tool diversion to a secure position, process change, strategy change, sequence change and machine change, etc. The system implementation is implemented on a multi-tool synchronization problem scenario where the current CAM systems are unable to propose solutions to avoid collisions with the unfinished part of the workpiece. The futuristic view of integration of KID system is presented into the environment of STEP-NC assisted CAM, which not only proposes safe trajectory solutions by detecting and avoiding collision using algorithms but also proposes many ways to solve the shop-floor problem and enhance data communication from machine to preparation. The proposed solution is currently implemented on a knowledge-based CAM simulation environment. In future KIDs, standardized ontologies, interoperability, and automated planning proposals will be implemented in the STEP-NC CAM environment.

References

- Ahmad R, Plapper P (2015) Generation of safe tool-path for 2.5D milling/drilling machine-tool using 3D ToF sensor. *CIRP J Manuf Sci Technol* 10:84–91
- Ahmad R, Tichadou S, Hascoet JY (2012) New computer vision based snakes and ladders algorithm for the safe trajectory of two axis CNC machines. *CAD Comput Aided Des* 44(5):355–366. doi:10.1016/j.cad.2011.12.008
- Ahmad R, Tichadou S, Hascoet J-Y (2016) Generation of safe and intelligent tool-paths for multi-axis machine-tools in a dynamic 2D virtual environment. *Int J Comput Integr Manuf* 29(9):982–995. doi:10.1080/0951192X.2015.1130258
- Ahmad R, Tichadou S, Hascoet J-Y (2012) 3D safe and intelligent trajectory generation for multi-axis machine tools using machine vision. *Int J Comput Integr Manuf*:1–21. doi:10.1080/0951192X.2012.717720
- Ahmad R, Tichadou S, Hascoet J-Y (2010) Integration of Vision based image processing for multi-axis CNC machine tool safe and efficient trajectory generation and collision avoidance. *J Mach Eng* 10(4)
- Ata AA, Myo TR (2006) Collision-free trajectory planning for manipulators using generalized pattern search. *Int J Simul Model* 5(4):145–154
- Bennewitz M, Burgard W (2000) A probabilistic method for planning collision-free trajectories of multiple mobile robots. In: applications and safety issues in an emerging market. Citeseer
- Danjou C, Le Duigou J, Eynard B (2015) Closed-loop manufacturing process based on STEP-NC. *Int J Interact Des Manuf*:1955–2513. doi:10.1007/s12008-015-0268-1
- Hascoet JY, Rauch M, Suh SH (2007) Relevance of Step-Nc standard for high level toolpaths generation. In: *Int. conf. on high speed milling*. San Sebastian (Spain)
- Hascoet J-Y, Bennis F, Guerin F (1993) Optimization of tool trajectory for five axis control Machining. *Int Conf Iasted Robot Manuf*:120–122
- Jime P, Thomas F, Torras C (2001) 3D collision detection: a survey. *Comput Graph* 25:269–285
- Jun C, Cha K, Lee YS (2003) Optimizing tool orientations for 5-axis machining by configuration-space search method. *Comput Aided Des* 35(6):549–566. doi:10.1016/S0010-4485(02)00077-5
- Lee S, Kardaras G (1997) Elastic string based global path planning using neural networks. *IEEE*:108–114. doi:10.1109/CIRA.1997.613846
- Moravec H, Elfes A (1985) High resolution maps from wide angle sonar. *Proc IEEE Int Conf Robot Autom* 2:116–121. doi:10.1109/ROBOT.1985.1087316
- Morishige K, Kase K, Takeuchi Y (1997) Collision-free tool path generation using 2-dimensional C-space for 5-axis control machining. *Int J Adv Manuf Technol* 13:393–400
- Moriwaki T (2008) Multi-functional machine tool. *CIRP Ann Manuf Technol* 57(2):736–749. doi:10.1016/j.cirp.2008.09.004
- Petiot J-F, Chedmail P, Hascoet J-Y (1998) Contribution to the scheduling of trajectories in robotics. *Robot Comput Integr Manuf* 14:237–251. doi:10.1016/S0736-5845(97)00032-X
- Rauch M, Xu X (2010) Five-axis machining: technologies and challenges. *Int J Manuf Res*:327–352
- Schumann M, Witt M, Klimant P (2016) A real-time collision prevention system for machine tools. *Procedia CIRP*, Elsevier B.V. 7:329–334. doi:10.1016/j.procir.2013.05.056
- Tang TD (2014) Algorithms for collision detection and avoidance for five-axis NC machining: a state of the art review. *Comput-Aided Des* 51:1–17. doi:10.1016/j.cad.2014.02.001
- Wang Q-H, Li J-R, Zhou R-R (2006) Graphics-assisted approach to rapid collision detection for multi-axis machining. *Int J Adv Manuf Technol* 30(9):853–863. doi:10.1007/s00170-005-0127-5
- Xu X, Newman S-T (2006) Making CNC machine tools more open, interoperable and intelligent—a review of the technologies. *Comput Indus* 57(2):141–152. doi:10.1016/j.compind.2005.06.002
- Xu X-W, Wang H, Mao J, Newman S-T, Kramer T-R, Proctor F-M, Michaloski J-L (2005) STEP-compliant NC research: the search for intelligent CAD/CAPP/CAM/CNC integration. *Int J Prod Res* 43(17):3703–3743
- Yang W, Xu X (2008) Modelling machine tool data in support of STEP-NC based manufacturing. *Int J Comput Integr Manuf* 21(7):745–763. doi:10.1080/09511920701810691
- ISO10303-238.,2007. ISO 10303-AP238, Industrial automation systems and integration, Product data representation and exchange, Part 238: application protocol: application interpreted model for computerized numerical controllers, TC 184/SC 4, International Organization for Standardization

26. ISO14649-1, 2003. ISO 14649 Part 1 : Industrial automation systems and integration, Physical device control, Data model for computerized numerical controllers Part 1: overview and fundamental principles, TC 184/SC 1, International Organization for Standardization
27. ISO14649 Part 10 - Industrial automation systems and integration - physical device control - data model for computerized numerical controllers - Part 10: general process data, ISO TC 184/SC1, 2004, International Organization for Standardization
28. ISO14649 Part 11 - Industrial automation systems and integration – Physical device control – Data model for computerized numerical controllers – Part 11: Process data for milling, TC 184/SC 1, 2004, International Organization for Standardization
29. ISO14649 Part 12 - Industrial automation systems and integration – Physical device control – Data model for computerized numerical controllers – Part 12: Process data for turning, TC 184/SC 1, 2005, International Organization for Standardization

Accepted Manuscript