



**HAL**  
open science

## Ultra Low-Power Acoustic Wake-Up System Based on Frequency Detection

Manon Fourniol, Valentin Gies, Valentin Barchasz, Edith Kussener, Herve Barthelemy, Remy Vauche, Hervé Glotin

► **To cite this version:**

Manon Fourniol, Valentin Gies, Valentin Barchasz, Edith Kussener, Herve Barthelemy, et al.. Ultra Low-Power Acoustic Wake-Up System Based on Frequency Detection. 2018 IEEE International Conference on Internet of Things and Intelligence System (IOTAIS), Nov 2018, Bali, Indonesia. pp.109-115, 10.1109/IOTAIS.2018.8600849 . hal-02022330v1

**HAL Id: hal-02022330**

**<https://hal.science/hal-02022330v1>**

Submitted on 26 Dec 2021 (v1), last revised 6 Jan 2022 (v2)

**HAL** is a multi-disciplinary open access archive for the deposit and dissemination of scientific research documents, whether they are published or not. The documents may come from teaching and research institutions in France or abroad, or from public or private research centers.

L'archive ouverte pluridisciplinaire **HAL**, est destinée au dépôt et à la diffusion de documents scientifiques de niveau recherche, publiés ou non, émanant des établissements d'enseignement et de recherche français ou étrangers, des laboratoires publics ou privés.

# Ultra Low-Power Analog Wake-Up System based on Frequency Analysis

Manon Fourniol<sup>†‡</sup>, Valentin Gies<sup>†‡</sup>, Valentin Barchasz<sup>‡</sup>, Edith Kussener<sup>†</sup>,  
Hervé Barthelemy<sup>†</sup>, Remy Vauché<sup>†</sup> and Hervé Glotin<sup>§</sup>

<sup>†</sup>Aix Marseille Université, Université de Toulon, ISEN, CNRS, IM2NP - UMR 7334, 13397 Marseille, France

<sup>§</sup>Aix Marseille Université, Université de Toulon, CNRS, LSIS - UMR 7296, 83000 Toulon, France

<sup>‡</sup>Université de Toulon, SMIoT, 83000 Toulon, France

**Abstract**—An ultra low power wake-up detector based on frequency analysis is presented in this paper. Focused on environmental or military Internet of Things (IoT) applications, it aims at detecting in real time the presence of specific animal species or drones for generating alerts and for triggering power consuming tasks such as high frequency signal recording only when needed.

This wake-up detector continuously monitors the presence of specific frequencies in an analog signal, with a good frequency selectivity and a high frequency detection capability. It is based on an ultra-low analog frequency to voltage converter using a current-mirror, analog timers and comparators.

Dedicated to long term stealth environmental or military surveys, a strong emphasis has been put in power consumption reduction in order to limit size and weight of the system. This power consumption has been reduced to  $34\mu W$ , leading to a full year of autonomy including the microphone when powered by 3 coin cell CR2032 batteries.

## I. INTRODUCTION

Internet of Things (IoT) systems for environmental and military surveys are submitted to strong operational or environmental constraints, such as installing a device in a strict nature area or in a restricted area. Environmental and military surveys requires to record signals such as sound for long periods of time (several months or years). Long recording operations are hardly compatible with low power and high frequency recording because of data storage capacity or battery energy.

For example, acoustic recording of animals such as bats or rats, having a communication and localization system emitting up to  $120kHz$  [1] and aerial drones producing a characteristic noise around  $40kHz$  [2], requires to have a data acquisition system working at a minimum of  $240ksp/s$  with a resolution of 24 bits for detecting low level signal. This leads to store  $2.5GB$  of data every hour for each channel.

In these conditions, it is almost impossible to have a portable autonomous long term data acquisition system able to record continuously. We have to cope with an issue described in [3]–[6]. In order to store efficiently the high frequency acoustic signals occurring sparsely at a random time, it is more efficient to start recording only when an interesting signal is present. This allows to avoid useless power consumption, useless data storage saturation, and useless post-processing for rising alarms or finding out interesting events. Following the emerging idea of using edge computing techniques, this local

pre-filtering process allows to detect only interesting events, thus consuming less, saving a huge amount of data storage and making the recorder operational for a longer time.

Existing state of art environmental recording systems [7] [8] are working on a standard  $12V - 1.2Ah$  lead battery having a global capacity of  $14.4Wh$ . In continuous high frequency recording, batteries would last only 30 hours, without including the energy necessary for processing signals and generating alerts. Fortunately, continuous recording is mostly not necessary for environmental rare event detection, but can be reduced to interesting data periods, for example for detecting intrusions of specific species in a strict natural reserve or malicious behaviors such as aerial drones invasions in a restricted military area.

A solution allowing long term monitoring and alert generation is to use a wake-up detector activated by detection of a specific frequency on the acoustic signal, and to record the signal only when the wake-up detector has been triggered. Low power wake-up systems based on raw frequency detection exist [9], like [10] but they are mainly specified on detecting a specific frequency [11] and are specialized in radio frequency analysis, for example RFID technologies [12]. There are also some detectors using advanced digital processing techniques and having more developed capabilities such as pattern detection, like [13] or [14], but with a limited sampling frequency and at a higher overall power cost due to analog to digital conversions.

In [15], we have introduced a way for detecting environmental events using a digital wake-up detector working on high frequency sound signal has been proposed. Power consumption of this system is about  $0.6mW$  and consumption of the ultrasonic microphones used (Knowles SPU0410LR5H) is equivalent. Using a  $14.5Wh$  battery (classical  $12V - 1.2Ah$  lead battery), this micro-controller based wake-up system can be active about 3 years in continuous mode, compared with a 30 hours of continuous high frequency recording with most of the time no useful signal. This is paving the way for long term environmental survey protocols, but with a major drawback : it is impossible to use it in very lightweight and small embedded systems due to the lead battery size which is 10cm long and weights 600g.

In this paper, we present a novel implementation of a high frequency signal wake-up detector based on an analog implementation using discrete components as shown in fig. 1.

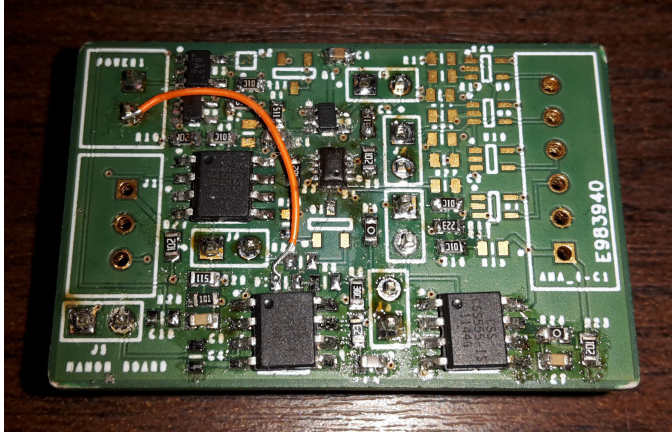

Fig. 1. Ultra-low power analog wake-up detector

First, the general architecture of the acquisition system is presented with a focus on the power consumption budget available in wake-up always on detection mode. In a second part, the ultra-low power analog implementation of the wake-up system based on frequency analysis is described. In a third part, results are presented and compared to existing solutions.

## II. ACOUSTIC ENVIRONMENTAL MONITORING SYSTEM DESCRIPTION

### A. Size and weight reduction : a strong constraint on batteries

As explained in the introduction, compared to previous solutions, we aim at reducing the size and the weight of the data acquisition system to embed it anywhere without disturbing present species.

We mainly focus on the battery size reduction by using standards  $3V - 0.23Ah - 0.69Wh$  CR2032 batteries (weighting 3g each) instead of a classical  $12V - 1.2Ah - 14.4Wh$  lead battery (weighting 600g) as presented in [15]. Battery weight has to be reduced by a factor 100 whereas capacity has to be reduced by a factor 10. At the same time, lifetime of the detection system must be maintained in wake-up always on mode for at least one year. That means power consumption has to be reduced by approximately a factor 10 to compensate the battery reduction.

Considering that alerts to be detected and recorded are rare, we can assume that the maximum acceptable average power consumption in wake-up detection mode is approximately equal to the battery capacity divided by the needed autonomy of the system (i.e. 12 months). It is the same for aerial drones detection systems, considering intrusions are rare. For example, using 3 coin cell batteries CR2032, this leads to allow an average power budget on one year of  $\frac{3 * 0.69}{24 * 365} = 236\mu W$  for the always on wake-up detection mode including the microphone power supply. With this

constraint, use of the Knowles *SPU0410LR5H* microphone used in [15] is not possible because its power consumption is  $500\mu W$ . Instead, we have chosen another lower power microphone from Knowles, the *FG-23329-P07* having a power consumption of about  $200\mu W$ . This microphone has been validated experimentally for ultrasonic detection at  $40kHz$  or more without any trouble, even if it is not described in the corresponding Knowles datasheet. With this microphone,  $36\mu A$  are available for powering the wake-up always on detector.

### B. System architecture

This paper focuses on the low power wake-up system based on frequency analysis, however a global description of the recording and analysis system is presented in Fig. 2. The acoustic low power wake-up system based on frequency analysis is connected with other parts of the high frequency recording system using a low power device. Processing is done in three steps, each one having an increasing power cost :

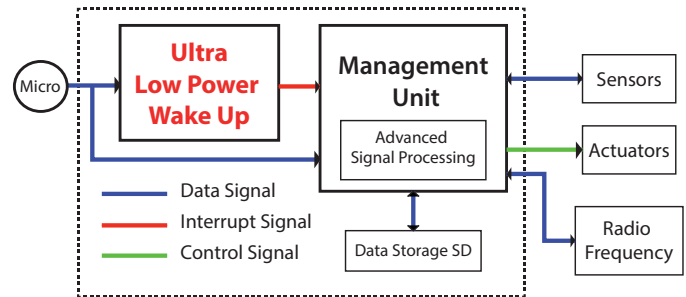

Fig. 2. Global recording system description.

- First, a microphone transmits input signal to our low power analog implementation of the wake up device based on frequency analysis. When the wake up system detects a specific frequency sound distinctive of an animal, an interrupt is sent to the management system.
- Upon reception of an interrupt, the management unit microcontroller starts further advanced signal processing using traditional linear or non-linear filters, neural networks, wavelets transforms or correlations to determine whether the signal detected is a true alert or not [16]–[20]. Other additional sensors can be used for improving the quality of these additional computations. These operations are performed on demand, with a more important power consumption of about  $17.5mW$ . The management unit is also able to launch an alert. It is interesting to notice that, depending on the signal interest, our ultra low power wake-up system based on frequency analysis could be sufficient, as the high frequency (from 40 kHz to 200 kHz) will be far away from the human activities frequency range. These filtering operations are not in the scope of this paper.
- Then, if the detection is confirmed, the management unit starts recording the signal from the microphone and stores

it on a SD card for a defined amount of time, in order to record the next occurrences of the interesting signal. It is important to notice that this way of proceeding cannot be used for recording one shot signals because signal used for low power acoustic wake-up is lost. A solution using an analogical to digital signal buffer converter could be implemented but would not be low power.

### III. ULTRA LOW-POWER WAKE-UP DETECTOR BASED ON FREQUENCY ANALYSIS ANALOG IMPLEMENTATION

This paper is focused on the analog low power wake-up detector. It has been designed with an idea of simplicity in order to get the lowest power consumption possible. It is based on a frequency to voltage conversion, using a monostable driven linear discharge of a capacitor at a constant current. Periodically, the voltage of the capacitor, image of the input frequency, is sampled and hold for being compared to thresholds by analog comparators.

This implementation has been inspired by our previous digital implementation on a PIC24FJ256 [15], [21] from Microchip, but with a drastic reduction of power consumption.

#### A. Architecture Description

As shown on fig. 3, signal from the analog low power microphone is first passed into an hysteresis comparator. This comparator allow to remove ambient noise by triggering only when a the  $U_S$  input signal have a sufficient amplitude.

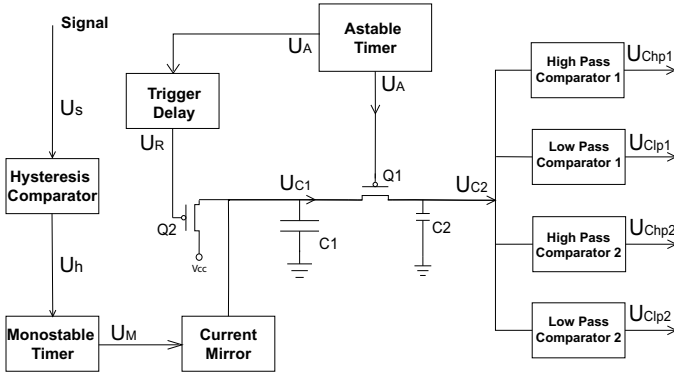

Fig. 3. Ultra Low Power Acoustic Wake-Up System

Then, output  $U_h$  of the hysteresis comparator enters a monostable analog timer which will generate pulses  $U_M$  with a constant high time, but synchronized with the input signal. At this step, we can notice that  $U_M$  average value is directly proportional to input signal  $U_S$  frequency. At this step, a simple  $RC$  filter could be used, but the frequency to voltage conversion would not be linear due to the exponential charges of the  $RC$  filter. Instead of that, we need a perfectly linear conversion in order to determine accurately the input frequency.

This linear conversion is done using a current mirror coupled to a capacitor  $C_1$ . This has been inspired by our preceding implementation as shown in [15]. The current mirror is used like the Charge Time Measurement Unit (CTMU) from a

PIC24F of Microchip [22]. Pulses from the monostable Timer are creating a constant current in the left transistor of the current mirror, this constant current is mirrored to get  $I_{C1}$  and used to discharge the capacitor  $C_1$ . Thus, voltage  $U_{C1}$  decrease linearly during the monostable pulses, and remains constant during the other phases.

Equation 2 describes  $U_{C1}$  evolution, corresponding to waveforms presented at fig. 4 :

$$\begin{aligned} U_{C1} &= V_{CC} - \int_0^t \frac{I_{C1}(t)}{C_1} dt = V_{CC} - \int_0^t \frac{I_0}{C_1} U_m(t) dt \\ &= V_{CC} - \frac{I_0}{C_1} * N * T_{PW} \end{aligned} \quad (1)$$

$$= V_{CC} - \frac{I_0}{C_1} * \frac{F_S}{F_{SH}} * T_{PW} \quad (2)$$

where  $U_m$  is a logical level 1 or 0 depending on the monostable output state,  $I_0$  is the current during monostable pulses in the current mirror,  $T_{PW}$  the pulses duration,  $N$  the number of pulses between two successive resets,  $F_{SH}$  the sample and hold frequency, and  $F_S$  is the input signal frequency.

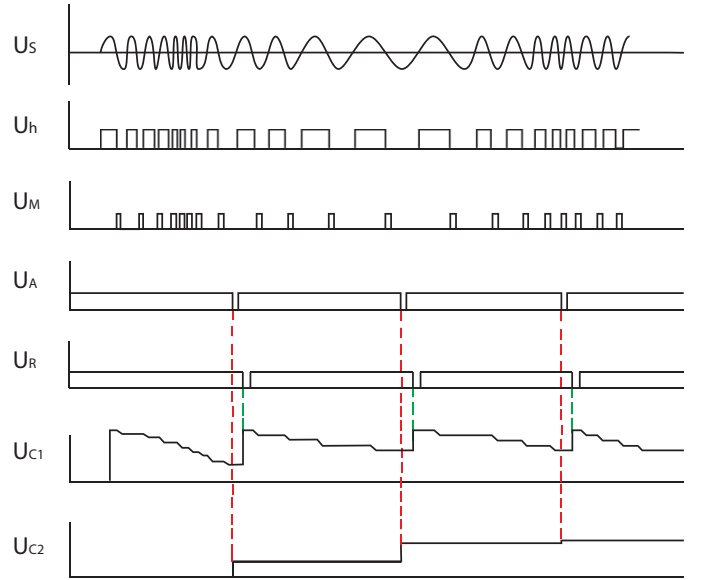

Fig. 4. Analog Wake-up detector waveforms

$U_{C1}$  voltage is an image of the frequency and have to be read periodically. This is done using a low frequency astable timer producing periodically a signal  $U_A$  at a fixed frequency  $F_{SH}$ , for closing  $Q_1$  PMOS transistor.  $U_{C1}$  voltage is sample and hold into  $U_{C2}$ , considering that  $C_1$  capacitor value is much more important than  $C_2$  capacitor value. While this sample and hold operation has been done,  $Q_1$  transistor is opened and  $Q_2$  PMOS transistor is closed in order the reset the voltage  $U_{C1}$  value at  $V_{CC}$ .

Consequently,  $U_{C2}$  voltage is an image of the input signal frequency. Final step of the process is to compare it with fixed values in order to determine if the measured frequency is within or not a specified interval. An ADC could also be used

to get the frequency value, but it would lead to a tremendous power consumption compared with the overall consumption of our wake-up trigger.

### B. Implementation

Implementation of this ultra low-power wake-up detector has been done on a PCB board using ultra low power analog components. For example, 3.3V reference voltage is done using a ultra low power regulator TPS783 [23] that regulates the input voltage to 3.3V while consuming only 500nA.

1) *Input Comparators*: The input signal  $U_S$  is first processed by a hysteresis trigger as shown in fig. 3. The hysteresis comparator outputs the  $U_h$  signal. A small ambient noise will not trigger the hysteresis comparator, thus eliminating the input low level perturbations. Compared to the single comparators used in [15], the hysteresis comparator offers a more reliable noise rejection. In order to adapt filtering to the different detection sensitivity, hysteresis level can be adjusted by a reference voltage generated by the DAC of the supervisor.

Choice for the comparator is important because of the trade-off between operating frequency and power consumption. *TVL3691* [24] is a good candidate with its very low power consumption (only 75nA). However its maximum computing signal frequency (30 kHz) is too low for high frequency operations such as bats detection. Another reference has been chosen : *TLV7031* [25] from Texas Instrument having a propagation delay comprised between 3  $\mu$ s and a supply current of 335nA. It allows to process signal up to 300 kHz.

2) *Timers*: Ultra low power timers are a key of our analog wake-up detector. They are used for generating monostable pulses synchronized with the rising edges of the input signal, for generating an astable sample and hold signal ( $U_A$ ) and a delayed signal ( $U_R$ ) for resetting capacitor voltage after a sample and hold operation. This requires the use of three timers. Due to power constraints, a very low implementation of the classical 555 timer has been chosen : the *CSS555C* [26] consuming 3 $\mu$ A only and having a large field of applications [27].

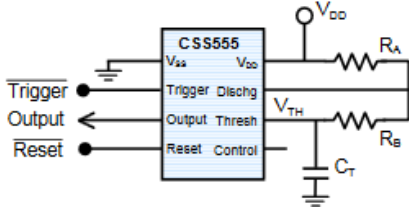

Fig. 5. Monostable Timer.

Signal  $U_h$  from the input comparators triggers a monostable timer, producing a rising edge  $U_M$  on each falling edge of the input signal. Fig. 5, shows the hardware implementation using *CSS555*. Pulse width  $T_{PW}$  is obtained from equation 3 :

$$T_{PW} = L(R_A + 2R_B)C_T \quad (3)$$

where  $L = 0.695$  is a constant corresponding to a production parameter. In order to process input signals at 100kHz,  $T_{PW}$  has been chosen equal to 0.66 $\mu$ s, leading to  $R_A = 10\Omega$ ,  $R_B = 0\Omega$  and  $C_T = 100pF$ . Having a lower capacitor has been tested, but the behavior has been unstable, due to parasitic capacitors not negligible under these values.

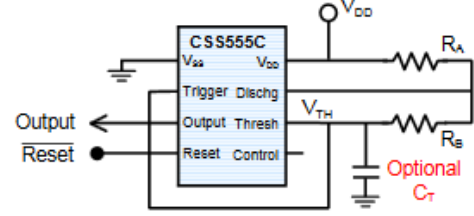

Fig. 6. Astable Timer.

Astable signal is also generated by a *CSS555* timer producing a periodic signal  $U_A$  as shown in fig.6. Astable frequency is set using equation 4:

$$T_{OSC} = L(R_A + 2R_B)C_T \quad (4)$$

Where  $L = 0,695$  is still a constant. In order to obtain an sample and hold frequency of about 1kHz,  $R_A = 700k\Omega$ ,  $R_B = 370k\Omega$  and  $C_T = 1nF$  have been chosen.

The capacitor reset signal  $U_R$  is obtained for  $U_A$  by adding a delay using a *CSS555* as shown in fig.7. Delay is set using equation 7:

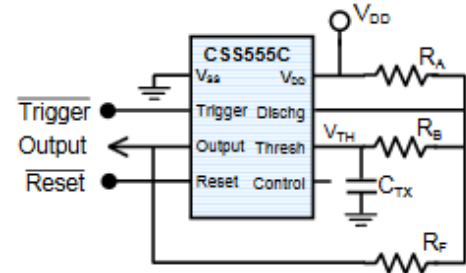

Fig. 7. Delay Timer.

$$t_{d0} = \ln\left(\frac{2}{3}\right) - \ln\left(1 - \frac{2}{3}(R_F + R_A)/R_F\right) \quad (5)$$

$$t_{d1} = \ln\left(\frac{2}{3}\right) - \ln\left(\frac{1}{3}\right) = 0,693 \quad (6)$$

$$t_D = \frac{1}{2}C_T [t_{d0}(R_A//R_F + R_B) + (t_{d1}R_B)] \quad (7)$$

$$t_{PW} = \frac{1}{2}C_T t_{d1}(R_A//R_F + 2R_B) \quad (8)$$

Where  $t_D$  is the delay and  $t_{PW}$  the pulse width. In order to have a delay of 20 $\mu$ s allowing to correctly transfer charges from  $C_1$  to  $C_2$  before reset, following values have been chosen :  $R_A = 100k\Omega$ ,  $R_B = 10k\Omega$ ,  $R_F = 510k\Omega$  and  $C_T = 100pF$ .

3) *Current Mirror*: Current mirror is the last central element of our system. It is replacing the CTMU [22], [28], [29] used in [15]. The current mirror is used as a constant controlled current source driven by the monostable output  $U_M$  for discharging main capacitor  $C_1$ . When activated, current value in the mirror  $I_0$  is set by the serial resistor and the output voltage of the monostable as shown in equation 9.

$$I_0 = \frac{V_{CC} - V_{BE}}{R} \quad (9)$$

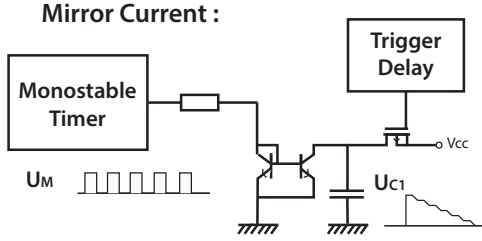

Fig. 8. Current Mirror

Choice of the current mirror analog component is very important as precision of frequency measurement relies directly on the mirror precision. BCV62 PNP current mirror [30] has been tested at a first time because of its low cost. But its precision was too low (70% of matching between transistor T1 and transistor T2) for a precise detection of frequency. Then, REF200 [31] from Texas Instrument has been chosen. This expensive current mirror is very precise, with around 0.25% of matching between the two transistors. It works up to 5MHz which is more than sufficient for our 100kHz signal. Power consumption is not a problem for the mirror considering it is only consuming power when monostable is triggered, that means rarely. The choice of the REF200 has an impact on the design. It uses NPN transistors, that means current is discharging capacitor  $C_1$ , whereas a PNP mirror could be used for charging the capacitor.

4) *Capacitors and associated currents*: Capacitor  $C_1$  is the heart of the analog wake-up detector, being charged linearly by successive phases. The values of  $C_1$ ,  $C_2$  and  $I_0$  have to be chosen carefully. Considering input frequency to be detected is 100kHz, sample and hold frequency is 1kHz,  $T_{PW} = 0.66\mu s$  and  $U_{C1}$  minimal value is 0, equation 2 gives :

$$\frac{I_0}{C_1} = \frac{V_{CC}}{\frac{F_s}{F_{SH}} * T_{PW}} = 50000 \quad (10)$$

Limiting the mirror current to  $I_0 = 0.1mA$  conducts to have  $C_1 = 200nF$ .

After integration,  $U_{C1}$  voltage have to be sampled and hold in  $C_2$ . This is done by closing  $Q_1$  PMOS. Charges are transferred from the  $C_1$  to  $C_2$ , leading to a change in  $U_{C1}$ . In order to keep this change as low as possible,  $C_2$  value have to be chosen far lower than  $C_1$  and has been set to  $C_2 = 1nF$ .

5) *Output Comparators*: Once the  $U_{C1}$  has been sampled and hold into  $C_2$  capacitor,  $U_{C2}$  has to be exploited in a very efficient and simple way. This is done using ultra low power and low speed comparators as shown in fig.9.

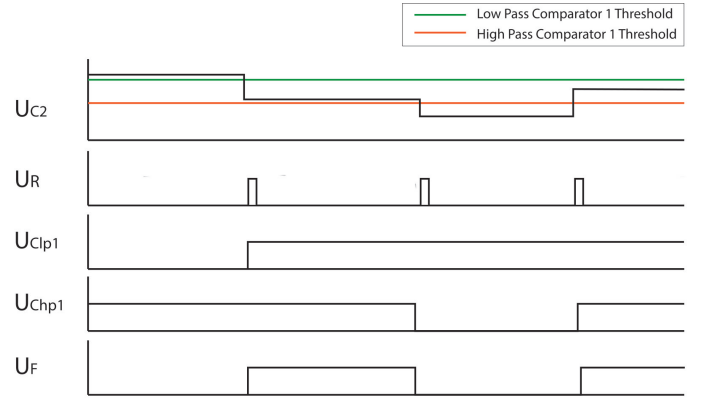

Fig. 9. Final Computation

By associating 2 comparators, a specific range of input frequency can be selected in output with a good precision. If the input signal frequency is in the selected interval, both outputs of the comparators will be equal to a logical 1, triggering an interrupt on the management unit.

Several comparators associations can be done, allowing to detect a signal in several bands of frequencies. This can be used for detecting generated frequencies of order to synchronize or trigger a wireless sensor network as presented in [32].

As the output comparators are working at a low frequency, is not necessary to use a fast comparator such as the TVL7031. Instead of that, the TVL3691 can be used, leading to an additional power reduction.

#### IV. RESULTS

Our ultra-low power wake-up detector has the ability of detecting signals having a frequency up to 300 kHz. As we can see on the figure 3, three comparators TLV7031 are present in the design, each one having a power consumption of  $0.335\mu A$ . Three analog functions using a CSS555C are also used, each one having a power consumption of about  $3\mu A$  under 3.3V, considering the power consumption of the CSS555C itself, which is much more important than the power consumption of the large resistors and capacitors around. Power consumption of the current mirror is very low, because this component is only active on the monostable pulses. This is also true for the resistors around the CSS555C. Both MOS-FET are also used sparsely and thus have a very limited power consumption compared to the CSS555C. Adding all power consumptions, this leads to an approximate overall consumption of  $36\mu W$  for the analog wake-up detector.

This power consumption can be reduced by replacing the TLV7031 by the TLV3691 which consume only  $75nA$  but is limited to 30kHz. This replacement can be done only on the final comparators because they are working at a low frequency (less than 1 KHz). We this replacement, power consumption is reduced to  $34\mu W$ .

This power consumption can be compared with the micro-controller implementation of the acoustic Wake-up detector presented in [15]. This digital wake-up detector makes the

most of the *CTMU* module from a *PIC24F* from MicroChip. Its power consumption is about 0.6 mW.

Finally, our analog wake-up detector power consumption is 18 times lower than this previous implementation. This allows the system to detect wake-up high frequency analog events in continuous mode during 2.3 years on a single CR2032 coin cell having a 230mAh capacity. Used with a low power microphone *FG-23329-P07* from Knowles, the power consumption raises to 230μW, leading to a continuous detection of 125 days using a single CR2032 coin cell. A one year autonomy can be achieved using 3 coin cells, having a total weight of 9 grams. This solution is perfectly suited for long term embedded stealth monitoring systems used in environment or military applications.

## V. CONCLUSION AND FUTURE WORKS

This miniaturized solution can be used in a large common class of environmental or military issues : stealth recording or analyzing of acoustic signals emitted by animals or drones, by prefiltering instants when they are present or suspected to be there. For being stealth, size and weight of the system are very important and are greatly improved by our analog wake-up detector, considering

As an example of use, we use this analog wake-up detector for protecting a strict nature reserve island (Ilot Bagaud, part of the *Parc National de Port Cros* in France) from rats intrusions with the *Qualilife* system [8], [33] integrating the low power acoustic wake-up system shown in Fig. 3.

Other applications using non acoustic high frequency signal analysis and detection can be developed using our analog Wake-up detector. In particular, using photo-transistors instead of microphones allows to have a pulsed light wake-up system operated from a long distance with no propagation delay. This can be used for triggering simultaneously a whole environmental wireless sensor network even in a dense environment. This can be used in cooperation with sound detection for trajectory applications [32].

## ACKNOWLEDGMENT

The authors would like to thank the *Parc National de Port Cros* in France for their cooperation in the development and use of our recording systems and acoustic wake-up systems.

The authors would particularly like to thank the Embedded Electronics Technology Platform of Toulon University named SMIoT (*Scientific Microsystems for Internet of Things*) [34] for its support in the achievement of the project.

## REFERENCES

- [1] J. Whitaker, *National Audubon Society Field Guide to North American Mammals*. National Audubon Society Field Guides, 1996.
- [2] S. R. Ganti and Y. Kim, "Implementation of detection and tracking mechanism for small uas," in *2016 International Conference on Unmanned Aircraft Systems (ICUAS)*, June 2016, pp. 1254–1260.
- [3] B. Gestner, J. Tanner, and D. Anderson, "Glass break detector analog front-end using novel classifier circuit," in *2007 IEEE International Symposium on Circuits and Systems*, May 2007, pp. 3586–3589.
- [4] S. Jeong, Y. Chen, T. Jang, J. Tsai, D. Blaauw, H. S. Kim, and D. Sylvester, "21.6 a 12nw always-on acoustic sensing and object recognition microsystem using frequency-domain feature extraction and svm classification," in *2017 IEEE International Solid-State Circuits Conference (ISSCC)*, Feb 2017, pp. 362–363.
- [5] B. Rumberg, D. W. Graham, V. Kulathumani, and R. Fernandez, "Hibernets: Energy-efficient sensor networks using analog signal processing," *IEEE Journal on Emerging and Selected Topics in Circuits and Systems*, vol. 1, no. 3, pp. 321–334, Sept 2011.
- [6] R. A. Dobre, V. A. Ni, A. Ciobanu, C. Negrescu, and D. Stanomir, "Low computational method for siren detection," in *2015 IEEE 21st International Symposium for Design and Technology in Electronic Packaging (SIITME)*, Oct 2015, pp. 291–295.
- [7] V. Gies, V. Barchasz, M. Fourniol, and H. Glotin, "Qualilife-jason advanced sound-light recorder," in *7th International DCLDE (Detection, Classification, Localization, and Density Estimation) Workshop*, June 2018.
- [8] V. Barchasz, V. Gies, and H. Glotin, "Technical report on high frequency recording systems," Scientific Microsystems for Internet of Things - SMIoT, University of Toulon, Tech. Rep., Sept 2017.
- [9] E. Alpman, "Overview of low-power wake-up radio design insights," in *2018 IEEE Custom Integrated Circuits Conference (CICC)*, April 2018, pp. 1–59.
- [10] F. Hflinger, G. U. Gamm, J. Albesa, and L. M. Reindl, "Smartphone remote control for home automation applications based on acoustic wake-up receivers," in *2014 IEEE International Instrumentation and Measurement Technology Conference (I2MTC) Proceedings*, May 2014, pp. 1580–1583.
- [11] H. O. Johansson, "A simple precharged cmos phase frequency detector," *IEEE Journal of Solid-State Circuits*, vol. 33, no. 2, pp. 295–299, Feb 1998.
- [12] A. Sanchez, S. Blanc, P. Yuste, and J. J. Serrano, "Rfid based acoustic wake-up system for underwater sensor networks," in *2011 IEEE Eighth International Conference on Mobile Ad-Hoc and Sensor Systems*, Oct 2011, pp. 873–878.
- [13] F. Ge and Y. Yan, "Deep neural network based wake-up-word speech recognition with two-stage detection," in *2017 IEEE International Conference on Acoustics, Speech and Signal Processing (ICASSP)*, March 2017, pp. 2761–2765.
- [14] G. Cauwenberghs, A. Andreou, J. West, M. Stanacevic, A. Celik, P. Julian, T. Teixeira, C. Diehl, and L. Riddle, "A miniature low-power intelligent sensor node for persistent acoustic surveillance," vol. 5796, 2005, pp. 5796 – 5796 – 12. [Online]. Available: <https://doi.org/10.1117/12.606859>
- [15] M. Fourniol, V. Gies, V. Barchasz, E. Kussener, H. Barthelemy, R. Vauche, and H. Glotin, "Low-power wake-up system based on frequency analysis for environmental internet of things," in *IEEE International Conference on Mechatronic and Embedded Systems and Applications*, July 2018.
- [16] R. Kojima, O. Sugiyama, R. Suzuki, K. Nakadai, and C. E. Taylor, "Semi-automatic bird song analysis by spatial-cue-based integration of sound source detection, localization, separation, and identification," in *2016 IEEE/RSJ International Conference on Intelligent Robots and Systems (IROS)*, Oct 2016, pp. 1287–1292.
- [17] K. Nakamura and K. Nakadai, "Robot audition based acoustic event identification using a bayesian model considering spectral and temporal uncertainties," in *2015 IEEE/RSJ International Conference on Intelligent Robots and Systems (IROS)*, Sept 2015, pp. 4840–4845.
- [18] T. Otsuka, K. Ishiguro, H. Sawada, and H. G. Okuno, "Bayesian non-parametrics for microphone array processing," *IEEE/ACM Transactions on Audio, Speech, and Language Processing*, vol. 22, no. 2, pp. 493–504, Feb 2014.
- [19] D. Rybach, R. Schlter, and H. Ney, "Silence is golden: Modeling non-speech events in wfst-based dynamic network decoders," in *2012 IEEE International Conference on Acoustics, Speech and Signal Processing (ICASSP)*, March 2012, pp. 4205–4208.
- [20] M. L. Chin and J. J. Burred, "Audio event detection based on layered symbolic sequence representations," in *2012 IEEE International Conference on Acoustics, Speech and Signal Processing (ICASSP)*, March 2012, pp. 1953–1956.
- [21] *PIC24FJ256GA412/GB412 Family : 16-Bit Flash Microcontrollers with Dual Partition Flash Memory, XLP, LCD, Cryptographic Engine and USB On-The-Go*, Microchip Technology Incorporated, 12 2016, rev. 2.0.

- [22] *Charge Time Measurement Unit (CTMU) and CTMU Operation with Threshold Detect*, Microchip Technology Incorporated, 4 2016.
- [23] *TPS783xx 500-nA IQ, 150-mA, Ultralow Quiescent Current Low-Dropout Linear Regulator*, Texas Instruments Incorporated, 11 2014.
- [24] *TLV3691 0.9-V to 6.5-V, Nanopower Comparator*, Texas Instruments Incorporated, 11 2015.
- [25] *TLV7031 and TLV7041 Small Size, nanoPower, Low-Voltage Comparators*, Texas Instruments Incorporated, 5 2018.
- [26] *CSS555C : Micropower Timer Datasheet*, Custom Silicon Solutions, Inc., 5 2009.
- [27] *CSS555C : Application Circuits - Application Note*, Custom Silicon Solutions, Inc., 5 2009.
- [28] P. Yedamale and J. Bartling, *ANI375 : See What You Can Do with the CTMU*, Microchip Technology Incorporated, 2 2011.
- [29] *Overview of Charge Time Measurement Unit (CTMU)*, Microchip Technology Incorporated, 3 2008.
- [30] *BCV62 PNP Silicon Double Transistor*, Infineon Technologies AG, 7 2011.
- [31] *REF200 Dual Current Source and Current Sink*, Texas Instruments Incorporated, 7 2015.
- [32] M. Fourniol and V. Gies, "Ultra low-power analog wake-up system for environmental iot networks and military smart dust," in *submitted to 2018 International Conference on Internet of Things and Intelligence System (IoT&IS)*, November 2018.
- [33] H. Glotin, M. Poupard, F. Monia, J. Ricard, V. Roger, V. Barchasz, V. Gies, and D. Geoffroi, "Analyse temps-réel de masse acoustique pour le suivi d'espèce nuisible à port-cros," Research Report, UTLN CNRS LSIS, Tech. Rep., Dec 2017.
- [34] "SMIoT : Scientific microsystems for the internet of things," Available: <http://www.smIoT.fr>, Tech. Rep., 2018.