



HAL
open science

Performance Evaluations in Optical and Wireless Networks for CONDOR project

Iness Ahriz, Jean-Michel Douin, Frédéric Lemoine, Anne Wei

► **To cite this version:**

Iness Ahriz, Jean-Michel Douin, Frédéric Lemoine, Anne Wei. Performance Evaluations in Optical and Wireless Networks for CONDOR project. The 9th International Conference on Ambient Systems, Networks and Technologies (ANT 2018), May 2018, Porto, Portugal. pp.73-81, 10.1016/j.procs.2018.04.014 . hal-02014801

HAL Id: hal-02014801

<https://hal.science/hal-02014801v1>

Submitted on 1 Jul 2022

HAL is a multi-disciplinary open access archive for the deposit and dissemination of scientific research documents, whether they are published or not. The documents may come from teaching and research institutions in France or abroad, or from public or private research centers.

L'archive ouverte pluridisciplinaire **HAL**, est destinée au dépôt et à la diffusion de documents scientifiques de niveau recherche, publiés ou non, émanant des établissements d'enseignement et de recherche français ou étrangers, des laboratoires publics ou privés.



Distributed under a Creative Commons Attribution - NonCommercial - NoDerivatives 4.0 International License



The 9th International Conference on Ambient Systems, Networks and Technologies
(ANT 2018)

Performance Evaluations in Optical and Wireless Networks for CONDOR project

Iness AHRIZ^a, Jean-Michel DOUIN^{a*}, Frédéric LEMOINE^a and Anne WEI^a

^a CEDRIC, Conservatoire National des Arts et Métiers, 292 rue Saint-Martin, 75003 Paris, France.

Abstract

Wireless and optical networks are widely used nowadays. These networks offer a high throughput thanks to their optical link and allow the development of multiuser applications. Because the network performance is an important issue to provide services to a great number of users while assuring users' quality of service requirements, CONDOR (CONtribution à la Diffusion de l'histOiRe du traitement de l'information à l'aide du réseau de demain) project aims to evaluate the wireless and optical networks' performances in terms of link quality, throughput, jitter and delay. Our results show that a high throughput in optical and wireless networks supports a big load through the launched mobile applications while P2P wireless network connections upset some video applications.

© 2018 The Authors. Published by Elsevier B.V.
Peer-review under responsibility of the Conference Program Chairs.

Keywords: Network performance, Mobile applications, P2P wireless network

1. Introduction

Nowadays, more and more mobile applications are developed thanks to the fast evolution of the communication technologies and the embedded systems. These applications can be implemented in a centralized way as well as in a distributed way using mobile devices. The type of implementation is closely related to the performances in terms of latency, throughput and delay, which are very sensitive in a multiusers context. This remains a challenge for the

* Corresponding author. Tel.: +33140272094; fax: +33140272709.
E-mail address: jean-michel.douin@cnam.fr

ubiquity of mobile applications, like for example, cultural and tourism guide applications^{1,2}. CONDOR project aims to evaluate the performance of optical and wireless networks based on the traffic generated by mobile services. CONDOR developed and deployed smartphone applications to facilitate the visit in museums, as a scenario. One of the mobile applications developed in the project is an interactive mobile path guide allowing visitors to reach quickly the artwork to be visited. Based on a sensor network, the path is estimated from the visitor's localization in the museum (room, corridor and passage). The interactive mobile path guide could work in two types: an estimated path based on a cloud-centric method or an estimated path based on M2M (Mobile to Mobile) method. In the first type, the mobile application connects to a cloudlet³, viewed as a server with a hypervisor connected remotely to a private cloud storage, in order to get museum maps and estimates the path knowing the actual mobile location. In the second type, the mobile application connects to another mobile device to get the museum maps and the path. The second solution assumes that some mobile devices store locally the required data, which avoids soliciting the cloudlet. Regarding the two types described above, the network has to support simultaneously the mobile-cloudlet and the M2M models. In the proposed scenario, the Quality of Service (QoS) in terms of throughput, packet delivery ratio and delay may be deteriorated due to the high number of museum visitors. In order to enable a certain QoS, CONDOR project uses a local optical network combined with wireless networks. To test and validate the network performance, we use real tests with prototypes. Real tests (physical testbeds) attempt to introduce real network environments^{4,5}. In this paper, we present the performance obtained in real tests conducted in the museum of arts and crafts of Paris. Both, mobile-to-cloudlet and mobile-to-mobile (M2M) architectures have been evaluated while considering the physical, transport and application layers. The remainder of this paper is organized as follows. The second section presents CONDOR network architecture and its characteristics. Then, section III describes some related works. Section IV highlights the measurement setup. Results are presented and discussed in Section V. Finally, we conclude our paper with some future works in section VI.

2. CONDOR Network Architecture

In CONDOR project, the network architecture consists of two main parts: wireless networks and an optical network. As described previously, the objective of this infrastructure is to reach a high throughput and enable the transmission of some multimedia contents with high quality, like for example HD videos in streaming. To support multimedia traffic, several new technologies are competitive. On one hand, we can have the WiGig/WiFi standard which offers a throughput up to 7GB/s and UWB (Ultra WideBand) on an upper 500 MHz bandwidth, while providing a throughput up to 480 Mb/s^{6,7}. On the other hand, the optical fiber evolves also very quickly since last decades. Today, the maximum flow can reach up to 400 Gb/s⁸. In this context, RoF (Radio over Fiber) technology allows the interconnection between wireless and optical networks. Thus, it is possible to transmit on optical fibers signals according to different standards, for example allowing the connection with GSM, UMTS, Wi-Fi or satellite. Furthermore, wireless sensors (SmartBeacon) and Bluetooth technology (Low Energy 4.0) are used.

The network architecture designed in CONDOR project is illustrated in Figure 1, where, the wireless network (IEEE 802.11ac) and the optical fiber network are interconnected via a RoF connector which converts an optical signal into an electrical signal and vice-versa. Furthermore, between mobiles devices, the ad-hoc network is built with Bluetooth technology (IEEE 802.15.1).

A RoF connector can be linked to multiple wireless IEEE 802.11ac routers while each Wi-Fi router can be connected to multiple wireless access points. Each access point forms a wireless communication cell where mobiles are connected to the wireless-optical network. According to the IEEE 802.11ac standard, theoretically wireless networks achieve a throughput from 1.3 to 7 Gb/s, unlike the IEEE 802.11n standard which allows to reach a maximal throughput of 600 Mb/s⁹. The optical fiber can support a throughput of 400 Gb/s.

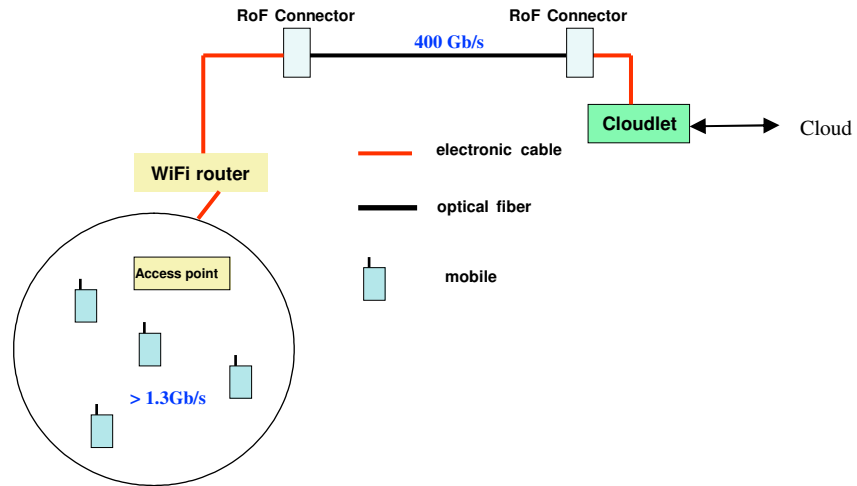

Fig. 1. CONDOR network architecture.

Since the wireless indoor connectivity is more difficult to achieve, we consider that each room of the museum is equipped with an access point. In this case, a mobile device can communicate with the museum server using the IEEE 802.11ac wireless network and the fiber optical network. Thanks to the high throughput provided by IEEE 802.11ac and the optical connection, the museum cloudlets are able to support high-quality multimedia contents requested by many visitors.

3. Related Work

Traditionally, the performance evaluation in networks depends on network types, because each network has its technical features to support its applications. Today, mobile applications are supported by mobile and wireless networks inter-connecting to other networks such as Internet and Ethernet. In this context, the network performance of smart mobile handhelds can be demonstrated in the context of a wireless network (WiFi, for example) or with a mobile network using HTTP protocol.

To evaluate wireless networks, M.D. Dianu et al. [presented a measurement-based study in IEEE 802.11ac wireless network. In an indoor environment, they have shown how the network throughput using UDP (User Datagram Protocol) applications could decline even if the distance between the transmitter and the receiver is small (up to 15m). Using Cisco Meraki system, the authors in¹⁰ presented wireless network behaviors and interference between nearby networks, sharing band and channel, as well as user applications performances.

Smart mobile applications have been paid attention by the research community since 2010. Hossein Falaki et al.¹¹ presented different mobile traffics such as HTTP requests, emails and video, while the authors in¹² demonstrated that smartphone applications based TCP have usually short messages with local delay problems. We summarize in Table. 1 the network performances as described in the literature.

In the literature, the authors considered different mobile cloud architectures to study the energy efficiency of the mobile devices. However, they did not measure the efficiency in terms of network communications^{20,21}.

In the best of our knowledge, this is the first case study relating to museum visit support. Our study focuses on network performance based on a traffic generated by mobile applications as illustrated for the museum-guide scenario. In the next section, we will describe our hardware and software platform used to conduct some experiments discussed later in Section 5.

Table 1. Network performances

Studied cases	QoS	Layer	Traffic	WiFi
Indoor	Throughput, delay	MAC and Physical layers	UDP traffic	IEEE802.11ac
Meraki	Frequency, channel	multi-layers	Video, music social photo...	IEEE802.11n
Mobile application	Delay, loss	Application layer	Web, social community, email...	unspecified
Mobile application	traffic	Application layer	HTTP request, email, video...	unspecified

4. Measurement setup

In this section, we introduce the hardware and software parts of our measurement setup.

4.1. Description of the hardware and software platform

To build our prototype, we used two wireless routers AC1750 Dual Band which work both in 2.4GHz and 5GHz¹³, one Wi-Fi key 802.11n Netgear N150 WNA1000M, another Wi-Fi key 802.11ac Linksys AE60000. Furthermore, some mobile devices and tablets (HTC Nexus 9, Samsung Galaxy S4) are used^{14, 15}.

For our experiments, we used the following free testing tools: Wi-Fi coverage, VisualRoute 2010, iperf, iwconfig and iwlist. Wi-Fi Coverage is a software which captures the received power from a Wi-Fi access point. It displays the received power, the emitted powers and the Wi-Fi throughput. These parameters depend on the distance between a device and the Wi-Fi access point. Iwconfig and iwlist provide some measurements at physical layer, like for example, noise level (dBm), signal level and link quality. VisualRoute 2010 supports the network diagnostic such as packet loss and response times by route trace. Iperf measures the performance by creating TCP and UDP data streams. According to the different layers, we used: (i) Wi-Fi Coverage to display the throughput, received power and SSID (Service Set Identifier) at the physical layer, and (ii) Iperf to show the received power, the throughput, the jitter, the link quality and latency at the transport layer.

To complete our tests, the mobile devices and tablets are also used to measure the throughput at the application layer (see Section VI-C). The cloudlet is a PC with a good capacity that hosts a hypervisor (VMWare/Xen)¹⁹. Each time some mobile device accesses to the cloudlet, a dedicated VM is launched to retrieve from the remote cloud the required data.

4.2. Test validation

The propagation model is an essential procedure at the beginning of every network deployment because it allows accurate coverage predictions. To validate the measurement of received power in respect to the distance between the Access point and the receivers, we use the following propagation model¹⁶:

$$L = P_0 + 20 \log_{10}(f) + 10 n \log_{10}(d) \quad (1)$$

Where P_0 : is a constant relative to antenna gain, f : is the frequency (MHz), d : is the distance between the transmitter and the receiver, n : is the pathloss component, and L is Pathloss (dB).

It can be easily seen that there is a linear relationship between the pathloss and the logarithm on the distance. This is what we want to show through the conducted measurements.

5. Performance study

CONDOR project supports mobile applications such as mobile path guide and high-quality multimedia contents. The prototype is installed in the Arts and Crafts Museum in Paris. We conducted performance measurements at three OSI layers: Physical layer, Transport layer and Application layer.

Based on the network architecture depicted in figure 1, the network performance is measured in terms of the received power, the channel quality (link quality), the end-to-end throughput, the jitter and the end-to-end delay. The end-to-end delay is presented by the minimum delay, the maximum delay and the average delay.

This museum contains three floors. Our tests are achieved in some rooms at the first floor. Figure 2 gives a layout of the 26th room of the museum and an example of eleven tests. In this room, the access point is installed at the bottom right corner, the eleven tests are positioned in the edge of the room (see circles).

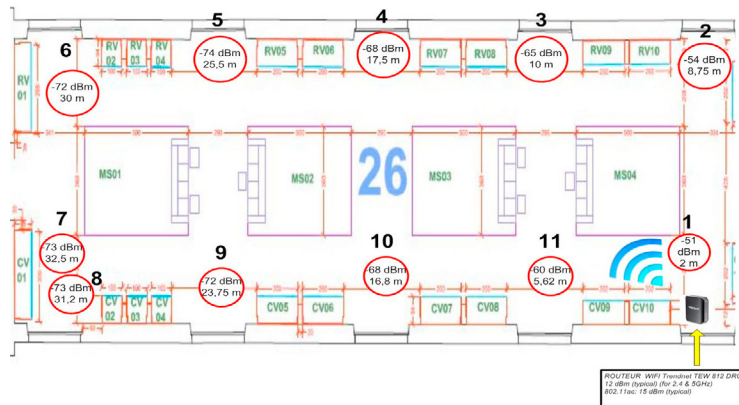

Fig. 2. Layout of the 26th room

5.1. Performance at the Physical layer

Using Wi-Fi Coverage, we evaluated the performance both in IEEE 802.11n and IEEE 802.11ac wireless networks. As shown in the Table 2, the received power is between -38 and -83dBm, the end-to-end latency is between 1 and 120ms, and the throughput is between 21 and 200Mbps. All the measurements are validated using the propagation model given by equation 1.

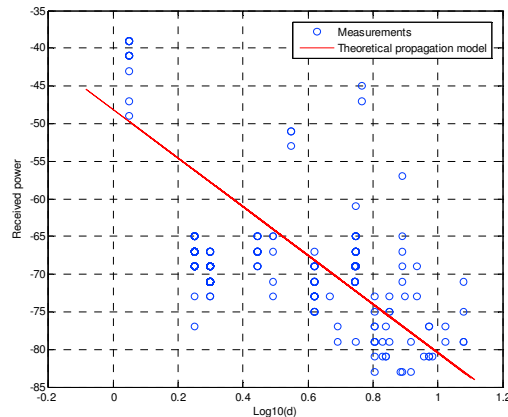

Fig. 3. Received power measurements in dBm as a function of distances

Figure 3 shows the received power with respect to the distance ($\log_{10}(d)$) to the transmitting access point. As we can see, the measurements fit well the propagation model in equation 1. Furthermore, the linear relation between the received power and the distance is verified.

Our measurements show that the IEEE 802.11ac wireless network supports three times more throughput (minimum and maximum) then the IEEE 802.11n wireless network. Even that the maximum throughput (200Mbps) is very far from the theoretical throughput (1.3Gbps), this is enough for our interactive mobile path guide if the number of visits in the same room is around 20.

5.2. Performance at the Transport layer

At the Transport layer, the Iperf tool uses TCP protocol to measure the throughput, the latency, the jitter, the link quality and the received power. As TCP protocol controls the uplink and the downlink throughputs by window's mechanism, we can observe both the uplink throughput (client request) and the downlink throughput (server response). Among our measurements, we present here some of our results due to the space limitation (Figures 4-7).

Table 2. received power, delay and throughput measurements in function of distances.

room n°	PC/tablet	Confidence interval	Distance (m)	Received power (dBm)	Delay (ms)	Throughput (Mb/s)
26	11n	2,7%	2~32,5	-51~-74	-	-
26	11ac	4,5%	1,9~32,5	-44~-75	1~120	54~200
26	11n	3,0%	2,5~32,8	-45~-64	-	38~72
22	11ac	3,8%	2~34	-42~-74	-	63~200
22	11n	5,8%	2,3~31,5	-45~-67	-	21~74

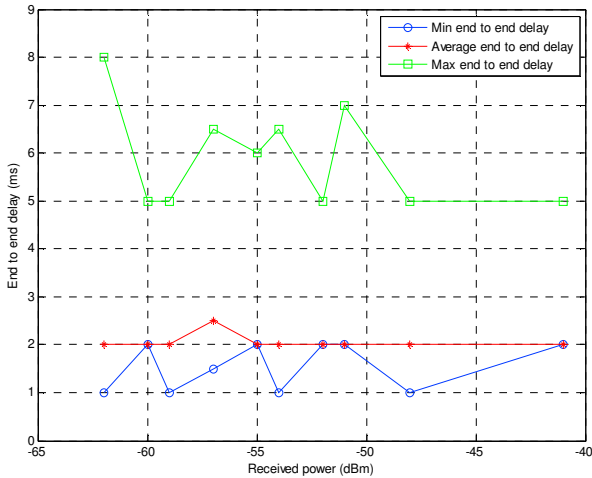

Fig. 4. Throughput as a function of received power

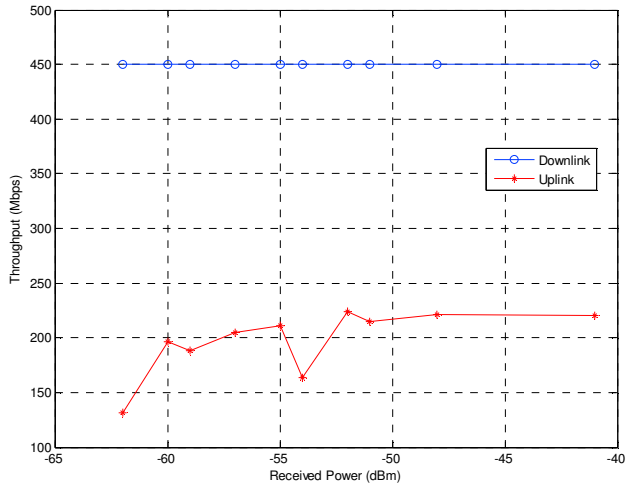

Fig. 5. Jitters as function of received power

Figure 4 presents our measurements in terms of average downlink throughput and average uplink throughput as a function of received powers. We notice that the downlink throughput is constant and equal to 450Mbps while the uplink throughput goes from 132Mbps to 224Mbps. The asymmetric throughput between downlink and uplink is a well-known IP characteristic. The uplink is used by requests which do not need an important throughput. This explains its small values. The downlink throughput is constant because of our test scenario which sends a file with

500Mo constantly. If the downlink throughput is constant, the downlink jitter varies from 2.26 ms to 9.19 ms as shown in figure 5. This latter shows also that the uplink jitter varying in the interval from 0.95 ms to 1.09 ms. A jitter, an interval time between two transmitted packets, can rise an undesirable transmission delay. However, if it does not reach the value 60ms, the multimedia quality remains acceptable. In this study, we also evaluate the end-to-end delays. Figure 6 shows the minimum end-to-end delay, the average end-to-end delay and the maximum end-to-end delay with respect to the received power. We can notice that the maximum latency reaches 8 ms, the minimum latency is 1 ms, while the average latency is about 2 ms. Even if the maximum end-to-end delay is up to 8 ms, the multimedia quality is widely supported in the network proposed by CONDOR project. According to our measurements, the link quality goes from 100% to 80%. If the visit is near to the wireless access point then the received power is strong enough to avoid transmission loss and to have 100% in term of link quality. Otherwise, we observe a link quality degradation until 80% with -62dBm of received power.

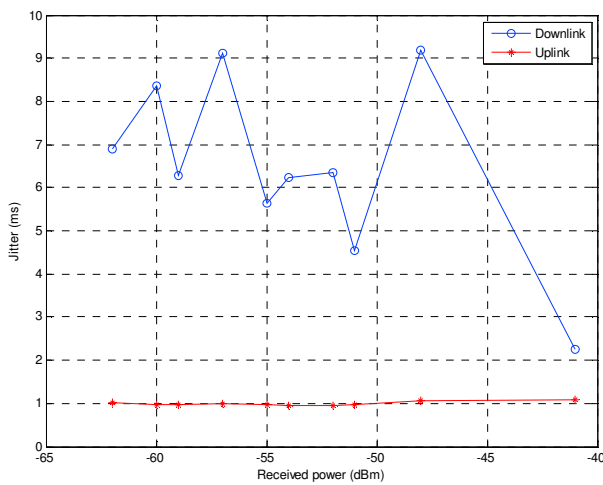

Fig. 6. End to end as a function of received power

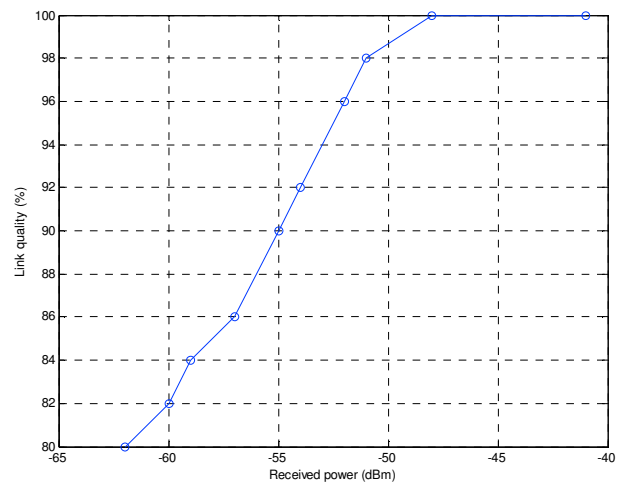

Fig. 7. Link quality as function of received power

5.3. Performance at the Application layer

At the Application layer, we use our mobile guide application developed for CONDOR project to measure the network performance. These measurements are focused on the throughput and the end-to-end delay. Our application consists of a web browser dedicated to the museum visit to which we added the measurements features. The downloaded application is used to assist the visitors of the museum visit. No specific configuration of the visitor mobile device is necessary. As a result, no Wi-Fi direct, no P2P, no specific protocol is required. Two modes are designed: classical Web and M2M modes. In Web mode, each visitor accesses through a server to museum Web pages as depicted in figure 8 (a). It is a simple web access called client-server with the HTTP protocol. In the M2M mode, a visitor receives museum Web pages from a nearby visitor in the same room, via the same Wi-Fi access point. In this case, mobile devices use the mDNS protocol to discover each other. Then one or several mobile devices become Web servers regarding the others as shown in figure 8(b, c). In our study, we tested the performance from one to ten visitor's mobile devices according to the Web mode. In our experiments, we used Samsung S4 and 9 Nexus smartphones. In figure 9, one mobile device behaves as a Web server. So we tested the performance using five mobile devices. In figure 10, two mobile devices have the role of a server with one device per visitor.

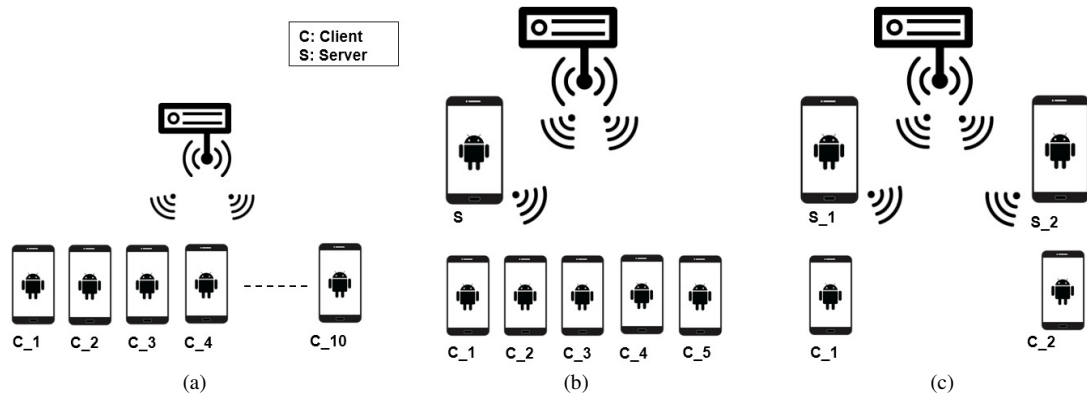

Fig. 8. (a) Classical Web mode, (b) A smartphone becomes Web server, (c) Two server smartphones with mobile clients

A 50MB file is used for all the file transfers and at least 100 iterations were performed in each case (see Table 3). Five test cases were made in a classical Web mode from one to ten transfers in parallel. We observe a degradation in terms of throughput (from 225 Mbps to 12 Mbps) and end-to-end delay (from 1.7s to 33.3s), while increasing the number of mobile devices.

Table 3. Throughput and end-to-end delay in classical Web mode (mobile device: md)

	1 md	2 md	3 md	4 md	5 md	6 md	7 md	8 md	9 md	10 md
Avg. transfer time (s)	1.7	2.3	3.1	3.6	5.1	6.9	9.8	11.4	17.3	33.3
Average throughput (Mbps)	225	173	129	111	78	57	40	35	23	12

In the M2M mode, a mobile device will download some Web pages of 50 MB before proposing them to the mobile neighbors. We consider the same measurement conditions with 100 iterations for each case. Table 4 presents our results. As in the classical Web mode, the number of mobile devices has an important impact. The throughput and the end-to-end delay decrease rapidly. For example, when two mobile devices download some Web pages simultaneously, the throughput is divided by more than two (from 240Mbps to 109Mbps). The mobile device that is close to the Wi-Fi antenna (S4 Samsung) becomes a server. We have added a sixth mobile device (S3 Samsung).

Table 4. Throughput and end-to-end delay, a mobile device (md) becomes server

	1 md	2 md	3 md	4 md	5 md
avg. end-to-end delay (s)	1.7	4	5	8	7.3
Average throughput (Mbps)	225	109	75	48	36

The same page of 50MB is downloaded simultaneously from two mobile servers. These two mobile devices located at the proximity of the Wi-Fi antenna are of S4 Samsung type. The throughput of 128Mbps is better than the initial configuration. Regarding these results, we conclude that the solution of having one or two mobile devices as servers represent a good solution for reducing the number of requests that can be processed by the main museum cloudlet. We have thus a collaborative cache web server located on each smartphone including existing protocols like HTTP. Furthermore, each museum room has a standard Wi-Fi installation. These scenarios represent the premises of a new informative system intended for the visit of a museum, in which data are shared between visitors with the help of their smartphones. Mobile interaction will become usual with the era of Internet of Things.

6. Conclusion and future works

In this paper, we present a performance study of a proposed network architecture. Optical fiber in the studied network is proposed to deal with the multiuser challenge in the context of interactive guided path for the museum tour. In fact, in such a context an acceptable QoS is needed to allow users accessing multimedia resources. The performance study has been conducted through real world experiments in different OSI layers. The results show that the proposed network architecture is suitable for multiusers context and allow deploying a guided path application in a museum. Such application is used to find a path to a desired art object. Furthermore, users can download a multimedia content related to a visited object. The presented study gives promising results. In a future work, we will use m-DNS technology which seems to be more suitable for multi-users guide path applications. The dynamic discovery of the mobile IP addresses is very interesting in our context. One user can thus easily connect to another neighboring user instead of the server. Performance evaluation in real conditions has to be carried out. We would also use DropLock framework¹⁸ and experiment the Google "nearBy" technology to improve service discovery.

Acknowledgements

This work on CONDOR project would not take place without our colleague Anne Wei commitment who left us abruptly this year. Authors present many thanks to Samia Bouzeffrane for her valuable advices and her support.

References

1. Louvre, "The Louvre-Nintendo 3DS audio guide", 7 pages, Louvre's document, 2016.
2. M. Kenteris, D. Gavalas and D. Economou, "Evaluation of Mobile Tourist Guides", WSKS 2008, Athens, Greece, September 24-26, 2008
3. S.R. Doshi and al, "Wireless Network Testing and Evaluation using Real-time Emulation", 16 pages, Scalable Network Technologies, 2007
4. D. Raychaudhuri and al, "Overview of the ORBIT Radio Grid Testbed for Evaluation of Next-Generation Wireless Networks protocols", 9 pages, IEEE WCNC 2005
5. R. Karrer, A. Sabharwal and E. Keightly, "Enabling Large-Scale Wireless Broadband : The Case for TAPs", 6 pages, Hotnets 2003 IEEE 802.11 Standard, 2014
7. ECMA-368 Standard, "High rate ultra wideband PHY and Mac", 2008
8. N.Bozinovic, Y.Yue, Y.X Ren, M. Tur, P.Kristensen, H.Huang, A. E. Willner, S. Ramachandran, "Terabit-Scale Orbital Angular Momentum Mode Division Multiplexing in Fibers", Science, n°340, 2013
9. M.D Dianu, J. Riihijarvi and M. Petrova, "Measurement-Based Study of the Performance of IEEE 802.11ac in an Indoor Environment", IEEE ICC 2014, Sydney, Australia, Juin 2014.
10. S.Biswas, and al. "Large-scale Measurements of Wireless Network Behavior", 13 pages, ACM SIGCOMM2015, August, 2015
11. X. Chen, R.Jin and al. "Network Performance of Smart Mobile Handhelds in a University Campus WiFi network", 14 pages, ACM, IMC2012, Boston, USA, Novembre, 2012
12. H. Falaki et al. "A First Look at Traffic on Smartphone", 14 pages, ACM, IMC2010, Melbourne, Australia, Novembre, 2010.
13. <http://us.dlink.com/products/business-solutions/wireless-ac1200-dual-band-access-point/>, Wireless AC1200 Dual Band Access Point.
14. http://www.gsmarena.com/htc_nexus_9-5823.php, HTC Nexus 9
15. http://www.gsmarena.com/samsung_i9500_galaxy_s4-5125.php, Samsung I9500 Galaxy S4
16. Pooja Rani, and al. "A Review on Wireless Propagation Models". 11 pages, IJEIT, Volume 3, Issue 11, May 2014
18. Thinh Le Vinh, Samia Bouzeffrane, Jean-Marc Farinone, Amir Attar, and Brian P.Kennedy, "Middleware to Integrate Mobile Devices, Sensors and Cloud Computing", 6th International Conference on Ambient Systems, Networks and Technologies (ANT 2015)
19. J.P. Walters, A.J. Younge, D. Kang, K. Yao, "GPU Passthrough Performance: A Comparison of KVM, Xen, VMWare ESXi, and LXC for CUDA and OpenCL Applications", 2014 IEEE 7th International Conference on Cloud Computing
20. Thinh Le Vinh, R. Pallavali, F. Houacine, S. Bouzeffrane. "Energy efficiency in Mobile Cloud Computing Architectures", The IEEE 4th International Conference on Future Internet of Things and Cloud, August 2016, pp. 326 - 331, Austria, (DOI: 10.1109/W-FiCloud.2016.72)
21. Keke Gai, Meikang Qiu, Hui Zhao, Lixin Tao, Ziliang Zong, "Dynamic energy-aware cloudlet-based mobile cloud computing model for green computing", Journal of Network and Computer Applications, Volume 59, January 2016, Pages 46-54.