



**HAL**  
open science

## A Hypothesis for the Elaboration of Heptatonic Scales

Amine Beyhom

► **To cite this version:**

| Amine Beyhom. A Hypothesis for the Elaboration of Heptatonic Scales. NEMO-Online, 2017. <hal-02012780>

**HAL Id: hal-02012780**

**<https://hal.science/hal-02012780v1>**

Submitted on 9 Feb 2019

**HAL** is a multi-disciplinary open access archive for the deposit and dissemination of scientific research documents, whether they are published or not. The documents may come from teaching and research institutions in France or abroad, or from public or private research centers.

L'archive ouverte pluridisciplinaire **HAL**, est destinée au dépôt et à la diffusion de documents scientifiques de niveau recherche, publiés ou non, émanant des établissements d'enseignement et de recherche français ou étrangers, des laboratoires publics ou privés.



HAL Authorization

## A Hypothesis for the Elaboration of Heptatonic Scales

Amine Beyhom\*

”ولم يستعمل الذي بالكل مرتين مفعولاً إلى أكثر من أربعة عشر بعداً، والذي بالكل مفعولاً إلى أكثر من سبعة أبعاد، والذي بالخمسة إلى أكثر من أربعة أبعاد تحيط بها خمس نغم، والذي بالأربعة إلى أكثر من ثلاثة أبعاد تحيط بها أربع نغم، والطنيني أكثر من بعدين. وإنما دعا إلى ذلك حسن اختيار لا ضرورة [...]“

*“The double octave will not comprise, in practice, more than fourteen intervals; the octave, more than seven; the fifth, more than four intervals and five degrees; the fourth, more than three intervals and four notes; the tone, more than two intervals. It is experience and not the theoretical need which dictates it [...]”*

[Ibn Sinā (Avicenna) – *Kitāb-a-sh-Shifā'*]<sup>1</sup>

\* Amine Beyhom is currently the editor in chief of NEMO-Online and director of the CERMAA (Centre de Recherches sur les Musiques Arabes et Apparentées), a research center affiliated to the FOREDOFICO foundation in Lebanon – he was at the time of the reading of the original paper (2008), and until the publication of the first version of this article (in 2010) an independent researcher associated to the PLM Research group at the University of Sorbonne – Paris IV.

<sup>1</sup> End of 10<sup>th</sup>, early 11<sup>th</sup> centuries AD; in Arabic [Sinā (Ibn) ou Avicenne (0980?-1037), 1956], p. 40-44; and in French [Fārābī (al-) et al., 1935], p. 138.

### FOREWORD<sup>2</sup>

As I pinpointed in 2003,<sup>3</sup> the reason for having eight notes in one octave is an arbitrary concept. There are diverging explanations of this common fact but none is satisfactory. This article gives an alternative explanation of this phenomenon. It is divided in two main parts:

- Part I, entitled “Differentiation, combination, selection and classification of intervals in scale systems: basic Modal systematics”, offers another view based on the theory of Modal Systematics, where basic principles are explained together with interval classification in the scale.

<sup>2</sup> This article is an emended, updated and enriched version of the paper entitled “A new Hypothesis for the Elaboration of Heptatonic Scales and their Origins” [Beyhom, 2010a] published in the proceedings of the ICONEA 2008 Conference. New research since its first publication presented complementary and sometimes clarifying facts (some of them exposed in the authors publications [Beyhom, 2012; Beyhom, 2014]) which, with the evolution of terminology (see [Beyhom, 2013] – in French), makes it indispensable to publish this new edition. Most of the tables and figures have been reintegrated in the body text, and a dedicated appendix (Appendix G) has been added concerning Octavial scales with limited transposition. To comply with NEMO-Online publishing policy, and as with all articles of the review since Volume 3, the pdf version includes bookmarks corresponding to the titles, sub-titles, tables and figures, which should help the reader navigate between the different parts of the article; additionally, one Power Point show illustrating (mainly) Appendix G with audio examples, is proposed as a complement at <http://nemo-online.org/articles>. A few complementary remarks: the ‘hypothesis’ is no longer new, and has never been challenged, to my knowledge, since its first publication in the Ph.D. thesis *Systématique modale* at the University of Sorbonne – Paris IV in 2003. It is published in this version as a complement to the dossier on Orientalism and Hellenism [Beyhom, 2016] and to the “Lexicon of modality” [Beyhom, 2013]. A copy of the original thesis [Beyhom, 2003c] can be obtained from <http://www.diffusiontheses.fr/> (id.: 03PA040073; Réf ANRT: 41905) in printed form (B&W), and the emended full version, together with most of my other musicological writings, are now downloadable free of charge at <http://foredofico.org/CERMAA/publications/publications-on-the-site/publications-amine-beyhom> as well as at <https://hal.archives-ouvertes.fr>. Finally: my heartfelt thanks go to Richard Dumbrell who invited me to participate in ICONEA 2008 (and who has read the article at my place, as various constraints prevented my attendance), translated the first version from the original French, then helped emendate the English text for the present version. This was even more welcomed as the original article (in French) was proposed beginning 2004 to musicological French speaking reviews, which did not accept it for publication.

<sup>3</sup> In my thesis [Beyhom, 2003c].

- Part II, entitled “Combining intervals in a system: Statistical analysis”, is a statistical analysis on the combination of intervals within the span of the just fourth, the fifth and the octave. It explores the systematic combination of intervals in scale elements,<sup>4</sup> and their filtering according to criteria inspired from traditional musics.
- The Synthesis that follows allows for the hypotheses on the formation of scale elements from the fourth to the octave and the elaboration of the heptatonic scale, and proposes clues in the search for the origins of heptatonism.

It is followed by a series of appendices:<sup>5</sup>

- Appendix A: “Scale elements in eights of the tone, within the containing interval of the fourth (= 20 eights of the tone)”,
- Appendix B: “Tables of the combination process for a just fifth”,
- Appendix C: “Complete results of the semi-tone generation within a Containing interval of fifth”,
- Appendix D: “Hyper-systems of the semi-tone octave complete alphabet generation”,
- Appendix E: “Additional graphs for octave generations, with the extended alphabet”,
- Appendix F: “Synoptic results for the quarter-tone generation”,
- Appendix G: “Octavial scales with limited transposition”.
- Appendix H: “Permutation processes for the combination of intervals”.
- Appendix L:<sup>6</sup> “Core glossary”.

Whenever Parts I and II are based on a learning process and explanations going from the simpler to the more complex (semi-tone generation to quarter-tone

<sup>4</sup> Be they included in a fourth, fifth or octave Containing interval: a Containing interval (see Part I for the complete definition) is one of the Acoustical structuring intervals in the scale (the Fourth, the Fifth and the Octave), with no melodic role.

<sup>5</sup> Former Appendix G in the 2010 version (complete database – quarter-tone model with reduced alphabet of intervals – now Appendix I), and new appendices J (generation of systems with the extended alphabet from 2 to 24 quarter-tones – raw results from the program Modes V. 5) and K (17<sup>ths</sup> of the octave full alphabet heptatonic generations of systems) are too voluminous to be included in the printed version: these can be downloaded from <http://nemo-online.org/articles>.

<sup>6</sup> See previous footnote.

generations,<sup>7</sup> in the frame of the fourth, then the fifth and octave containing intervals), understanding the Synthesis, while based on the results of the analysis, requires no special insight in mathematics or statistical knowledge.

### *Prefatory remarks*

The reasons given as to why the modern scale is made up of eight notes are unconvincing. Some suggest numerical relationships and their properties and others acoustic resonance.<sup>8</sup> There are also propositions stating the obvious: it is as it is because it cannot be different.

The first reason is based on the properties of numbers. It offers two alternatives, firstly the magical properties of numbers, and secondly the ratios between them. The first alternative is dismissed because it does not relate to musical perception.<sup>9</sup> Since Greek Antiquity, the second alternative has been the source of an ongoing dispute between the Pythagorean and the Aristoxenian schools.

The tetrad which was used by the Pythagoreans and their European followers provides the ratios of the predominant notes of the scale, as the Greeks perceived them.<sup>10</sup> However, it does not give any clues, and no other theory does, as to why the cycle of fifths, based on ratio 2:3, should end after its seventh recurrence.<sup>11</sup>

Later developments led to scales with twelve intervals, as in the modern European model, and seventeen with the Arabian,<sup>12</sup> Persian and Turkish paradigms.

<sup>7</sup> With one incursion in the eights of the tone model.

<sup>8</sup> These theories are explored at length, and refuted, in [Beyhom, 2016], Chapter III.

<sup>9</sup> Numbers 3, 4, 5, and 7, may play a role in the outcome of interval combinations, as shown in Part II of this article.

<sup>10</sup> [Crocker, 1963] and [Crocker, 1964]. The ratios 1:2 and 2:4 give the octave; the ratio 1:4, the double octave; 1:3 the octave + the fifth; 2:3, the fifth and 3:4, the fourth. These intervals were the principle consonant intervals in Pythagorean and Aristoxenian theories. In order of their consonant quality, first comes the octave, then the fifth and lastly, the fourth – more detailed explanations are available in Chapter III of [Beyhom, 2016].

<sup>11</sup> Or twelfth, or more: see Chapter III in [Beyhom, 2016] for more details.

<sup>12</sup> I use the terms “Arabian music” as a generic concept applying to *maqām* practice, although Farmer, in his “Greek theorists of

There are no reasons either for the fourth<sup>13</sup> to be made up of three, or for the fifth to be made up of four intervals.

Then the Aristoxenian school raised a point of particular importance when it pointed out that the practice of performance and the perception of intervals are the keys to theory.<sup>14</sup>

The Pythagorean construction of intervals, which in part is based on superparticular intervals,<sup>15</sup> misled many theoreticians<sup>16</sup> into believing that acoustic resonance might explain the construction of the scale, on the basis of its similarities with it. However, this is inconsistent with the predominance of the fourth in Greek theory and, for example, in Arabian theory and practice today. Acoustic resonance shows that the fourth is not the consequence of a direct process.<sup>17</sup>

–  
Music in Arabic Translation” [1930], writes that the use of “Arab” is well attested, notably in note 1, p. 325: “I use the term ‘Arab’ advisedly, just as I would use the word ‘English’, at the same time implying the Scots, Irish, & Welsh. ‘Islamic’ or ‘Muslim’ will not serve, because Magians, Jews & Christians, contributed to this ‘Arabian culture.’” We shall include in this wide definition Turkish and Persian music, as well as other *maqām* music with, mainly, heptatonic scales and “neutral” (this term is defined below) intervals used in the latter.

<sup>13</sup> Additionally, the (Neo-)Pythagorean cycle of fifths does not generate a fourth. The scale is the consequence of an ascending cycle of fifths, bringing notes placed above the first octave back into it, hence F G A B c d e. The fourth, ascending from starting F, is F-B which is a Pythagorean tritone; see also Chapter III in [Beyhom, 2016].

<sup>14</sup> [Aristoxenos and Macran, 1902], p. 193-198, notably (p. 193-194): “For the apprehension of music depends on these two faculties, sense-perception and memory”; or p. 197: “That no instrument is self-tuned, and that the harmonizing of it is the prerogative of the sense perception is obvious.”

<sup>15</sup> Intervals with string/frequency ratios of the type  $(n+1)/n$  when  $n$  is a positive integer.

<sup>16</sup> See [Chailley, 1959] and [Chailley, 1985], p. 64-65.

<sup>17</sup> Acoustic resonance is not a generative process as such, but it is the consequence of the physical (and dimensional) properties of matter set to vibration. The integration of acoustic resonance within a generative theory is subjective as it admits that vertical relationships cannot be unidirectional, *i.e.*, ascending; for the particular case of the fourth, a computer program has been used to test this hypothesis, up to the 1500<sup>th</sup> harmonic, and gave no exact matches for the just fourth. A first approximation is found at the 341<sup>st</sup> harmonic, with about 496 cents, then 499 cents with the 683<sup>rd</sup> harmonic. The closest is the 1365<sup>th</sup> harmonic with 498 cents. The calculations were based on the formula:  $i = 1200 \times \ln(R)/\ln(2)$ , where ‘i’ is the interval in cents, ‘R’ the ratio of frequencies (the ratios of frequencies are 341, 683 and 1365, respectively), and then extracting modulo of  $(i/1200)$ . In

There are strong arguments in favor of the consonance with the just fourth.<sup>18</sup> However, acoustic resonance fails in that neither can it generate modal scales,<sup>19</sup> nor can it give satisfactory answers as to the number of eight pitches in the octave, or four in a fourth.<sup>20</sup>

## PART I. DIFFERENTIATION, COMBINATION, SELECTION AND CLASSIFICATION OF INTERVALS IN SCALE SYSTEMS: BASIC MODAL SYSTEMATICS

The study of interval combination within a fourth or a fifth would have entertained scholars since music and mathematics were found to suit each other. Aristoxenos had limited combination techniques for his

–  
analytical terms, the problem consists in finding an integer  $J$ , which multiplies  $N$ , the frequency of the fundamental tone, and the ratio of which, to the nearest and lower octave (octaves of the sound with frequency  $N$  have the form  $2^k \times N$ , where  $k$  is an integer number) is equal to  $4/3$ , or  $[(J \times N)/(2^k \times N) = (4/3)]$  ( $k$  is the power indicator of 2, with  $2^k \times N$  being simply an even multiple of  $N$ ), which is not possible because in this case  $[J = (2^k \times 4)/3]$ , and neither 4 nor a power of 2 ( $2^k$ ) can divide 3 – more about the Acoustic resonance theory in [Beyhom, 2016].

<sup>18</sup> [Helmholtz, 1895], p. 192-194 (figs 60A and 60B, p. 193). The consonance of the fourth is explained in that two simultaneous notes at a fourth apart have some theoretical harmonics in common, as for example for two notes at (1) 300Hz and (2) at 400Hz, which have common harmonics with frequencies equal to 1200, 2400, 3600Hz (etc.), *i.e.*, for every common multiple of 300 and 400 – more in [Beyhom, 2016].

<sup>19</sup> In [Beyhom, 2016], Chapter III, I explain how the only conceivable (melodic) scale in the Acoustic resonance theory is the zalzalian (*i.e.* of the *maqām* type – see footnote no. 44) Ptolemaic suite 8:9:10:11:12 which results in the “equal diatonic” pentachord (expanded from the corresponding tetrachord with ratios 9:10:11:12). See also next footnote.

<sup>20</sup> In order to assemble a very approximate octave made up of the degrees of the ditonic (for “containing two tones in a Just Fourth”, *i.e.* the so-called “diatonic” – in fact “tense diatonic” as reminded in [Beyhom, 2016]) scale in Western theories of the scale, various resonance theories (mostly notations) generally end up at the fifteenth harmonic (sometimes the sixteenth), which is a ‘b’ if the fundamental is ‘c’ or, ‘e’ if the fundamental is an ‘f’. This is an arbitrary proposition since no reason is given for having chosen the fifteenth harmonic as a last pitch while this would require extraordinary hearing powers, since this fifteenth harmonic placed right below the fourth octave has generally little intensity. Therefore preceding pitches from the 7<sup>th</sup>, 11<sup>th</sup> and 14<sup>th</sup> harmonics, theoretically, should be heard much louder than the 15<sup>th</sup> harmonic.

understanding of what is commonly named *genera*,<sup>21</sup> but should be considered as plain tetrachords as very few indications on Music practice exist in Ancient Greek manuscripts.<sup>22</sup> (Al-) Fārābī<sup>23</sup> saw them as systematic combinations.<sup>24</sup>

<sup>21</sup> This process is plainly explained in [Barbera, 1984], especially p. 231-232: “Aristoxenos has described the enharmonic *genus* in such a way that there can exist only three species of fourth. This is so because he has allowed only two different intervals, the enharmonic diesis or quarter-tone and the ditone, to enter his discussion. Thus, we can arrange two quarter-tones and one ditone in at most three different ways. Had Aristozenos considered a chromatic *genus* containing three different intervals, for example, 1/3 tone, 2/3 tone, and 1 ½ tones, what would have been the result? Later writers make clear that the six possible arrangements of these three intervals were not all possible musically. In fact, only the first, second, and third species were musical possibilities, *i.e.*, those species that are arrived at by making the highest interval the lowest or vice versa, leaving the rest of the sequence unchanged. The three arrangements that are not considered are neglected, I believe, because they are not species of a musical *genus*. A *genus* is, after all, a tuning, or more precisely, infinitely many tunings within firmly established boundaries. Such tunings presume a musical scale or system as background – a first note or string, a second note, third, and so forth. One can focus attention on any four consecutive notes of the scale and, depending upon the segment of the scale that is chosen, one can discern a variety of species. At no point, however, can one alter the sequence of notes of the scale. For instance, the third note of the system never becomes the second note. Therefore, because a system – the Greek musical scale – is assumed, and because species must be species of a *genus*, there can exist only three, not six, species of any specific tuning of a musical fourth” – this is further explained in this article in relation to intervals combination.

<sup>22</sup> See previous footnote; Greek manuscripts exist only as late copies as pinpointed in Chapter I of [Beyhom, 2016].

<sup>23</sup> There are two major theoreticians of Arabian music from old, Abū-n-Naṣr Muḥammad ibn Muḥammad ibn Tarkhān al-Fārābī (9<sup>th</sup>-10<sup>th</sup> centuries) and Ṣafiyū-a-d-Dīn ‘Abd-al-Mu’min ibn Yūsuf ibn (ab-i-l-Ma)Fākhir al-Urmawī (d. 1294). Urmawī’s theoretical concept of the scale is a Pythagorean adaptation of the 17-intervals scale found in all theoretical and practical writings on Arabian music since Ya’qūb ibn Ishāq Abū Yūsuf al-Kindī (0801?-0867?), the “Philosopher of the Arabs” who was the first to use Ancient Greek theories to (try) describe Arabian music at his time – see [Beyhom, 2010b].

<sup>24</sup> [Fārābī (al-), 1930], p. 127: “Should a consonant interval be repeated within a group, the small intervals could be situated at different places in that group. Thus the fifth having been placed within a group with a certain arrangement of its small intervals, one can, within the same group have other fifths having their small intervals arranged in another way. For instance, the first interval in the first arrangement might be the last in another. In the case an interval is seen often in a group with its small intervals differently arranged, each of these arrangements of small intervals form a *genus*, a species, of a group. Within an interval, the arrangement of small intervals it contains can be classified as first,

The combination of intervals must obey rules. Thus heptatonism is made up of a small number of consecutive intervals which we shall call conceptual. They are placed in larger containing<sup>25</sup> intervals, such as the fourth, the fifth or the octave. Aristozenos used the quarter-tone as the smallest interval in his scales and tetrachords. With Cleonidēs the twelfth of the tone was a common denominator for all intervals.<sup>26</sup> Fārābī divided the octave in 144 equal parts.<sup>27</sup> This is twice the amount as in Cleonidēs. This shows that Fārābī was influenced by the Harmonists, as Aristozenos had them labeled. These scholars were focused on tonometry and generally used a small common denominator for a maximum of accuracy in their quantification<sup>28</sup> of intervals.<sup>29</sup> However, the Aristozenian school<sup>30</sup> favored the largest possible common denominator, *i.e.*, an interval which can also be used as a conceptual interval (a second among intervals building up to larger containing intervals such as the fourth, the fifth or the octave).

Let us take a tetrachord<sup>31</sup> with a semi-tone or a quarter-tone as largest common denominator, within a fourth. To find out how many semi-tones make up a fourth, add semi-tones, one after the other until the

→ second, etc., until the various arrangements in this group are exhausted.”

<sup>25</sup> Or “container”, or “delineating”.

<sup>26</sup> [Cleonidēs, 1884], *L’introduction harmonique*, (ed. and tr. Ruelle, Ch.), notably §71: “Differences are produced numerically in the following manner. Having agreed that the tone is divided in twelve small parts each of which called a twelfth of a tone, all the other intervals have a proportional part in relation to the tone.”

<sup>27</sup> [Fārābī (al-), 1930], p. 59 *sq.*

<sup>28</sup> Metrologic accuracy is essential to mathematical precision. However, Fārābī himself acknowledges that music performance dismisses very small intervals in the scale – see [Fārābī (al-), 1930], p. 174-176.

<sup>29</sup> The “Harmonists” are supposed to have used the (exact) quarter-tone as a common denominator for their scales: this may be short of the truth (see Appendix 2 of [Beyhom, 2016]), as the Harmonists had 28 (and not 24) “quarter-tones” in their scales.

<sup>30</sup> Not Aristozenos as he had a more complex understanding of intervals (a fact that has been overseen by most followers and critics), and used Pythagorean mathematics imbedded in his explanations of typical tetrachords – see Appendix 3 of [Beyhom, 2016].

<sup>31</sup> The term *genus* will only be used for the melodic expression of a tetrachordal polychord (= “made of multiple conjunct intervals of second”); the same applies, as pinpointed in [Beyhom, 2013; 2016], to the terms “mode” and “scale”.

fourth is filled up (Table 1). These intervals make a form of alphabet the letters of which being multiples of semi-tones.

- 1 = 1 semi-tone
- 1 + 1 = 2 semi-tones, or one tone
- 1 + 1 + 1 = 3 semi-tones, or one-and-a-half-tones
- 1 + 1 + 1 + 1 = 4 semi-tones or a ditone
- 1 + 1 + 1 + 1 + 1 = 5 semi-tones or the approximate fourth

**Table 1** Interval alphabet in an approximate fourth (in semi-tones).

In Table 1, the intervals labeled 1, 2, etc., are integers. They are multiples of the largest common denominator which is the semi-tone. If we place three intervals in a fourth, other intervals may not fit in any longer.

For example, if we place two of the smallest semi-tone intervals, the largest interval to fill up the fourth is one-tone-and-a-half, that is three semi-tones. When a fourth is made up of three intervals, the alphabet is reduced and has only intervals equating to one, two or three semi-tones.

The tetrachords made from the systematic combination of the intervals in the alphabet constitute the well-known six tetrachords of semi-tone scales (Table 2), among which the first<sup>32</sup> and the fourth<sup>33</sup>, are mentioned by Aristoxenos.

- 1 1 3 (semi-tone, semi-tone, one-and-a-half-tones) – “tonic chromatic” of Aristoxenos
- 1 3 1 (semi-tone, one-and-a-half-tones, semi-tone)
- 3 1 1 (one-and-a-half-tones, semi-tone, semi-tone)
- 1 2 2 (semi-tone, tone, tone) – “tense diatonic” of Aristoxenos
- 2 1 2 (tone, semi-tone, tone)
- 2 2 1 (tone, tone, semi-tone)

**Table 2** Species of tetrachords made from multiples of the semi-tone.

The first three *species*<sup>34</sup> have two classes of intervals: the semi-tone class, 1, and the one-and-a-half-tones class, 3. This also applies to the three other diatonic<sup>35</sup> tetrachords, but in this case with intervals of

<sup>32</sup> ‘1 1 3’ (two adjacent semi-tones followed by one one-and-a-half-tones interval): [Aristoxenos and Macran, 1902], p. 202-203.

<sup>33</sup> ‘1 2 2’ (semi-tone, tone, tone): [Aristoxenos and Macran, 1902], p. 204.

<sup>34</sup> These are defined as sub-systems in Modal systematics.

<sup>35</sup> Understand as *tense diatonic* (or Western diatonic), as many other shades of diatonic tetrachords exist as explained in [Beyhom, 2016], Chapter I, and in [Beyhom, 2010b ; 2015b].

one semi-tone, 1 and one-tone, 2. Interval classes can be expressed as capacity vectors, according to the number of intervals of each size they have (Table 3).

Another approach to the problem would devise a literal expression for the size of intervals expressed as multiples of the semi-tone, and then, arbitrarily, assigning the system amounting to the least integer number, as indicator of capacity.

Int. size:→	1	2	3	Vectors
	Number of intervals of this size contained in the tetrachord			
Tetrachords:↓				
1 1 3	2	0	1	(2,0,1)
1 3 1	2	0	1	
3 1 1	2	0	1	
1 2 2	1	2	0	(1,2,0)
2 1 2	1	2	0	
2 2 1	1	2	0	

**Table 3** Capacity vectors for tetrachords on a semi-tonal basis.

A good example is the tetrachords with two one-semi-tones and one one-and-a-half-tones additional interval (Table 4). The digits of the intervals are concatenated in a single integer. The lowest number in the series of three is 113. If we assign the smallest number in the series as a capacity vector, we need only count the number of occurrences of each interval. We start with the smallest one to find out what is the capacity of the corresponding scale systems. This is known as a hyper-system.

From scalar systems to integer numbers			Capacity vector	Hyper-system
Sub-systems	concatenated number	Read		
1 1 3	113	one hundred and thirteen	(2,0,1)	113
1 3 1	131	one hundred and thirty-one		
3 1 1	311	three hundred and eleven		

**Table 4** Expressing the scale systems “1 1 3”, “1 3 1” and “3 1 1” as integer numbers and deriving the capacity vector and hyper-system (sub-system resulting in the smallest integer number).

Taking, for example, vectors (2,0,1) and (1,2,0), with corresponding hyper-systems 113 and 122 as basis for generating remaining combinations, the intervals in each hyper-system can be combined differently in three sub-systems, or unique arrangements of intervals contained in the hyper-

system (Table 4). The reason for this is that each model contains a semi-tone which is repeated, in the first hyper-system and two one-tone intervals for the second. The outcome of the combination of intervals in a hyper-system containing three different intervals would be different. However, this configuration does not exist for semi-tone integer multiples.

### *Conceptual, quantification, and elementary intervals: Understanding theory and practice*

In the Western equal-temperament scale,<sup>36</sup> also known as the 12-ET system (equal temperament with 12 intervals in the octave), both conceptual and quantification intervals may have the same value. The semi-tone is half of a tone. It is the smallest interval and therefore divides the fourth into five semi-tones. The fifth, is made of seven semi-tones: three tones and one half-tone. The octave has twelve semi-tones, that is six tones. The cent being equal to one hundredth of a semi-tone, appears to be more accurate. However, it has little purpose with the 12-ET since the semi-tone is the exact divider for all larger intervals.

With other systems,<sup>37</sup> the smallest interval used, in theory, may neither be a divider of other intervals, nor a conceptual interval, or an interval which is used in the scales and melodies of a particular type of music. An example of it is the systematic scale defined in the first half of the 13<sup>th</sup> century by Şafiyi-a-d-Din al-Urmawī, in his *Book of cycles*.<sup>38</sup> There, the smallest

<sup>36</sup> More than two thousand years ago, Ancient Greek theory included the semi-tone equal temperament which is in use in most Western music today (classical, to some extent, and pop music in general), together with modern Arabian quarter-tone divisions of the octave. Aristoxenos' theory is reportedly based on an equal-temperament division. He defines the fourth as composed of five semi-tones (see [Aristoxenos and Macran, 1902] p. 208); in both Ancient Greek theory and practice, however, equal-temperament was never used, because exact computation of the intervals of equal-temperaments was not possible. Moreover, and as reminded in [Beyhom, 2016] – Chapter I, Aristoxenos' concept of the scale was never based on equal-temperament. This is one of the reasons why intervals functions must be differentiated from their measurements.

<sup>37</sup> Such as many types of unequal temperaments.

<sup>38</sup> Urmawī's *Book of cycles* is extensively analyzed by Owen Wright in *The Modal System of Arab and Persian Music A.D.1250-1300*, [Wright, 1969]. There appears to be no translation in English. There is a translation in French by Erlanger (1938) but there he refers to a commentary (the *Sharḥ Mawlānā Mubārak Shāh bar Adwār*) which he attributed to Şafiyi-a-d-Din al-Urmawī, under

conceptual interval<sup>39</sup> is the *leimma*. The tone, is made up of two *leimmata* and one *comma*, both Pythagorean.<sup>40</sup> The *leimma* is equated<sup>41</sup> to the semi-tone. Therefore, a typical tone may take the form L + L + C, where 'L' stands for the *leimma*, and 'C' for the *comma*. Therefore a pitch can be placed in a scale on the boundaries of these intervals.<sup>42</sup>

In this case, the *leimma*, and the *comma* play the role of elementary intervals (they are used to make up other intervals in the scale). However, the *comma* is not a conceptual interval because it is never used as such between neighboring pitches of a scale<sup>43</sup> but only as part of another and larger conceptual interval.

The *comma* and the *leimma*, make up conceptual intervals used in the composition of other intervals such as the “neutral”<sup>44</sup> – or *zalzalian* – second, called

→

the title of *Kitāb al-Adwār* [“*Livre des cycles musicaux*”], in *La Musique Arabe*, Vol.3, [Urmawī (d. 1294) and [Jurjāni (al-)], 1938]. In the same volume, Farmer (p. XIII of Erlanger's translation) ascribes it to 'Alī ibn Muḥammad a-s-Sayyid a-sh-Sharīf al-Jurjāni.

<sup>39</sup> Reminder: a stand-alone interval in the scale.

<sup>40</sup> The Pythagorean *comma* amounts (notably) to six Pythagorean tones (8:9) from the sum of which one octave is taken away. The *comma* has the ratio of 524288:531441, which is about 23 cents. This discrepancy can be described as the consequence of the Pythagorean tone, about 204 cents being slightly larger than the equal temperament tone at 200 cents. Therefore the octave is made up of five tones and two *leimmata*. The Pythagorean fifth is made up of three tones and one *leimma* (about 702 cents), and the fourth, of two tones and one *leimma* (498 cents). The *leimma* is the 'left over' quantity between two Pythagorean tones away from a fourth. This amounts to a ratio of 243:256, about 90 cents.

<sup>41</sup> The *leimma* is (see previous note) the complement of the Pythagorean ditone within the just fourth of ratio 3:4.

<sup>42</sup> One of Urmawī's (intervallic) octave representations runs as: L L C, L L C, L, L L C, L L C, L L C, L L C, L. Placing notes at Pythagorean boundaries, we have *c* (L L C) *d* (L L C) *e* (L) *f* (L L C) *g* (L L C) *a'* (L L C) *b'* (L) *c'*. In the *maqām Rāst* of Arabian music, as defined by Urmawī, the boundaries stand differently: *c* (L L C) *d* (L L) *e'* (C L) *f* (L L C) *g* (L L C) *a'* (L L) *b'* (C L) *c'*. The intervals between *d* and *e'* (or for the latter a pitch which stands between *e* flat and *e* sharp) and between *e'* and *f* are the *mujannab*, or *zalzalian* seconds of Urmawī. The same applies to the intervals between *a'* and *b'* and *c'*. Their value is (L+L) or (L+C), but both hold the same name of *mujannab*, whilst intervals such as the *leimma* 'L' or the tone, have one single interval capacity, that is one *leimma* for the semi-tone (with Urmawī), and two *leimmata* and one *comma* for the tone.

<sup>43</sup> Or in a melody.

<sup>44</sup> Because this term, used by Orientalists, is biased and gives the ditonic system the priority on other music systems (and compels me to use double quotes for “neutral” all over the text of this

→

*mujannab* which, according to Urmawī, can be made up of two *leimmata* (i.e., L + L) or with one *leimma* plus one *comma* (i.e., L + C or C + L).

The difference between the two zalzalian seconds, i.e., the difference between two *leimmata* and one *leimma* plus one *comma* (Fig. 1), or  $[(L + L) - (L + C) = (L - C)]$ , is about 67 cents, almost three Pythagorean *commata*.

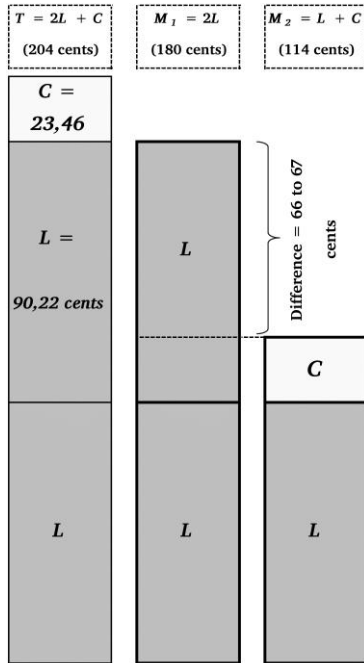

Fig. 1 Urmawī's tone (left) and two expressions of the *mujannab* (center and right): T = tone, M = *mujannab*, L = *leimma* and C = *comma*.

→  
article), I shall use exclusively the term *zalzalian* from this point on to characterize such intervals. As explained in [Beyhom, 2016], Zalzalian divisions of the scale are generally deduced from the existence, in a containing (or delineating) interval (i.e. a fourth, a fifth, an octave), of small(er) structuring intervals the values of which are frequently expressed as odd multiples of the (approximate) quarter-tone. The term “Zalzalīan” {from Maṣūf Zalzal a-ḏ-Ḍārib, an 8<sup>th</sup>-9<sup>th</sup>-centuries *ūd*ist who was – supposedly – the first to introduce the fingerings of the *mujannab*(s) – i.e. the so-called zalzalian seconds and thirds – on the neck of the *ūd*} refers more generally to intervals (or musical systems which use them) using other subdivisions as the semi- (or “half-”) tone, noticeably all the varieties of *mujannab* seconds spreading from the exact half-tone to the disjunctive (Pythagorean) tone – see Fig. 5: 14 (references to figures and tables have page numbers, when needed, after a colon); the same applies to intermediate intervals between the (exact or Pythagorean) tone and the one-tone-and-a-half interval (either equal-tempered or Pythagorean “augmented” second), etc.

Conceptually, however, the two possible forms of zalzalian seconds, with Urmawī, are equal (Fig. 2). Both are called *mujannab* and considered as intermediate intervals placed between the *leimma* and the tone.



Fig. 2 Excerpt from an autograph<sup>45</sup> by Urmawī of the *Book of Cycles* which illustrates the conceptual equality of the two forms of the *mujannab* (and of the use of elementary intervals as conceptually equal).<sup>46</sup>

Arabian theory has hardly changed since Urmawī.<sup>47</sup> Modern scholars give two principal representations of a scale with all possible locations of pitches. The first is an approximation of the general scale with Holderian commas,<sup>48</sup> HC, henceforth, and the second uses the quarter-tone for quantification.

A HC equates to 1/53<sup>rd</sup> of an octave, about 23 cents (22.6415)<sup>49</sup>. Therefore one *leimma* equates to four HC, about 91 cents. This is close enough to the Pythagorean *leimma*. The tone is 9 HC, or 204 cents, matching the Pythagorean tone. Typically, a tense diatonic (or ditonic) tetrachord<sup>50</sup> is modeled as a succession of two Pythagorean tones of 9 HC each, plus a *leimma* with 4 HC. The *mujannab* of Urmawī, which amounts to a zalzalian second, has two possible values in Modern Arabian theories of the scale, 6 HC

<sup>45</sup> According to Owen Wright (Personal communication).

<sup>46</sup> [Urmawī (al-), 2001, p. 6].

<sup>47</sup> The concept remains the same throughout history, and is based on the division of the tone into three small intervals and on the division of the zalzalian second in two other, even smaller ones – see [Beyhom, 2007c ; 2010b].

<sup>48</sup> The modern concept of divisive commas is different from the Ancient Greek concept based on ratios; therefore, the Pythagorean *comma* is written in italics in this article, which is not the case with the Holderian comma.

<sup>49</sup> Accuracy to the 4<sup>th</sup> decimal is needed only for computational purposes as in practice anything under two cents is hardly noticeable – more in [Beyhom, 2016].

<sup>50</sup> The tense diatonic [ditonic] *genus* is the Western paradigm as explained above.

or 7 HC, but they are considered as identical conceptual intervals (Fig. 3).<sup>51</sup>

The first division of the octave, the 53-ET giving the Holderian comma as a common divisor of all conceptual intervals, follows, in Modern Arabian theory, complex rules.<sup>52</sup> The second division of the octave, in 24 theoretically equal quarter-tones, will demonstrate a privileged example of interval relationship.

Values (HC)	N°	Note	Intervals	Note	N°	Values (HC)
53		c'		c'		53
52						52
51						51
50		b	M	M		50
49						49
48						48
47						47
46						46
45		T		b <sup>flat</sup>		45
44						44
43						43
42						42
41		a		a		41
40						40
39						39
38						38
37						37
36		T	T			36
35						35
34						34
33						33
32		g		g		32
31						31
30						30
29						29
28						28
27		T	T			27
26						26
25						25
24						24
23		f		f		23
22						22
21						21
20		e	M	M		20
19						19
18						18
17						17
16						16
15						15
14		T		e		14
13						13
12						12
11						11
10		d		d		10
9						9
8						8
7						7
6						6
5		T	T			5
4						4
3						3
2						2
1		c		c		1

Fig. 3 Comparison between the modeling of the Pythagorean tense diatonic scale (left) and of the Arabian *Rāst* scale (right) with Holderian commas.

<sup>51</sup> For example in [Ṣabbāgh (a-ṣ-), 1950].

<sup>52</sup> Ṣabbāgh uses (p. 29 for example in the aforementioned book of this author), the terms ‘flat plus one quarter’ for the note *e* in the scale of the mode *Rāst*, although the intervals that surround it are different in size (6 HC and 7 HC). Much in Arabian theories of the scale relies on prior knowledge of *maqām* rules and on former theorizations – see also next footnote.

At this point, it may be useful to explain how two intervals, which are different in size, can, according to Urmawī, be considered as identical conceptual intervals.<sup>53</sup>

The best example is with the *maqām Bayāt* (Fig. 4). It is based on the same scale as the *maqām Rāst*. The *Rāst* scale is composed of approximate three ‘one-tone’ and of four ‘three-quarter-tones’ intervals.

It could be notated as *c d e f g a b c*, with *e* and *b* being approximately one quarter-tone lower than their western equivalents. The scale of the *Bayāt* is close to the general structure of *maqām Rāst*, but begins with *d* and has a (generally descending)<sup>54</sup> *b<sup>flat</sup>*. This gives *d e f g a b c d*.<sup>55</sup>

The note *e* which has the same name in all theories of the *maqām*,<sup>56</sup> is placed differently according

<sup>53</sup> Conceptual intervals represent qualities of intervals when used in a melody or a scale. Compared one to another, each has a unique and identifying quality which relies on its relative size. These compose the fourth, the fifth or the octave, and play a distinct role in performance, bearing in mind fluctuations and regional preferences which will be stressed for the degree *SĪKĀ* in Arabian music for example, (Fig. 5, p. 14) and identified by the performer as a semi-tone, a *mujannab*, or a one-tone interval, and so forth. The Arabian usage of the HC agrees with the adepts of Pythagoras who insisted in the Pythagorean approximation of the Arabian scale, instead of an equal temperament. The reason is that the odd number of HC in one tone (nine) and its distribution among the Pythagorean *leimma* (4 HC – sometimes called ‘minor’ semi-tone) and the Pythagorean *apotome* (5 HC – sometimes called ‘major’ semi-tone) are good enough approximations and represent two different intervals whenever the *mujannab* intervals in Arabian music, conceptually equivalent to one and single interval, may also be approximated to two intervals of slightly different sizes, i.e., 6 HC and 7 HC, which, when added, equate to the augmented second of the Western scales. While Urmawī’s *mujannab* intervals could better be approximated with 8 HC (for the two-*leimmata mujannab*) and 5 HC (for the *apotome-mujannab* = *leimma* + *comma*), modern Arabian theoreticians need to differentiate the latter interval from the semi-tone, and stay close to the quarter-tone theory: this fact explains most of the inconsistencies and problems with the HC notation found in the literature.

<sup>54</sup> *Maqām Bayāt* ascending scale is often represented with the same structure as *maqām Rāst*, but beginning with *d*: the “normalizing” influence of the semi-tonal temperament (see [Beyhom, 2016]) has most probably precipitated an exclusive semi-tonal ascending and descending *b<sup>flat</sup>* found in recent theoretical literature (Fig. 4) – see [Beyhom, 2003c], Vol. 1, Part I.

<sup>55</sup> As noted above, elsewhere, *b<sup>flat</sup>* may be used for *b<sup>b</sup>*.

<sup>56</sup> Depending on the transliteration and, or, on local pronunciations: *SĪKĀ*, *SEGAH*, *SEH-GĀH*, etc.

to the context of the performance, or depending on the local repertoire (Fig. 5).<sup>57</sup>

Interval capacity is given in quarter-tones

↓ Rāst's ascending scale (one octave) ↓				Cumulative quarter-tones	Elementary quarter-tones	$d'$	Capacity	Conceptual intervals
Conceptual intervals	Capacity	$c'$	Elementary quarter-tones	Cumulative quarter-tones	24	4	4	Tone
Mujannab	3	$b^-$	3	24	23	3		
			2	23	22	2		
			1	22	21	1		
Mujannab	3	$a$	3	21	20	4	4	Tone
			2	20	19	3		
			1	19	18	2		
			1	18	17	1		
Tone	4	$g$	4	18	16	2	2	Semi-tone
			3	17	15	1		
			2	16	14	4		
			1	15	13	3		
Tone	4	$f$	4	14	12	2	4	Tone
			3	13	11	1		
			2	12	10	4		
			1	11	9	3		
Mujannab	3	$e^-$	3	10	8	2	3	Mujannab
			2	9	7	3		
			1	8	6	2		
			1	7	5	1		
Mujannab	3	$d$	3	7	4	1	3	Mujannab
			2	6	3	3		
			1	5	2	2		
			1	4	1	1		
Tone	4	$c$	4	4	↑ Bayāt's ascending scale (one octave) ↑			
			3	3				
			2	2				
			1	1				

Fig. 4 *Maqām Rāst* and *Bayāt* scales in the Modern quarter-tone theory.

In this *maqām*, the position of the degree  $SĪKĀ$ <sup>58</sup> ( $e^-$  in Western equivalence) has a lower pitch in Lebanese folk music than it has in Classical Arabian music in the Near-East. Should we decide to use a quarter-tone approximation for the intervals in Arabian music, as most modern theoreticians do, then the two zalzalian intervals between  $d$  and  $e^-$  and between  $e^-$  and  $f$  are

<sup>57</sup> The positions of the notes in the *maqām*, including the fundamental, may vary slightly during performance. See [Beyhom, 2006, p. 18–24], [2007a, p. 181–235] and [2016].

<sup>58</sup> I write note names fully capitalized, mode names with an initial capital letter and polychord (or *genus*) names with no capital letters, to differentiate for example the note  $SĪKĀ$  from the mode  $SĭkĀ$  and from the trichord  $sĭkĀ$  in Arabian music.

conceptualized as two three-quarter-tones intervals (Fig. 4). However, with the *Dal'ūna*, in *maqām Bayāt*, Near-Eastern folk music has a lower  $e^-$ , which, regardless, is considered as a  $SĪKĀ$ , but the lower interval between  $d$  and  $e^-$ , the lower *mujannab*, is smaller than an exact three-quarter-tone (Fig. 5), and the higher interval between  $e^-$  and  $f$  is larger.<sup>59</sup>

Furthermore, the positioning of the  $SĪKĀ$  depends on which *maqām* is played as well as region and repertoire. A good example is in the difference between the position of the  $SĪKĀ$  in the *maqām Bayāt* and the position of the same note in the *maqām Rāst* which in this case is higher in pitch, but lies approximately around the three-quarter-tone boundary.

In the *maqām SĭkĀ*,<sup>60</sup> or one of its frequent variants, the *maqām SĭkĀ-Huzām*,<sup>61</sup> the position of  $SĪKĀ$  is still higher and could sometimes reach the upper value of Urmawi's greater *mujannab*. This is the position assigned to this note in modern Turkish theory.<sup>62</sup>

The boundaries for these different positions for  $SĪKĀ$  are not established in practice, and the study of its variations would require another paper. This pitch is perceived as a  $SĪKĀ$  anywhere the player may perform. The difference is quantitative. However, the relative positioning of the note which is placed between  $e^b$  and  $e$ , will always be perceived as a  $SĪKĀ$ .

<sup>59</sup> This and the following explanations are based on the author's own experience while practicing Lebanese folk tunes, as well as on interval measurements of performance examples in various modes including the degree  $SĪKĀ$ ; on thorough discussions with teachers of Arabian music (mainly on the *ūd*), and also on an extensive and systematic study of contemporary *maqām* theories in the Near- and Middle-East. For the latter see for instance [Beyhom, 2003c].

<sup>60</sup> The mode  $SĭkĀ$  traditionally begins with the note  $SĪKĀ$ .

<sup>61</sup> The two are commonly used both with Classical and Folk Arabian music in the Near-East.

<sup>62</sup> [Signell, 2002]. Turkish (classical) modern theory uses the HC approximation for its intervals. In practice, however, as Signell stresses (p. 37-47) and the way in which many contemporary Turkish musicians perform (as underlined for Kudsi Erguner on *Nāy* or for Fikret Karakaya on the *Lyra* in [Beyhom, 2006 ; 2016]), the note  $SĪKĀ$  tends to be played lower than its assigned value (that is  $e$  minus one comma in Turkish theory), notably in *maqām Rāst*, *Şabā* and *Bayāt*.

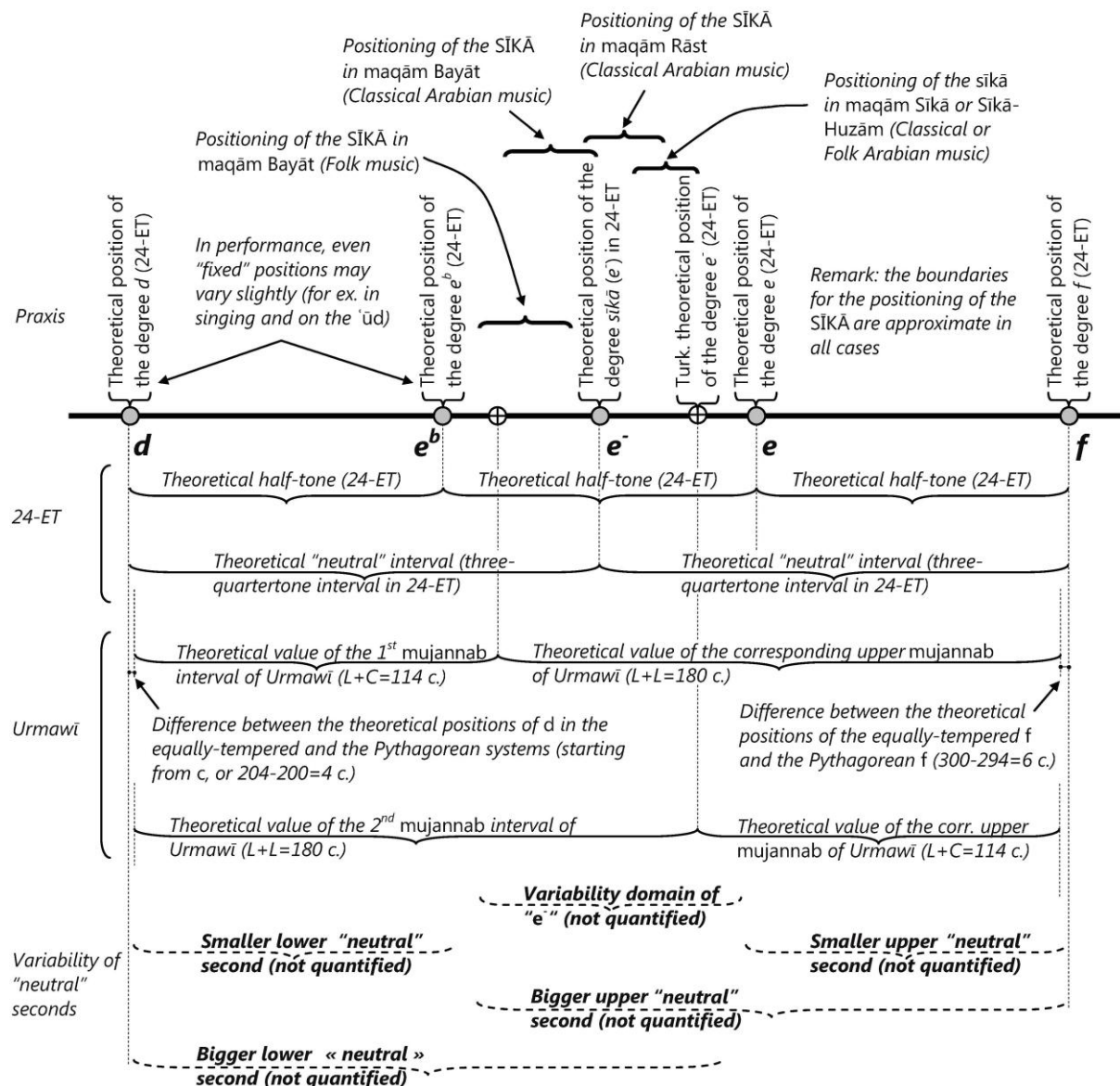

Fig. 5 Repertoire or regional variations of SĪKĀ and of the zalzalian seconds – this emended figure is taken from [Beyhom, 2016].

Therefore, the conceptual understanding of the zalzalian second is not simply quantitative, but also relative and qualitative.<sup>63</sup>

<sup>63</sup> The difference between the mobile notes of Ancient Greek theory and the variable position of the single note SĪKĀ lies in the fact that mobile notes may move from one position to another in the general scale, whilst the variability of the degree SĪKĀ, for example, involves only one position in the general scale, which varies. An example of mobility is a change from pitch *e* to pitch *e<sup>b</sup>*, when a minor tetrachord *d e f g* modulates into a *Kurd* tetrachord (or also as the introductory tetrachord in the flamenco scale, starting with *d: d e<sup>b</sup> f g*), while the position of SĪKĀ may vary depending on a certain number of factors, but its relative

Importantly, the *mujannab* is perceived as an intermediate interval between the one ‘half-tone’ and the ‘one-tone’ intervals. This applies for all other intervals such as the semi-tone which is an interval smaller than the *mujannab*, and to the ‘one-tone’ interval which is larger than the latter. The tonometric value of *mujannab*

→ positioning in the scale remains the same (it is still considered as the same intermediate – and identified – pitch between *e<sup>b</sup>* and *e*, or *e<sup>-</sup>*), and the intervals it delimitates are identified, in the *maqām Rāst*, *Sīkā* and *Bayāt* scales, as *mujannab* intervals.

may vary,<sup>64</sup> but it is the relative position of the interval in the scale and its qualitative and relative size, compared to other conceptual intervals, which gives it its full value in the repertoire.

To conclude on the nature of intervals in a scale, they are of three types<sup>65</sup>:

1. An interval of measurement is an exact (or nearly exact) divider of other intervals. As a general rule, any musical system based on the equal division of the octave, as in an equal temperament, gives an interval of measurement, such as the semi-tone in the 12-ET, and with the quarter-tone in the 24-ET or the HC in the 53-ET divisions of the octave.
2. Conceptual interval. This is one of the consecutive intervals of the second forming a musical system. For example, three seconds in a just fourth, four seconds in a just fifth, or seven seconds in an octave. Conceptual intervals can be measured either exactly or approximately with smaller intervals, usually of measurement, as in approximations using the quarter-tone or the HC.
3. Elementary intervals are used in combination to build up to consecutive conceptual intervals of seconds within a system. They can combine either with a similar elementary interval, such as with the two *leimmata* in Urmawī's general scale, which combine into a *mujannab* interval, or with another elementary interval, such as the *leimma* + *comma*, for the second form of the *mujannab*, with Urmawī.<sup>66</sup>

These three types of intervals are not mutually exclusive. When the smallest conceptual interval is also the smallest common denominator of all conceptual intervals, as with the semi-tone in the 12-ET, then it becomes an interval of measurement, but it is also an elementary interval, although it remains conceptual when used as an interval of second within a musical system. The need to differentiate these three types of

intervals arises within unequal temperaments, for example with Urmawī.<sup>67</sup>

This distinction will provide with a better understanding of the combination processes applied to music intervals.

#### APPLYING THE CONCEPT OF QUALITATIVE DIFFERENTIATION OF INTERVALS ON URMAWĪ'S SCALE

Urmawī's explanations about his scale show that the ("major", Pythagorean) tone is composed of three elementary intervals and that no interval within the fourth may contain either three successive *leimmata* or any two successive *commata* (Fig. 6).

The *comma* is neither a quantifying interval as it does not divide exactly other intervals such as the *mujannab* or the tone,<sup>68</sup> nor is it a conceptual interval, as it is never used as a melodic interval between two pitches in a modal scale.<sup>69</sup> Furthermore, a *comma* is never used as the first interval of a combination, with a notable exception for the *mujannab* which can hold the form 'C+L'.

A conceptual interval generally starts with itself or with another conceptual interval. The *leimma*, for example, is used both as a conceptual interval, the smallest interval used in any of Urmawī's modal scales and as an elementary interval used in the composition of other, relatively larger, conceptual intervals.

With Urmawī, both the *comma* and the *leimma*, are elementary intervals. However and additionally, the *leimma* is also a conceptual interval.

<sup>67</sup> The urge for such a concept is even more evident with music not responding, partially or completely, to temperament, such as we have with traditional *a capella* singing worldwide.

<sup>68</sup> At least in Urmawī's concept of the scale: it is much later in the history of music theory that some theoreticians began using the Holderian comma as a measuring interval for approximating Pythagorean intervals, but this can not apply to theoreticians of the Western "Middle Ages" who dealt mainly with Pythagorean frequency (or string) ratios for interval handling – see [Beyhom, 2016].

<sup>69</sup> This means that a melody would not, in the modal or *maqām* music described in Urmawī's theories, move directly from one pitch to another, one *comma* apart, unless this process is used in performance as an intonation variation within the original melody (in which case the size of the *comma* is approximate). This is still the case with Arabian music, but where the quarter-tone is the elementary interval of the 24-ET – see the example of *maqām Awj-Āra* in Part II and footnote 147.

<sup>64</sup> For example "the *SĪKĀ* in Lebanese Folk music is lower than the *SĪKĀ* in...".

<sup>65</sup> To which we can add the Container (or Containing) intervals.

<sup>66</sup> Additionally, the Pythagorean *comma* is an *auxiliary interval*, i.e. an interval which is neither a *measuring interval*, nor *conceptual*.



follow each other,<sup>71</sup> and b) the *comma* must always be preceded or followed by a *leimma*. In this case, the tone can only include two *leimmata* and one *comma*, with two possible arrangements: L+L+C, or L+C+L.

4. The greater, or augmented conceptual interval of the tone is composed of four elementary intervals. It can only be made up of three *leimmata* and one *comma*. They can only be arranged in this manner: L+L+C+L or L+C+L+L. This interval is not mentioned in the *Book of Cycles*. It is only assumed as part of Urmawī's seconds.
5. The greatest conceptual interval of the second is made up of 5 elementary intervals because the fourth can only be composed of a maximum of seven elementary intervals, within the systematic<sup>72</sup> general scale. However, two other intervals of second (conceptual interval) are needed for its completion. Since the smallest second is the semi-tone, the *leimma*, the greatest conceptual interval is equal to the remainder coming from the subtraction of two *leimmata* from the fourth. The fourth is composed of two tones and one semi-tone, *i.e.*,  $[2 \times (2L+C)] + L$ , or  $5L+2C$ . Taking away two *leimmata*, the resulting capacity of the greatest conceptual interval in a fourth is  $3L+2C$ . Applying the rules of construction of the intervals, such as no more than two *leimmata* in a row, etc., the possible forms of the greatest second, or tone, in Urmawī-type scales are L+L+C+L+C, or L+C+L+L+C. This interval is not mentioned as such in the *Book of Cycles* but is also assumed.

The fourth needs a combination of smaller intervals so that their sum can add up to its capacity in terms of elementary intervals. In order to simplify the process, I

shall use a simple handling of numbers equating to the conceptual intervals of the second with Urmawī.<sup>73</sup>

1. The semi-tone equals number 1, as one elementary interval is needed to compose this conceptual interval.
2. The *mujannab* is given the value of 2 since two elementary intervals are needed to build it up to a conceptual interval.
3. The tone interval is given the value of 3 since it needs three elementary intervals.
4. The Greater tone has the value of 4 since it requires four elementary intervals.
5. The greatest interval of the second within a fourth has the value of 5 because it needs five elementary intervals.

Although having a quantitative function in terms of numbers of elementary intervals which make up a conceptual interval, numbers 1 to 5 express the intrinsic quality of the interval: its (theoretical) identification as a different conceptual interval from those represented with another number. As a common rule, the fourth is made up of three conceptual intervals. In order to comply with Urmawī, they must add up to seven elementary intervals.

Reduced to their hyper-systems, we have the following:

1. 115, with  $1+1+5 = 7$  (not in Urmawī's *Book of cycles*)
2. 124, with  $1+2+4 = 7$  (not in Urmawī's *Book of cycles*)
3. 133, with  $1+3+3 = 7$
4. 223, with  $2+2+3 = 7$

Therefore, in this case, a fourth may contain, either 1) two semi-tones, '1', and one greatest interval of second, '5', or 2) one semi-tone, one *mujannab*, or zalzalian tone, '2', and one augmented, or greater tone, '4', or 3) one semi-tone and two intervals of one tone, '3', or 4) two *mujannab*, or zalzalian tones and one one-tone interval.

The algorithm for these hyper-systems is straight forward (Fig. 7):

<sup>71</sup> Because three small intervals are necessarily bigger than a *mujannab*, which means that their sum must necessarily be equal to the one-tone Pythagorean interval, which stands next in the row of conceptual intervals.

<sup>72</sup> The "Systematist scale" is the name given to Urmawī's scale by Western musicologists, and his followers are known as the "Systematists".

<sup>73</sup> One could also use corresponding letters, for example S, M, T, etc., for the combination process: numbers have the same discriminating power, but have the advantage of allowing a quick check of the sum of the elementary intervals in the series.

1. To find the first hyper-system, (Fig. 7, first step) take the smallest conceptual interval, 1 twice in this case, and then deduce the value of the third interval by subtracting the quantitative value of the first two, which adds up to 2 elementary intervals, from the value of a fourth, or 7 elementary intervals, which gives 5.
2. The second hyper-system, the 124 hyper-system above, is obtained by decrementing the value of the last digit interval in the preceding first hyper-system, (Fig. 7, second step) and by incrementing accordingly the value of the interval standing just before in the series: the last digit in the first hyper-system is 5, which is decremented to 4, and the interval which precedes it, which is the central 1 in the 115 hyper-system, is incremented, accordingly, to 2.
3. The simultaneous decreasing of one interval value by one unit, or its decrementation, with the increasing of one other interval value by the same unit of one, or accordingly incrementing it, insures that the sum of the numbers in the series remains unchanged. Here it is equal to 7.
4. Applying the same process to the resulting hyper-system 124, (Fig. 7, second step — repeated) the third hyper-system is now 133.
5. Applying the same process to this last hyper-system would result in 142.

The capacity of the last series is, however, the same as for 124. The reason is that in the preceding 133, the last two intervals were equal but with the continuation of the process in the same way, interval values for the central ‘3’ are the same as the preceding values for the last ‘3’, *i.e.*, 4 and 5, and reciprocally, which would result in the same composition of intervals, in terms of quantity, within the fourth.<sup>74</sup>

At this point, we need to improve the algorithm in order to find the remaining hyper-systems. This is done by decreasing the rank of the intervals to be modified by applying the same process to the interval the rank of which is immediately below the rank of the interval to which the decrementing process was last applied, *i.e.*, 133. The latter is the third interval in the series

and now we must decrement the second interval in the series, and increment, accordingly, the preceding one, the first interval in the same series.

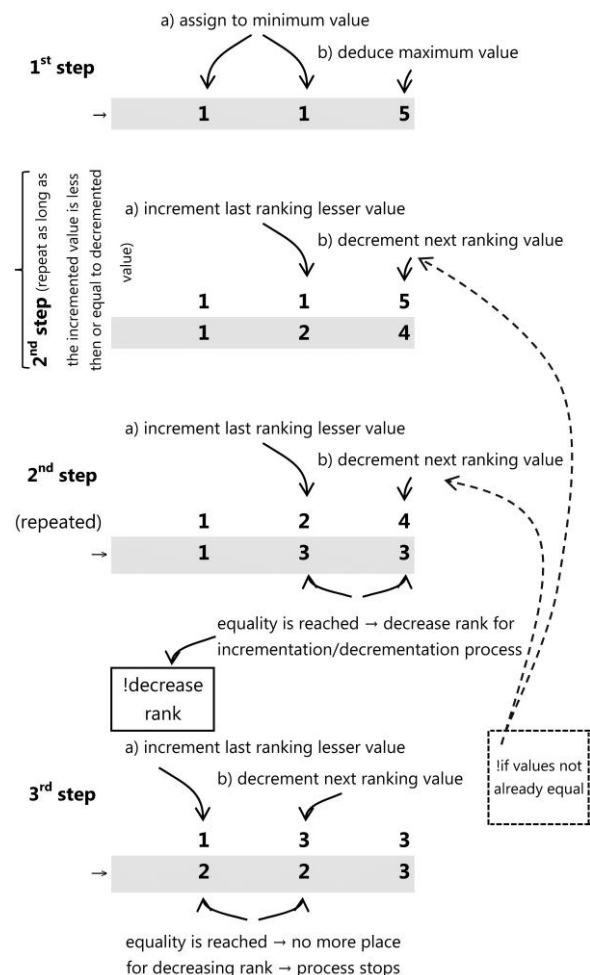

Fig. 7 An algorithm for hyper-systems.

Applying this process to 133 which we found in the preceding step, the second interval, central 3 (Fig. 7, 3<sup>rd</sup> step) is decremented to 2, and the first interval, 1, is incremented to 2 (as well), whilst the third interval, which is the last 3, remains unchanged. This gives the new figure of 223. This is where the generation process ends since the two first intervals have now similar values. Any further step would generate a redundant hyper-system.<sup>75</sup>

<sup>75</sup> This simple algorithm is used for computer combination processing and is very efficient for larger interval series as, for example, a heptatonic scale: it is applied in a more elaborate formulation in the generative procedures used by the theory of Modal systematics, which allow a complete survey of hyper-systems, systems and sub-systems as they shall be defined below.

Now that we have determined the hyper-systems agreeing with Urmawī, we need extract all possible tetrachords and shades to give the full range of intervals in the fourth. The next section will review combination processes of intervals, for any hyper-system.

### Various forms of interval combination

There are different methods for combining intervals. One is the rotation and the other the permutation process.<sup>76</sup> These are the most common. Rotation was used, notably, by Aristoxenos in his *Elements of Harmonics*,<sup>77</sup> and permutations were often used throughout history, and most probably by Fārābī in his tetrachords, adding to Aristoxenos' range of tetrachords.<sup>78</sup> Both processes are deficient since they do not give, in their simplest expression, a full account of all the possible combinations. The tree process given below has the whole range of results. However, this is more related to statistical and probabilistic analyses.

There are other procedures, such as de-ranking, which can be considered as a general case of the Byzantine-wheel method. Modal systematics uses them all for the purpose of arranging and classification, with special recourse of the de-ranking process.

#### ROTATION OF INTERVALS

Rotation (Fig. 8) is a straight forward process by which intervals may be combined, placing the first after the last one, or inversely, the last before the first, leaving the other intervals in their position.

<sup>76</sup> The permutation process(es) are explored in Appendix H.

<sup>77</sup> English translation in [Aristoxenos and Macran, 1902; Barbera, 1984], aforementioned.

<sup>78</sup> The additional tetrachords of Fārābī are what I call the *zalzalian* tones tetrachord (which is equivalent to the Arabian *bayātī*), and the original equal-tones tetrachord: expressed in multiples of quarter-tones, the first genus can be represented by 3 3 4, or three-quarter-tones, three-quarter-tones, and one one-tone, intervals. In its essence, it is equivalent to the equal diatonic (ascending) tetrachord of Ptolemaos with successive string ratios of 11/12, 10/11 and 9/10. For a general survey of Greek genera, see [Barbera, 1977], notably p. 296, 298, 302, 303, 307, and [Mathiesen, 1999], p. 468-75. The second addition of Fārābī, the equal-division tetrachord (or equal-tone division of the tetrachord), is composed of three identical intervals each of which has a size of 5/6 tone (see [Fārābī (al-), 1930, v. 1, p. 58-59], and Appendix 3 in [Beyhom, 2016]).

The first method is a clockwise process which continues as long as the first interval does not come back to its initial position, obviously. Fig. 8 shows that this process generates intervals in three different ways (the first does not rotate since it places the interval system in its original and basic position).

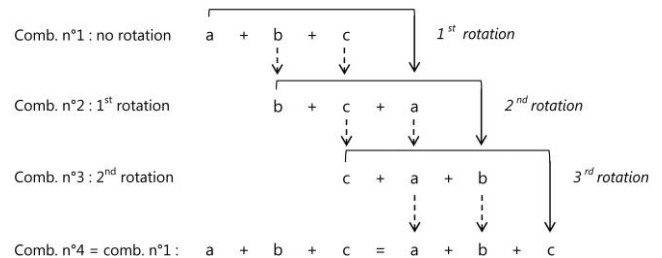

Fig. 8 Rotation of three distinct intervals a, b and c with the three resulting combinations.

However, the rotation process is defective, as it always gives three possible combinations of three intervals, whenever the combination possibilities for these three intervals allows for six different combinations.<sup>79</sup> For the purpose of his explanation, Aristoxenos used intervals of the enharmonic tetrachord which are made up of two quarter-tones and one ditone, that is two equal intervals out of three.

Fig. 9 shows intervals with subscript numbers so that they retain their initial rank in the basic configuration, that is  $a_1$  as the first interval of the basic configuration,  $a_2$  as the second and  $b_3$ , as the third.

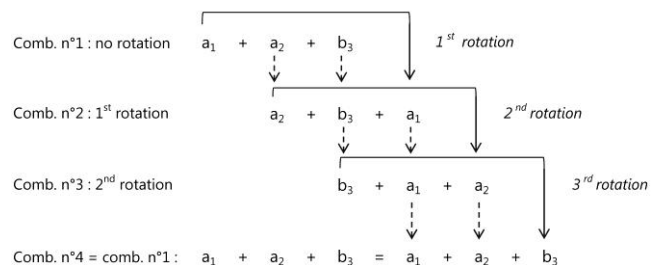

Fig. 9 Rotation of three intervals out of which two (the 'a' intervals) can be considered as equivalent (the subscript numbers identify the initial rank of each interval in the original – basic – combination): the outcome is still three distinct combinations.

<sup>79</sup> The total number of combinations is obtained through the formula  $N!$  (or  $N$  factorial), in which  $N$  is the number of intervals to combine. Here, we have  $3!$  (or three factorial) which is equal to  $3 \times 2 \times 1 = 6$ . On the other hand, any rotation (or, here, combination of three identical intervals would give the same redundant combination, like in a a, for example.

Even then, the rotation process gives three distinct combinations. If the three intervals are equal to Fārābī’s equal-tone distribution where each is 5/6 of a tone, a combination process, whatever it may be, will always give the same result as combining the three intervals a a a.

Other processes are more effective but Aristoxenos’ use of this limited process might have been a consequence that he considered interval combination as a de-ranking process.

TREE PROCESSING<sup>80</sup>

In the tree processing the combinations are based on an initial choice of intervals, rank by rank (Fig. 10).

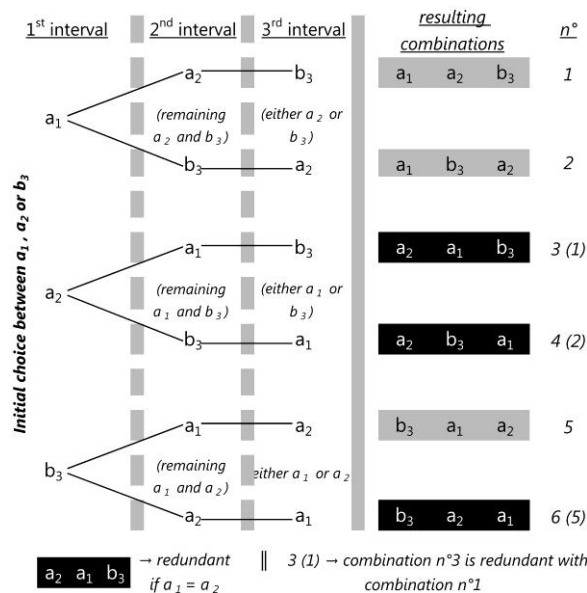

Fig. 10 Tree processing for three intervals.<sup>81</sup>

With the first rank, we may choose between the three intervals a<sub>1</sub>, a<sub>2</sub>, or b<sub>3</sub> (the subscript plays here more the role of identifier for each interval, than the role of an initial rank number).

Having completed this first step, we still have two intervals of which one must be assigned to the second position in the series. The third step leaves us with one

possibility since two out of three intervals have already been used.

The process is straightforward as it gives directly the six distinct combinations seen above. There are no redundancies although intervals a<sub>1</sub> and a<sub>2</sub> could be taken as equal. In this case, again, we only have three distinct combinations.

The tree processing method is rarely used for combination of intervals and this is one of the reasons why we have to explore further the de-ranking process which is of crucial importance in Modal systematics<sup>82</sup> as it is a practical way for arranging and classifying large numbers of interval combinations, such as in the heptatonic scales.

THE DE-RANKING PROCESS, OR PICKING INTERVALS ‘N’ IN A ROW OUT OF REPEATED SERIES OF ‘M’ CONJUNCT INTERVALS – HYPER-SYSTEMS, SYSTEMS, AND SUB-SYSTEMS

De-ranking is closely related to rotation. It is very useful and in the study of musical systems applies mostly to the double octave. In a reduced form, the de-ranking process takes it that a series of conjunct intervals is repeated a certain number of times, for example for in the series a<sub>1</sub> a<sub>2</sub> b<sub>3</sub> a<sub>1</sub> a<sub>2</sub> b<sub>3</sub> a<sub>1</sub> a<sub>2</sub> b<sub>3</sub>...<sup>83</sup>

By de-ranking the first interval, we start the series of intervals by the first interval a<sub>2</sub> instead of the first interval a<sub>1</sub>. We may consider this process as a rotation of intervals where the first a<sub>1</sub> goes to the end of the extended series. If we choose N intervals out of a repeated pattern of N intervals, this process is a repeated rotation<sup>84</sup> where N = M = 3. (Fig. 11)

In a more general application of this process, N intervals in a row are taken out of a series of M, repeated at least once, with both N and M being integer numbers. In the case of five intervals a b c d e repeated once in a row, for example (Fig. 12), we can pick up any series of three conjunct intervals to form a combination. The first ranking combination is a b c, the second b c d, the third c d e, etc.

<sup>80</sup> This process is used in statistical and probability algorithmic, which is historically a recent domain in science. Reminder: the permutation processes, combined with rotations, are explained in Appendix H.

<sup>81</sup> See previous figure: the outcome is 6 distinct combinations as in the rotation/permutation procedure (see Appendix H), but the result is straight forward; however, if ‘a<sub>1</sub>’ and ‘a<sub>2</sub>’ be considered as identical, there would remain only three distinct combinations out of six possibilities.

<sup>82</sup> And for music theory as a whole.

<sup>83</sup> This process is called the Wheel by Byzantine chant theoreticians. It is applied to intervals composing a fifth repeated in a row. See [Giannelos, 1996, p. 89], “Le système de la roue”, and [Beyhom, 2015a].

<sup>84</sup> In which case the procedure is called “calibrated de-ranking”.

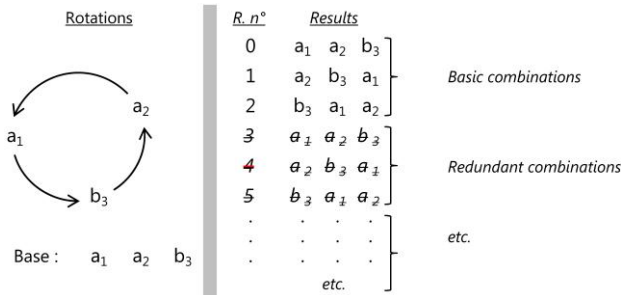

Fig. 11 Endless rotations of intervals as a particular case of the de-ranking procedure.<sup>85</sup>

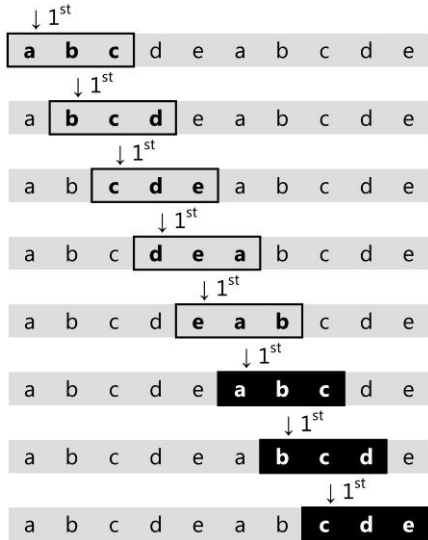

Fig. 12 De-ranking procedure applied to three successive intervals picked out from a double row of five intervals.<sup>86</sup>

If we apply this process to a double heptatonic tense diatonic (ditonic) scale,<sup>87</sup> and in turn select seven conjunct intervals among the fourteen of the series (Fig. 13), beginning with the first interval, the second, the third, etc., and until the seventh, we obtain the seven different species of the scale<sup>88</sup>.

In Fig. 13 the basic scale is 1 2 2 1 2 2 2, in which intervals are expressed as multiples of the semi-tone.

This corresponds to the ditonic, and here also, the equal temperament Western scale beginning with B or its equivalents (b, b', etc.), or B 1 (semi-tone) c 2 d 2 e

<sup>85</sup> By picking three (N) conjunct intervals, out of three ('M=N') endlessly repeated intervals, beginning with the first, then the second, etc., we end up applying a rotational procedure with, as a result, an endless series of redundant combinations.

<sup>86</sup> There are five distinct combinations out of eight, the last three being redundant with the first three.

<sup>87</sup> Starting here with B, for reasons explained farther.

<sup>88</sup> Which are named sub-systems in the theory of Modal systematics.

1 f 2 g 2 a 2 (b). Of all possible species of the double ditonic octave, this scale corresponds to the lowest value when expressing the concatenated intervals as an integer number.

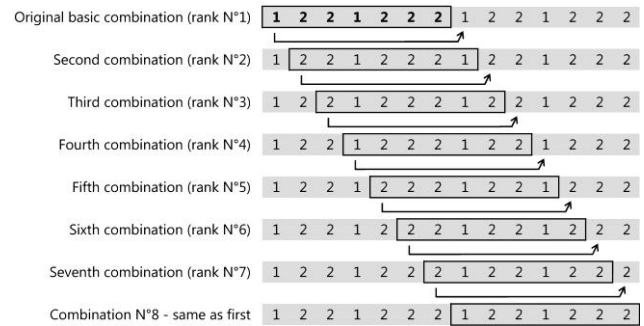

Fig. 13 Calibrated<sup>89</sup> de-ranking procedure applied to two identically composed octaves in a row.<sup>90</sup>

With modal systematics, the first in a series of de-ranked combinations is considered as the basic system.<sup>91</sup> The others, in this example, are sub-systems of system 1 2 2 1 2 2 2 (Fig. 14).

(Hyper-system is 1 1 2 2 2 2 2)	Rank of the sub-system	Beginning note (West.)	Intervals in multiples of the semi-tone
(Basic system has rank N°1)	1.	B	1 2 2 1 2 2 2
The seven sub-systems (including the basic system) extracted (by a de-ranking process) from basic system 1221222	2.	c	2 2 1 2 2 2 1
	3.	d	2 1 2 2 2 1 2
	4.	e	1 2 2 2 1 2 2
	5.	f	2 2 2 1 2 2 1
	6.	g	2 2 1 2 2 1 2
	7.	a	2 1 2 2 1 2 2

Fig. 14 Results of the de-ranking procedure as applied in Modal systematics to the Western ditonic scale.<sup>92</sup>

<sup>89</sup> I use "calibrated" to characterize de-ranking when it is similar to rotation – see footnote no. 84.

<sup>90</sup> Seven species (or sub-systems in the theory of Modal systematics) may be extracted through the procedure – see also footnote no. 87. Calibrated de-ranking only will be used through the remaining part of the article, and shall simply be called "de-ranking process" or "de-ranking".

<sup>91</sup> Together as the first sub-system of the series.

<sup>92</sup> The sub-system having the smallest figure as a whole number (as an integer concatenated form), is sub-system 1 2 2 1 2 2 2 (in concatenated form 1221222, or 'one million two hundred and twenty one thousands and two hundred twenty-two'). All other sub-systems have a corresponding integer value which, if their intervals be concatenated to form an integer number, is larger than the former. Consequently, in modal systematics, the combination 1 2 2 1 2 2 2 holds the head rank among these 7 sub-systems and is considered as being the basic system from which the six others are deduced by the de-ranking procedure (the basic system is, besides being the head or base system, the first sub-system in the group of seven). The capacity indicator of these sub-systems is hyper-system 1 1 2 2 2 2 2 (two one-semi-tone and five one-tone intervals).

The hyper-system is the interval capacity indicator that we find in arranging all intervals in a combination from the smallest to the largest. For example, in the hyper-system 1 1 2 2 2 2 2, from which we get that the capacity of all corresponding systems and sub-systems is equivalent to two one-semi-tone intervals and five one-tone intervals, there are other systems which are distinct from 1 2 2 1 2 2 2. They have the same capacity, within the same hyper-system.

In order to find all systems and sub-systems originating from a hyper-system, one needs apply, for example, a combined process of rotations/permutations to its intervals.<sup>93</sup> This has been explained above.<sup>94</sup> If we eliminate the redundant systems or sub-systems, we find (Fig. 15) two other systems for hyper-system 1 1 2 2 2 2 2.

The first of these two distinct systems is the hyper-system itself, as it expresses an arrangement of intervals 1 1 2 2 2 2 2, where the two semi-tones in the first combination are placed in a row, and which is different from 1 2 2 1 2 2 2. This system has in turn seven sub-systems. In this case, they are species.

The remaining system which has the same interval capacity as the precedent ones but whose intervals are arranged following a different pattern where two semi-tones are separated alternately by one, then four, one-tone intervals, is 1 2 1 2 2 2 2, and has, accordingly, seven distinct sub-systems. Fig. 15 shows how hyper-system 1 1 2 2 2 2 2 has intervals that can be combined in three distinct systems which in turn, give each seven different combinations or sub-systems obtained from de-ranking.

This hyper-system is peculiar in that it is the only one composed exclusively of one ‘semi-tone’ or one ‘tone’ intervals. If to our alphabet of intervals, we add the ‘one-and-a-half-tones’ interval class in our model, we find two other hyper-systems, 1 1 1 1 2 3 3 and 1 1 1 2 2 2 3.

Rank of the sub-system		Intervals in multiples of the semi-tone							
Hyper-system: 1 1 2 2 2 2 2	System N°1: 1 1 2 2 2 2 2	1.	1	1	2	2	2	2	2
	2.	1	2	2	2	2	2	1	
	3.	2	2	2	2	2	1	1	
	4.	2	2	2	2	1	1	2	
	5.	2	2	2	1	1	2	2	
	6.	2	2	1	1	2	2	2	
	7.	2	1	1	2	2	2	2	
System N°2: 1 2 1 2 2 2 2	1.	1	2	1	2	2	2	2	
2.	2	1	2	2	2	2	1		
3.	1	2	2	2	2	1	2		
4.	2	2	2	2	1	2	1		
5.	2	2	2	1	2	1	2		
6.	2	2	1	2	1	2	2		
7.	2	1	2	1	2	2	2		
System N°3: 1 2 2 1 2 2 2	Beginning note (West.)	1.	B	1	2	2	1	2	2
2.	c	2	2	1	2	2	2	1	
3.	d	2	1	2	2	2	1	2	
4.	e	1	2	2	2	1	2	2	
5.	f	2	2	2	1	2	2	1	
6.	g	2	2	1	2	2	1	2	
7.	a	2	1	2	2	1	2	2	

Fig. 15 Complete listing of the systems and sub-systems related to hyper-system 1 1 2 2 2 2 2 (in multiples of the half-tone).<sup>95</sup>

These generate 15 and 20 distinct systems, respectively, or 105 and 140 distinct sub-systems. They are too numerous to be listed here, but an example of sub-system from the first hyper-system is the (Modern)<sup>96</sup> scale of the well-known *Hijāz-Kār* Arabian mode, with two *hijāz* tetrachords (1 3 1),<sup>97</sup> separated by a one-tone interval: 1 3 1 [2] 1 3 1.<sup>98</sup>

<sup>95</sup> Three systems are generated, one of which applies to the western regular scale (semi-tonal ditonic – or simply “ditonic”). The other two scale systems (or seven sub-systems for each system) are rarely used but are found in the specialized literature and used in contemporary music (see [Beyhom, 2003b, p. 48–50] for more details). See Slide no. 20 in the accompanying Power Point show to listen to the scales.

<sup>96</sup> i.e. semi-tonal following the influence of the semi-tonal piano.

<sup>97</sup> Or one semi-tone, one tone and a half, one semi-tone: this tetrachord is equivalent to the tonic chromatic tetrachord of Aristoxenos, with the semi-tones placed on both sides of the one-and-a-half-tones interval.

<sup>98</sup> This mode is also frequently assigned to European gypsy music, and also used with film music, notably the score by Maurice Jarre for *Lawrence of Arabia* (dir. David Lean, 1962 – see [Anon. “Lawrence of Arabia (film)”, 2016]); more about *hijāz*-type tetrachords can be found in [Beyhom, 2014].

Another example, related to the second hyper-system, is the scale of the contemporary Arabian *maqām Ḥijāz*, which commonly follows the scale 1 3 1 2 1 2 2 when reduced to a semi-tone scale without zalzalian intervals.

Now if we wanted to express the intervals of these hyper-systems in the equal-quarter-tones distribution of modern Arabian theory, then this would give:

1. 2 2 4 4 4 4 4<sup>99</sup>
2. 2 2 2 4 4 4 6
3. 2 2 2 2 4 6 6

If arranged in agreement with modal systematics classification, with the lesser values of hyper-systems holding the lower rank, their places would be reversed as:

1. 2 2 2 2 4 6 6
2. 2 2 2 4 4 4 6
3. 2 2 4 4 4 4 4

Let us now take in consideration the two zalzalian intervals used in modern Arabian theory. These are the three-quarter-tone ‘3’ and the five-quarter-tone ‘5’ intervals, which are conceptually differentiated from the one-semi-tone, one-tone, and one-tone-and-a-half. Combining the five intervals 2, 3, 4, 5, and 6 in seven possible positions, with the condition that the sum of the intervals must be equal to 24 quarter-tones, we end up having 19 hyper-systems (Table 4: 24) with a possible number of 4795 sub-systems or scales. Among them, there are very few in usage.

Scales used in semi-tone hyper-systems such as hyper-systems nos. 1, 6 and 12 in the table, are limited to the ditonic and to the (“Modern”, *i.e.* westernized) *Ḥijāz-Kār* or *Ḥijāz* type scales.

For the remaining hyper-systems, scales used in the performance, practice and theory of Arabian, Persian and Turkish<sup>100</sup> music are remarkably few. These are no more than 150 to 200 which, when compared to the possible number of 4975, or out of more than eight thousand possible sub-systems with the extended

alphabet<sup>101</sup>, as we shall see in Part II, raises questions about the criteria differentiating these scales from others.<sup>102</sup>

Some preliminary remarks on the systems and sub-systems of the quarter-tone generative model can already here be expressed:

Homogeneity of interval composition within a hyper-system results in a lesser number of systems because of the redundancy factor. The less the interval contains different classes of intervals (for example with hyper-system no. 12, which contains only two classes of intervals, the 2 and the 4), the less it generates systems and, consequently, sub-systems.<sup>103</sup>

<sup>101</sup> *i.e.* with intervals greater than the one-and-a-half-tones – see Appendix J (downloadable at <http://nemo-online.org/articles>) with reproduces the raw results for *systems*: sub-systems can be deduced by de-ranking.

<sup>102</sup> The main question arising here is why, out of this great number of potential scales, traditional music around the world would use only a few? A first answer to this question was given in [Beyhom, 2003c], in which some of the criteria suitable to scale systems in order to verify if they correspond to musical practice as we know it are identified, such as the presence of a fourth or fifth from the tonic, and/or the absence of particular scale combinations (such as combining two large intervals in a row, or more than two semi-tones in a row, etc.). Applying these conditions, as well as others, to the scales of the quarter-tone generation which can be made up, we can get close enough to the configuration of scales used today, particularly in Arabian music. Exceptions to the main hyper-systems can be dealt with separately, and will give valuable information about this particular music, and, of others, and the additional criteria applying to it. Note that traditional pre-*Congrès du Caire* of 1932 (see [Anon. “Cairo Congress of Arab Music”, 2016]) Arabian music used other scales still (mainly in connection with the Old *ḥijāz* and *ḥijāz-kār* tetrachords – see [Beyhom, 2014]) that today are mostly lost, notably because of the influence of Western music and theory.

<sup>103</sup> There is a relatively simple empirical formula for the calculation of the number of systems which can be generated by a hyper-system provided that the total Number of Intervals in one hyper-system is NI intervals, and that different classes of intervals contained in the hyper-system have a capacity Oi (each interval i is reproduced Oi times in the hyper-system), the number of distinct permutations of intervals within the hyper-system is equal to (NI!)/(O1! x O2! x O3! etc.). In the case of hyper-system no. 12, interval 2 occurs five times, and interval 4 twice, by replacing in the formula we obtain the number of distinct sub-systems or [(7!)/(5! x 2!)] = [5040/(120 x 2)] = 21. The structure of the formula explains why homogeneity of the conceptual intervals composing a hyper-system, is a factor that lessens the number of resulting (non-redundant) sub-systems.

<sup>99</sup> This is the most homogeneous system among the three, with only two different classes of intervals used.

<sup>100</sup> In the case of the latter music, scales are notated differently but are conceived as being the same as Arabian corresponding scales. This is too lengthy a subject to be treated here, but the reader can have more information in [Beyhom, 2006 ; 2014 ; 2016].

H.	Value	NS	NSS	NSS4	FF	Remarks
1	2 2 2 2 4 6 6	15	105	58	21	<i>Ḥijāz-Kār</i> , “Arabian”, “Gipsy” or “chromatic” scales
2	2 2 2 2 5 5 6	15	105	23	6	<i>Very rare: existence not confirmed as (5 2 2 6 2 5 2)</i>
3	2 2 2 3 3 6 6	30	210	54	0	<i>Rare: existence confirmed as (3 3 2 6 2 6 2)</i>
4	2 2 2 3 4 5 6	120	840	208	60	Variants of N°1
5	2 2 2 3 5 5 5	20	140	56	12	<i>Existence not confirmed to this day</i>
6	2 2 2 4 4 4 6	20	140	80	46	<b>Frequent: generates Ḥijāz (2 6 2 4 2 4 4)</b>
7	2 2 2 4 4 5 5	30	210	40	14	<i>Existence not confirmed to this day</i>
8	2 2 3 3 3 5 6	60	420	120	0	<i>Existence not confirmed to this day</i>
9	2 2 3 3 4 4 6	90	630	168	54	<b>“Regular” Ṣabā (3 3 2 6 2 4 4) and other modes</b>
10	2 2 3 3 4 5 5	90	630	210	54	Variants of N°1
11	2 2 3 4 4 4 5	60	420	96	36	Variants of N°6
12	<u>2 2 4 4 4 4 4</u>	<u>3</u>	<u>21</u>	<u>12</u>	<u>9</u>	<b><u>Semi-tonal “diatonism” and derivatives</u></b>
13	2 3 3 3 3 4 6	30	210	46	0	<i>Existence not confirmed to this day</i>
14	2 3 3 3 3 5 5	15	105	29	0	<i>Existence not confirmed to this day</i>
15	2 3 3 3 4 4 5	60	420	120	36	Scales are close to those of N°6
16	<u>2 3 3 4 4 4 4</u>	<u>15</u>	<u>105</u>	<u>30</u>	<u>18</u>	<b><u>Frequent: Arabian Bayāt and other modes</u></b>
17	3 3 3 3 3 3 6	1	7	0	0	<i>Existence not confirmed to this day</i>
18	3 3 3 3 3 4 5	6	42	12	0	<i>Existence not confirmed to this day</i>
19	<u>3 3 3 3 4 4 4</u>	<u>5</u>	<u>35</u>	<u>18</u>	<u>9</u>	<b><u>Frequent: Arabian Rāst and other modes</u></b>
<b>Total</b>	<b><u>19</u></b>	<b><u>685</u></b>	<b><u>4795</u></b>	<b><u>1380</u></b>	<b><u>385</u></b>	

**Table 5** 19 hyper-systems generated within the quarter-tone model with the limited alphabet of intervals with “2”, “3”, “4”, “5”, and “6” quarter-tones. Columns to the right of the “Value” column express numbers of systems or sub-systems with or without conditions (fourth or fifth); rows with green background underline hyper-systems that generate most of the scales described in specialized literature, while a gray background stresses the existence of original *Ḥijāz* and *Ḥijāz-Kār* systems, today mostly considered as outdated variants by Arabian (but not Persian, for example) musicians and theoreticians (see [Beyhom, 2014]); H: Hyper-system (numbers in this column correspond to the rank of the hyper-system); NS: Number of Systems in current H; NSS: Number of Sub-Systems in current H; NSS4: NSS in just fourth from tonic; FF: NSS with a just Fourth in a just Fifth from tonic – all these are further explained in the text.

- Two relatively homogeneous hyper-systems, nos. 16 = 2334444 and 19 = 3333444, generate scales which are mostly used in Arabian music. Hyper-system no. 17, although very homogeneous, 3333336, is not in use (notably) because its intervals can add up neither to a just fourth (sum = 10) nor to a just fifth (sum = 14).
- Hyper-systems nos. 1, 6 and 12, share with hyper-system no. 19 an important feature: more than half of their sub-systems have a fourth or a fifth beginning with the first interval.
- System 2 4 4 2 4 4 4 in hyper-system no. 12 (this is the ditonic system that we have noted before) maximizes the number of fourths or fifths since six out of seven of its sub-systems contain a direct fourth and a direct fifth in relation to the tonic. Seven out of seven have either of them. This is the only system, among those generated with this model, with such qualities.
- Hyper-systems which have the augmented seconds of Western music in a *hijāz* tetrachordal combination (*i.e.*, containing at least one interval of one-and-a-half-tones – or 6 – and two intervals of one-semi-tone – or 2 – in the form 2 6 2) generate large numbers of systems and sub-systems; these are hyper-systems nos. 1, 6 and 9. This is an indication that these scales are a reservoir for modulation from and to ditonic scales. Along with hyper-systems nos. 12, 16 and 19, these generate about one hundred sub-systems that are the most frequently used, or mentioned in specialized literature.

As shown in Table 5, Hyper-systems 12 and 19 are main containers, respectively, for the Western and Arabian scales; Fig. 16 shows the de-ranking process for the scale of *maqām Rāst* and the resulting scales in suites of quarter-tones. The rank of (the scale of) *maqām Rāst* in the quarter-tone database is, however, “3” as the scale of *maqām ‘Ushayrān* (3344334) is the scale that minimizes the integer value of the system (Fig. 17).

Reintegrating these scales in the general database of the quarter-tone model and arranging them in

ascending order we get the scales issued from the de-ranking process on Fig. 18. This allows for a permanent and unambiguous identification of the 4795 scales of the Octavial database.

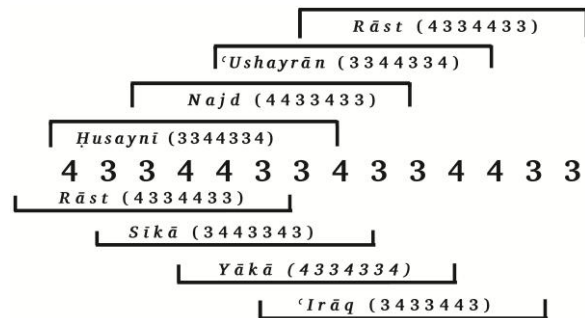

Fig. 16 De-ranking the scale of Arabian *maqām Rāst*.

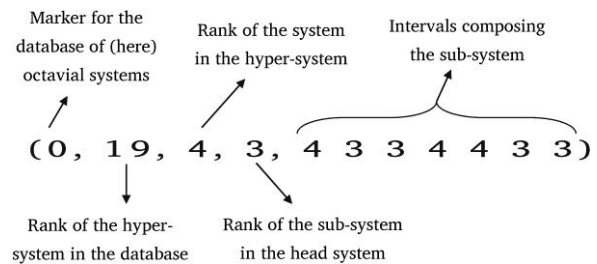

Fig. 17 Classifying the scale of *maqām Rāst* within the octavial<sup>104</sup> database in the quarter-tone model (reduced alphabet with ‘2, 3, 4, 5, 6’ quarter-tones).

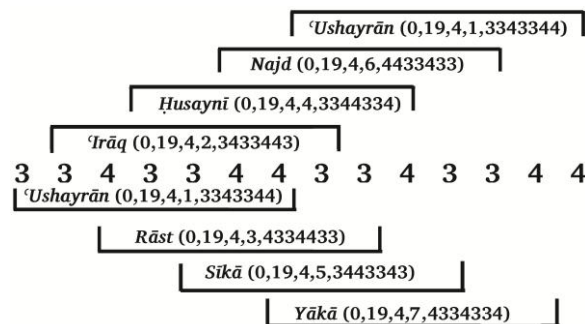

Fig. 18 De-ranking the scale of *maqām ‘Ushayrān* within the general database of the quarter-tone model (with reduced alphabet ‘2, 3, 4, 5, 6’ with quarter-tones) and corresponding classification of the resulting scales.

Useful to know, the scales of hyper-systems nos. 12, 16 and 19, although stemming from hyper-systems with a reduced generative capacity, with about 22% of the total of sub-systems, form from two thirds to three

<sup>104</sup> As explained further in the text, Modal systematics also applies for non-octavial scales, a subject explored in [Beyhom, 2003c] but too voluminous to be explained here.

quarters of the reservoir of scales used, or attested in Arabian music.<sup>105</sup>

Their ratio of sub-systems with a double fourth and fifth from the tonic is close to 39% with most of the other sub-systems in usage (see rows with variants or “close to” in the column of remarks of Table 5, *i.e.*, hyper-systems nos. 4, 10, 11 and 15 – the number of sub-systems marked FF for these represents a ratio of more than 46% of the total) contained in hyper-systems related to them.

- In the “Remarks” column with Table 5, variants are mainly scales containing an alternative *hijāz (-kār)* tetrachord made up of intervals of 2, 3 and 5 quarter-tones. This is a possible indication that this tetrachord evolved from earlier forms such as 2 5 3 or 3 5 2, to our standardized form of 2 6 2, because of the pressure induced by the existence of the semi-tone equal temperament.<sup>106</sup>

These remarks, made on the basis of the quarter-tone generative model of modal systematics, suggest already some criteria which may be applied in statistical studies of systems and sub-systems as we shall apply in Part II of the present article. These criteria will help answer the question why out of 12 possible intervals in a semi-tone distribution, or out of almost 24 intervals in a quarter-tone distribution, only seven are combined, in most music, to form an octave? And why are there three intervals in a fourth and four in a fifth, generally.

Before answering these questions, we must return to Urmawī’s tetrachords, in order to have a better understanding of how, by applying the qualitative interval differentiation concept, uneven divisions of the octave can amount to even ones.

### *Applying modal systematics to Urmawī’s tetrachords*

In Urmawī’s model, we have distinguished intervals of the second by means of the capacity of integers, from 1 to 5 (Fig. 6: 16). If we combine these intervals in the frame of a fourth, the sum of which must be

<sup>105</sup> Some of the scales found in the literature are questionable: a review of Arabian scales is given in [Beyhom, 2003b] (for example p. 15-50).

<sup>106</sup> This is discussed in [Beyhom, 2007b], and further in the dossier [Beyhom, 2014].

equal to seven elementary intervals, we obtain the following hyper-systems:

• 1 1 5	• 1 3 3
• 1 2 4	• 2 2 3 <sup>107</sup>

Hyper-systems within the fourth as a containing interval, with two identical intervals generate one single system equivalent to the generative hyper-system. They amount to three: 1 1 5, 1 3 3 and 2 2 3. Among them, the last two agree with Urmawī in the *Book of cycles*, with intervals not greater than the tone. By de-ranking, possible combinations of the intervals contained in the three aforementioned hyper-systems are, for the first, combinations 1 1 5, 1 5 1 and 5 1 1. For the second, combinations 1 3 3, 3 3 1 and 3 1 3. For the third, combinations 2 2 3, 2 3 2 and 3 2 2. The remaining hyper-system, 1 2 4, generates two systems resulting in six distinct combinations which stem from 1 2 4: 1 2 4, 2 4 1 and 4 1 2, and stemming from system 1 4 2: 1 4 2, 4 2 1 and 2 1 4 (Fig. 19, left).

All tetrachords in hyper-systems 2 2 3 and 1 3 3 are known both to Urmawī’s *Book of cycles* and to modern *maqām* theory of the quarter-tone division of the octave (Fig. 19, right).

The possible but missing tetrachords in the treatises have in common peculiar features: each of them contains two small intervals in a row, either two consecutive conceptual semi-tones or *leimmata*, or a *leimma* and a *mujannab* in a row, similar to the 1 and 2 intervals in Urmawī’s qualitative model (Fig. 19, left), and the 2 and 3 quarter-tones intervals in the quarter-tone model (Fig. 19, right). This is another criterion which will be applied in the statistical study which follows.

At this point, we may also note that the connection between the quarter-tone model and the model in Urmawī’s qualitative interval equivalents is straight forward: in order to shift from Urmawī’s model to the quarter-tone model, add one unit to each interval in the first (Table 6).

<sup>107</sup> These intervals can be considered, for the sake of simplification, as multiples of the 17<sup>th</sup> of an octave. The 17-ET model is a simplification of the 17 unequal intervals scheme(s) and is conceptually equivalent to the latter. This applies equally to the 24-ET model used in the statistical study in Part II of this article with a limitation of the smallest conceptual interval to the semi-tone.

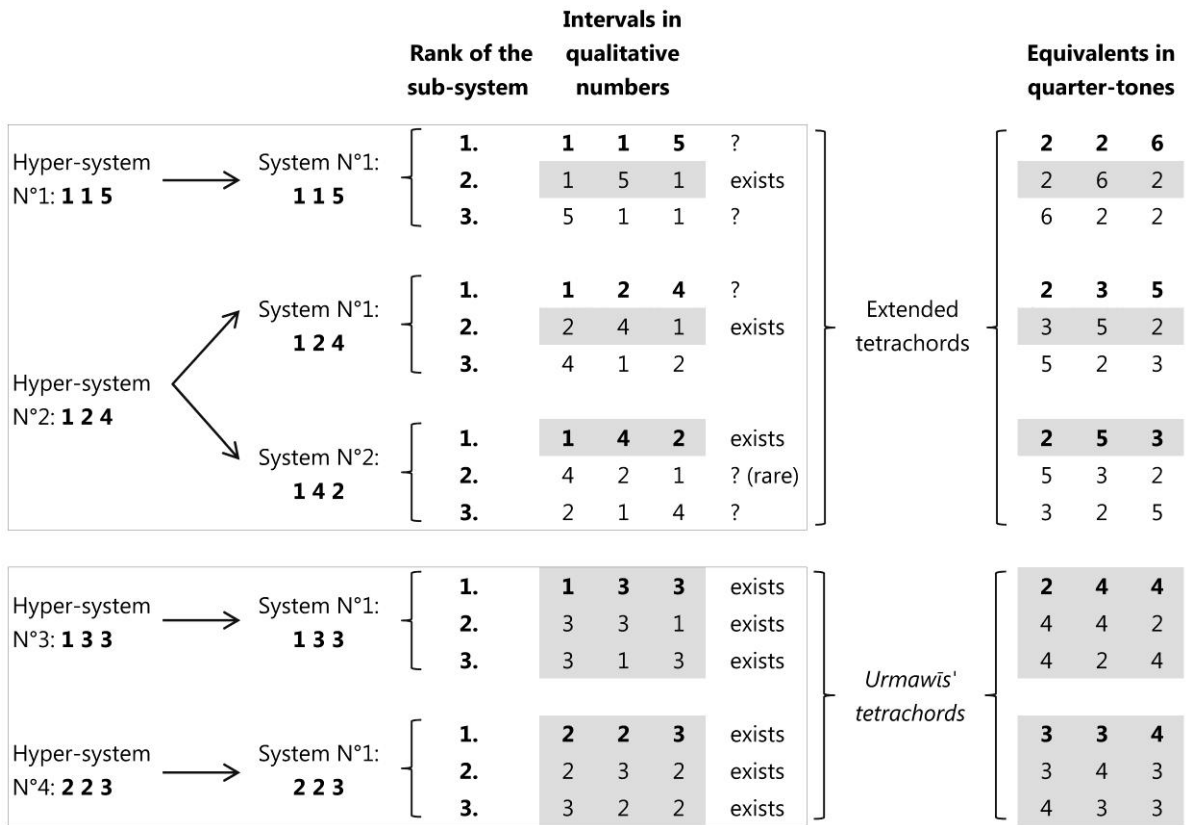

Fig. 19 Urmawī's tetrachords (the two hyper-systems below) and additional potential tetrachords, in both conceptual (qualitative) interval modeling (left) and quarter-tone approximation model (right). The tetrachords of Urmawī represent the full potential of the related hyper-systems; additional tetrachords (and hyper-systems) exist only partly in literature (and practice) of traditional Arabian music.

All the scales of the quarter-tone model connect directly with Urmawī's qualitative representation, through a unitary vector subtracted from the interval values in the former. For example, the *maqām Hījāz* scale, 2 6 2 [4] 2 4 4 (sum=24) in modern *maqām* theory (the square brackets identify the disjunctive tone between two tetrachords), becomes 1 5 1 [3] 1 3 3 (sum=17) in Urmawī's model, and the *maqām Rāst* 4 3 3 [4] 4 3 3, in quarter-tones becomes 3 2 2 [3] 3 2 2, or two similar tetrachords composed of, successively, one 'one-tone' and two *mujannab* intervals, with a disjunctive one-tone [3] interval.

Urmawī	Transition	Quartertones	Transition	Urmawī
1	+ 1	2	-1	1
2	+ 1	3	-1	2
3	+ 1	4	-1	3
4	+ 1	5	-1	4
5	+ 1	6	-1	5

Table 6 Transition from Urmawī's conceptual intervallic representation to the quarter-tone model, and reciprocally.

In the model applied to Urmawī's intervals which consist in a division of the octave in 17 equal parts, the total sum of the intervals must amount to 17 elementary intervals in one octave.

The transition to the quarter-tone interval is straightforward, as by subtracting one unit in each conceptual interval of a heptatonic scale in the quarter-tone model, we end up subtracting seven units from the total of 24 quarter-tones, which gives the sum of 17.

All the scales of the quarter-tone model, arising from the hyper-systems in Table 5: 24 have equivalent counterparts in Urmawī's model.<sup>108</sup> This proves that the two models are, in essence, conceptually equivalent.<sup>109</sup>

<sup>108</sup> And reciprocally – see Appendix J for systems in Urmawī's model.

<sup>109</sup> Complementary research (see [Beyhom, 2007c] and [Beyhom, 2010b]) showed a continuity of the 17 unequal intervals per octave model (or seven elementary intervals in a just fourth and

As a further consequence, all the results from the statistical analysis, resulting from generations with the limited alphabet, from 2 to 6 quarter-tones, may be applied to Pythagorean equivalents in Urmawī's model.<sup>110</sup>

Another conclusion may be drawn at this stage. Urmawī's concept of the scale, regardless of Pythagorean procedures used to explain, or legitimize his ideas about music, is profoundly Aristoxenian and based on a combination model. Moreover, Urmawī's concept is, as with Modern Arabian theories of the scale, additive (see Fig. 21), and not divisive (*i.e.* Pythagorean-based – see Fig. 20).

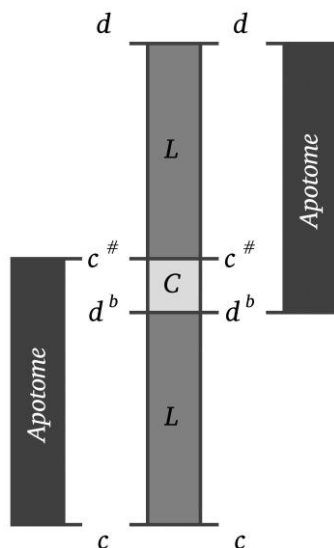

Fig. 20 Alterations in Pythagorean theories adapted to the Common practice scale of western music are divisive: intervals  $c_c\#$  and  $d_d^b$  intersect.<sup>111</sup>

In modern terms, altering an interval<sup>112</sup> is different from altering a note of the scale. Whenever altering an

→ three in a one-tone interval), throughout the history of Arabian theory, beginning with Kindī (9<sup>th</sup> century).

<sup>110</sup> The internal structure of the fourth or of the fifth may differ within the 17 intervals to an octave model and the quarter-tone model, when considering possibilities other than the three intervals to the fourth and four intervals to the fifth. Furthermore the 17<sup>th</sup> of octave model allows a differentiation between the chromatic tetrachords, based on hyper-system 1 2 4 in the 17<sup>th</sup> of octave model, and the enharmonic tetrachord which may be represented by system 1 1 5.

<sup>111</sup> Adapted and translated from Fig. 16, p. 115 in [Beyhom, 2014]; L stands for *leimma*, C for *comma*, both Pythagorean.

<sup>112</sup> A common characteristic in “Oriental” theories of the scale, including Byzantine chant – see [Azar Beyhom, 2012] for the explanations of Mikhā'il Mashāqa (who compares the “Arabian

interval means adding or removing a measuring (or small conceptual) interval from it, altering a note in western (Pythagorean based – Fig. 20) theories is a divisive concept,<sup>113</sup> from which we deduce that  $d_d^{flat}$  is one comma lower than  $c_c^\#$ , whenever an “augmented”  $b_c$  interval (or its equivalent) with Urmawī will always be below the “diminished”  $c_c d$  interval.<sup>114</sup>

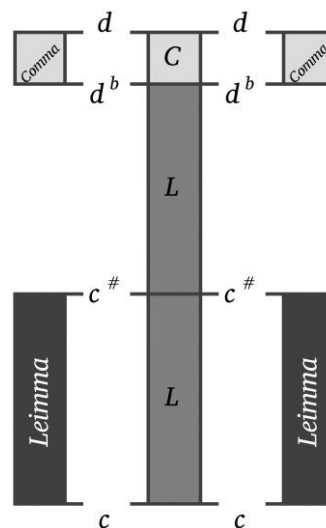

Fig. 21 Conjunct intervals and consecutive action of the alterations with Urmawī: intervals  $c_c\#$  and  $d_d^b$  are independent from one another, and separated by  $c_c^\#_d^b$  which is one *leimma* – adapted from Fig. 17, p. 115 in [Beyhom, 2014].

This applies as a rule to the composition of conceptual intervals using elementary intervals. The intervals within a fourth are derived from a combinatory process where the fourth and the fifth add up to an octave, a concept we can find throughout by Urmawī, with similar additive constructions of the tone, the fourth and the octave (Fig. 22).<sup>115</sup>

→ scale”, according to him, with Chrysanthos Madytos’ scale) about Arabian modes in the first half of the 19<sup>th</sup> century, and [Beyhom, 2015a] for more explanations on the alterations in Byzantine theories of the scale (19<sup>th</sup> to 21<sup>st</sup> centuries).

<sup>113</sup> Intervals  $c_c\#$  and  $d_d^b$  intersect – see Fig. 20.

<sup>114</sup> Consecutive action of the alterations: intervals  $c_c\#$  and  $d_d^b$  are independent from one another, and separated by  $c_c^\#_d^b$  which is one *leimma* – see Fig. 21.

<sup>115</sup> In his *Book of cycles*, Urmawī takes the fifth (as was the case in Ancient Greek theory which inspired him) as a fourth to which a one-tone interval is added. With this concept of the scale, a fourth plus a fifth amounts to the same as combining two tetrachords (in fourth) and a one-tone interval in the frame of one octave, which, in Modal systematics, is equivalent to the combination of three intervals (among which two are equal) with a fixed sum.

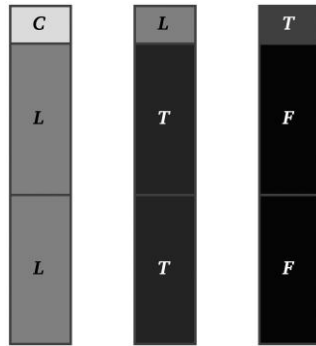

Fig. 22 Similar concepts by Urmawī for the construction of the tone (left), the fourth (center) and the octave (right).<sup>116</sup>

### Conclusion for part I

A quantitative model based on the equal division of the octave can be a qualitative model, taking in account the size of the intervals of which the scale is composed. They express the number of elementary intervals which build up each of the conceptual intervals.

In the case of the quarter-tone model, the smallest elementary interval is the approximate quarter-tone (the measuring interval), the smallest conceptual interval is composed of two elementary intervals, or two approximate quarter-tones, etc. Combining the resulting conceptual intervals, we combine qualities of intervals that are differentiated by their capacity to contain elementary small intervals (Fig. 23).

Urmawī’s concept is that there are two elementary intervals: the *comma* and the *leimma*. In modern Arabian quarter-tone theory, these would be the quarter-tone and the semi-tone, respectively.

This means that the scales which result from that type of generative model have intervals of seconds which, if measured exactly, would differ from one another even when having the same interval capacity; for example, a one-tone interval in one scale may be slightly different from a one-tone interval in another scale, as differences of intonation may occur – but the interval remains conceptually the same.

However, these intervals, when taken in relation to other intervals in the scale carry a unique quality

<sup>116</sup> *L* stands for *leimma*, *C* for *comma*, *T* for one-tone interval, *F* for (Just) fourth – see also FHT 28, p. 141 in [Beyhom, 2014] which shows the three levels of structuring of the intervals in Urmawī’s general scale.

which differentiates them from the latter, which is typical of modal systematics.

## PART II. COMBINING INTERVALS IN A SYSTEM: STATISTICAL ANALYSIS

### IMPROMPTU ON MODAL SYSTEMATICS, OR “WHY SO MUCH COMPUTING?”

One frequent remark about Modal systematics is that its systematical generation of scale elements is huge<sup>117</sup>, and partly “useless”; objections that came from renowned mathematical-musicologists<sup>118</sup> were mainly that there existed other, more economical ways of generating scales with the criteria defined in the original 2003 thesis and which were partly explained in Part I of this article.

Whenever this remark is true, these mathematicians forget two important facts: 1) a theory of traditional music<sup>119</sup> should never prescribe it, but only describe it; 2) the original idea of Modal systematics was not the elaboration of a “new” theory of the scale, which would prescribe, or even describe it; it was to found a series of tools based on intervallic description in order to, firstly, generate all the possible scalar elements within a particular model, then (secondly) apply supplementary tools to try to understand the mechanisms of the elaboration of the scale, through the thorough examination and comparison of the existing reservoir of polychords and scales of the so-called “Oriental” musics with the unconstrained possibilities of scalar elements generation.<sup>120</sup>

<sup>117</sup> See examples in appendices I, J and K.

<sup>118</sup> Mostly in France, from IRCAM (Institut de Recherche et Coordination Acoustique/Musique).

<sup>119</sup> That every theory of the elaboration of the scale should be.

<sup>120</sup> The main difference between generative theories and adaptive theories such as Modal systematics is that, although Modal systematics uses arithmetic and mathematics to model scale structures, its final goal is to adapt its axioms, and to sort the results in function of criteria stemming from existing musics in order to better understand and explain them. Other generative theories generally work independently from the existing structure of musics, and base themselves on axioms which are frequently biased or ill-adapted such as, for example, using successive thirds or fifths (either Pythagorean or in equal-temperament) as a paradigm for the formation of traditional scales (see for instance [Beyhom, 2016], Chapter III: “The cycle of fifths”).



## REMINDER ABOUT THE BASICS OF MODAL SYSTEMATICS

With modal systematics the basic process consists in combining intervals expressed as integers and then analyzing the results in relation to both music practice and theory. The elements of the scale consist in a sequence of consecutive conceptual intervals.

Conceptual intervals are stand-alone units in the scale. They are distinct in theory and in practice. They are placed between the notes of the scale. Their function is qualitative.<sup>130</sup> For an immediate identification of any interval in a scale series, Modal systematics determines the optimal (or the smallest, with the largest elementary interval) division of the scale, in such a way that the quantifying interval is the smallest conceptual interval and the elementary interval. In the semi-tone scale, the semi-tone is such that it fulfills the functions of quantifying, elementary and conceptual intervals.

With Arabian music,<sup>131</sup> the semi-tone model is ineffective because conceptual intervals, such as the zalzalian tone or zalzalian augmented second – the *mujannab* and the greater tone in Urmawī’s model in Fig. 6: 16, or the three-quarter-tones and the five-quarter-tones intervals in the quarter-tone model (Fig. 23: 30), cannot be distinguished and identified as conceptual intervals. Therefore, another division of the

octave is necessary to provide qualification for all types of intervals.

In this case it is the 17-ET, or the division of the octave in 17 equal intervals<sup>132</sup> which is needed, since this division allows for the distinction of all conceptual intervals. These small intervals have values (Fig. 6: 16) of 1 to 5.

Integers segregate the semi-tone 1, the *mujannab* or zalzalian second 2, the tone 3, the zalzalian augmented tone, or greater tone above 4 and the fully augmented tone, greatest tone above 5.<sup>133</sup> However, the 17-ET

<sup>132</sup> Which may be combined in order to compose conceptual intervals.

<sup>133</sup> The sizes of the greater and greatest tones in the 17-ET model suggest that the augmented second could be less, or greater than, the equal-temperament one-tone-and-a-half. The *hijāz* tetrachord (which today is usually made up of, in this order: one-semi-tone, one-tone-and-a-half, and one-semi-tone) is not mentioned in Urmawī’s list of tetrachords. This is very strange since this tetrachord is a combinatory variant of the old tonic chromatic Greek *genus* and commonly used in contemporary traditional music. Comparing sizes of the greater and greatest tones in the extended model, the difference between them would be one *comma*, which is the same difference existing between the *leimma* and the smaller *mujannab* (or the equivalent of an *apotome*). However, the relative size of one *comma*, compared to one *leimma* or one *apotome*, is very different from its relative size when compared to the greater and greatest tones. The difference, which is (for untrained ears) already difficult to hear between, for example, a double-*leimma* and a Pythagorean tone (add one *comma* to the former to obtain the latter), would be even less distinguishable between the two larger intervals. On the other hand, Urmawī could not have used the *leimma* between the greater and the greatest tones in order to differentiate them, as this would not have allowed for space, in the frame of a fourth, for two additional semi-tones (or *leimmata*) in a tri-intervallic configuration (Fig. 6, p. 16 – if we add one *leimma* to the greater tone, the capacity of the greatest tone would have to be one *comma* plus four *leimmata*. The capacity of the fourth in a Pythagorean 17 intervals model, is two *commata* plus five *leimmata* – i.e., a difference of one *comma* plus one *leimma*. This leaves no space for the two additional *leimmata*). This is possibly the reason why Urmawī gave up the *hijāz* tetrachord in its two (three) potential Pythagorean expressions, which would have been (a)  $M_1 + Ts + S$  or a succession of one small *mujannab* (*leimma* + *comma*, or *apotome*) plus one greater tone (tone + *leimma*) plus one semi-tone (*leimma*), (a’)  $S + Ts + M_1$ , or a succession of one semi-tone plus one “greater tone” plus one *mujannab*, and (b) the regular succession of one-semitone (*leimma*), greatest tone (tone + small *mujannab* – or *apotome*) and one-semi-tone (*leimma*) intervals (or  $L + \text{greatest tone} + L$ ) – see also the documented article [Schulter, 2013] on *buzurg*- (and *hijāz*-) like tetrachords (including in the Systematist era), and [Beyhom, 2014] on the modern *hijāz* tetrachord (in French).

p. 287–341]), is that determining the characteristics of traditional *maqām* music can help explore alternative scales within the frame of tradition: examples of such scales are proposed in the aforementioned thesis {see [Beyhom, 2003a, p. 333–335], with a few recorded – for three of them non-traditional – examples, namely Tracks 13 and 15-18 on the accompanying audio CD, entitled “13 - Beyhom - *Sikā-Hijāz*”, “15 - Saab 19, 5, 2, 3434343 sur  $la^{ab}$ ”, “16 - Saab 19, 5, 2, 3434343 sur  $si^{ab}$ ”, “17 - Multaka, AbuSamra 16, 13, 3, 4433424” and “18 - Multaka syst. modal 16, 7, 2433534 sur  $re^{ad} - mi^{ab}, si^b, la^{ab}, do^{ad}, fa^{ad}, (soD)$ ”}.

<sup>130</sup> Although some theoreticians may consider them as an exact expression of the size of the intervals, which would be the wrong conclusion to make: recent research on the scales of *maqām* music (see [Beyhom, 2010b; 2012; 2015a]) suggest that equal-divisions (with unequal interval sizes) of the string on lute-type instruments is probably the first theorizing tool used by musicians. The numbers of divisions used vary from one culture to another, one lute-type (or tuning) to another, but these still show a research of an optimum between complexity and expressivity (a concept explained further in this article) and confirm the general process explored in this article.

<sup>131</sup> As well as for an imposing other types of music.

model has a flaw which makes it difficult to see it as a representative division of the octave (Fig. 24).

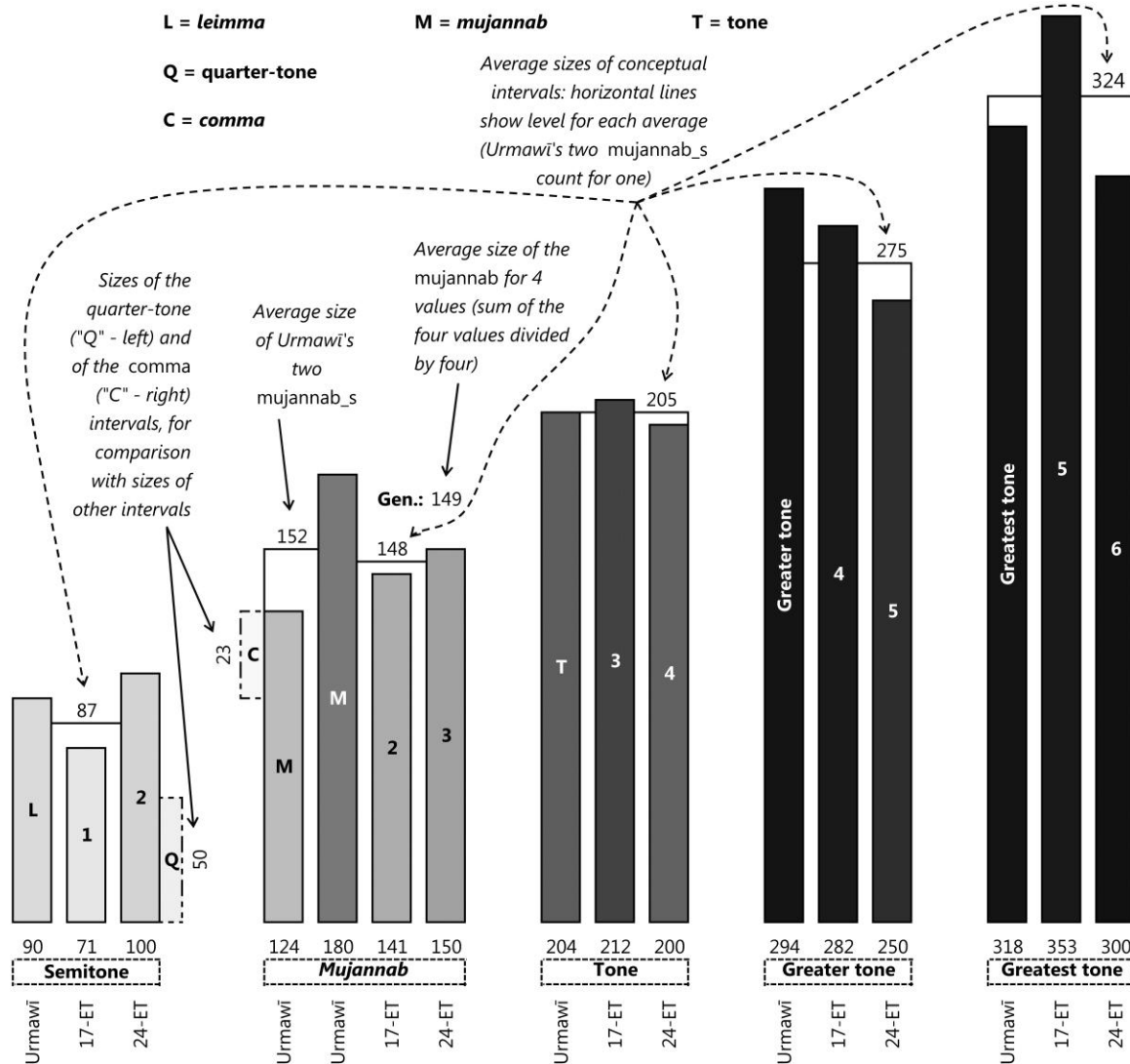

Fig. 24 Conceptual intervals from Pythagoras and Urmawi's, 17-ET and 24-ET models. Averages show that the transition from one conceptual interval to another, respectively 61, 57, 70, 49, with the average value of 59, can be modeled by either the one-seventeenth of an octave, 71 cents, or the quarter-tone interval of 50 cents. The usage of *commata* and *leimmata* in Urmawi's model accentuates the unevenness with *zalzalian* intervals, the *mujannab* and the greater tone – the “zalzalian augmented” second.

If taken strictly as a measuring interval, the 17<sup>th</sup> of an octave is 71 cents. Adding these intervals, we have 494 cents for a fourth and 706 cents for a fifth. These figures are close enough to the corrected values of the fourth and the fifth in the Pythagorean system, i.e., 498 cents and 702 cents.

The problem lies with the representation of the semi-tone. If the 17<sup>th</sup> of an octave is conceptualized as a semi-tone interval, the discrepancy with an equal temperament semi-tone, in approximation is 29 cents,

or  $100-71=29$ , which is unacceptable to most musicologists.

As a result, and although the measuring 17<sup>th</sup> of an octave interval which divides the octave in 17 equal parts is also an elementary<sup>134</sup> and a conceptual interval,<sup>135</sup> we shall take the quarter-tone model for

<sup>134</sup> Used in the composition of other intervals.

<sup>135</sup> Furthermore, that the numbers in the scale series express, before all, the quality of the intervals.

Arabian-Persian-Turkish music bearing in mind the equivalence between the two models.<sup>136</sup>

### *The principle of economy: optimal balance between method and expression*

In his first paragraph of his *Tonality of homophonic music*, Helmholtz said of the musician's liberty:

"Music was forced first to select artistically, and then to shape for itself, the material on which it works. [...] Music alone finds an infinitely rich but totally shapeless plastic material in the tones of the human voice and artificial musical instruments, which must be shaped on purely artistic principles, unfettered by any reference to utility, as in architecture, or to the imitation of nature as in the fine arts, or to the existing symbolical meaning of sounds as in poetry. There is a greater and more absolute freedom in the use of the material for music than for any other of the arts. But certainly it is more difficult to make a proper use of absolute freedom, than to advance where external irremovable landmarks limit the width of the path which the artist has to traverse. Hence also the cultivation of the tonal material of music has [...] proceeded much more slowly than the development of the other arts. It is now our business to investigate this cultivation".<sup>137</sup>

For thousands of years, freedom in music has been restricted by the necessity to produce recognizable pitch patterns making up melodies.<sup>138</sup> To this end, most cultures use heptatonic scales. They are a paradigm for

<sup>136</sup> As a general remark on Urmawī's Pythagorean model, the sizes of zalzalian intervals, particularly in the *Book of cycles*, seem a bit far from their counterparts in music practice (and in Fārābī and Sīnā's theories). Owen Wright has explored this at length in his aforementioned *The Modal system...* I have shown, however, that Urmawī's concept of the scale is not tonometric. It is qualitative (and conceptually additive). This is why the quantitative values of the intervals should not be taken into consideration for practice. Only their qualitative values should, of which the most important being the *mujannab* which lies somewhere (in size) in-between the one-*leïmma* and the one-tone intervals. Appendix K (download from <http://nemo-online.org/articles>) is provided for comparisons between the quarter-tone generations and the 17<sup>th</sup> of the octave generations – as explained above, it suffices to add 1 to each interval in Urmawī's scales to obtain the quarter-tone equivalents.

<sup>137</sup> [Helmholtz, 1895, p. 250].

<sup>138</sup> Free Jazz or contemporary Western music break away from this principle and try to explore all the possibilities of sound. These attempts, although sometimes memorable, were never popular. It could be that music has an emotional power which may not exist with other forms of art, and that this emotion is induced by a process of reminiscence, the more predominant in music because of 1) its transience and 2) due to the long-term impossibility of recording it.

composition. In order that a melody can be recognized, the degrees of the scale must be identifiable by pitches in relation to the other degrees of the scale.

When these are expressed as intervals, they become conceptual intervals where each has its own quality so that they can be identified. Conceptual intervals must neither be too small as they would be too difficult to perceive, nor too big, as in both cases melodies may not be easily perceived.

Variations of intonation or subtle differences of intervals, especially with music which does not answer to any known temperament, are the consequence of impromptu performance, great mastery, regional variations, organology, particular tuning and so forth, all combined with the ability of the performer.<sup>139</sup> In a traditional process of knowledge transmission, however, these subtle variations, particularly in the domain of performance mastery and instant creativity, take place at a later stage of music understanding and perception.<sup>140</sup>

In order to transmit and receive,<sup>141</sup> a basis must be found allowing for a firm structure of the musical discourse, whilst allowing the performer the possibility to further develop his freedom of interpretation. This basis, which is the essence of the melodic repertoire, is commonly named the scale.

When confronted with an audience, a traditional musician of average talent would try to perform with utmost expression and invention, keeping in mind the need for a melodic pattern that his listeners will recognize.

This process should request the least possible energy whilst taking the least possible steps within the continuum of pitch, in the search for balance between technique (or complexity of the means used) and

<sup>139</sup> See [Beyhom, 2006; 2007a; 2007b; 2014; 2015a; 2016], notably in connection with modal heterophony.

<sup>140</sup> Whilst most of the characteristics described in this section correspond to melodic and *maqām* music, it would have been an aberration to include in these the characteristics of the semi-tonal harmonic language, as these are historically a later exception in music worldwide. Too many Western theoreticians and "musicologists" from the 18<sup>th</sup>-21<sup>st</sup> centuries have forgotten this simple fact in their eagerness to promote the ditonic scale as the perfect paradigm for music – see [Beyhom, 2016].

<sup>141</sup> This is the basis of tradition, and traditional music worldwide.

expression (or the effect of the musical discourse on the audience).

In order to achieve this goal, this musician would ideally need to have previously tested all possibilities, within an octave or other important containing intervals, and determine which would result in the maximum number of expressive possibilities.<sup>142</sup> The process for interval combination and the search for the optimal number of intervals within a “fourth”, a “fifth” or an “octave”<sup>143</sup>, will be defined as stemming from the *principle of economy*.

### *A semi-tone and quarter-tone model for polychords and scales*

The two models in this study are the (semi-tonal) Western and the (Modern, quarter-tonal) Arabian. Whilst Common-practice western music uses the semi-tone, the quarter-tone is the basis of conceptual divisions with the *maqām* where subtle refinements reveal modal complexity.<sup>144</sup> In both cases, the smallest conceptual interval is an approximate semi-tone.

<sup>142</sup> If intervals are too small or too large, there are no longer any scale, or any pattern for the melody.

<sup>143</sup> The terms fourth, fifth and octave are in double-quotes because, in the statistical study, all possible compositions of these containing intervals are considered, *i.e.*, with more than, or less than, three (or four, or seven) conceptual intervals to a just fourth (or to a just fifth, or to an octave).

<sup>144</sup> Turkish music and Byzantine chant follow roughly the same rules as Arabian music. They used the *maqām* as a *lingua franca*. The Turkish model is an extension of Urmawī’s scale which might be better adapted to transpositions for the long necked *tunbūr*, and in the Chrysanthos of Madytos’ version of 1818, Byzantine chant follows a 17-ET paradigm (extended to the 68<sup>th</sup> of an octave, by dividing the 17<sup>th</sup> of an octave in four parts, called *minutes* – although Chrysanthos’ scale, the same as with Urmawī, is not based on equal-divisions of the octave, the relationship between the two scales is direct; see [Beyhom, 2015a] and Chapter IV in [Beyhom, 2016]). The 1881 Byzantine version of the Music Committee of Constantinople, a 24-ET model, had each quarter-tone being further divided in three equal measuring intervals (or a semi-tone equal temperament, with each of the semi-tones divided in six equal minutes, resulting in a 72-ET model – in practice, however, the divisions of the scale correspond to even multiples of the *minutes*, *i.e.* sixths of the tone). In both types, conceptual intervals remain equivalent to those in Arabian music, with the greatest conjunct tone (in the chromatic tetrachord) of Byzantine chant being equivalent to the greatest tone in Urmawī’s model. On the other hand, Ancient Indian music follows the same concept of interval quality because with the principle of 22 unequal *śrutis* the conceptual intervals are the result of a theoretical concatenation of smaller intervals, which are themselves elementary and auxiliary

A recurrent objection to the use of the semi-tone interval as a smallest conceptual interval is that the Arabian quarter-tone is half its size. Some theoretical modern descriptions of *maqām Awj-Āra*, for example, show indeed one quarter-tone intervals in the scale.

This *maqām* is reminiscent of Turkish music as its scale is similar to the *maqām Ḥijāz-Kār*, but with *AWJ* (= *b*)<sup>145</sup> as its starting note. This causes some cultural and technical problems with the organology of the *ūd*, because of the usage of the theoretical equal-quarter-tone in the 1920s and 1930s.<sup>146</sup> These problems are easily resolved with the difference between conceptual and measuring intervals I have explained.<sup>147</sup>

Another objection to Arabian performance is mainly with *maqām Sīkā*. It begins, as its name suggests, with *SĪKĀ*, = *e*. In the quarter-tone model, this scale equates to 3 4 4 3 3 4 3, beginning with *e* and with a *b* between the conjunct two-three-quarter-tones intervals. In the common Arabian tuning of the *ūd*,<sup>148</sup> the open strings of lower pitch are often used as drones repeating the fundamental note of the

→

intervals (see also the second part of [Beyhom, 2012] – for an overview of the tonal systems of Indian music, see for example [Powers and Widdess, 2001], p. 170-178). Other subdivisions of the scale, for example those of Javanese and other musics, would be explored in detail in future publications.

<sup>145</sup> *Maqām Ḥijāz-Kār* traditional beginning (and reference) note is *RĀST*, commonly considered in Arabian music as equivalent to the Western note *c*.

<sup>146</sup> This was mainly spread through the collective *Recueil des Travaux du Congrès de Musique Arabe qui s’est tenu au Caire en 1932 (Hég.1350)*, [Collectif, 1934], and Erlanger’s fifth tome of *La musique arabe*, [Erlanger, 1949].

<sup>147</sup> For a detailed study of this problem, see [Beyhom, 2003a, p. 314–317] – in French. Furthermore, in a live performance, I have heard only once an Arabian version of *maqām Awj-Āra*. This was played by Moroccan lutenist Saïd Chraïbi, in 2005. In a private conversation, the musician explained that he used the scale of *Awj-Āra* as given in Erlanger because he could not get a hold on a recorded Arabian version of this *maqām*. Chraïbi had already made at least two recordings [Chraïbi, s.d. ; s.d.] including this *maqām*, with no references or commercial identification, which I later acquired under the titles *Souleimane* and *Taqassim Aoud*.

<sup>148</sup> This instrument is the main reference in both theory and practice for Arabian music and musicians. It is commonly tuned in ascending fourths with an additional (lowest) variably tuned string. This string is sometimes tuned to *e* whilst performing *maqām Sīkā* or other modes beginning on *e*.

→

*maqām*.<sup>149</sup> In order to reinforce the fundamental, some contemporary lutenists tune the lowest auxiliary string to *E*-. Many, however, prefer to keep the original tuning<sup>150</sup> and use a technique of fast alternation between *e*- and a note about a third of a tone lower,<sup>151</sup> and quickly coming back and insisting on *e*- so that the fundamental *e*- is reinforced. The small interval used between *e*- and the slightly lower pitch<sup>152</sup> is only a variation and is used intonationally. Its main function is to underline the importance of *e*-, the next, the lower degree in the scale being *d*, which is (approximately) three quarter-tones away from *e*-. This is why the performer must use a smaller interval of intonation leading to the fundamental.<sup>153</sup>

Now that these two main problems have been addressed and that the limitation of small intervals is taken in both models as equal to the conceptual semi-tone, two possibilities have been considered regarding the largest interval in the scale. It must be firstly limited only by the size of the octave, and by the minimum of two intervals amounting to a scale element, or secondly by the largest conceptual interval in both models, *i.e.*, the one-and-a-half-tones interval.<sup>154</sup> As a result, each generative process uses alternatively two alphabets. In the semi-tone generation, the first alphabet is without limitations except for the semi-tone division. The largest interval in the alphabet is the largest possible allowed in a particular generation. The second alphabet is reduced to the three conceptual intervals of one semi-tone 1, one tone 2, and one and a half-tones, 3, or augmented second.

<sup>149</sup> The drones are sometimes used to accentuate the role of a structural note of a particular scale.

<sup>150</sup> The tuning of the *ūd* is difficult and time consuming. One musician has confided to the author and other participants, during a workshop at Royaumont (France), and probably with some exaggeration, that he had probably spent half of his twenty years of professional career tuning the *ūd*. See [Beyhom, 2006].

<sup>151</sup> Mostly when coming back to the fundamental as a resting note.

<sup>152</sup> An approximate third of the tone (66 cents), which is very close to a 17<sup>th</sup> of an octave (71 cents).

<sup>153</sup> This whole discussion wouldn't need to take place, had the Arabs kept the 17 intervals paradigm of Urmawi: alas, Western theories of the scale have been very efficient at influencing Arabs and others, resulting in the quarter-tone notation.

<sup>154</sup> Bearing in mind that the size of this interval may be, in performance, greater or lesser than the exact one-and-a-half-tones.

This also applies to the generation process for the quarter-tone, except that in this case, the interval increments are quarter-tones, with a limited alphabet of 2, 3, 4, 5 and 6 of them (Fig. 23: 30).

The generative process is simple. A computer program detects all the combinations of a certain number of intervals given in an initial alphabet of conceptual intervals (with a fixed sum of elementary intervals), and arranges the results as hyper-systems, systems and sub-systems. This process starts with the minimum possible number of intervals in the scale elements<sup>155</sup> and ends with the maximum possible number of elements in the containing interval. The minimum number of intervals in combination is two, and the maximum depends on the containing capacity of the intervals in the model.

With both models this corresponds to the number of half-tones in a row which can be arranged in a containing interval, *i.e.*, five for a fourth, seven for a fifth and twelve for an octave.

#### PRELIMINARY DEFINITIONS AND REMARKS

Specialized terms for scale systems will be used throughout this study, their definition follows:

1. A scale system is a sequence of numbers for different classes of conjunct (conceptual) intervals within the frame of a containing element.<sup>156</sup> This is defined as an interval composed of conceptual intervals with the sum of the containing element equating to the number of elementary intervals building up to it set to a certain value. Containing intervals are equal to the fourth, with an ascending frequency ratio of 4/3, and the fifth, with a frequency ratio of 3/2, and the octave.
2. A hyper-system is a capacity indicator of conceptual intervals. It is a scale element in which these intervals and the numbers composing the sequence, are re-arranged to form

<sup>155</sup> A scale element, here, is equivalent to a succession of conjunct intervals forming a containing interval. The minimal possible succession is made up of two intervals. The statistical study of the octave containing element (*infra*) shows sometimes the results for one single interval (*NI* = 1), to show symmetry with (*NI* = 12).

<sup>156</sup> Note that arbitrary smaller scale elements can be used, such as the eighth or the twelfth of the tone (or even the quarter-tone), but these are not conceptual intervals and would be used only for the purpose of further study of combinations with smaller divisions of the tone (or of the octave).

the least integer when numbers are concatenated. Hyper-systems are arranged, in the frame of a generative process, from the smallest (when expressed in integer concatenated form) to the largest.

3. A system is a particular arrangement of intervals in a hyper-system. Systems are also scale elements. They are arranged from the lowest corresponding integer to the highest within the hyper-system. A hyper-system is identical to the first ranking system it generates.
4. A sub-system is a particular arrangement of intervals inside a scale element which corresponds to a de-ranked system. The original system is the first sub-system, and each de-ranking produces the next ranking sub-system. The number of conceptual intervals, NI, henceforth, limits the number of sub-systems in a system, as some of the combinations resulting from the de-ranking process may be identical and therefore redundant. The number of non-redundant sub-systems may therefore be lesser than the corresponding NI. The first ranking sub-system in a system is identical to the head system.
5. NI is the number of conceptual intervals of conjunct seconds which constitute a scale element. In the statistical study below, NI is variable and extends from two conceptual intervals in a scale element, to the maximum possible number of smallest conceptual intervals in a row within the containing interval. In both models, the maximum number of conceptual intervals in a scale element is equal to the number of conjunct semi-tones – the smallest conceptual interval – required to build it up. The maximum number of conceptual intervals in a containing interval (NI<sub>max</sub>) of a fourth is equal to the number of semi-tones needed, *i.e.*, five consecutive semi-tones (NI<sub>max</sub> = 5).

A typical example of the relationship between hyper-systems, systems and sub-systems is shown in Fig. 15: 22 and Table 5: 24 where the 19 hyper-systems of the quarter-tone model generation with the limited alphabet 2, 3, 4, 5, and 6, and with seven intervals (NI = 7) to the octave, are arranged in ascending integer values. A typical hyper-system

generates ditonic scales, *i.e.*, hyper-system no. 12 in the generation with the reduced alphabet (Table 5: 24). This hyper-system generates three systems (Fig. 15: 22) for the corresponding semi-tone model, when each in turn generates 7 distinct sub-systems by de-ranking intervals in each system.<sup>157</sup>

Table 5 is specific to the general combination process used in modal systematics. Since the containing interval is equivalent to the octave, the sum of the integers (in un-concatenated form) in each scale is 12 half-tones in the semi-tone, and 24 quarter-tones in the quarter-tone model.<sup>158</sup>

With the fourth, the respective sums in the two models are 5 semi-tones or 10 quarter-tones, and in a just fifth 7 and 14 respectively. The equality of the intervals of the semi-tone and the quarter-tone models is straightforward. For the transition from a semi-tone interval system to its equivalent in the quarter-tone model, simply multiply the intervals of the integers by two. To reverse the process, divide all the integers in the quarter-tone model by two. However, intervals represented by odd integers in the quarter-tone model have no equivalents in the semi-tone model. This is the reason why the ranks of the hyper-systems in the semi-tone model are corrected to their rank in the quarter-tone model, as explained in the next section.

The main question is why the generally assessed number of conceptual intervals in a modal scale is seven in an octave, or what is the optimal number of conceptual intervals in containing intervals with ratios 4/3, the fourth, 3/2, the fifth, and 2, the octave.

<sup>157</sup> Reminder: the full database of the hyper-systems, systems and sub-systems of the heptatonic scales in the quarter-tone model, with the limited alphabet of intervals, can be found in Appendix I (download from <http://nemo-online.org/articles>) and in [Beyhom, 2003b], p. 113 sq.

<sup>158</sup> Computations in Urmawi's model show that the results would be, however, similar to the results in the quarter-tone model, with mainly differences in the composition of the lesser containing intervals, *i.e.* the fourth and the fifth: these and other particularities of Urmawi's model will be explained in a further publication.

## COMBINING INTERVALS WITHIN A FOURTH: FILTERS AND CRITERIA

In a combination process of conceptual intervals using the semi-tone as the smallest conceptual interval, the sum of the containing interval of the fourth<sup>159</sup> must be 5 in the semi-tone, and 10 in the quarter-tone models. Our first goal is to find all combinations of intervals of the alphabet that sum up to these values.

In the semi-tone generation (Fig. 25, top), the alphabet is unlimited, except by the semi-tone structure of the intervals. The smallest interval is the semitone, and the largest, for NI=2 (two intervals in combination) can therefore only be a 4 semi-tones interval, 4 in the concatenated sequence of intervals, '[14]' in the first hyper-system of the semi-tone scale generation with NI=2.

The sum of the two intervals in the first hyper-system is equal to  $1 + 4 = 5$ . The other hyper-system for NI=2 is 23, with two intervals 2 and 3 (the semi-tone value is represented by the two digits).<sup>160</sup> The rank of the hyper-systems (first column to the left) is given both in the semi-tone (plain numbers) and the quarter-tone models (between brackets) if the two differ.

If the hyper-system does not exist in the semi-tone model, only the rank of the corresponding quarter-tone hyper-system is given (one number between brackets). For NI=2, the two hyper-systems 14 and 23 both generate one single system, with two sub-systems for each system. For NI=3, we still have two (but different) hyper-systems (or capacity indicators) which generate each one single system, but with three sub-systems each (due to the three conjunct intervals in the system).

This generation corresponds to the commonly accepted number of three intervals in a fourth, and contains the tetrachord equivalent of the tense diatonic *genus*, hyper-system 122, and of the tone, or tense chromatic: 113. For each of NI=4 and NI=5, we obtain one single hyper-system, with four sub-systems

for NI=4, and five identical, (with four which are redundant) sub-systems for NI=5.

The total numbers of hyper-systems, systems and sub-systems in each case figure in the row below the last sub-system.

A first, and evident remark can be made. A small number of intervals, NI, implies that larger intervals have more chances to find a place in the system, whenever a larger NI results in an increased use of smaller intervals, notably here the semi-tone. Additional rows below the grand total give the numbers of remaining sub-systems for each NI whenever some eliminating conditions are met (the number of excluded sub-systems is shown in brackets, with a minus sign):

1. The total number of non-redundant sub-systems is equal to the initial total number of sub-systems minus the number of redundant sub-systems in each case. Redundancy occurs once in the semi-tone model, for NI=5. Here the hyper-system, system and sub-system(s) are identical, as one single interval class, the semi-tone, is used in the scale element. These redundant sub-systems, generated through the de-ranking process, are struck out in Fig. 25 and must be excluded from the generative process.
2. The 'double semi-tone criterion' (an asterisk is added at the end of each sub-system which responds to this criterion) excludes (separately from other filters) sub-systems containing two semi-tones in a row (conjunct semitones).<sup>161</sup> This filter, which has been inspired from Arabian music, is most effective when applied to sub-systems with a large number of intervals of greater values. If two consecutive semi-tones are present in a heptatonic scale, they are commonly found at the sides of the junction between two tetrachords, or at the junction between a scale and its equivalent to the octave, lower or higher.<sup>162</sup>

<sup>159</sup> We shall use the terms fourth, fifth and octave henceforth, bearing in mind that the number of intervals in these containing intervals is variable, and represented by NI. The term "just" for each of these intervals is to be considered as an implicit quality.

<sup>160</sup> These two intervals are taken as a successive one-tone and a one-and-a-half-tones

<sup>161</sup> This filter is one of the aesthetic criteria deduced from contemporary Arabian music and from Urmawi's model (which forbids two consecutive conceptual semi-tones). However, they do not necessarily apply, in the case of the fourth, to all modal music.

<sup>162</sup> See next footnote.

Semi-tone model												
Rank of HS	NI = 2			NI = 3			NI = 4			NI = 5		
	HS	S	SS	HS	S	SS	HS	S	SS	HS	S	SS
1	14	14	14>, 41>	113	113	113*, 131, 311*	1112	1112	1112*, 1121*, 1211*, 2111*	11111	11111	11111*
(2)												11111*
2 (3)	23	23	23§, 32§									11111*
2 (4)				122	122	122, 221, 212						11111*
(5)												11111*
Total	2	2	4	2	2	6	1	1	4	1	1	5
Total non redundant (-)			(-0) 4			(-0) 6			(-0) 4			(-4) 1
Double semitone criterion (*)			(-0) 4			(-2) 4			(-4) 0			(-5) 0
Conjunct big intervals (§)			(-2) 2			(0) 6			(-0) 4			(-0) 5
Intersecting criteria 1 (OR)			(-2) 2			(-2) 4			(-4) 0			(-5) 0
Large intervals			(-2)			(-0)			(-0)			(-0)
Small conjunct different intervals			(-0)			(-0)			(-0)			(-0)
Intersecting criteria 2			(-4) 0			(-0) 4			(-4) 0			(-5) 0

Quarter-tone model												
Rank of HS	NI = 2			NI = 3			NI = 4			NI = 5		
	HS	S	SS	HS	S	SS	HS	S	SS	HS	S	SS
1	28	28	28>, 82>	226	226	226*, 262, 622*	2224	2224	2224*, 2242*, 2422*, 4222*	22222	22222	22222*
2	37	37	37>, 73>	235	235	235, 352, 523	2233	2233	2233*, 2332, 3322*, 3223*	22222	22222	22222*
(2) 3	46	46	46§, 64§		253	253, 532, 325		2323	2323, 3232, 2323, 3232			22222*
4	55	55	55§, 55§	244	244	244, 442, 424						22222*
(4) 5				334	334	334, 343, 433						22222*
Total	4	4	8	4	5	15	2	3	12	1	1	5
Total non redundant (-)			(-1) 7			(-0) 15			(-2) 10			(-4) 1
Double semitone criterion (*)			(-0) 8			(-2) 13			(-7) 5			(-5) 0
Conjunct big intervals (§)			(-4) 4			(0) 15			(-0) 12			(-0) 5
Intersecting criteria 1 (OR)			(-4) 4			(-2) 13			(-9) 3			(-5) 0
Large intervals			(-4)			(-0)			(-0)			(-0)
Small conjunct different intervals			(-0)			(-4)			(-8)			(-0)
Intersecting criteria 2			(-8) 0			(-6) 9			(-12) 0			(-5) 0

Fig. 25 Combinations and filters in the frame of a fourth containing interval: HS = Hyper-system, S= system(s), SS= sub-systems. Multiple criteria are applied, allowing for a better modeling of tetrachords existing in traditional music practice.

- For larger containing intervals such as the fifth and the octave, this criterion is applied for three conjunct semi-tones.<sup>163</sup>
3. The ‘conjunct large intervals’ filter (sub-systems marked with §) excludes scale elements containing at least two conjunct intervals larger than, or equal to, the one-tone interval, and among which one, at least, is larger than a tone. This is a general rule which is present in the heptatonic Arabian traditional scales. Examples of sub-systems with such characteristics are 46 and 55<sup>164</sup> for NI=2 in the quarter-tone model (Fig. 25, bottom). The criterion is most effective with smaller values of NI.<sup>165</sup>
  4. All these filters operate independently. If we combine them in one complex criterion, filtered subsystems will add up or merge (‘neither nor’, or a Boolean inversed ‘OR’ operator in the theory of ensembles) with a resulting number of filtered sub-systems in the row entitled ‘Intersecting criteria 1’.

<sup>163</sup> See [Powers et al., 2001], p. 775-860, sub Mode, §V, 3: Middle East and Asia: Rāga – (ii) Modal entities and the general scale, notably p. 838: “There are a few evident parallels between South Asian and West Asian orderings of modal complex and general scale. For instance, in both cases a given modal entity will use only some of whatever pitch positions an octave span of the general scale makes available – in principle seven – and normally no more than two intervals of the semi-tone class will occur in a succession in a single modal complex.” For the fourth, the 2 conjunct semi-tones filter is sufficient: note that there must be no exception for the tetrachord 622 Erlanger recognizes as *Sipahr* (see [Erlanger, 1949, v. 5, p.91] and the note to his first volume, p. 30). Erlanger says that he felt this (old tonic chromatic of Aristoxenos) tetrachord, should be included among other Arabian tetrachords. In [Fārābī (al-) et al., 1935, v. 2, p. 276], Erlanger (or Manoubi Snoussi, his secretary, see Poché’s introduction to the second edition [Fārābī (al-), 2001]) explains, nevertheless, that “In *genera* theory, the most sensitive matter is the order in which the intervals (de-)composing the fourth in melodic sounds are placed, in relation to one another. With Arabian music, or at least in its urban form, that may be called classical, there is no occurrence of two consecutive semi-tones in the same tetrachord”.

<sup>164</sup> In multiples of the quarter-tone. These are hyper-systems three and four (for NI=2) in Fig. 25, bottom.

<sup>165</sup> Sub-systems having intervals larger than the largest conceptual second (the greatest tone – in both models taken as equal to one tone and a half) are marked with a post positioned ‘§’ and kept ‘as is’, even when the conjunct large intervals filter is applied. However, their number is shown for each case (for each value of NI) in the Conjunct big intervals row.

The aim is to compare, excluding all filtered sub-systems, the results of the generative process for different values of NI and to determine the optimal number<sup>166</sup> of conceptual intervals in the containing interval. The results of the semi-tone generation, with or without filters applied to them, are shown in the two graphs of Fig. 26.

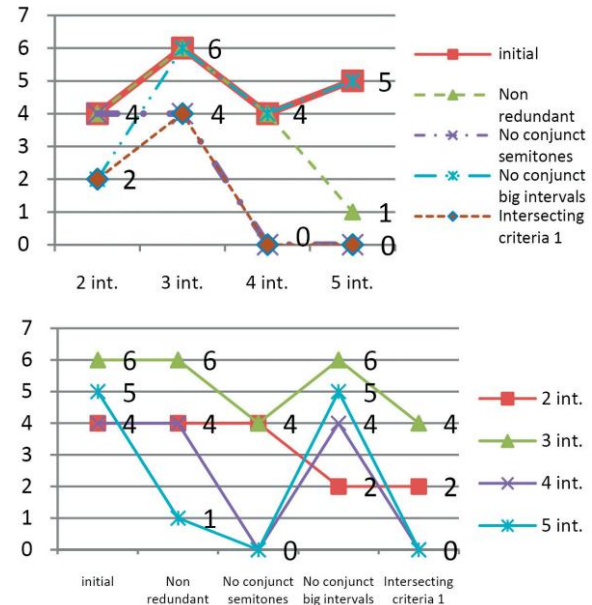

Fig. 26 Graphs of the distribution of sub-systems in a fourth, in relation with the number of intervals (conceptual conjunct intervals of second) in the scale element (above), and in relation with applied filters (below – cross-reference) for each case (NI = 2, 3, 4 and 5) – semi-tone model.<sup>167</sup>

The generation with NI=3 (or three conceptual intervals in a containing fourth interval) gives the largest number of independent, non-redundant, sub-systems, *i.e.*, 6. The filters or criteria, accentuate this optimal value.

If we exclude scale elements comprising large intervals (greater than the one-tone-and-a-half)<sup>168</sup> in addition to those excluded through the ‘intersecting criteria 1’ composed filter, the remaining two sub-systems in the case NI=2 would be equally eliminated,

<sup>166</sup> The smallest NI giving the largest number of sub-systems, after eliminating sub-systems that do not comply with the aesthetic criteria listed in Fig. 25.

<sup>167</sup> Results for filtered sub-systems should be compared to the values of the non-redundant line on the top-most graph, and to the corresponding values on the bottom one.

<sup>168</sup> This is equivalent to a generation with the limited alphabet of 1, 2, 3 in the semi-tone generation, and to 2, 3, 4, 5, 6 in the quarter-tone model.

leaving thus the case NI=3 as the unique possibility concerning the ability to generate a just fourth (see ‘intersecting criteria 2’, Fig. 25).<sup>169</sup>

The same applies to the quarter-tone distribution, (Fig. 27) with however some quantitative and qualitative differences in the contents of the two generations.

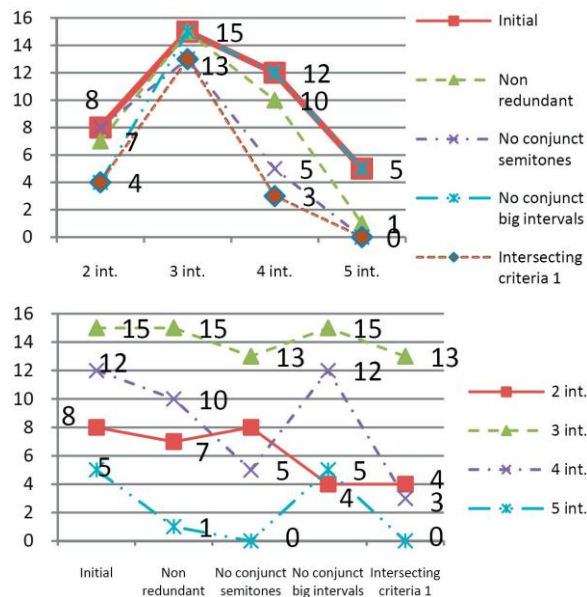

Fig. 27 Graphs of the distribution of sub-systems in a fourth, in relation with the number of conjunct conceptual intervals of second (NI) in the scale element (above), and (below) in relation with filters (cross-reference) applied in each case (NI=2, 3, 4 and 5) – quarter-tone model (compare with Fig. 26).

A first difference is that the quarter-tone model (Fig. 25: 38, lower half and Fig. 27) generates, as expected, intermediate and additional hyper-systems containing zalzalian interval equivalents (or odd multiples of the quarter-tone) which are for example hyper-systems nos. 2 and 4 in the case of NI=2.

Whenever the smallest and largest intervals are the same, in both semi-tone and quarter-tone generations, for the same NI (due to the limitation of the smallest conceptual interval to the semi-tone in both cases), then the intermediate hyper-systems generate additional sub-systems in the quarter-tone model. The optimal number of intervals (the most economic choice) is still three.

<sup>169</sup> The small conjunct different intervals criterion has no effect on the results of the semi-tonal generation.

All the filters accentuate the optimal value by giving the two neighboring sections of the line a smaller angle (in Fig. 27, top, ‘intersecting criteria 1’ give the most acute angle around value 13 for NI=3).

Fig. 25: 38 shows, however, that the new possibilities in the quarter-tone model are not fully integrated, for NI=3, in Arabian music, although this case comprises no redundant sub-systems.<sup>170</sup> The new sub-systems 235, 532, 523 and 325 are seldom or never used in this music, as the only configuration for hyper-system 235, with its two systems 235 and 253, seems to be the one which places the largest interval in the middle (i.e., sub-systems 253 and 352). If we were to add this criterion (i.e., if we dismiss sub-systems containing suites of very small intervals such as 23 or 32, in the quarter-tone model) to the filters already used for the semi-tone model of the fourth, we would end up having NI=3 as the unique possibility for this containing interval, because the remaining sub-systems for NI=4 are excluded by this criterion (see the row ‘intersecting criteria 2’ for the quarter-tone model in Fig. 25: 38).

THE REVERSE PYCNON RULE

All the filters and criteria used with the fourth correspond to common practice and theory and their application provides with complementary information on the aesthetics of modal music, especially with the *maqām* and modal diatonic<sup>171</sup> music. It would be interesting however to try to find one single criterion which would have the same effect as the four criteria explained above.<sup>172</sup>

Taking a closer look at the composition of the sub-systems commonly in use in the ditonic and Arabian

<sup>170</sup> This is because in order to generate redundant sub-systems, a system must contain a repetitive pattern, for example 112 (in the semi-tone multiples) in the 112112112 scale (an octave scale for which NI=9, and the sum of the conjunct intervals S=12) in the semi-tone model – other considerations allow for a better understanding of the redundancy phenomenon: see Appendix G which further explores this problematic (notably the final Addendum concerning generations in the fourth and the fifth Containing intervals), and the accompanying Power Point show with audio examples for redundant scales, in both semi-tonal and quarter-tonal models.

<sup>171</sup> Here in the general meaning of the word, i.e. not having a *pycnon* – see “The reverse *pycnon* rule” below).

<sup>172</sup> I do not count here the non-redundancy criterion, as this filter is self-evident.

music (Fig. 25: 38; quarter-tone model, in bold), and comparing the sums for any two conjunct intervals within them, we come up with a very interesting conclusion. All these sums are comprised between 6 and 8 quarter-tones.

Fig. 28 shows pairs of conjunct intervals in ascending values from the top and the left, beginning with a first interval of 2, and conjunct intervals (from top to bottom), beginning also with a 2, incremented until the maximum which is 8 quarter-tones, in order to complete the sum for the fourth.

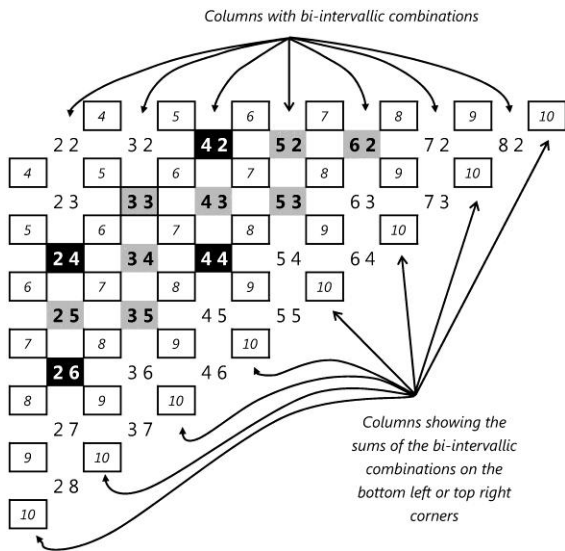

Fig. 28 Bi-interval elements of the generation for a containing interval of fourth in the quarter-tone model.<sup>173</sup>

The next column shows the same process, starting with interval 3 and a conjunct interval 2, with the conjunct interval incremented by one unit downwards. The largest interval for this column is 7, since the sum of the two intervals may not exceed 10, which is the value of the fourth in multiples of the quarter-tone.

The process continues for the other columns until all possibilities are given. Common bi-interval combinations are written in bold on grey background for combinations commonly used in Arabian music, or on black background for ditonic tetrachords. Sums are given on the top right or bottom left corners of each bi-interval element. Equality of the sums follows oblique

<sup>173</sup> Commonly used combinations are concentrated in (and occupy completely) the sector where sum values are comprised between 6 and 8 (both values included) – on black background: ditonic combinations; on black or grey background: Arabian combinations.

parallel lines, from bottom left to top right (or reciprocally). All series with two conjunct intervals found in the commonly used tetrachords are concentrated in the three oblique rows with sums of 6, 7 or 8. Other combinations have sum values below or above.

This is a very strong indicator for homogeneous interval distribution of the intervals within the scale. If we add to all these bi-interval combinations other intervals, to the left or to the right and check those which follow the rules of homogeneity (Fig. 29), we end up having only common tetrachords listed in Fig. 25: 38.

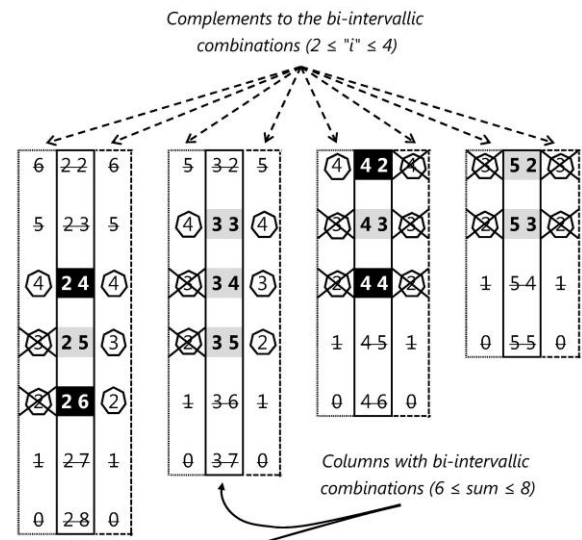

Fig. 29 Complements to the bi-interval elements of common use (black or grey background) on both sides of the elements, in order to obtain one tetrachord on each side.<sup>174</sup>

With a single criterion applied to the intervals of the sub-systems within the fourth, there is a model which is the closest possible to common practice and theory. Furthermore, this rule of homogeneity is the reciprocal of Aristoxenos' *pycnon* rule (see Fig. 30).

<sup>174</sup> After redundant combinations (crossed intervals) are excluded, and by eliminating all combinations that do not comply with the homogeneity rule (which states that the sum of any two conjunct intervals must be such as  $6 \leq \text{sum} \leq 8$ ) and its corollary (complement value to any two conjunct intervals is such as  $2 \leq i \leq 4$  – where  $i$  is the complement value), the only remaining tetrachords in fourths are the commonly used tetrachords in both ditonic (semi-tone based – on black background in the figure) and Arabian music (both grey and black backgrounds).

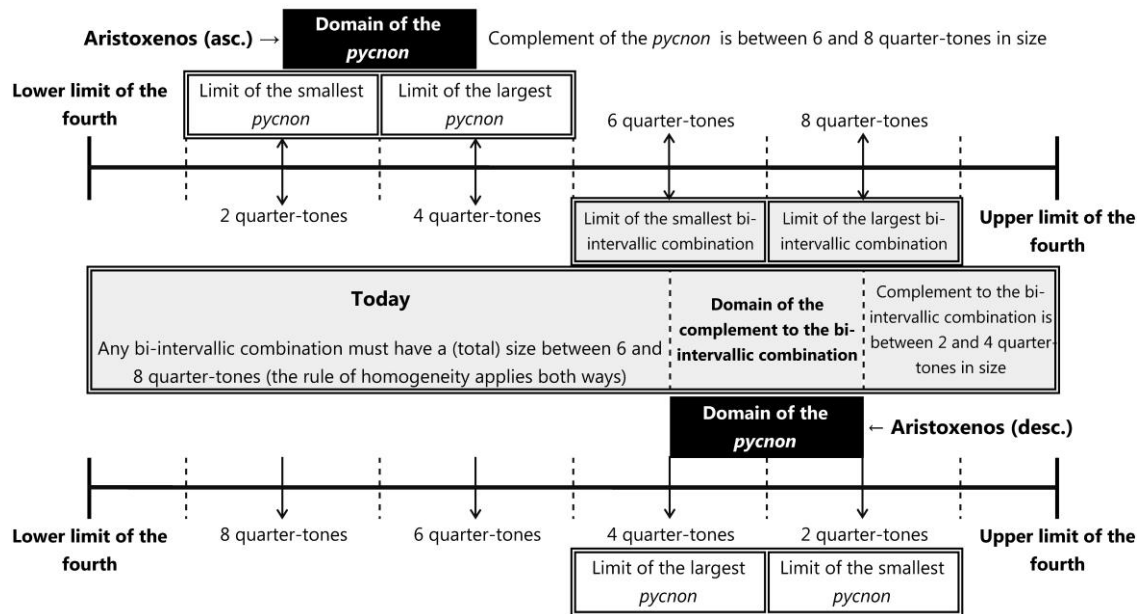

Fig. 30 The homogeneity rule, or reverse *pycnon* rule. If Aristoxenos' tetrachord is falling, the domain of the *pycnon* is the domain of the complement of the bi-interval combination (within a fourth) in today's traditional heptatonic modal music. This applies to all tetrachords of common use in Arabian music, including the chromatic tetrachord *hijāz* (the symmetrical 262 in multiples of the quarter-tone) and its (most probably) original forms in 352 and 253 (the latter is more related to *maqām Hijāz-Kār*).

Aristoxenos' *pycnon* rule says that a *pycnon* (a bi-interval scale element composed of two small intervals within a fourth) must be smaller or equal to the one tone interval.<sup>175</sup>

The rule of homogeneity observed with common tetrachords, which we could also qualify as reverse *pycnon*, says the contrary (Fig. 30). The complement (here of any bi-interval combination inside the fourth) must have the same limitations as those for Aristoxenos' *pycnon*, and the bi-interval combination, although equal to, or greater than the one-tone interval (not a *pycnon* in Aristoxenos), has the same limitation as for the complement of the *pycnon* with Aristoxenos.

<sup>175</sup> See [Mathiesen, 1999], p. 49: "If the interval between the *lichanos* and the *hypate* is smaller than the interval between the *lichanos* and the *mese*, the smaller interval is called a *pycnon*..."; and Mathiesen's figure 51, p. 313. The author gives the *pycnon* a range of 5 quarter-tones, although this would apply to the low diatonic tetrachord of Aristoxenos, and the *pycnon* would then be equal to its complement in the just fourth. The tetrachord with the greatest *pycnon* with Aristoxenos is the "whole-tone color", the tense chromatic tetrachord in Mathiesen with a *pycnon* (composed of the smallest two intervals) equal to the one-tone interval, i.e., smaller than its complement within a fourth. The smallest *pycnon* occurs, according to Aristoxenos, in the enharmonic tetrachord, with a sum value of 2 quarter-tones.

This important difference may have one of the following causes:

1. With our modern music as with traditional forms, such as with the *maqām*, there has been important evolutions diverging from their initial form, which initially, might have been close to Aristoxenos' descriptions.
2. Arabian music and Ancient Greek music were never connected, and the former evolved independently from the latter.<sup>176</sup>
3. Aristoxenos' theoretical description of the music of his time was not accurate or had, notably for his theoretical use of the *pycnon*, no relation with practice.
  - As a corollary: the descending dimension of Ancient Greek theoretical descriptions of scale elements (Aristoxenos' descriptions included), is... theoretical.<sup>177</sup>

<sup>176</sup> The Arabs used Ancient Greek theories (and them extensively – see [Beyhom, 2010b]) and Byzantine music praxis. Separate paths for Ancient Greek and Arabian musics seems, however, unlikely due to the many similar influences on these musics (see notably [Beyhom, 2016]) and due to their interaction.

<sup>177</sup> Another possibility is that this was not accurately translated and explained until now: the issue of the continuity between Ancient Greek and Arabian (and other *maqām*) musics is complex,

APPLYING THE REVERSE PYCNON RULE TO THE FIFTH AND THE OCTAVE

The last filter has shown the most commonly used tetrachord. Consequently, it would be interesting to apply this principle to the fifth, or to the octave. This is simple enough, with the fifth, and consists in adding an interval at one end and at the other of the *genus*, within the rules of homogeneity (Fig. 31), and then verifying the sums of the resulting combinations.<sup>178</sup>

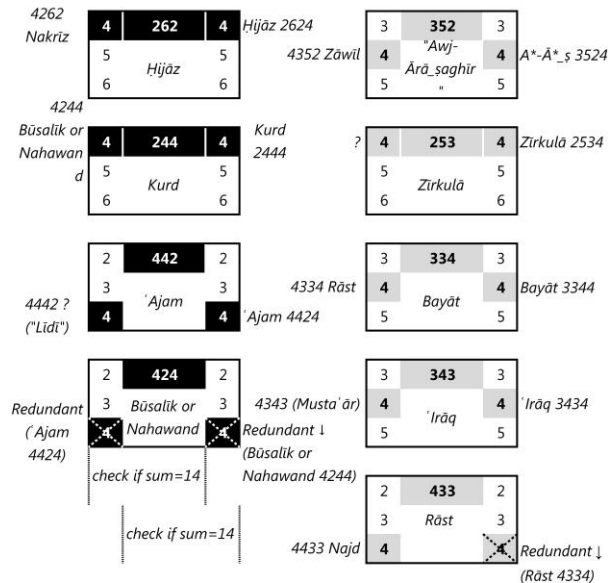

Fig. 31 Extending the homogeneity rule to the fifth: names of *genera* in Arabian music stand below the tri-interval combinations.<sup>179</sup>

As expected, this shows that most of the pentachords resulting from this operation have their

and frequently obscured by ideological biases as shown in [Beyhom, 2016].

<sup>178</sup> This corresponds to a tree-like generative process with additional intervals chosen among the alphabet in order to comply with the homogeneity rule. Sums are checked afterwards to verify if the fifth is reached.

<sup>179</sup> Names of the resulting pentachords in fifth (sum = 14) figure at the sides of the successful combinations (ditonic combinations have a black background – left. Arabian configurations have a grey background – right). Different names for 4244 result from different positions of the tetrachord in the general scale of Arabian music theoretical literature; 3524 exists in one single reference, but is compatible with our present knowledge and understanding of *maqām* music – the conclusion is that common pentachords in Arabian music are based on the fourth + one tone configuration, with one of the successful combinations ([4]253) not found in the reviewed literature but in tune with traditional music.

equivalence in both literature and practice, although some of possible pentachords do not appear in the series.<sup>180</sup>

Fig. 32: 44 shows an example of scale building beginning with the *hijāz* tetrachord. This is very similar to the generation of fifths, although less than half of the combinations (with a black background on the figure) exist in the literature or in the practice, with the remaining scale elements not found in the literature.

Possibilities for some limited hexatonic elements (for example 626262 and 262626 in the figure) also exist.<sup>181</sup>

As a consequence, whenever the rule of homogeneity applies to commonly used genera, its extension to the fifth and octave intervals is either inadequate or too restrictive, although it shows that the full potential of Arabian music, even with such a restrictive criterion, is still not fulfilled.

However, there is a noticeable exception with the *maqām Mukhālīf* which in Arabic means ‘infringer’, which has a limited scale of  $b^- 3 c' 2 d^b 4 e^b 2 f^b$  where the two first intervals breach the rule of homogeneity. There are other *maqām* where conjunct tetrachords may form neighboring semi-tones as for example in the *maqām Nawā-Athar* where the interval/tetrachord distribution is [4] {262} {262} (or a disjunctive one tone interval followed by two *hijāz* tetrachords, where the two neighboring semi-tones (underscored in italics) also breach this rule (when applied to the octave).

This is the main reason why, although the homogeneity rule is a perfect matchmaker for tetrachords, I shall keep, for the following statistical studies in the frame of a fifth or an octave, the initial criteria given in Fig. 25: 38.<sup>182</sup>

<sup>180</sup> See [Beyhom, 2003b], p. 7-13, and Appendix B – these pentachords are either rarely used, or are doubtful.

<sup>181</sup> Most of these do not leave way for a possible combination of two tetrachords and a one-tone interval. The remaining set, *i.e.*, 3524262, 3434262, 2624253, 2624343 and 2624352, are probably in tune with the aesthetic criteria of Arabian music, but may be difficult to perform on the *ūd* (for non-virtuoso performers) in its usual tuning (mainly in ascending fourths).

<sup>182</sup> Also to clarify the effect of each criterion on the outcome of the generative process.

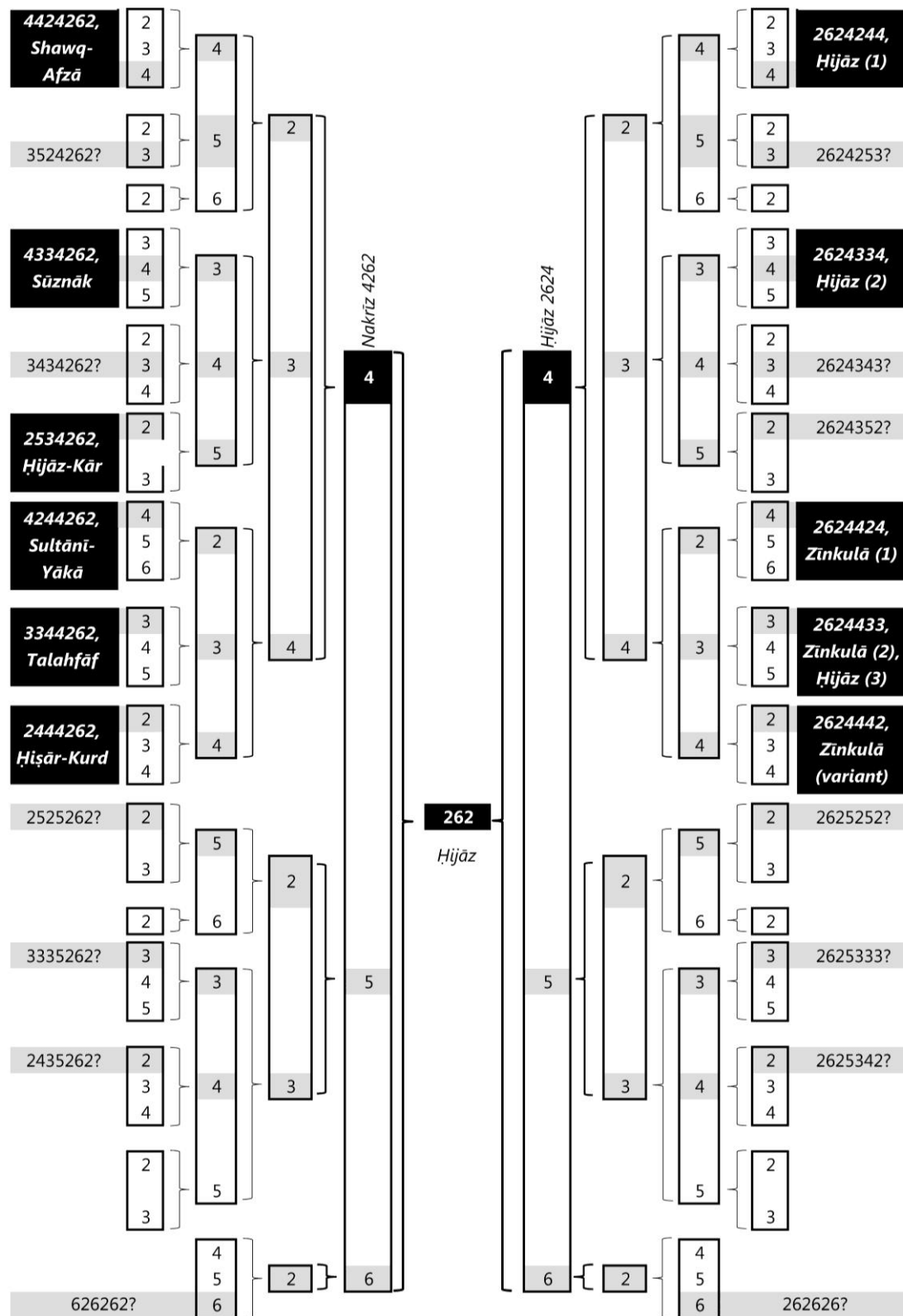

Fig. 32 Extending the homogeneity rule to the octave using tree processing of intervals, on the example of an initial *hijāz* tetrachord. In case of success (the homogeneity rule is respected), intervals figure on a grey background, and names of resulting scales of Arabian *maqām* stand at the side of each attested combination (black background).

A LITTLE INCURSION IN THE EIGHTH-OF-A-TONE MODEL

The reader may be wondering why this study does not give more refined models, such as the eighth of a tone, for example. A first answer was given above and said that the purpose of interval generation was to use the least possible divisions in a containing interval with the utmost number of combinations, according to the principle of economy.

A second answer comes from the definition of the conceptual interval. Any interval in use in a scale should be relatively easily identified,<sup>183</sup> both by performers and listeners alike (this procedure becomes difficult in practice whenever the elementary intervals are smaller than the one-quarter-tone).<sup>184</sup>

However, and as a confirmation of the principle of relative size of intervals within a containing interval, we shall have a quick look at this possibility, in fourth.

When dealing with a new interval model, it must be first determined which are conceptual, elementary, or measurement intervals.

When the measurement interval is one-eighth-of-a-tone, what would be the smallest conceptual interval? Two-eighths-of-a-tone would be too small because it equals a quarter-tone which is too small for being conceptual. A three-eighths-of-a-tone interval, as used by Aristoxenos in his hemiolic chromatic tetrachord,<sup>185</sup> with two conjunct intervals of three-eighths of a tone and one interval of fourteen-eighths – or seven-quarters-of-a-tone, would restrict us to the 17-ET inspired by Urmawī’s theory (Fig. 33: 45, central one-tone interval), with a three-eighths interval equivalent to a *leimma*, an elementary quarter-tone used as an auxiliary interval, and with two possibilities for the *mujannab* interval (see the three one-tone intervals to the right of Fig. 33).

<sup>183</sup> This is different from pitch or interval differences perception and discrimination, and will be further explained in the Synthesis.

<sup>184</sup> Perception of differences of pitches as low as 5 cents (and even as low as 2 cents) are possible through careful listening to pitches close one to the other, an experiment I propose in the accompanying Power Point show to [Beyhom, 2016]. This is however far more difficult in practice performance. While musicians (this includes singers) may well perceive small variations of intonations that they perform, either intentionally or not, it remains that these small variations are not structural, and will not be identified as such even by listeners who can perceive them.

<sup>185</sup> See [Barbera, 1977], p. 311.

On the other hand, four-eighths-of-a-tone is equivalent to one-half-tone, and choosing such a small conceptual interval, we would lose the benefit of having a smaller division of the tone.

As long as we do not want to differentiate conceptual intervals using too small elementary intervals, dividing the tone further than the quarter-tone (with the smallest conceptual interval set to the semi-tone value) would be pointless for the model, but could bring a better approximation of intervals used in practice.

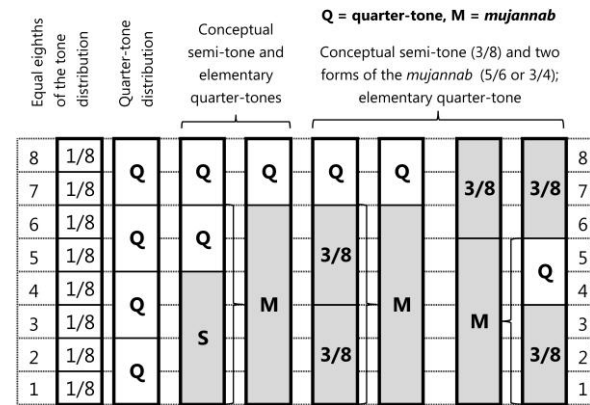

Fig. 33 Modeling the one-tone interval with eighths of a tone.

Fig. 34 shows the graphic results of a generation in eighths-of-a-tone with the smallest conceptual interval being a semi-tone (4/8 of a tone), and elementary intervals being one-eighth-of-a-tone. This leaves space between the semi-tone and the tone for three intermediate intervals of five, six and seven-eighths-of-a-tone.<sup>186</sup>

The optimal number of intervals remains three (NI=3) with changes to the general curve of the graph. With four intervals and a very small increment such as one-eighth-of-a-tone, we have more possibilities than we had with the quarter-tone generation (for example for the case NI=4), but NI=3 remains the optimal value.

If we add the principle of memory to the principle of economy, or the need for performers of traditional

<sup>186</sup> The complete alphabet is, in multiples of the eighth of a tone, 4, 5, 6, 7, 8, 9, 10, 11, 12, 13, 14, 15, 16, with the last value (16) representing the di-tone, which is the largest possible interval (in the frame of a fourth and with the semitone as smallest conceptual interval) in this model: for a complete listing of the results, see Appendix A.

music to memorize the elementary scale divisions of the fourth (or archetypal tetrachords) in order to reproduce them effortlessly while performing, we end up concluding that the eighth-of-a-tone model simply gives too many possibilities, which would also be difficult to distinguish from one another.

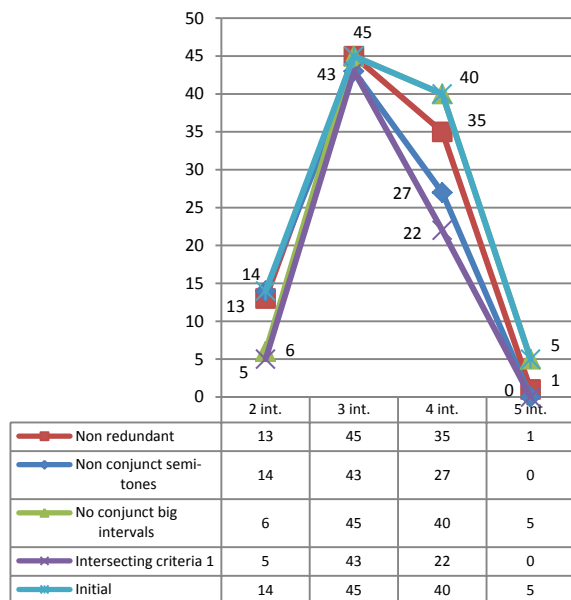

Fig. 34 Statistical results of the generation for a just fourth in eighths of the tone, with the smallest conceptual interval chosen as the semi-tone (= one half-tone).

One would associate the difficulty of perceiving intermediate intervals for the audience and the performer (the eighth-of-a-tone is 25 cents in size, very close to the Pythagorean comma which is approximately 23 cents), with a major difficulty (a huge number of tetrachords to memorize) which introduces a *quasi*-impossibility for the existence of a traditional repertoire based, as already stated, on the memorization and identification of melodic patterns.

To conclude, let us note that within a fourth, the case NI=3 (intervals) is the only one (still) that does not generate redundant sub-systems, a characteristic I have already underlined for the other two models (with semi-tones and quarter-tones). This discussion is continued at the end of next section.

#### COMBINING INTERVALS WITHIN THE FIFTH

Modeling the fifth in semi-tones or with quarter-tones (with the restriction to the semi-tone as the smallest conceptual interval) gives additional

information on the internal structure of containing intervals (Fig. 36 and Fig. 36).<sup>187</sup>

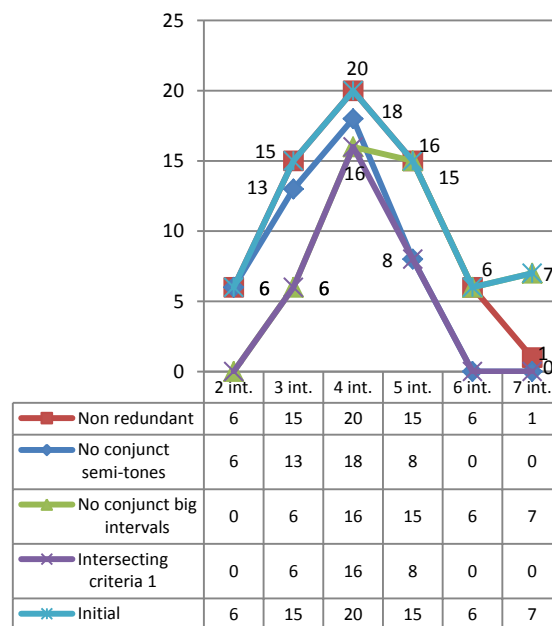

Fig. 35 Graph for the semi-tone generation of the fifth, with the unlimited alphabet.

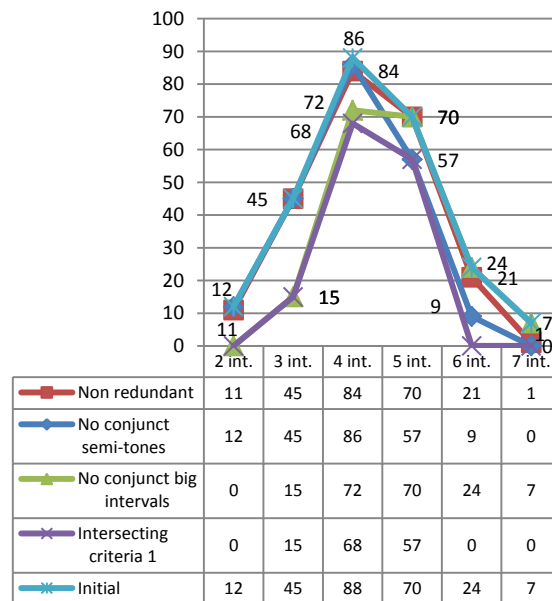

Fig. 36 Graph for the quarter-tone generation of the fifth, with the unlimited alphabet.<sup>188</sup>

<sup>187</sup> The full results for the semi-tone model can be found in Appendix C.

<sup>188</sup> The optimal generations are at NI=4 in both cases (semi-tone and quarter-tone), but in a clearly shaped form for the first (with intersecting criteria), whenever the quarter-tone model's optimal value at NI=4 has a competition at NI=5. The no conjunct semi-tones criterion applies to suites of three or more semi-tones in a

NI=4, in both models, is the optimal value although noticeable differences exist between the two. The optimal value for the semi-tone model is clearly shaped, and accentuated with the application of filters to the sub-systems.<sup>189</sup>

With the quarter-tone model, this optimal value has NI=5 as a competitor, and the filters give the latter a more important role, although less than for NI=4. Another difference is that the semi-tone model generates no redundancies (except for NI=5 which is a trivial case with 5 semi-tones in a row) whenever redundant sub-systems may be found in the quarter-tone model, including for NI=4.<sup>190</sup> As a consequence, the semi-tone model is, within the fifth, more appropriate than the quarter-tone model.

For example, when reducing the results to the limited alphabet of 1, 2, 3 for the semi-tone model, the results (Fig. 37, compare with Fig. 36 above) show that the most effective filter is the disjunct large interval criterion which eliminates sub-systems containing intervals equal to, or greater than 3 semi-tones.

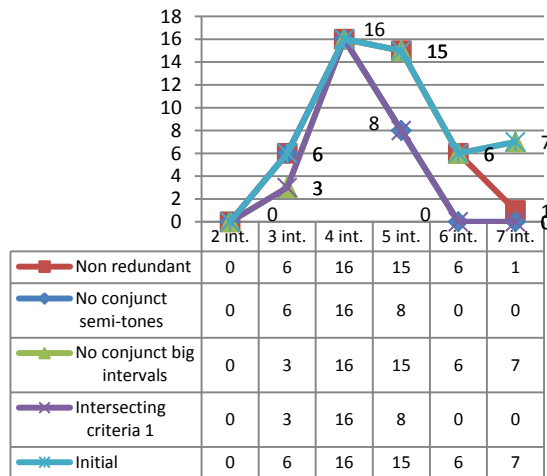

Fig. 37 Graph for the semi-tone model of the fifth with the limited alphabet 1, 2, 3.<sup>191</sup>

row, and the no conjunct big intervals criterion to intervals equal to or greater than 3 semi-tones.

<sup>189</sup> The no conjunct semi-tones criterion applies to suites of three or more semi-tones in a row.

<sup>190</sup> Complete results in appendices B and C.

<sup>191</sup> The shape of the intersecting criteria 1 line is narrower (values for NI=3 are relatively smaller than for an unlimited alphabet) and confirms the optimum for NI=4.

## Discussing the preliminary results

Interval distribution within the fourth or the fifth provides with a preliminary answer to our greater question concerning heptatonism. Combination processes applied to conceptual intervals show that three intervals in a fourth and four intervals in a fifth correspond to an optimal value (a maximum of different polychords for the least possible number of conceptual intervals) which reflects a balance between complexity (smaller interval identifiers such as the eighth of the tone or others, more intervals in a containing interval) and productivity in terms of independent (and fit for their role in music performance) interval combinations.

This applies with or without the filters in resulting sub-systems. These filters reduce possibilities and give a hold on the internal mechanisms of modal music. Interval combinations chosen throughout history can be described and recognized – their positioning and qualitative sizes within the fourth or the fifth is not a coincidence.

Furthermore, as we try to reduce the steps between intermediary intervals (as in the eighth-of-a-tone model of the fourth), the tendency towards a balance of the generations around the (same) optimal value remains, with however quantitative differences between models.

The semi-tone model seems to be best suited to the fifth, rather than to the fourth: the optimal value in the semi-tonal modeling of the fifth is very stable and the angle formed by the two bordering segments of the line is acute and (Fig. 36) accented in the case of a limited alphabet (Fig. 37); this optimal value still exists for the fourth, in the semi-tone model, but with a very limited number of combinations: in this case, only four major (ditonic) combinations may be used by the performer, which is somewhat limited compared to the twelve combinations in the quarter-tone model of the fourth (Fig. 25, p. 38: nine tetrachords are left if we filter the sub-systems with the second set of intersecting criteria).

Twelve (or nine) combinations within a fourth seems a suitable reservoir for modal possibilities, alone or in combination, in performance or as paradigms for a repertoire as it gives the performer good possibilities for modulations, with the fourth as a starting containing interval that he can elaborate further and

further (by modifying its internal structure – or interval composition), and then perhaps expand the span of the melody to the fifth or more.

An eighth-of-the-tone model gives too many intermediate possibilities while adding perception difficulties (for example, an eighth-of-a-tone is much more difficult to recognize than an interval of one-quarter-tone, and the difference between a three-quarter-tone interval and a one-tone interval is much easier to distinguish from the difference between a six-eighths-of-a-tone interval and a seven-eighths-of-a-tone interval).

With the fifth, however, the quarter-tone model becomes too rich,<sup>192</sup> and too complicated. Almost seventy possible combinations are available to the performer, which would be difficult to memorize.<sup>193</sup> It is easier to add a one-tone interval below or above the bordering intervals of the fourth (Fig. 31: 43). This is a process that would give some fifteen interval patterns available within the fifth.

This is a practical means for enriching the repertoire with the least possible number of conceptual intervals. Even then, the semi-tone possibilities of the fifth compete with the potential of this last model. This is mainly due to the fact that the addition of one tone to the fourth reinforces the ditonic nature of interval combinations, as well as the possibilities for bi-fourth configurations (two intersecting fourths with successive ranks – Fig. 38).

Should we start our scale element with a one-tone interval (Fig. 38, left, the one-tone interval equates to the 4 quarter-tones), possible combinations complying with both rules of sum (for the adjacent fourth – in order to obtain a fifth) and the rule of homogeneity are more or less balanced between elements with zalzalian

intervals (five) and elements with (exclusively) ditonic intervals (four).

If we begin our element (ascending from left to right) with a zalzalian interval such as the three-quarter-tone interval (Fig. 38, right), the remaining three intervals cannot make a fourth (their sum is always equal to 11 quarter-tones).

In order to make a fifth, we are in some cases, for example 3344, 3434 and 3524, compelled to complete first the just fourth, then to add to it the one-tone interval, at the end. This process leaves us with only three possible combinations having both fourth and fifth, which is very little when compared to the nine possible combinations in the preceding case in which we have set the first interval to 4, and in which all combination have both fourth and fifth.

In an open process, however, not taking into account the fifth as a necessary step on the way to the octave, the reduced potential of the starting zalzalian three-quarter-tone interval widens up very quickly (before being restricted once again by the octave).

As a preliminary conclusion, we may say that the quarter-tone model is particularly suited to the just fourth, whilst the semi-tone model is better suited to the fifth as a containing interval. Both models, however, show that the number of four or three intervals within a fifth or a fourth, is not coincidental, but it is the result of an optimization process between complexity and expressivity.

A further remark can be made concerning octave systems of scales. What is applicable to the fourth also applies to a combination of two fourths with a one tone interval, or to combinations of fourths and fifths within the octave.

Adding up the numbers of optimized interval repartitions for two fourths (twice three optimal conceptual intervals) + a one-tone interval, the optimal number of intervals for the octave is seven – the same applies to the total optimized number of intervals from the combinations of fourths (three optimal intervals) and fifths (four optimal intervals).<sup>194</sup>

<sup>192</sup> Including redundant sub-systems in the optimal case for NI=4, which differs from all other above seen optimal cases.

<sup>193</sup> Performers find it difficult to memorize more than a few dozens heptatonic scales, even when they are classified with the beginning tetrachord and further combinations in Arabian theory. Modes may be taken as belonging to a family whose main characteristic is determined by the lowest tetrachord – this is a method which makes it easier to remember *maqāmāt* (pl. of *maqām*). However, this consists only of some 30 basic scale combinations. If such an arsenal is needed in order to memorize 30 scales, it seems clear that memorizing 70 pentachords, with a subsequent and much greater number of octave scales, is simply an impossible task for the common musician.

<sup>194</sup> This is a well-known process in Ancient Greek and in Arabian theory. An example is given in details in [Beyhom, 2003a], p. 301-312.

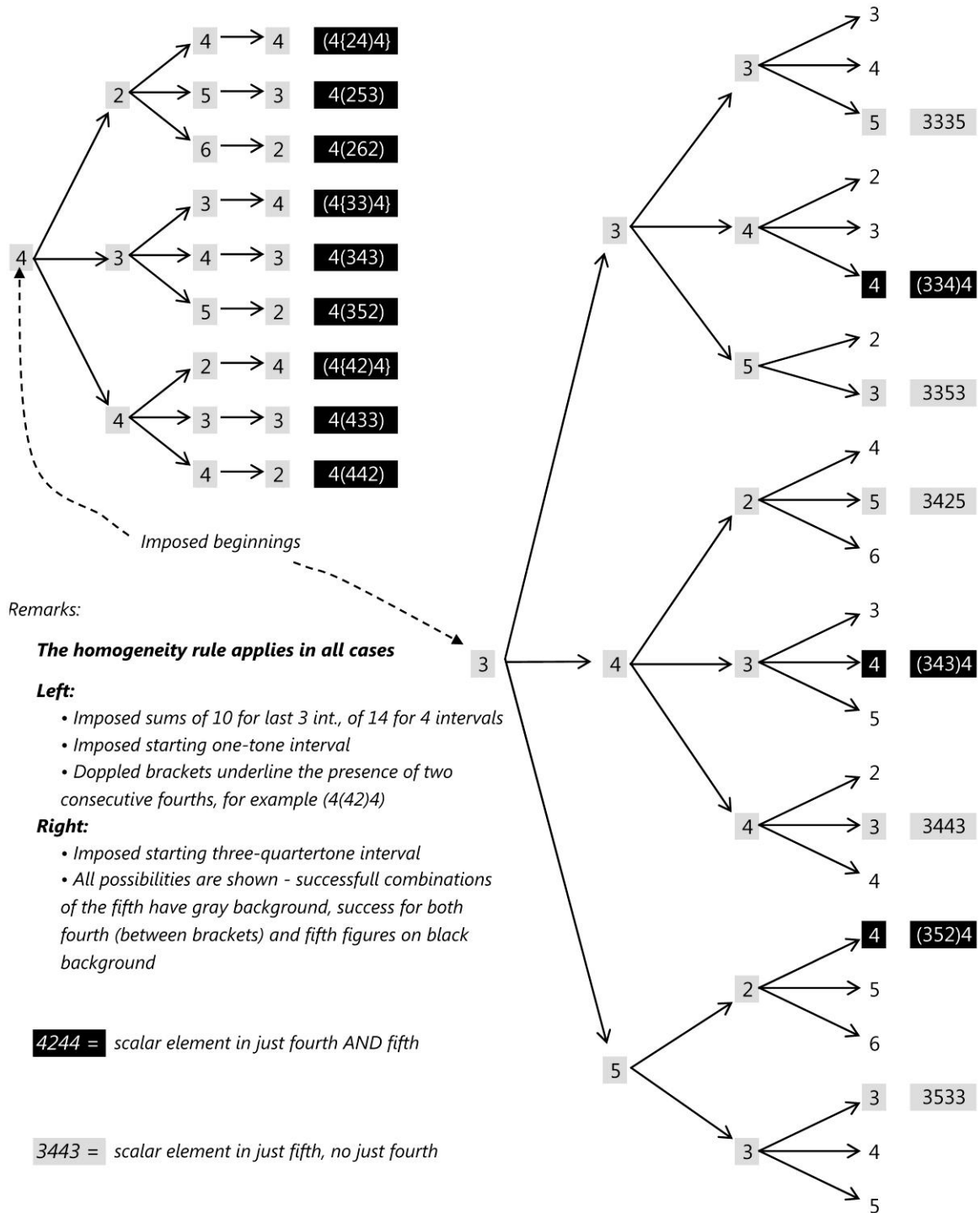

Fig. 38 Modeling the fifth with the one-tone (left) then three-quarter-tones (right) intervals initial conditions and the homogeneity rule.<sup>195</sup>

<sup>195</sup> Beginning with a one-tone interval (left) increases the number of regular (and ditonic) fourths and fifths, as well as bi-fourth combinations within the fifth. Starting with a zalzalian interval such as the three-quarter-tones (right) lessens the possibilities for a fourth/fifth combination, as well as for bi-fourth configurations.



Further criteria such as searching for fourths and fifths from the first interval of each sub-system, work in the same way, except that sub-systems are not discarded, but simply counted.<sup>202</sup>

Further: in this study, as for the statistical studies of the fourth and the fifth, I extend the definition of the conceptual intervals beyond the restricted alphabet<sup>203</sup> (2, 3, 4, 5 and 6 quarter-tones in the quarter-tone model). Thus, the smallest number of conceptual intervals to an octave – or NI – is one, and the largest NI is equal to 12 (Fig. 43: 51 for an example of results in the semi-tone model), or 12 semi-tones in a row (or the smallest conceptual interval twelve times in a row).<sup>204</sup>

Intermediate cases (*i.e.*, NI = 2, 3, 4, 5, 6, 7, 8, 9, 10 and 11 conceptual intervals to the octave) have an intermediate behavior, with a tendency to concentrate larger intervals for smaller values of NI, and semi-tone suites of intervals for larger values of NI. This is self-evident from the cases for NI=1 and NI=12, but two further examples will help the reader better understand the phenomenon:

→ same, but only for two consecutive semi-tones in the scale (sub-system). A cross-criterion with logical “AND” means that both conditions are met; a “\min AND \max” sub-system is a scale with no suites of 2 semi-tones or more AND no suites of intervals greater or equal to the maximum interval (generally the one-and-a-half-tones interval). The “OR” logical expression works in a more complex way. As a last example: sub-system (2 2 4 2 4 2 2 4 2) with nine intervals (in quarter-tones) to the octave meets the criterion “min” (it has two concomitant intervals of semi-tone – underlined above – in two positions of the scale), but not the “umin” criterion (3 adjacent semi-tones): its ninth de-ranked sub-system will meet this criterion, as 2 2 2 4 2 4 2 2 4 comprises a suite of three successive semitones in first position of the scale (beginning with the first interval).

<sup>202</sup> Other, more refined filters and criteria are used in Modal systematics, some of which are explained at the beginning of Appendix I (download from <http://nemo-online.org/articles>), and further in [Beyhom, 2003c].

<sup>203</sup> These intervals are too large, since they are greater than the one-and-a-half-tones interval and as such cannot be considered, ultimately, as conceptual intervals. However, the aim of the statistical study consists partly in determining the boundaries of the alphabet of these conceptual intervals.

<sup>204</sup> The self-evident case for NI=1 appears only in this preliminary generative process (graphs of Fig. 43 to Fig. 46). See Appendix D for the list of the Hyper-systems for the semi-tone generation with the complete alphabet of intervals.

➤ NI=2 in Fig. 43 generates six different hyper-systems in the semi-tone model which are 1 11; 2 10; 3 9; 4 8; 5 7; 6 6. In turn they generate unique systems (identical to the hyper-systems) with two sub-systems for each configuration (there are only two possibilities for combining two numbers, here taken as a and b: a b and b a). System 6 6 is fully redundant (this means that whatever combinatory process (de-ranking included) is applied to its intervals, we end up having the same configuration because all intervals are of the same class). The total number of generated independent<sup>205</sup> sub-systems for the entirety of hyper-systems for this case (NI=2) is consequently equal to 11 (Fig. 43, var. NSS\_NR).

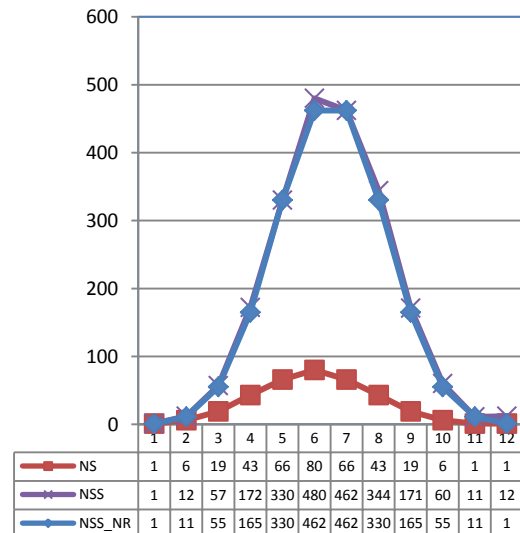

Fig. 43 Systems and sub-systems in an octave, from the initial generation and filtered for redundancies – semi-tone model. Full alphabet.<sup>206</sup>

➤ When NI increases, the largest possible intervals become smaller in size: for NI=3 with 19 systems, (same figure) for example, the largest possible interval is the ten-semi-tones interval which appears in the first hyper-system 1 1 10 (or two intervals of one-semi-tone in a row and one ten-semi-tones interval).<sup>207</sup> The size of the

<sup>205</sup> *i.e.* non-redundant.

<sup>206</sup> NS = number of systems; NSS = number of sub-systems; NSS\_NR = NSS with redundant sub-systems excluded.

<sup>207</sup> The reader may wonder how to read and concatenate intervals greater than ‘9’, here semi-tones: in such case, it suffices to change the basis of numeration from decimal to duodecimal (see [Anon.

largest interval decreases regularly with the increase of the NI, and reciprocally that is if we increment NI by one unit, the largest interval generated is one-semi-tone smaller than for the preceding generation (with a smaller NI). When we get closer to the upper limit of NI, the largest generated conceptual interval has decreased in such a way that only small intervals are generated: for NI=11, for example, we obtain one single hyper-system of 1 1 1 1 1 1 1 1 1 1 2 (10 semi-tones in a row and one one-tone interval), which still generates one unique (identical) system, with however eleven different subsystems generated by the de-ranking process which are:

- 1 1 1 1 1 1 1 1 1 1 2
- 1 1 1 1 1 1 1 1 1 2 1
- 1 1 1 1 1 1 1 1 2 1 1
- 1 1 1 1 1 1 1 2 1 1 1
- 1 1 1 1 1 1 2 1 1 1 1
- 1 1 1 1 1 2 1 1 1 1 1
- 1 1 1 1 2 1 1 1 1 1 1
- 1 1 1 2 1 1 1 1 1 1 1
- 1 1 2 1 1 1 1 1 1 1 1
- 1 2 1 1 1 1 1 1 1 1 1
- 2 1 1 1 1 1 1 1 1 1 1

Consequently, the last case (NI=11, Fig. 43) generates, with one and only hyper-system which is identical to the one and only system it generates, the same number of independent (non-redundant) sub-systems as with NI=2 above (Fig. 43, var. NSS\_NR).

This is a first indicator of symmetry for generations with different NI, which is obvious in Fig. 43 (var. NSS\_NR) which shows the statistical results of a full scale generation in the semi-tone model of the octave. Values around NI=6 are symmetrically placed for the numbers of systems, (var. NS) however, this symmetry does not apply to hyper-systems (Fig. 45: 56, var. NH: var. NSSU\_NR is explained below).

→ “Duodecimal”, 2017] for more explanations), assigning letters ‘A’ and ‘B’ for instance to intervals ‘10’ and ‘11’: hyper-system 1 1 1 10 would be then transcribed, in this new basis and in concatenated form, as ‘11A’; the same applies for the quarter-tone model, with basis 24; in the following explanations, however, all interval numbers have been kept in the decimal basis, for the sake of clarity.

- As a next step after determining the numbers of sub-systems, we exclude redundant sub-systems from the whole set (Fig. 45 and Fig. 46: 56 – this also shows the numbers of hyper-systems). Redundant sub-systems occur whenever an interval configuration is repeated twice or more in order to cover the complete range of intervals within a system. System 4 4 4 in the semi-tone model (three – or NI=3 – successive di-tones which form an octave) is completely redundant, as any de-ranking process gives the same combination as the original one (this is a mono-interval element repeated 3 times in order to form an octave).
- Another example is the one-tone scale used by Debussy, 2 2 2 2 2 (NI=6), which is also completely redundant. More elaborated semi-redundant systems (which generate a limited number of sub-systems – such as Messiaen’s scales with limited transposition) exist, such as 1 1 2 1 1 2 1 1 2 containing three successive three-interval identical combinations of two conjunct semi-tones and one one-tone intervals (1 2 1 1 2 1 1 2 1 and 2 1 1 2 1 1 2 1 1 are independent sub-systems of the latter). There can only be in this case three distinct sub-systems (scales).<sup>208</sup>
- Results for sub-systems are then expressed, for both generations (*i.e.*, with the complete or with restricted alphabets), through the Unitary number of non-redundant sub-systems, or the total number of non-redundant sub-systems divided by the corresponding NI (see for example Fig. 47: 56 and Fig. 48: 57). This

<sup>208</sup> As a general rule, scales with a NI as a prime number may not generate redundant sub-systems unless NI divides the sum of elementary elements within the scale (12 for the semi-tone model and 24 for the quarter-tone model). This is due to the characteristics of these numbers as explained in note 170: 40. For NI=2, with 2 being the second prime number (which divides itself and 1 only after 1 (NI=1 is a trivial case), two divides twelve and twenty four. As a consequence, there is a fully redundant system for NI=2, composed of two tri-tones (6 6 in semi-tones, or 12 12 in quarter-tones – for the latter, read twelve and twelve – or ‘C C’ in the duo-decimal basis as explained in footnote 207). The same applies for NI=3, 4 or 6, with hyper-systems 4 4 4, 3 3 3 3 and 2 2 2 2 2 2 in the semi-tone model – redundant sub-systems are further explored in Appendix G.

process is explained in details in the following section.

- To the results of the previous process, we apply then the two following filters and keep track of the results for both, as well as for the unitary numbers of sub-systems (Fig. 47 *sq.*,<sup>209</sup> with these filters, successful combinations are kept, not excluded):<sup>210</sup>
  - Firstly find all sub-systems with a fourth starting with the first interval that we shall call a direct fourth. This limitation is due to the fact that a fourth, in second position, for example, in a sub-system is the first fourth of the lower ranking sub-system (by a de-ranking process).<sup>211</sup> The values on the graphics (var. NSS5U\_NR, beginning with Fig. 47) indicate that the filtered remaining sub-systems have each a direct fifth (which starts with the first interval of the sub-system – these are labeled NSS5U\_NR on the graphs, for ‘Numbers of Sub-Systems in 5<sup>th</sup> Unitary, Non redundant’). As long as we are searching for statistical results, this is the same as searching for direct fourths, as a complement of the fifth (the fourth) can be obtained by de-ranking the sub-system four times.<sup>212</sup> This filter keeps the filtered sub-systems, and excludes the others (as if we excluded all sub-systems that do not

<sup>209</sup> Starting with these graphs, systematic comparison is undertaken between the two models (semi-tone and quarter-tone).

<sup>210</sup> From this point on, only generations with a restricted alphabet are shown in the body of the article. For generations with the complete alphabets, with the exclusion of the one quarter-tone interval for the quarter-tone model, see Appendix E.

<sup>211</sup> In the quarter-tone sub-system 3(244)362, for example, the fourth in second position (the 244 in brackets) is the first fourth of (244)3623, which is the next sub-system resulting from the de-ranking process.

<sup>212</sup> This means that for each sub-system having a direct fifth, there is always a corresponding sub-system (which is obtained by de-ranking four times the initial sub-system with the direct fifth) with a direct fourth. In the previous sub-system (see previous footnote), the direct fourth is 244 with for complement 3623 fifth. De-ranking three times (*i.e.*, beginning with 2443623, 4436232, 436232, 3623244) we get a sub-system with a direct fifth 3623, but not necessarily a direct fourth. If we de-rank four times the last sub-system beginning with a direct fifth, we get the initial sub-system 2443623 with a direct fourth, but no direct fifth. Consequently, the number of sub-systems containing a direct fifth (in any of the generations shown) is equal to the number of sub-systems containing a direct fourth.

have a direct fourth); original results with unitary sub-systems are however kept for further comparisons.

- The next step consists in verifying for systems with a direct fourth enclosed in a direct fifth (labeled FFU\_NR, or ‘Fourth in a Fifth, Unitary and Non-Redundant’), for example in {(442) [4]}(352). With the latter, the direct fourth is 442, and the direct fifth is {442[4]} with the complement of the fourth within the fifth being the one-tone interval, or [4] – in such cases, the configuration of the sub-system is equivalent to a combination of two fourths and a one-tone interval (4<sup>th</sup> + T + 4<sup>th</sup> – see example above). This filter is named the direct Fourth in a Fifth, or FF, process (same figures as above).
- Now that we have representative graphics for the overall statistical distribution of sub-systems, including the ones containing direct fourths and/or fifths, we may apply, separately, as a first approach, two additional filters which are very close to the ones used for the fourth and fifth containing intervals explored in the previous sections:
  - The conjunct semi-tones criterion (which operates here for three or more semi-tones in a row – (Fig. 51: 58 and Fig. 52: 58).<sup>213</sup>
  - The conjunct large intervals criterion, which operates for intervals greater or equal to the one-tone-and-a-half interval (3 in semi-tones, 6 in quarter-tones – Fig. 51: 58 and Fig. 52: 58).<sup>214</sup>
- The final stage is reached by applying the last two filters simultaneously (Fig. 53: 59 and Fig. 54: 59).

All these graphics and filtering procedures are discussed in the next sections.

<sup>213</sup> The extension from two to three semi-tones (in a row) in this filter allows for the existence of bi-fourth configurations (within a scale) with bordering semitones, for example two *hijāz* conjunct tetrachords – or (2 6 2) (2 6 2) in quarter-tones.

<sup>214</sup> This filter is more permissive than the one used for the fourth and the fifth, due to the fact that some (very few, and mostly questionable) scales found in literature include conjunct one-tone and one-and-a-half-tones intervals – see [Beyhom, 2003b], notably p. 33, 38 and 42.

### *From hyper-systems to unitary sub-systems: an example based on the semi-tone model*

We shall begin our investigation of the octave with a full scale generation in the semi-tone model using the complete alphabet, from the one-semi-tone interval to the twelve-semi-tone interval. A complete generation includes statistical results for numbers of conceptual intervals NI distributed between NI=1 to NI=12. The case for NI=1 (one single octave interval in the system) is shown on the first four graphs only.

#### A. GENERATION OF OCTAVE SYSTEMS WITH THE FULL ALPHABET OF CONCEPTUAL INTERVALS

This first example of octave generation in semi-tonal conceptual intervals shows that the results in numbers of systems for NI=1 have a symmetrical correspondent which is NI=11 (Fig. 43: 51). The optimal value for systems with this process is reached for NI=6, for which the number of systems is at its highest value (80 systems are produced for this number of conceptual intervals to the octave and 480 sub-systems). Furthermore, results (for systems – NS – still) for intermediate values of NI (from NI=2 to NI=10) are symmetrically distributed around the optimal value (for NI=6).

However, the non-redundant sub-systems are also distributed symmetrically around the bi-optimal at NI=6, 7. If we look at the numbers of hyper-systems (NH) generated by this process (Fig. 45: 56)<sup>215</sup>, they have a distribution which is different from the distribution of the number of systems (NS). This is because and, although for example NI=4 generates the largest number of hyper-systems (in this case 15), each hyper-system in this configuration can generate a limited number of systems since there are only a small number of positions (four in this case) in which conceptual intervals may be combined in order to obtain systems,<sup>216</sup> whenever the corresponding (symmetrical in terms of numbers of generated

systems) case is NI=8, which generates a lesser number of hyper-systems and have the same number of systems because of its eight (twice more as for NI=4) possible positions for conceptual intervals. In the latter case, there are fewer possibilities for different classes of intervals within the hyper-system,<sup>217</sup> but more positions (eight) that conceptual intervals can fill.

This explains why the results are balanced although we still have no explanation for the perfect symmetry of the resulting numbers of systems around NI=6.<sup>218</sup> The symmetry equally applies for the Unitary Number of Sub-Systems (NSSU), from which Non-Redundant sub-systems have been excluded (NSSU\_NR on the graph in Fig. 45: 56). The latter is a weighted variable which reproduces the effect of the principle of economy explained in the first section of the second part of the article.

If we transpose this principle to the statistical generative models explored here, an increase of complexity (i.e., of the number of conceptual intervals, or NI, needed in order to compose the octave), even if it produces more sub-systems must bring a relative increase of the latter. In other words, each supplementary interval needed to compose the octave must be justified by a proportional (qualitative) increase of the number of generated sub-systems, not only by augmentation of the total (quantitative) number of sub-systems.

This proportional increase criterion can be included from the results by dividing the total number of sub-systems, for each NI, by the number of conceptual intervals needed in order to complete the octave, that is by NI itself, which gives us  $NSSU = NSS/NI$ . This variable (NSSU) is equivalent to NS (or the total number of systems for each different NI),<sup>219</sup> and gives us, as such, no additional information.

<sup>215</sup> The shape of the broken lines representing distributions of NS and NSSU\_NR in Fig. 45: 56 can be compared to a regular normal (law of) distribution in statistical studies, or bell-type distribution – the results do not correspond, however, to the analytical expression of that law.

<sup>216</sup> See Appendix D for a full list of hyper-systems for this generation, together with the numbers of systems and sub-systems in each hyper-system.

<sup>217</sup> For NI=8 (where as the first hyper-system is 1 1 1 1 1 1 1 5) we may not use intervals larger than the five-semi-tones, whenever we may use intervals as large as the nine-semi-tones interval for NI=4 (where the first hyper-system is 1 1 1 9 – or three one-semi-tone and one nine-semi-tones adding up to 4 conceptual intervals the sum of which equals to twelve half-tones, or the octave).

<sup>218</sup> This *lacuna* is due to my own limitations in statistical and mathematical sciences. Any explanation of the phenomena by a specialist in this field would be greatly appreciated.

<sup>219</sup> Because NSS is, by definition, equal to NS x NI.

However, if we exclude the redundant (R) sub-systems<sup>220</sup> from the total number of sub-systems, we obtain the final (weighted) variable  $NSSU\_NR$  which is equal to the total number of sub-systems minus the number of redundant sub-systems for each NI, the whole being divided by NI itself, or  $NSSU\_NR = (NSS - R)/NI$ .  $NSSU\_NR$  is, as a result, a compound variable that integrates the principle of economy. It shows the need for each supplementary conceptual interval used in a scale to be justified by a proportional increase in the number or resulting sub-systems.

In the graph of Fig. 45: 56 the values for  $NSSU\_NR$  are close to the ones expressing the total number of systems (as there are few, comparatively, redundant sub-systems in each case, except for NI=12 which is a trivial case), and the corresponding broken line is also symmetrical around NI=6.<sup>221</sup>

#### B. GENERATION OF OCTAVE SYSTEMS WITH REDUCED ALPHABET OF CONCEPTUAL INTERVALS 1, 2, 3, COMPARED TO FULL ALPHABET GENERATION

When we limit the largest interval in the semi-tone model to the one-and-a-half-tones interval (limited alphabet), the symmetry observed for systems and sub-systems in the previous generation disappears (Fig. 44: 55 and Fig. 46: 56 – symmetry shifts around the bi-optimal values NI= 7, 8, in Fig. 44, for non-redundant sub-systems) and the optimal value NI for systems (NS) shifts to the value NI=7 instead of NI=6, while smaller values for NI (up to 3) simply do not generate any scale element.

The smallest productive value of NI in this generation is NI=4, with the unique hyper-system/system/sub-system 3 3 3 3.<sup>222</sup> Furthermore, the number of pentatonic (with NI=5) systems diminishes

<sup>220</sup> These redundant sub-systems are useless in the traditional concept of modal music.

<sup>221</sup> The use of the Unitary Number of Non Redundant Sub-Systems in the previous generations for the fourth and the fifth would have emphasized the optimum at NI=3 for the fourth, and at NI=4 for the fifth. The lesser numbers of results for the previous generations have allowed us, however, to try to go deep inside the structure of the fourth and the fifth, without having recourse to the weighted variables used for the octave generations. In the latter case, it would be too long a task because of the very important numbers of sub-systems involved.

<sup>222</sup> In this system, three out of four sub-systems obtained by de-ranking are redundant. Consequently, this makes of it the unique sub-system.

considerably,<sup>223</sup> and values of NS and  $NSSU\_NR$  (Fig. 46: 56) for slightly larger values of NI (NI=6 to NI=8) are also considerably reduced when compared to those of the full generation in Fig. 45, whenever results for still larger values of NI are less affected.

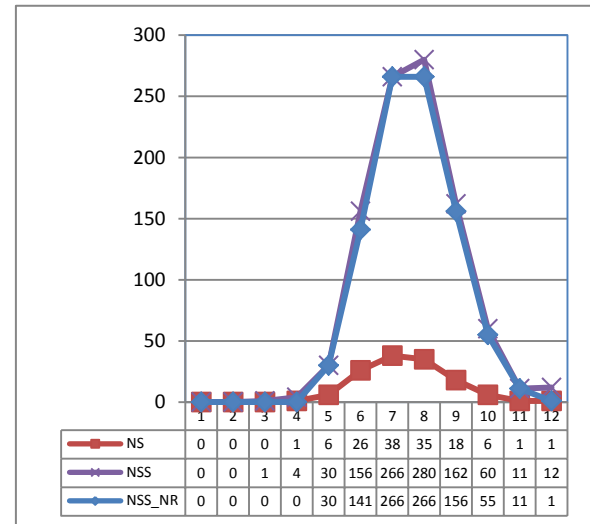

Fig. 44 Systems and sub-systems in an octave: restricted alphabet (1, 2 and 3 semi-tones only).

Octatonic systems (NI=8) compete with the heptatonic models (NI=7) for the optimal value (especially in Fig. 44, where the numbers of sub-systems are not weighted) and, beginning with NI=9, generations are non-economical in all reviewed cases and figures, which means that increasing the number of conceptual intervals to more than eight in the octave gives a rapidly decreasing number of new systems.<sup>224</sup>

Comparing Fig. 45 and Fig. 45: 56, with Fig. 43: 51 and Fig. 44: 55 also shows that there is no direct correlation between sub-systems and systems. The optimal values are still, however, restricted to a limited number of possibilities, from NI=6 to NI=8.

<sup>223</sup> With a limited alphabet, the two pentatonic hyper-systems come to 12333 and 22233 (see Appendix D). Only the last one allows for a simultaneous direct fourth and fifth configuration, or fourth in a fifth. In this case, the chosen alphabet can for example be extended to the di-tone (4), a step permitting the usage of four additional hyper-systems (namely 11244, 11334, 12234 and 22224), and multiplies by five the reservoir of systems (22224 is a poor candidate in this case as it generates one single system), and by four the reservoir of sub-systems which include a fourth in a fifth.

<sup>224</sup> These results encourage questions about properties of numbers and their relations with the models in use.

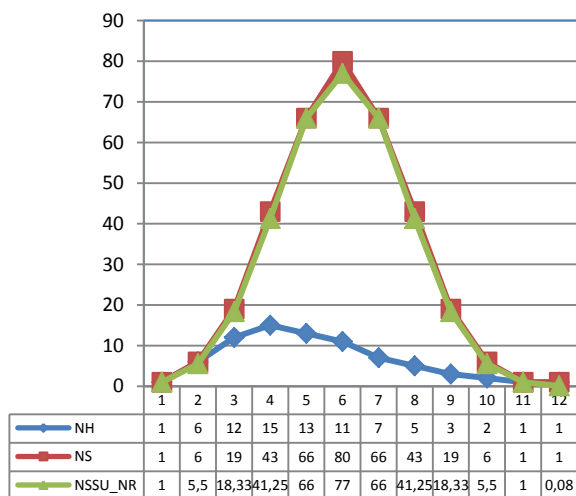

Fig. 45 Hyper-systems and systems in an octave: unrestricted alphabet in multiples of the semi-tone – as in previous figure (alphabet = 1 to 12).<sup>225</sup>

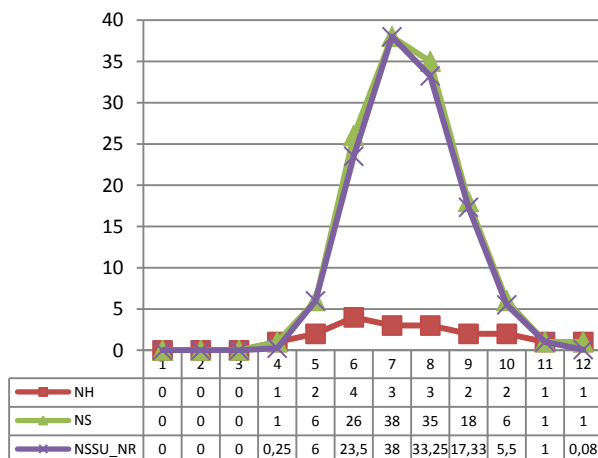

Fig. 46 Hyper-systems and systems in an octave: restricted alphabet in semi-tones (alphabet = ‘1, 2, 3’).

As a next step, we shall include the direct fourth (or direct fifth) and the fourth in a fifth filters in our models, and compare the results with those of the quarter-tone model.

### Comparing generations in the semi-tone and quarter-tone models: looking for direct fourths and fifths

The direct fourth (*i.e.*, a fourth starting with the first interval of a sub-system) and the fourth in a fifth

<sup>225</sup> NH=Number of Hyper-systems (for each NI), NS=Number of Systems, NSSU\_NR is the Number of Sub-Systems in Unitary weighting with the Redundant sub-systems excluded (NR=non-redundant).

(see above) criteria may serve as supplementary filters for comparison with the remaining sub-systems. These filters are given at Fig. 47 (semi-tone model) and Fig. 48: 57 (quarter-tone model), applied to the results of the realistic generation in the preceding stage, *i.e.*, to the unitary non-redundant<sup>226</sup> sub-systems with the limited intervallic alphabet of Fig. 44: 55 and to its equivalent in the quarter-tone model.<sup>227</sup>

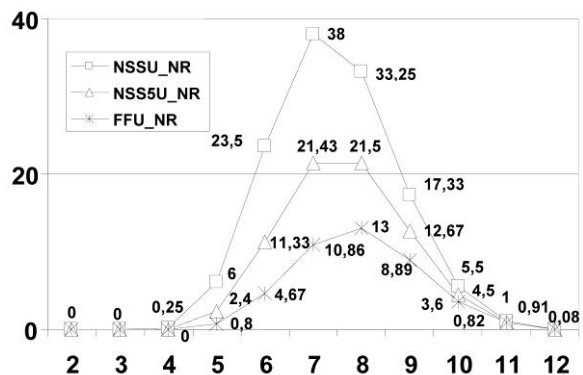

Fig. 47 Unitary non-redundant sub-systems in an octave, restricted alphabet (alphabet = 1, 2, 3) – semi-tone model.<sup>228</sup>

A few remarks may be made about these results:

- The optimal value for the Unitary sub-systems occur, in both models, for NI=7,<sup>229</sup> although in the quarter-tone model this optimal value has a serious competitor for NI=8, with the latter being also the optimum for numbers of sub-

<sup>226</sup> Redundant sub-systems have a limited role in the quarter-tone model. Their weight in proportion to the total number of sub-systems is around 0,5%, whenever it is around 3% for the semi-tone model (with the exception for NI=12, with all sub-systems being redundant). The qualitative results (optimal placements) are consequently not strongly affected by this criterion, in particular for the quarter-tone model, particularly for NI=7 (no redundancies).

<sup>227</sup> The results in the following figures relate only to the restricted alphabet in order to give the most pertinent information. Graphic results for generations with the full alphabet are shown for both models, in Appendix E. Synoptic results for the quarter-tone model (full alphabet) are listed in Appendix F.

<sup>228</sup> NSSU\_NR is the Number of Sub-Systems in Unitary weighting with the redundant sub-systems excluded (NR=non-redundant). NSS5U\_NR is the Unitary number of Non-Redundant Sub-Systems with a direct fifth (or fourth). FFU\_NR sub-systems include a direct fourth in a fifth. See Appendix E, FHT 1: 74 (for “Figure Hors Texte 1, p. 74”= “Plate 1, p. 74”) for the full alphabet generation.

<sup>229</sup> The full alphabet generation shows a maximal NSSU\_NR value for N=6. All other optimal (NSS5U\_NR and FFU\_NR) occur for NI=7 – see Appendix E, FHT 1: 74. In all the graphs, some of the results are corrected to the first decimal place.

systems including a direct fourth (or fifth), or a fourth in a fifth<sup>230</sup>.

- The ratio of unitary sub-systems in the quarter-tone model (Fig. 48: 57, var. NSSU\_NR) to the corresponding sub-systems in the semi-tone model (Fig. 47: 56, var. NSSU\_NR) is about 20 to 1, whenever this proportion diminishes, for sub-systems with the fourth or the fifth (NSS5U\_NR – around 10 to 1), it is even less for the fourth in a fifth criterion (6 to 1 for the latter). This means that, although the semi-tone model generates considerably fewer sub-systems, the proportion of sub-systems in this model with direct just fourths, or combined fourths and fifths (fourth in a fifth criterion), is larger than in the quarter-tone model. However, the optimal value for these sub-systems occurs for NI=8. This is because larger numbers of NI work in favor of increased numbers of semi-tones in a scale. In turn, this applies in favor of the presence of fifths or fourths in a scale.<sup>231</sup>
- All results for values of NI around the optimal value decrease in an almost exponential manner (for values of NI less than, or equal to, six, or greater than, or equal to, nine). This means that optimal generations are concentrated for values of NI between (and including) six and nine, which gives us a preliminary answer to our initial question in the introduction to this article.

These results are, however, still not completely satisfactory, as they do not clearly show the expected optimal value for N=7. Let us remember that sub-systems in these generations may include tri-interval suites of semi-tones, or large conjunct intervals of the second, both of which do not fit with the aesthetics of modal traditional music.

<sup>230</sup> This would explain (see also the Synthesis) the tendency of Arabian modes to use frequently, as with *maqām Ṣabā* (see for instance [Beyhom, 2016], the discussion on Curt Sachs theory of the scale and the counter-example of *maqām Ṣabā* in Chapter III) and others, non-octavial scales which come short from the octave (“lo” or “lower than the octave” systems), and with no direct fourth or fifth. The (almost, as the smallest interval is the semi-tone) full alphabet generation shows a steady optimal value for NI=7, shared in the case of FFU\_NR with NI=8 (Appendix E, FHT 5: 75).

<sup>231</sup> Semi-tones combine easily in the one-tone interval, as well as in the fourth or the fifth – see also Fig. 38: 49 and section “Discussing the preliminary results” above.

- The results of the application for these complementary criteria are dealt with in the following section.

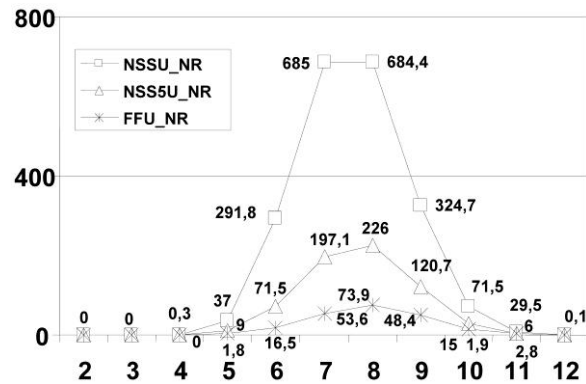

Fig. 48 Same as above, but for the quarter-tone model (alphabet = 2, 3, 4, 5, 6 quarter-tones) – see FHT 5, p. 75<sup>232</sup>, for the (nearly) full alphabet generation.

### Using conjunct interval filters

As a complementary step towards a better understanding of heptatonic scales, excluding conjunctions of small or large intervals from the previous resulting sub-systems, seems to be a suitable filtering criterion.

I have already shown in the sections dedicated to models of the fourth and the fifth, conjunctions of semi-tones are rare in heptatonic scales, and occur mainly between two conjunct tetrachords. The extension of the filter to three semi-tones in a row (which seems to be a non-existent combination in the scales of traditional music as we know it today)<sup>233</sup> makes a good aesthetical criterion when searching for generative optima (Fig. 49 and Fig. 50: 58).

This filter is called ‘\umin’, or exclude ultra-minimal combinations – here of three – semitones in a row.

In Fig. 49 and Fig. 50, the results for the ‘\umin’ filter are shown separately: they are independent from the ‘\max(6)’ – or ‘\max(3)’ – filter, with inversed influences on the curves (Fig. 51 and Fig. 52, p. 58 for the latter).

<sup>232</sup> Reminder: for “Figure Hors Texte 5, p. 75” = “Plate 5, p. 75”).

<sup>233</sup> Ancient Arabian theory and practice seem to exclude these as well – other Ancient forms of music must still be thoroughly checked for conformity with this criterion.

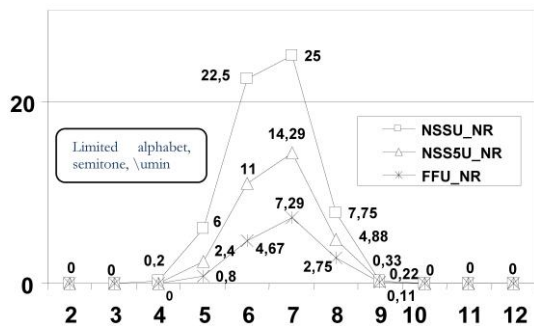

Fig. 49 Unitary non-redundant sub-systems in an octave, restricted alphabet – semi-tonal model with sub-systems containing tri-interval (or more) suites of semi-tones excluded.<sup>234</sup>

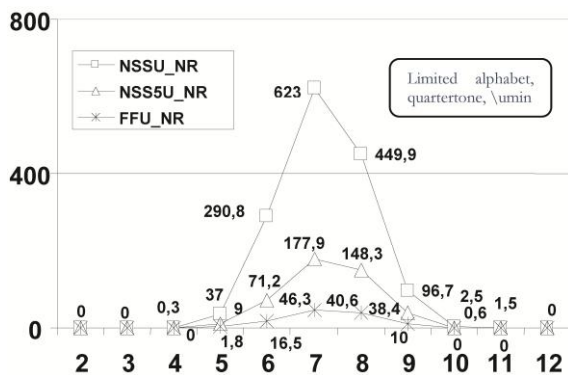

Fig. 50 Same as above, but for the quarter-tone model (alphabet = 2, 3, 4, 5, 6 quarter-tones).<sup>235</sup>

The conjunct semi-tones filter (Fig. 49 and Fig. 50) affects only sub-systems for NI greater than or equal to 5 (compare with Fig. 47: 56 and Fig. 48: 57), with an increased effect for larger values of NI (the last three generations with NI=10, 11, 12 – in the semi-tone model – have zero values as a result).<sup>236</sup>

<sup>234</sup> NSSU\_NR = Number of Sub-Systems in Unitary weighting with the Non-redundant subsystems excluded, NSS5U\_NR = unitary number of redundant sub-systems with a direct fifth, and FFU\_NR with a direct fourth in a fifth. The full alphabet generation in semi-tones shows that optimal values occur for NI=6, except for NSSU\_NR for which the optimal case is NI=5 (pentatonic scales, Appendix E, FHT 3: 74).

<sup>235</sup> The (almost) full alphabet generation in quarter-tones shows that the optimal values occur for NI=7 for NSSU\_NR, and NI=8 for the other variables – see Appendix E, FHT 7: 75.

<sup>236</sup> With the quarter-tone model, sub-systems for NI greater than nine subsist principally because of the possibility to use the three-quarter-tone interval in conjunction with the semi-tone (for example combinations such as 223, 232, and 223): these combinations were excluded for the generations in just fourth, notably with the Conjunct small intervals criterion or through the homogeneity rule.

At this stage of the study, these results are obvious: semi-tones are predominant for larger values of NI, making of it a particularly effective filter. On the far side of the alphabet (Fig. 51<sup>237</sup> and Fig. 52<sup>238</sup>), conjunct large intervals restrict combination possibilities. This makes it impossible to get fourths, for example, as two conjunct one-and-a-half-tones intervals (which form a tri-tone) are already larger than the fourth.

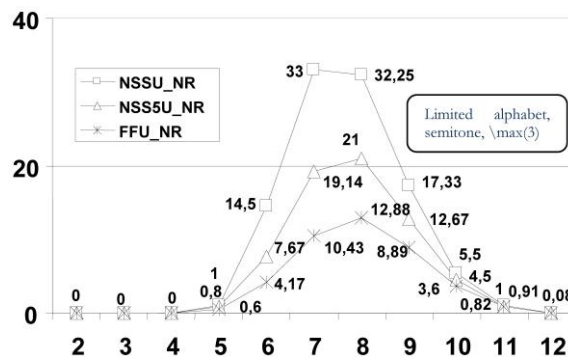

Fig. 51 Unitary non-redundant sub-systems in an octave, restricted alphabet (alphabet = 1, 2, 3), filtering of sub-systems containing two conjunct intervals greater or equal to 3 semi-tones – semi-tone model.<sup>239</sup>

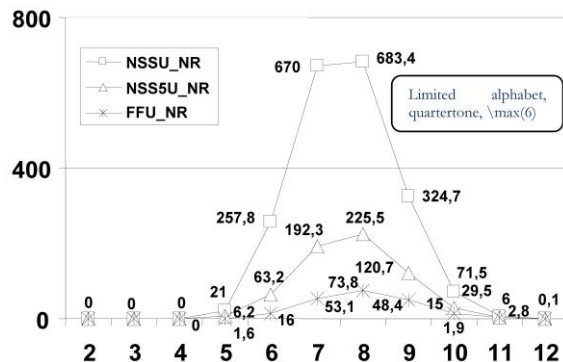

Fig. 52 Same as above, but for the quarter-tone model (alphabet = “2, 3, 4, 5, 6” quarter-tones); filter applies for two conjunct intervals ≥ 6 (quarter-tones).<sup>240</sup>

To exclude such sub-systems with two conjunct intervals equal to, or bigger than, the one-and-a-half-tones interval we must apply the second filter,

<sup>237</sup> All optimal values of the full alphabet generation in semi-tones occur for NI=7 – see Appendix E, FHT 2: 74.

<sup>238</sup> The almost full alphabet generation in quarter-tones shows optimal values for NI=7, except for FFU\_NR (or DQUU\_NR in the appendix) with NI=8 – see Appendix E, FHT 6: 75.

<sup>239</sup> See Appendix E, FHT 2: 74, for the generation with the full alphabet.

<sup>240</sup> The (nearly) full alphabet generation shows optima for NI=7, except for FFU\_NR (or DQUU\_NR in the Appendix) with NI=8 – see Appendix E, FHT 6: 75.

' $\max(3)$ ' or ' $\max(6)$ ' (or exclude sub-systems with two or more conjunct intervals equal to – or greater than – 3 semi-tones or 6 quarter-tones).

The evolution of the curves in Fig. 51 and Fig. 52: 58, if compared with those of Fig. 47: 56 and Fig. 48: 57 is remarkable. Although it excludes conjunctions of large intervals, this filter has no effect for values of NI equal to, or greater than, 9, smaller values of this variable are the most affected with a tendency to favor the NI=8 generation as an optimal value. All systems for NI less than 5 are excluded.

This may be explained by the fact that smaller values of NI facilitate the existence of larger intervals, whenever larger values of NI tend to exclude the latter from sub-systems.<sup>241</sup>

The two filters for conjunct small (semi-tones) or big (larger than the one-and-a-half-tones interval) intervals have, when applied separately, complementary effects: if applied simultaneously, they give most interesting results (Fig. 53 and Fig. 54)<sup>242</sup>.

All optimal values, for both the semi-tone<sup>243</sup> and quarter-tone<sup>244</sup> models, occur for NI=7, with neatly shaped acute angles around the latter, *i.e.*, with rapidly decreasing values as we move away from the optimal NI.

Whenever unfiltered generations of scale element show optimal values for a reduced ambitus of possible numbers of conceptual intervals to the octave (between 6 and 8 conceptual intervals to the octave), and although it is possible that, to start with, scales other than heptatonic may have been used in traditional modal music, further aesthetical (sizes of intervals and their patterns in conjunct forms) and economical (optimal productivity) considerations have stabilized this optimal value at NI=7, confirming thus the predominant role of heptatonism with this music.

<sup>241</sup> Beginning with NI=10, the largest interval is one single one-and-a-half-tones interval – see Appendix D for details about the internal structure of hyper-systems for these generations for the semi-tone model.

<sup>242</sup> This filter excludes sub-systems containing sequences of three or more conjunct semi-tones as well as sub-systems with two conjunct intervals equal to or greater than 3 (semi-tones) or 6 (quarter-tones).

<sup>243</sup> The full alphabet generation shows that optimal values occur for NI=6 – see Appendix E, FHT 4: 75.

<sup>244</sup> The almost full alphabet generation shows that all optimal values occur for NI=7 – see Appendix E, FHT 8: 75.

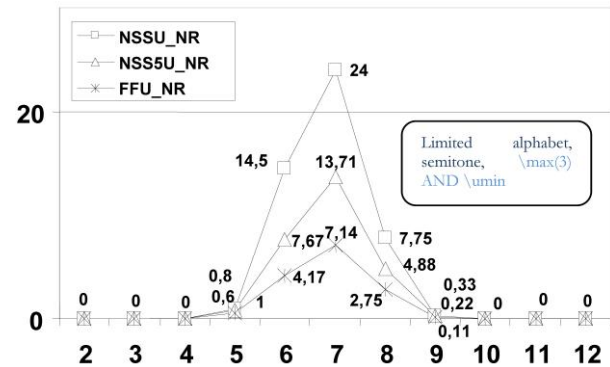

Fig. 53 Unitary non-redundant sub-systems in an octave, restricted alphabet (alphabet = 1, 2, 3) – semi-tone model with intersecting criteria ( $\umin$  OR  $\max(3)$ ) are excluded.<sup>245</sup>

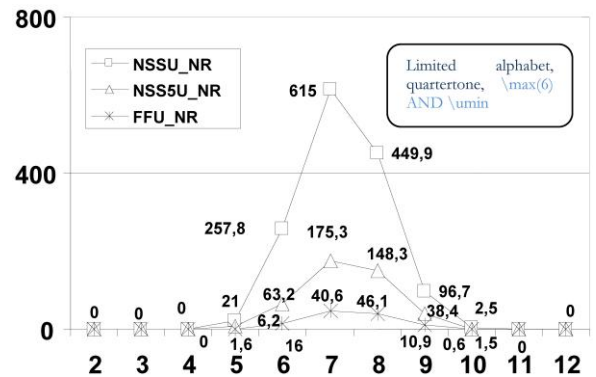

Fig. 54 Same as above, but for the quarter-tone model (alphabet = 2, 3, 4, 5, 6 quarter-tones) – see Appendix E, FHT 8, p. 75, for the full alphabet generation.

## Conclusion of the statistical study of the Scale

Although other models and filters can be applied to the process of interval combination<sup>246</sup> or to particular sub-divisions of modal music<sup>247</sup>, we can draw a simple

<sup>245</sup> For variables: see previous captions (Appendix E, FHT 4: 74, for the full alphabet generation).

<sup>246</sup> Refining filters for the quarter-tone model, for example, in order to verify better adequacy to the heptatonic model, setting the value of the largest interval of the alphabet to the 5 quarter-tones while testing for large conjunct intervals (this would tighten the results around NI=7), or by applying the conjunct small intervals criterion already used for generations within the 'one fourth' containing interval, or still by verifying the conformity of heptatonic sub-systems to the criteria of transitional two-interval semi-tones. This last one keeps only two-interval, and excludes three-interval conjunctions of semi-tones which occur on the transition from a fourth to a fifth, or from a fourth to another fourth, or from one octave to the other – see also the next note.

<sup>247</sup> Other models include the 'LO-GO' generations, with Lower than the Octave, or Greater than the Octave, sums for the sub-systems and models, etc. This can be equivalent to models of the

conclusion from this second part of the article. Heptatonism is, at least partly, the result of an optimization process within interval structure of the containing intervals of the fourth, the fifth and the octave.

## SYNTHESIS

The results of the research shown in Parts I and II tend to prove that traditional choices for containing intervals such as the fourth, the fifth and the octave are not arbitrary decisions but the result of a real need for optimal melodic expression. Within the potentially infinite vertical space of pitches, melodic music seems to have followed a very rational, although intuitive and pragmatic, search for a limitation of combinations for conceptual intervals<sup>248</sup> in order to arrange them as useful paradigms, notwithstanding the unlimited variations of pitches on the boundaries defined by the components of these interval combination paradigms.

These variations have been the subject of endless speculations and mathematical expressions in terms, notably, of string and frequency ratios, which contributed in creating confusion between the two processes of (1) discrimination and (2) identification of intervals. The first process is mainly quantitative, whereas the second is purely qualitative. The first process is related to interval tonometry, while the second relates to the comparison of interval qualities within the frame of a scale or a melodic pattern (or formulae).

These considerations led me to the formulation of new concepts including the differentiation between conceptual (qualitative) and measuring (quantitative) intervals.

Some small intervals within a combination have qualities that distinguish them, in the concept of melodic music, from others. These become stand-alone

entities<sup>249</sup> within larger containing intervals which, in turn, have other intrinsic qualities,<sup>250</sup> making them a perfect receptacle for smaller conceptual intervals<sup>251</sup>. With time, these larger intervals became the fourth, the fifth and the octave, because of the particular relevance of these terms in relation to their interval capacity.

For these numbers of identified classes of smaller conceptual intervals, within the containing larger intervals, the number of useful paradigms is optimal, which means that the number of paradigms ready for immediate, or delayed, composition is at its maximal potential, although the number of identified smaller conceptual intervals is at the minimal which allows for their identification.

In parallel to the relative wealth of expression, the optimal numbers of conceptual intervals (within the larger containing intervals) carry other qualities, especially their ability to produce, when combining smaller conceptual intervals, unique patterns (combinations)<sup>252</sup> within the containing intervals. This non-redundancy among the potential musical paradigms increases the efficiency of the means available for melodic music.

These characteristics make it possible today to formulate two hypotheses on (1) the process of formation of the heptatonic scale, and (2) on the conceptual tools that may be used in the search for the possible origin of this scale.

### *A hypothesis for the formation of the heptatonic scale*

The consonance of the fourth, the fifth and the octave seem to be the common denominator for a large variety and types of music in the world, whilst other intervals have historically been considered as

<sup>249</sup> Un-composed within the containing interval, although measurable with the help of elementary, and measuring, intervals.

<sup>250</sup> Notably acoustic.

<sup>251</sup> These are needed for the composition of the melody.

<sup>252</sup> Except for the quarter-tone model for the fifth containing interval, in which redundancies, although very limited, occur: we have seen that this model fits better the fourth containing interval, with the homogeneity rule leading to unique (non-redundant) tetrachords, which represent all the common tetrachords in Arabian music (the last one including all tetrachords based on semi-tone classes of intervals).

→ octave in, for example, 23, 22, 21, or 25, 26, 27, etc. equal-temperament divisions of the octave) – see [Beyhom, 2003c]. This generation confirms the adequacy of heptatonism in relation with the interval characteristics of modal music, notably in the domain of *maqām*.

<sup>248</sup> Reminder: conjunct seconds in the scale.

dissonant.<sup>253</sup> This position has been supported by arithmetic (Pythagorean tetrad) or acoustic (theory of resonance) considerations. However, acoustic agreement between partial harmonics of different pitches is not the only criterion on which music is based, and although the Pythagorean tetrad is an ingenious means for ratios of the larger consonant<sup>254</sup> intervals, it remains, regardless that small conjunct and fluctuating intervals (“dissonant”) compose the immense majority of the traditional melodic repertoire related to *maqām* music.

Whereas consonance is not a real issue for these small intervals, the most important criteria, when composing melodies with a reduced span such as with most traditional music of heptatonic expression, are aesthetical adequacy and musical expressionism. Now I simply cannot imagine someone starting a musical repertoire, which would at the end of the way lead to the heptatonic meta-system of scales, with the help of interval leaps of combined fourths, fifths and/or octaves in order to arrange a couple of musical sounds together inside a melody.

This could be compared to travelling from one’s own village to the large and far away city, then following another section of the highway in order to go to the village immediately across the valley. It just does not make sense, if there is a road between the two neighboring villages. If not, it is much easier to build the road between the two villages to start with, and then try to go to the large city (the octave)<sup>255</sup> or, before we reach it have a break at a pleasant inn in an average sized town on the way.<sup>256</sup> One can also wander off the road, or take shortcuts to the next break.

This is the heart of interval fluctuations within a scale. Small discrepancies in comparison to the theoretical path assigned between two pitches, due to the morphology of each performer, the organological

particularities of the instrument<sup>257</sup>, it can be the voice or any other instrument, regional or cultural differences, etc. The way in which we walk to the medium sized town may be different,<sup>258</sup> and the particular place within the village, our destination, may be a little bit off limits (one might take a break at a different place within the village),<sup>259</sup> but the destination remains the same.<sup>260</sup>

Combining a few conjunct intervals and going up or down the smaller scale, we may want to change direction and decide to play other pitches corresponding to different intervals, but that would still get us to the limits of the first established path between two pitches. The more possibilities we have in order to switch from one path to another, the more pleasant is our trip whenever we need to travel around a specific region, especially whenever we may find another intermediate middle-sized town in which to set base for further explorations.<sup>261</sup>

This is the essence of modulation, or varying the paths by moving from one established pattern of pitches to another.

While improvising (or exploring) new ways, one must avoid perpetual change of intermediate stops; in order not to burden our fellow travellers we guide after all the explorations already undertaken. The guide may achieve the balance between complexity and expressionism, where the pleasure of reminiscence is mixed with the pleasure of perpetual discovery, and thus avoid excessive strain for the listeners.

This is the essence of *maqām* music as I came to understand it.<sup>262</sup>

On this basis, the formation process of a scale seems to become evident. Starting with a single pitch, neighboring pitches may have been explored in succession until attaining the fourth or the fifth which, because of acoustic qualities and the need to mark a

<sup>253</sup> Because of the possible disagreement between the harmonics which compose, in different proportions, their spectrum, or because of extra-musical reasons, sometimes linked to their numeric properties.

<sup>254</sup> In the acoustic meaning: for the differences between the Pythagorean intervals resulting from the tetrad and acoustic resonance, see [Beyhom, 2016], chapters I and III.

<sup>255</sup> If octave intervals were explored at that time.

<sup>256</sup> The fourth or the fifth, for example.

<sup>257</sup> In our geographical example: the particularities of the landscape.

<sup>258</sup> One might decide to walk (or ride) through different villages.

<sup>259</sup> It is not an exact temperament that is used by the performer.

<sup>260</sup> The ultimate destination being generally the return home (to the final resting note of the *maqām*).

<sup>261</sup> Whenever we stop at a pitch other than the original beginning one, making the former, permanently or (mostly) temporarily, the basis for new developments of the melody.

<sup>262</sup> Mainly in its improvisation form in the 20<sup>th</sup> century.

pause, or start a further stage, became the new turning point of the melody. From there on, our original performer may have chosen to go back to the starting pitch, and even beyond for a few notes and then back to it, then explore the same path, or change it for the sake of varying the original melodic pattern.<sup>263</sup>

Therefore, in a reduced span of one smaller containing interval and with occasional overtaking of its boundaries, the performer can have obtained an ensemble of key-patterns of interval sizes, clearly distinguishable for the ear of his listeners which became, in time, identified qualities of intervals within this first containing interval, the fourth (or the fifth – I explore this possibility in the next section).

At this point, the musician could explore two ways of enriching his music: he may choose to slightly change the intervals he uses to enrich the hearing experience,<sup>264</sup> depending however on the listeners awareness of such small variations:<sup>265</sup> further differentiation of the small identified intervals may well begin to seem too esoteric for the listeners, as the discrepancies will seem too small (when they are smaller than a third of a tone, or a quarter-tone) to be clearly distinguished, and identified; the performer has reached a state of balance between his musical expressionism and the listeners ability to follow his more or less subtle modifications of the melody.<sup>266</sup>

This is the point when spatial extension, in either of both directions must have become indispensable in order to pursue melodic composition (it may be spontaneous or delayed, as stated above), notwithstanding the other variations he already have used for the limited melodic pattern(s) he has already used,<sup>267</sup> which can also be used, in the same or in a parallel way, with the extended pattern(s). From there we have many possibilities, all of them, considering

the original process of composing the fourth, leading to the same result: the heptatonic scale.

#### FROM THE FOURTH TO THE OCTAVE

Possible ways of reaching the octave (or avoiding it as some *maqām do*)<sup>268</sup> are:

1. The exploration of the large containing octave interval in a linear manner, that is by testing conjunct intervals in succession or in alternation (in the latter case with intermediate pitches being part of the resulting scale).
2. The addition of smaller containing intervals to one another (for example two fourths and a one-tone interval, or a fourth and a fifth) and use each as an almost independent entity.
3. The expansion of a relatively small containing interval (a fourth or a fifth) by:
  - searching for successive or alternate notes inside the upper (or lower) fifth or fourth, the boundaries of either of the latter being the new starting point for this exploration,
  - choosing any intermediate pitch in the original fourth or fifth (or any other initial configuration of conjunct intervals) and applying any of the three processes explained above,
  - combining any of the above.

With all these processes, the containing intervals must not be considered as imposing strictly delimited boundaries for the scale, but as indicating sizes of intervals justified by their acoustic characteristics. In other words, the three consonant containing intervals within the octave do not *bind* the performer (and the music), but *guide* him in the creative process of music composition.<sup>269</sup>

<sup>268</sup> For example *maqām Šabā* in Arabian music, the scale of which may be expressed as  $d e f g^b a' b^{b'} c' d^{b'}$ ; the upper octave is generally different from the lower one, and occurrences for  $d'$  are exceptional (commonly, the transition from the first to the second octave uses  $d^{b'} e' f'$  to complete the ascending *hijāz* tetrachord beginning with  $c'$ ). Please note that that about 20 other Arabian modes have similar characteristics as *maqām Šabā* – see [Beyhom, 2016], Chapter III.

<sup>269</sup> This explains why, as an aesthetic choice, performers who are well aware of the importance of the three consonant containing intervals may deliberately ignore them in order to obtain a different combination (such as avoiding the fourth and the octave in *maqām Šabā* – see previous footnote).

<sup>263</sup> This is defined as “generalized pitch heterophony” in [Beyhom, 2016, p. 76].

<sup>264</sup> Which I define as “localized pitch heterophony” in [Beyhom, 2016, p. 76].

<sup>265</sup> And on the performer’s ability to memorize them, as well as to conceptualize (and possibly, eventually, explain) and reproduce them.

<sup>266</sup> This state of balance is reached by the performer depending on his ability to (1) identify these slightly different intervals, and/or (2) reproduce them with his voice or his instrument.

<sup>267</sup> i.e. localized and generalized heterophony.

Whatever processes the performer chooses he will reach the same conclusion. The optimal repartition for intervals within the boundaries of the three containing intervals is three to a fourth, four to a fifth, and seven to an octave. The performer may decide to avoid the aesthetics implied in the process,<sup>270</sup> but optimal expressivity is reached with these numbers and remains an unavoidable conclusion.

#### ON BOTH SIDES OF THE OCTAVE

Now that we have reached the big city and that the intermediate stops are already explored, now that one has even determined alternative routes avoiding the heart of the city or the passage into smaller, intermediate towns, the performer may decide to conclude his composition or he may wish to undertake further explorations of the space beyond the boundaries. He could decide for example to jump (take a shortcut) from one pitch to another one a fourth or a fifth apart, and then come back, or go further, in order to explore the intermediate, or upper or lower, pitches until he and his listeners are satisfied with the new voyage where he guided them.

Eventually, with the increasing number of musicians in one location, performers came together to play alternative forms, each of them exploring parallel or separate ways of getting from one point to another of the containing interval, each of them with his own morphology, instrument(s), artistic taste, and origins. Each of them would listen to other musicians' performance and support or be inspired by it, or would be supported by those and inspire them himself.

This process may have strengthened the predominance of what we call today heterophony, in the large sense of the word: it may well be that, whenever this liberty of exploration vanished and became bounded by more or less strict patterns of progression of simultaneous musical parts, or whenever the octave (or largest) containing interval became prominent in a particular musical culture,<sup>271</sup>

<sup>270</sup> For example: (1) use relatively large intervals within a containing interval, (2) avoid the consonances of fourth, fifth or the octave, (3) use a certain number of conjunct semi-tones in a row, etc.

<sup>271</sup> Or whenever this simultaneous emission of more or less parallel melodic patterns was part of the local culture – the hypothesis developed in this paragraph does not necessarily apply

another form of music came to light, the one which is today called polyphony.

#### CLUES ABOUT THE POSSIBLE ORIGINS OF THE HEPTATONIC SCALE

If culture differs from one civilization to another, some characteristics are common almost to all. Heptatonic scales, in the historical realm of modal music, are one of these common denominators. It seems that the number of seven conceptual intervals to the octave is the result of musically shared aesthetical criteria over a large region and for a long historical period. These criteria, which may probably be further enriched, are:

- the consistency of bi-interval combinations (the use of middle-sized conceptual intervals) within a scale, *i.e.* avoiding:
  - successions of very small (like the semi-tones) or large (like the one-tone-and-a-half) elements (intervals),
  - conjunctions of very small elements (like the semi-tone and the three-quarter-tone intervals) and,
  - successions of large elements within the fourth (like adjacent zalzalian augmented seconds or more, or alternating tones and bigger intervals in conjunction, etc.,
- the use of an optimal step, also a smallest scale interval, for interval differentiation and identification,
- the use of a limited alphabet of intervals of the second,
- the acoustic guidance of the main three large containing intervals (the fourth, the fifth, and the octave).

Other numbers of conceptual intervals may have been used for the octave, for example when these criteria did not apply very strictly, or when the need

→ to this type of music as for example the 'Are 'Are music of the Solomon Islands, but may apply to improvised polyphonic music, in which the freedom of expression with the single performer is replaced by the freedom of vertical improvisation within a party of musicians. The hypothesis is that, even in the latter case, a preliminary process of scale calibration, as the one explained in the text above, is at the origin of heptatonic scales (if used in that particular music).

for particular combinations arose (for example on aesthetic or social grounds).

Whenever a specific culture decided to choose a lesser number of intervals in a scale, aesthetic criteria may have varied. In pentatonic music, for example, such a limitation as the three-semi-tones interval being the greatest conjunct interval in the scale, may have been set at a higher value. This makes it more difficult to create smaller containing intervals, especially the fourth, but leaves the larger containing intervals (like the fifth and the octave) role as acoustic guides for the performer (about) unchanged.

Choosing a number of intervals larger than seven, further possibilities appear. However, they are simple extensions of the optimized octave scales (containing seven conjunct conceptual intervals), or possible loop lines around some of the aesthetic criteria listed above (for example the inclusion of conjunct semi-tones).<sup>272</sup>

If a culture decides that the acoustic characteristics of containing intervals are the leading criterion, the choice of the fourth may have led to the use of the intermediate zalzalian intervals composing it, in order to maximize its possibilities, whenever the choice of the fifth maximized the use of semi-tones, which favored in its turn the appearance of tense diatonism (based on successions of tones and semi-tones).

The choice of the octave as the main acoustic criterion may, on the other side, have precipitated a process of equivalence between intervals with a difference of an octave (for example between a fourth and an octave-and-a-fourth), and the use of parallel lines in polyphonic music.

All of these criteria have different powers according to the culture in which they appear. The balance between them has led to different subdivisions of one main form of music, called heptatonic modality.

Later on, and in order to arrange musical systems of intervals within a coherent music theory, different civilizations have sometimes chosen different formulations, some to keep a firm connection with music performance, and some others based on a mathematical, seemingly more elegant basis, having some connections with musical practice or acoustic characteristics of musical intervals.

With time theory became an entity of its own and was developed by scholars for the sake of the beauty of mathematical constructions which were confused by their promoters, and later by their followers, being a generative theory, and whenever any musical theory should first rely on practice.

The mathematical expression of intervals through string ratios or through other, very small, quantifying intervals gave theoreticians the illusion that intervals do have exact sizes in performance, even if modal practice refutes this assertion.

The map became the territory, whenever it should have been, at most, a conventional sketch of the territory, or a more or less precise guide within the infinite possibilities of pitches within a containing interval. In order to remain a guide, and not become a rigid yoke to musical expressivity, theoretical expressions of scales should, first of all, differentiate between quantitative and qualitative intervals, and between conceptual, quantifying and elementary intervals, in order to stay, where possible, close to music performance and far from interval quantization.

As an overall conclusion to this study, this research gives a new, plausible explanation for heptatonism as a privileged receptacle for modal scales. Some criteria underlined in the article, like the homogeneity rule, the insistence on the fourth or fifth, or any other indication of a calibration process of the scale, may give complementary information in the search for its origin.

<sup>272</sup> Octatonic or enneatonic scales found in some literature may also be the result of the inclusion of modulation variants for a scale, or for part of it, at least in music theory.

APPENDIX A: SCALE ELEMENTS IN EIGHTHS OF THE TONE, WITHIN THE CONTAINING INTERVAL OF THE FOURTH (= 20 EIGHTHS OF THE TONE)

Remarks:

- ni: number of intervals within the scale elements
- >: large intervals
- \*: double semi-tone criterion
- **Bold**: commonly used genera in Arabian music
- *Italics* and ~~stricken~~: redundant combinations
- Underlined: semi-tone equivalent combinations

**ni = 2**

4 16<sup>></sup>, 16 4<sup>></sup>

5 15<sup>></sup>, 15 5<sup>></sup>

6 14<sup>></sup>, 14 6<sup>></sup>

7 13<sup>></sup>, 13 7<sup>></sup>

8 12, 12 8

9 11, 11 9

10 10, ~~10 10~~

**ni = 3**

4 4 12<sup>\*</sup>, **4 12 4**, 12 4 4<sup>\*</sup>

4 5 11, 5 11 4, 11 4 5

4 11 5, 11 5 4, 5 4 11

4 6 10, **6 10 4**, 10 4 6

**4 10 6**, 10 6 4, 6 4 10

4 7 9, 7 9 4, 9 4 7

4 9 7, 9 7 4, 7 4 9

**4 8 8**, **8 8 4**, **8 4 8**

5 5 10, 5 10 5, 10 5 5

5 6 9, 6 9 5, 9 5 6

5 9 6, 9 6 5, 6 5 9

5 7 8, 7 8 5, 8 5 7

5 8 7, 8 7 5, 7 5 8

**6 6 8**, **6 8 6**, **8 6 6**

6 7 7, 7 7 6, 7 6 7

**ni = 4**

4 4 4 8<sup>\*</sup>, 4 4 8 4<sup>\*</sup>, 4 8 4 4<sup>\*</sup>, 8 4 4 4<sup>\*</sup>

4 4 5 7<sup>\*</sup>, 4 5 7 4, 5 7 4 4<sup>\*</sup>, 7 4 4 5<sup>\*</sup>

4 4 7 5<sup>\*</sup>, 4 7 5 4, 7 5 4 4<sup>\*</sup>, 5 4 4 7<sup>\*</sup>

4 5 4 7, 5 4 7 4, 4 7 4 5, 7 4 5 4

4 4 6 6<sup>\*</sup>, 4 6 6 4, 6 6 4 4<sup>\*</sup>, 6 4 4 6<sup>\*</sup>

4 6 4 6, 6 4 6 4, ~~4 6 4 6~~, ~~6 4 6 4~~

4 5 5 6, 5 5 6 4, 5 6 4 5, 6 4 5 5

4 5 6 5, 5 6 5 4, 6 5 4 5, 5 4 5 6

4 6 5 5, 6 5 5 4, 5 5 4 6, 5 4 6 5

5 5 5 5, ~~5 5 5 5~~, ~~5 5 5 5~~, ~~5 5 5 5~~

**ni = 5**

4 4 4 4 4<sup>\*</sup>, 4 4 4 4 4<sup>\*</sup>, 4 4 4 4 4<sup>\*</sup>, 4 4 4 4 4<sup>\*</sup>, 4 4 4 4 4<sup>\*</sup>

\*  
\* \*

APPENDIX B: TABLES OF THE COMBINATION PROCESS FOR A JUST FIFTH, WITH NI=4 (QUARTER-TONE MODEL) AND A REDUCED ALPHABET OF INTERVALS (FROM THE SEMI-TONE TO THE ONE-AND-A-HALF-TONES INTERVAL)

Remarks:

- ns: number of systems
- \*: conjunct semi-tones
- §: scale elements that contain ‘conjunct big intervals’, i.e., at least two conjunct intervals that are bigger or equal to the one-tone interval, and among which one is at least bigger than the tone
- **Bold font**: main pentachords in use in Arabian music
- <sup>c</sup>: scale elements to which a semi-tone must be added in order to complete the *hijāz* tetrachord (‘262’)
- *Italic font*: pentachords that, to my knowledge, are not in use in Arabian music
- *Italic font* and ~~stricker~~: redundant pentachords
- underlined with gray background: semi-tone-compatible pentachords

1<sup>st</sup> column: number of the hyper-system, intervallic composition of the hyper-system, and number of systems (‘ns’) related to it

2<sup>nd</sup> column: number of the hyper-system (‘No. hyp.’)

3<sup>rd</sup> column: number of the system (‘No. sys.’)

4<sup>th</sup> column: number of the sub-system or ‘pentachord’ (‘No. pent.’)

5<sup>th</sup> column: intervals of the sub-system in integer multiples of the quarter-tone (‘value’)

Hyper-system	No. hyp.	No. sys.	No. pent.	value
No. 1 2 2 4 6 ns: 3	1	1	1	<u>2246</u> <sup>§§</sup>
	1	1	2	<u>2462</u> <sup>§</sup>
	1	1	3	<u>4622</u> <sup>§§</sup>
	1	1	4	<u>6224</u> <sup>*</sup>
	1	2	1	<u>2426</u> <sup>c</sup>
	1	2	2	<b>4262</b>
	1	2	3	<b>2624</b>
	1	2	4	<u>6242</u>
	1	3	1	<u>2642</u>
	1	3	2	<u>6422</u> <sup>§§</sup>
	1	3	3	<u>4226</u> <sup>*</sup>
	1	3	4	<u>2264</u> <sup>§§</sup>

Hyper-system	No. hyp.	No. sys.	No. pent.	value
No. 2 2 2 5 5 ns: 2	2	1	1	2525
	2	1	2	5252
	2	1	3	<del>2525</del>
	2	1	4	<del>5252</del>
	2	2	1	2552 <sup>§</sup>
	2	2	2	5522 <sup>§§</sup>
	2	2	3	5225 <sup>§§</sup>
	2	2	4	2255 <sup>§§</sup>

Hyper-system	No. hyp.	No. sys.	No. pent.	value
No. 3 2 3 3 6 ns: 3	3	1	1	2336
	3	1	2	3362
	3	1	3	3623
	3	1	4	6233
	3	2	1	2363
	3	2	2	3632
	3	2	3	6323
	3	2	4	3236
	3	3	1	2633
	3	3	2	6332
	3	3	3	<b>3326</b> <sup>c</sup>
	3	3	4	3263

Hyper-system	No. hyp.	No. sys.	No. pent.	value
No. 4 2 3 4 5 ns: 6	4	1	1	2 3 4 5 <sup>s</sup>
	4	1	2	3 4 5 2 <sup>s</sup>
	4	1	3	4 5 2 3 <sup>s</sup>
	4	1	4	5 2 3 4
	4	2	1	2 3 5 4 <sup>s</sup>
	4	2	2	3 5 4 2 <sup>s</sup>
	4	2	3	5 4 2 3 <sup>s</sup>
	4	2	4	4 2 3 5
	4	3	1	2 4 3 5
	4	3	2	4 3 5 2
	4	3	3	3 5 2 4
	4	3	4	5 2 4 3
	4	4	1	2 4 5 3 <sup>s</sup>
	4	4	2	4 5 3 2 <sup>s</sup>
	4	4	3	5 3 2 4
	4	4	4	3 2 4 5 <sup>s</sup>
	4	5	1	2 5 3 4
	4	5	2	5 3 4 2
	4	5	3	3 4 2 5
	4	5	4	4 2 5 3
4	6	1	2 5 4 3 <sup>s</sup>	
4	6	2	5 4 3 2 <sup>s</sup>	
4	6	3	4 3 2 5	
4	6	4	3 2 5 4 <sup>s</sup>	

Hyper-system	No. hyp.	No. sys.	No. pent.	value
No. 7 3 3 4 4 ns: 2	7	1	1	3 3 4 4
	7	1	2	3 4 4 3
	7	1	3	4 4 3 3
	7	1	4	4 3 3 4
	7	2	1	3 4 3 4
	7	2	2	4 3 4 3
	7	2	3	3 4 3 4
	7	2	4	4 3 4 3

\* \* \*

\_\_\_Interval '2' occurs 80 times (included 4 times in redundant sub-systems)

\_\_\_Interval '3' occurs 72 times (included 4 times in redundant sub-systems)

\_\_\_Interval '4' occurs 60 times (included 4 times in redundant sub-systems)

\_\_\_Interval '5' occurs 44 times (included 4 times in redundant sub-systems)

\_\_\_Interval '6' occurs 24 times (not in redundant sub-systems)

Note: the total number of pentachords is 72, of which 4 are redundant.

Hyper-system	No. hyp.	No. sys.	No. pent.	value
No. 5 2 4 4 4 ns: 1	5	1	1	2 4 4 4
	5	1	2	4 4 4 2
	5	1	3	4 4 2 4
	5	1	4	4 2 4 4

\* \* \*

Hyper-system	No. hyp.	No. sys.	No. pent.	value
No. 6 3 3 3 5 ns: 1	6	1	1	3 3 3 5
	6	1	2	3 3 5 3
	6	1	3	3 5 3 3
	6	1	4	5 3 3 3

### APPENDIX C: COMPLETE RESULTS OF THE SEMI-TONE GENERATION WITHIN A CONTAINING INTERVAL OF FIFTH

(The results were obtained through the computer program modes V. 5.2 developed by the author)

Additional remarks:

- “ni”: number of conceptual intervals per system
- “non”=“no”, “oui”=“yes” as an answer for the detection of various below listed criteria
- “5tes”: test on the presence of a just fifth beginning with the first interval
- “4tes”: test on the presence of a just fourth beginning with the first interval
- D\_QQ: test on the presence of a just fourth AND a just fifth beginning with the first interval (like FF)
- UM: ‘ultra-min’ criterion for the detection of suites of three (or more) semi-tones (‘1’) in a row
- min: ‘min’ criterion for the detection of suites of two semi-tones (‘1’) in a row
- max: ‘max’ criterion for the detection of suites of two (or more) intervals equal or superior to

‘it\_maxc’ (the value of the latter is set for this generation to ‘3’ semi-tones)

- Additional remark for the last three criteria: these are equally effective for the detection of intervals in a double-fifth (the checked system is the double-fifth composed of two identical sub-systems); for the results shown in the article (Fig. 37), the results were subsequently adapted for a single fifth.
- n° hyp.: rank of the hyper-system for the current ni
- n° sys.: rank of the system for the current hyper-system
- n° s-sys.: rank of the sub-system for the current system
- imin: smallest interval used for the generation
- imax: largest interval used for the generation
- redundant sub-systems for ni=7 are in **bold**
- “occurrences de l’intervalle “\*”: number of times interval “\*” is detected in the sub-systems for the current ni

Base de données sous-systèmes: CALCUL N° 1 ni = 7 imin = 1 imax = 7 it\_maxc = 3

hyper n° 1 ; val.: 1 6  
 sys.: 1 ; 5tes: 2 ; 4tes 0 ; D\_QQ 0

n° hyp.	n° sys.	n° s_sys.	valeur	5tes	4tes	D_QQ	UM	min	max
1	1	1	1 6	oui	non	non	non	non	non
1	1	2	6 1	oui	non	non	non	non	non

hyper n° 2 ; val.: 2 5  
 sys.: 1 ; 5tes: 2 ; 4tes 1 ; D\_QQ 1

n° hyp.	n° sys.	n° s_sys.	valeur	5tes	4tes	D_QQ	UM	min	max
2	1	1	2 5	oui	non	non	non	non	non
2	1	2	5 2	oui	oui	oui	non	non	non

hyper n° 3 ; val.: 3 4  
 sys.: 1 ; 5tes: 2 ; 4tes 0 ; D\_QQ 0

n° hyp.	n° sys.	n° s_sys.	valeur	5tes	4tes	D_QQ	UM	min	max
3	1	1	3 4	oui	non	non	non	non	oui
3	1	2	4 3	oui	non	non	non	non	oui

occurrences de l'intervalle: 1 = 2  
 occurrences de l'intervalle: 2 = 2  
 occurrences de l'intervalle: 3 = 2  
 occurrences de l'intervalle: 4 = 2  
 occurrences de l'intervalle: 5 = 2  
 occurrences de l'intervalle: 6 = 2

Annotations in the image:

- Rank of the current hyper-system (points to 'hyper n°' and 'D\_QQ')
- Number of systems within the current hyper-system (points to 'n° hyp.' and 'n° sys.') and 'Intervals of the hyper-system' (points to 'val.:')
- Number of sub-systems containing a just fifth beginning with the first interval (points to '5tes')
- Number of sub-systems containing a just fourth beginning with the first interval (points to '4tes')
- Number of sub-systems containing a just fourth and a just fifth beginning with the first interval (points to 'D\_QQ')

New  $n_i = 3$

Base de données sous-systèmes: CALCUL N° 2  $n_i = 3$   $i_{min} = 1$   $i_{max} = 7$   $i_{t\_maxc} = 3$

hyper n° 1 ; val.: 1 1 5  
sys.: 1 ; 5tes: 3 ; 4tes 1 ; D\_QQ 1

n° hyp.	n° sys.	n° s_sys.	valeur	5tes	4tes	D_QQ	UM	min	max
1	1	1	1 1 5	oui	non	non	non	oui	non
1	1	2	1 5 1	oui	non	non	non	oui	non
1	1	3	5 1 1	oui	oui	oui	non	oui	non

hyper n° 2 ; val.: 1 2 4  
sys.: 2 ; 5tes: 6 ; 4tes 2 ; D\_QQ 2

n° hyp.	n° sys.	n° s_sys.	valeur	5tes	4tes	D_QQ	UM	min	max
2	1	1	1 2 4	oui	non	non	non	non	non
2	1	2	2 4 1	oui	non	non	non	non	non
2	1	3	4 1 2	oui	oui	oui	non	non	non

2 2 1 4 2  
2 2 2 4 2 1  
2 2 3 2 1 4

2	2	1	1 4 2	oui	oui	oui	non	non	non
2	2	2	4 2 1	oui	non	non	non	non	non
2	2	3	2 1 4	oui	non	non	non	non	non

hyper n° 3 ; val.: 1 3 3  
sys.: 1 ; 5tes: 3 ; 4tes 0 ; D\_QQ 0

n° hyp.	n° sys.	n° s_sys.	valeur	5tes	4tes	D_QQ	UM	min	max
3	1	1	1 3 3	oui	non	non	non	non	oui
3	1	2	3 3 1	oui	non	non	non	non	oui
3	1	3	3 1 3	oui	non	non	non	non	oui

hyper n° 4 ; val.: 2 2 3  
sys.: 1 ; 5tes: 3 ; 4tes 2 ; D\_QQ 2

n° hyp.	n° sys.	n° s_sys.	valeur	5tes	4tes	D_QQ	UM	min	max
4	1	1	2 2 3	oui	non	non	non	non	non
4	1	2	2 3 2	oui	oui	oui	non	non	non
4	1	3	3 2 2	oui	oui	oui	non	non	non

— occurrences de l`intervalle: 1 = 15  
— occurrences de l`intervalle: 2 = 12  
— occurrences de l`intervalle: 3 = 9  
— occurrences de l`intervalle: 4 = 6  
— occurrences de l`intervalle: 5 = 3

New ni=4

Base de données sous-systèmes: CALCUL N° 3 ni = 4 imin = 1 imax = 7 it\_maxc = 3

hyper n° 1 ; val.: 1 1 1 4  
 sys.: 1 ; 5tes: 4 ; 4tes 2 ; D\_QQ 2

n° hyp.	n° sys.	n° s_sys.	valeur	5tes	4tes	D_QQ	UM	min	max
1	1	1	1 1 1 4	oui	non	non	oui	oui	non
1	1	2	1 1 4 1	oui	non	non	oui	oui	non
1	1	3	1 4 1 1	oui	oui	oui	oui	oui	non
1	1	4	4 1 1 1	oui	oui	oui	oui	oui	non

hyper n° 2 ; val.: 1 1 2 3  
 sys.: 3 ; 5tes: 12 ; 4tes 5 ; D\_QQ 5

n° hyp.	n° sys.	n° s_sys.	valeur	5tes	4tes	D_QQ	UM	min	max
2	1	1	1 1 2 3	oui	non	non	non	oui	non
2	1	2	1 2 3 1	oui	non	non	non	oui	non
2	1	3	2 3 1 1	oui	oui	oui	non	oui	non
2	1	4	3 1 1 2	oui	oui	oui	non	oui	non

2	2	1	1 1 3 2	oui	oui	oui	non	oui	non
2	2	2	1 3 2 1	oui	non	non	non	oui	non
2	2	3	3 2 1 1	oui	oui	oui	non	oui	non
2	2	4	2 1 1 3	oui	non	non	non	oui	non

2	3	1	1 2 1 3	oui	non	non	non	non	non
2	3	2	2 1 3 1	oui	non	non	non	non	non
2	3	3	1 3 1 2	oui	oui	oui	non	non	non
2	3	4	3 1 2 1	oui	non	non	non	non	non

hyper n° 3 ; val.: 1 2 2 2  
 sys.: 1 ; 5tes: 4 ; 4tes 3 ; D\_QQ 3

n° hyp.	n° sys.	n° s_sys.	valeur	5tes	4tes	D_QQ	UM	min	max
3	1	1	1 2 2 2	oui	oui	oui	non	non	non
3	1	2	2 2 2 1	oui	non	non	non	non	non
3	1	3	2 2 1 2	oui	oui	oui	non	non	non
3	1	4	2 1 2 2	oui	oui	oui	non	non	non

\_\_\_\_\_occurrences de l`intervalle: 1 = 40  
 \_\_\_\_\_occurrences de l`intervalle: 2 = 24  
 \_\_\_\_\_occurrences de l`intervalle: 3 = 12  
 \_\_\_\_\_occurrences de l`intervalle: 4 = 4

\*  
 \*\*

## APPENDIX D: HYPER-SYSTEMS OF THE SEMI-TONE OCTAVE COMPLETE ALPHABET GENERATION

### Remarks:

- “ni”: number of conceptual intervals per system
- “hyper”: hyper-system
- “Sys.”: number of systems for the current hyper-system
- NSS5, NSS4: number of systems with a just fifth, or a just fourth, beginning with the first interval
- “Value”: explicit intervallic suite representing the hyper-system
- NDFP: number of systems that pass the test on the presence of a just fourth and a just fifth beginning with the first interval
- *Italic*: systems or hyper-systems containing redundant sub-systems
- ***Bold and italic***: completely redundant hyper-systems

On grey or golden background: hyper-systems that use the limited alphabet ‘1, 2, 3’

Lastly: hyper-systems that generate redundant sub-systems have a structure in which there is room for repeated patterns of intervals within the

complete scale, as for example in hyper-system ‘1 1 1 1 4 4’ (for  $ni = 6$ ); in this configuration of interval capacity, we may obtain the scheme ‘1 1’ ‘1 1’ ‘4 4’ (three pairs of identical intervals in all): this means that there exists at least one possibility of combining these intervals, in patterns of three conjunct intervals, in a system configuration which generates redundant sub-systems. One such system for the latter case is “1 1 4 1 1 4” in which the tri-intervallic combination “1 1 4” is repeated twice, and generates three redundant sub-systems (beginning with the fourth de-ranking process – the first one corresponding to the initial configuration) as shown below:

- 1<sup>st</sup> sub-system: 1 1 4 1 1 4
- 2<sup>nd</sup> sub-system: 1 4 1 1 4 1
- 3<sup>rd</sup> sub-system: 4 1 1 4 1 1
- 4<sup>th</sup> sub-system: 1 1 4 1 1 4 (identical to No. 1)
- 5<sup>th</sup> sub-system: 1 4 1 1 4 1 (id. to No. 2)
- 6<sup>th</sup> sub-system: 4 1 1 4 1 1 (id. to No. 3)

### ni = 2

hyper no. 1	value: 1 1 1	NS: 1	NSS5: 0	NSS4: 0	NDFP: 0
hyper no. 2	value: 2 1 0	NS: 1	NSS5: 0	NSS4: 0	NDFP: 0
hyper no. 3	value: 3 9	NS: 1	NSS5: 0	NSS4: 0	NDFP: 0
hyper no. 4	value: 4 8	NS: 1	NSS5: 0	NSS4: 0	NDFP: 0
hyper no. 5	value: 5 7	NS: 1	NSS5: 1	NSS4: 1	NDFP: 0
<b>hyper no. 6</b>	<b>value: 6 6</b>	<b>NS: 1</b>	<b>NSS5: 0</b>	<b>NSS4: 0</b>	<b>NDFP: 0</b>

### ni = 3

hyper no. 1	value: 1 1 1 0	NS: 1	NSS5: 0	NSS4: 0	NDFP: 0
hyper no. 2	value: 1 2 9	NS: 2	NSS5: 0	NSS4: 0	NDFP: 0
hyper no. 3	value: 1 3 8	NS: 2	NSS5: 0	NSS4: 0	NDFP: 0
hyper no. 4	value: 1 4 7	NS: 2	NSS5: 2	NSS4: 2	NDFP: 0
hyper no. 5	value: 1 5 6	NS: 2	NSS5: 2	NSS4: 2	NDFP: 0
hyper no. 6	value: 2 2 8	NS: 1	NSS5: 0	NSS4: 0	NDFP: 0
hyper no. 7	value: 2 3 7	NS: 2	NSS5: 2	NSS4: 2	NDFP: 0
hyper no. 8	value: 2 4 6	NS: 2	NSS5: 0	NSS4: 0	NDFP: 0
hyper no. 9	value: 2 5 5	NS: 1	NSS5: 2	NSS4: 2	NDFP: 1
hyper no. 10	value: 3 3 6	NS: 1	NSS5: 0	NSS4: 0	NDFP: 0
hyper no. 11	value: 3 4 5	NS: 2	NSS5: 2	NSS4: 2	NDFP: 0
<b>hyper no. 12</b>	<b>value: 4 4 4</b>	<b>NS: 1</b>	<b>NSS5: 0</b>	<b>NSS4: 0</b>	<b>NDFP: 0</b>

**ni = 4**

hyper no. 1	value: 1119	NS: 1	NSS5: 0	NSS4: 0	NDFF: 0
hyper no. 2	value: 1128	NS: 3	NSS5: 0	NSS4: 0	NDFF: 0
hyper no. 3	value: 1137	NS: 3	NSS5: 3	NSS4: 3	NDFF: 0
hyper no. 4	value: 1146	NS: 3	NSS5: 4	NSS4: 4	NDFF: 0
<i>hyper no. 5</i>	<i>value: 1155</i>	<i>NS: 2</i>	<i>NSS5: 4</i>	<i>NSS4: 4</i>	<i>NDFF: 1</i>
hyper no. 6	value: 1227	NS: 3	NSS5: 3	NSS4: 3	NDFF: 0
hyper no. 7	value: 1236	NS: 6	NSS5: 4	NSS4: 4	NDFF: 0
hyper no. 8	value: 1245	NS: 6	NSS5: 10	NSS4: 10	NDFF: 4
hyper no. 9	value: 1335	NS: 3	NSS5: 3	NSS4: 3	NDFF: 0
hyper no. 10	value: 1344	NS: 3	NSS5: 4	NSS4: 4	NDFF: 0
hyper no. 11	value: 2226	NS: 1	NSS5: 0	NSS4: 0	NDFF: 0
hyper no. 12	value: 2235	NS: 3	NSS5: 7	NSS4: 7	NDFF: 4
<i>hyper no. 13</i>	<i>value: 2244</i>	<i>NS: 2</i>	<i>NSS5: 0</i>	<i>NSS4: 0</i>	<i>NDFF: 0</i>
hyper no. 14	value: 2334	NS: 3	NSS5: 4	NSS4: 4	NDFF: 0
<b>hyper no. 15</b>	<b>value: 3333</b>	<b>NS: 1</b>	<b>NSS5: 0</b>	<b>NSS4: 0</b>	<b>NDFF: 0</b>

**ni = 5**

hyper no. 1	value: 11118	NS: 1	NSS5: 0	NSS4: 0	NDFF: 0
hyper no. 2	value: 11127	NS: 4	NSS5: 4	NSS4: 4	NDFF: 0
hyper no. 3	value: 11136	NS: 4	NSS5: 6	NSS4: 6	NDFF: 0
hyper no. 4	value: 11145	NS: 4	NSS5: 10	NSS4: 10	NDFF: 4
hyper no. 5	value: 11226	NS: 6	NSS5: 6	NSS4: 6	NDFF: 0
hyper no. 6	value: 11235	NS: 12	NSS5: 24	NSS4: 24	NDFF: 10
hyper no. 7	value: 11244	NS: 6	NSS5: 12	NSS4: 12	NDFF: 4
hyper no. 8	value: 11334	NS: 6	NSS5: 12	NSS4: 12	NDFF: 0
hyper no. 9	value: 12225	NS: 4	NSS5: 10	NSS4: 10	NDFF: 6
hyper no. 10	value: 12234	NS: 12	NSS5: 24	NSS4: 24	NDFF: 8
hyper no. 11	value: 12333	NS: 4	NSS5: 6	NSS4: 6	NDFF: 0
hyper no. 12	value: 22224	NS: 1	NSS5: 0	NSS4: 0	NDFF: 0
hyper no. 13	value: 22233	NS: 2	NSS5: 6	NSS4: 6	NDFF: 4

**ni = 6**

hyper no. 1	value: 111117	NS: 1	NSS5: 1	NSS4: 1	NDFF: 0
hyper no. 2	value: 111126	NS: 5	NSS5: 8	NSS4: 8	NDFF: 0
hyper no. 3	value: 111135	NS: 5	NSS5: 14	NSS4: 14	NDFF: 6
<i>hyper no. 4</i>	<i>value: 111144</i>	<i>NS: 3</i>	<i>NSS5: 10</i>	<i>NSS4: 10</i>	<i>NDFF: 5</i>
hyper no. 5	value: 111225	NS: 10	NSS5: 27	NSS4: 27	NDFF: 14
hyper no. 6	value: 111234	NS: 20	NSS5: 58	NSS4: 58	NDFF: 20
<i>hyper no. 7</i>	<i>value: 111333</i>	<i>NS: 4</i>	<i>NSS5: 11</i>	<i>NSS4: 11</i>	<i>NDFF: 0</i>
hyper no. 8	value: 112224	NS: 10	NSS5: 26	NSS4: 26	NDFF: 12
hyper no. 9	value: 112233	NS: 16	NSS5: 44	NSS4: 44	NDFF: 16
hyper no. 10	value: 122223	NS: 5	NSS5: 17	NSS4: 17	NDFF: 12
<b>hyper no. 11</b>	<b>value: 222222</b>	<b>NS: 1</b>	<b>NSS5: 0</b>	<b>NSS4: 0</b>	<b>NDFF: 0</b>

**ni = 7**

hyper no. 1	value: 1 1 1 1 1 1 6	NS: 1	NSS5: 2	NSS4: 2	NDFP: 0
hyper no. 2	value: 1 1 1 1 1 2 5	NS: 6	NSS5: 20	NSS4: 20	NDFP: 10
hyper no. 3	value: 1 1 1 1 1 3 4	NS: 6	NSS5: 24	NSS4: 24	NDFP: 12
hyper no. 4	value: 1 1 1 1 2 2 4	NS: 15	NSS5: 56	NSS4: 56	NDFP: 28
hyper no. 5	value: 1 1 1 1 2 3 3	NS: 15	NSS5: 58	NSS4: 58	NDFP: 21
hyper no. 6	value: 1 1 1 2 2 2 3	NS: 20	NSS5: 80	NSS4: 80	NDFP: 46
hyper no. 7	value: 1 1 2 2 2 2 2	NS: 3	NSS5: 12	NSS4: 12	NDFP: 9

**ni = 8**

hyper no. 1	value: 1 1 1 1 1 1 1 5	NS: 1	NSS5: 4	NSS4: 4	NDFP: 2
hyper no. 2	value: 1 1 1 1 1 1 2 4	NS: 7	NSS5: 34	NSS4: 34	NDFP: 20
<i>hyper no. 3</i>	<i>value: 1 1 1 1 1 1 3 3</i>	<i>NS: 4</i>	<i>NSS5: 21</i>	<i>NSS4: 21</i>	<i>NDFP: 11</i>
hyper no. 4	value: 1 1 1 1 1 2 2 3	NS: 21	NSS5: 108	NSS4: 108	NDFP: 62
<i>hyper no. 5</i>	<i>value: 1 1 1 1 2 2 2 2</i>	<i>NS: 10</i>	<i>NSS5: 51</i>	<i>NSS4: 51</i>	<i>NDFP: 34</i>

**ni = 9**

hyper no. 1	value: 1 1 1 1 1 1 1 1 4	NS: 1	NSS5: 6	NSS4: 6	NDFP: 4
hyper no. 2	value: 1 1 1 1 1 1 1 2 3	NS: 8	NSS5: 52	NSS4: 52	NDFP: 34
<i>hyper no. 3</i>	<i>value: 1 1 1 1 1 1 2 2 2</i>	<i>NS: 10</i>	<i>NSS5: 66</i>	<i>NSS4: 66</i>	<i>NDFP: 48</i>

**ni = 10**

hyper no. 1	value: 1 1 1 1 1 1 1 1 1 3	NS: 1	NSS5: 8	NSS4: 8	NDFP: 6
<i>hyper no. 2</i>	<i>value: 1 1 1 1 1 1 1 1 2 2</i>	<i>NS: 5</i>	<i>NSS5: 41</i>	<i>NSS4: 41</i>	<i>NDFP: 33</i>

**ni = 11**

hyper no. 1	value: 1 1 1 1 1 1 1 1 1 1 2	NS: 1	NSS5: 10	NSS4: 10	NDFP: 9
-------------	------------------------------	-------	----------	----------	---------

**ni = 12**

<i>hyper no. 1</i>	<i>value: 1 1 1 1 1 1 1 1 1 1 1 1</i>	<i>NS: 1</i>	<i>NSS5: 12</i>	<i>NSS4: 12</i>	<i>NDFP: 12</i>
--------------------	---------------------------------------	--------------	-----------------	-----------------	-----------------

\*  
\* \*

## APPENDIX E: ADDITIONAL GRAPHS FOR OCTAVE GENERATIONS WITH THE EXTENDED ALPHABET

The database of *systems*<sup>273</sup> with the extended alphabet (2 to 24-quarter-tones intervals) is available (raw results from computer program Modes V. 5) in Appendix J, downloadable at <http://nemo-online.org/articles>.

Additional remarks:

- NSSU\_NR: Number of Sub-Systems in Unitary weighting with the Non-redundant sub-systems excluded (Unitary)
- NSS5U\_NR: Unitary number of non-redundant sub-systems with a direct fifth (or fourth)
- DQQU\_NR (“*nombre de sous-systèmes Non Redondants en Double Quarte ET Quinte justes – Unitaire*”): Unitary number of non-redundant sub-systems with a direct fourth in a fifth
- D\_QQ: test on the presence of a just fourth AND a just fifth beginning with the first interval
- “umin”: ‘ultra-min’ criterion for the detection of suites of three (or more) semi-tones (‘1’) in a row
- “max”: ‘max’ criterion for the detection of suites of two (or more) intervals equal or superior to ‘it\_maxc’ (the latter’s value is set for this generation to ‘3’ semi-tones)
- “\umin”: ‘non-ultra-min’ – without suites of three (or more) semi-tones (‘1’) in a row
- “\max”: ‘non-max’ – without suites of two (or more) intervals equal or superior to ‘it\_maxc’ (the latter’s value is set for this generation to ‘3’ semi-tones)

### 1. Semi-tone generations

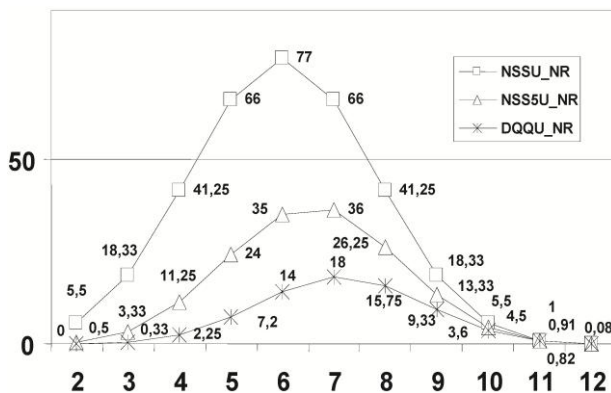

FHT 1 Evolution with NI of the numbers of non-redundant systems in Unitary (weighted) variables, with test on the presence of a fourth AND fifth (DQQU\_NR); f(NI): ½ tone, NR, complete alphabet (compare with Fig. 47: 56).

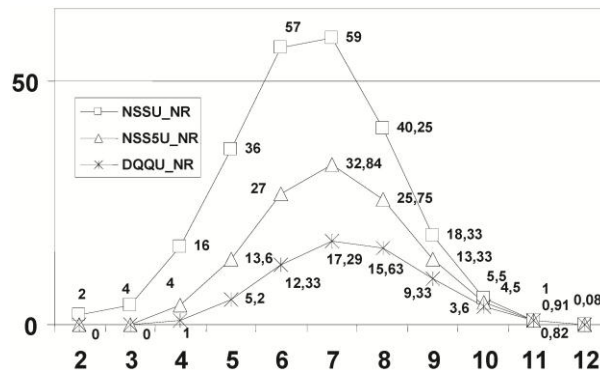

FHT 2 As previous figure, with \max criterion (compare with Fig. 51: 58).

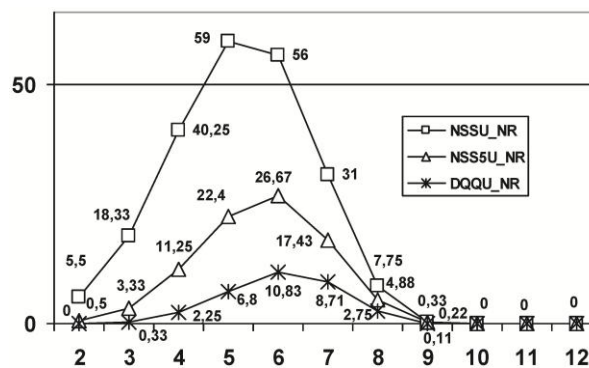

FHT 3 As above, but with \umin criterion instead (compare with Fig. 49: 58).

<sup>273</sup> Sub-systems can be deduced by de-ranking the systems.

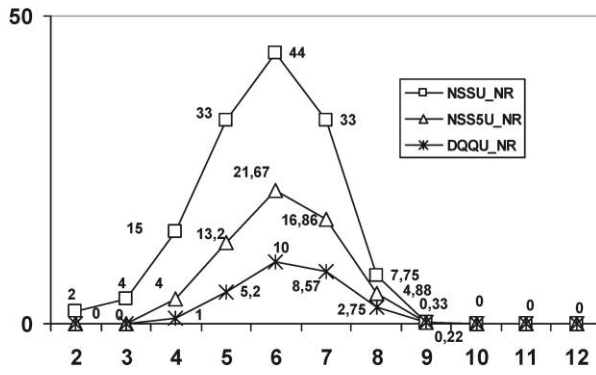

FHT 4 As above, but with both \umin and \max criteria applied (compare with Fig. 53: 59).

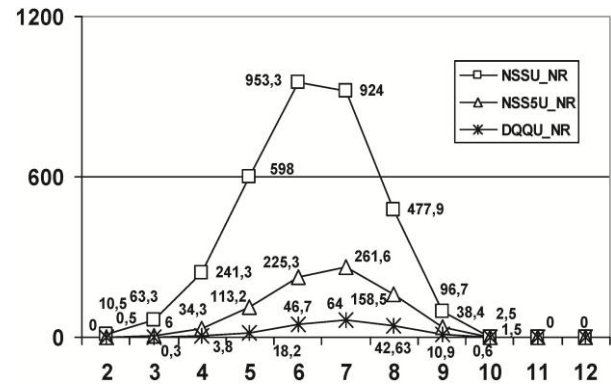

FHT 7 As previous figure, but with the \umin filter applied (compare with Fig. 50: 58).

## 2. Quarter-tone generations

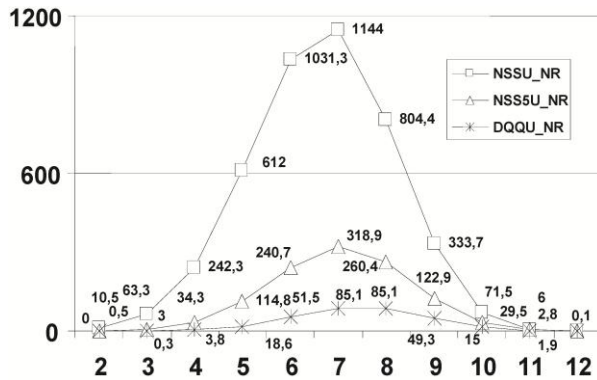

FHT 5 Evolution with NI of the numbers of non-redundant systems in Unitary (weighted) variables, with test on the presence of a fourth AND fifth (DQQU\_NR); f(NI): ¼ tone, NR, extended alphabet (the one-quarter-tone interval is excluded – compare with Fig. 48: 57).

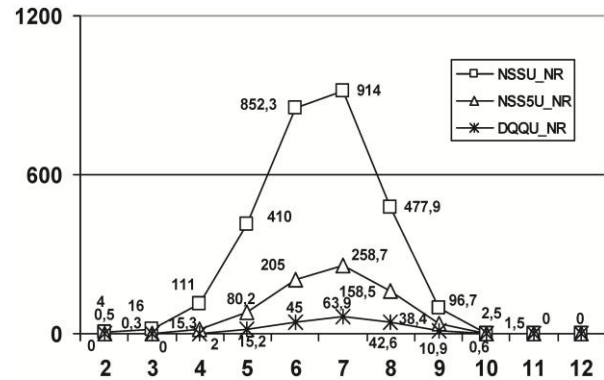

FHT 8 As above, but with both filters \umin and \max(6) applied (compare with Fig. 54: 59).

\* \*

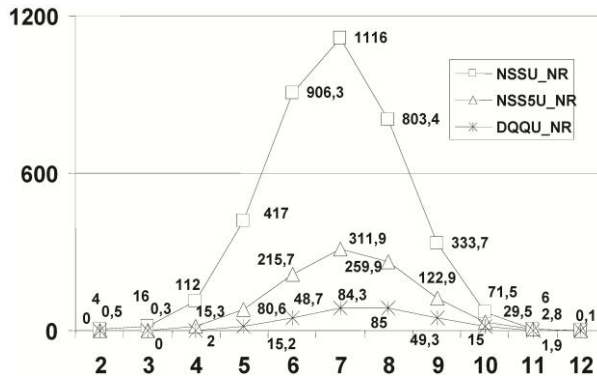

FHT 6 As above, but with the \max(6) filter applied (compare with Fig. 52: 58).

APPENDIX F: SYNOPTIC RESULTS FOR THE QUARTER-TONE GENERATIONS, WITH THE SMALLEST CONCEPTUAL INTERVAL (*imin*) SET TO “2” QUARTER-TONES AND NO LIMITATIONS FOR THE LARGEST INTERVAL

Remarks:

- Smallest interval in use: 2 quarter-tones
- Largest interval in use: 24 quarter-tones
- Range of NI: 2 to 12
- Presence of a direct fifth: ‘D. fifth’
- Presence of a direct fourth: ‘D. fourth’
- Conjunct two semi-tones: ‘min’
- Conjunct three semi-tones: ‘umin’
- Conjunct big intervals (6 quarter-tones or greater): ‘max’
- ‘R+’: including redundancies
- ‘R-’: excluding redundancies
- Filters excluding sub-systems (‘NON’) are preceded by ‘\’

NI	Subdivisions	Without filters		\max (6)		\min		\min AND \max		\umin		\umin AND \ max	
		R +	R -	R +	R -	R +	R -	R +	R -	R +	R -	R +	R -
2	systems	11	10.5	4	4	11	10.5	4	4	11	10.5	4	4
	sub-systems: - D. fifth	.5	.5	0	0	.5	.5	0	0	.5	.5	0	0
	- D. fourth	.5	.5	0	0	.5	.5	0	0	.5	.5	0	0
	- D. fifth AND D. fourth	0	0	0	0	0	0	0	0	0	0	0	0
3	systems	64	63.33	16	16	63	62.33	15	15	64	63.33	16	16
	sub-systems: - D. fifth	6	6	.33	.33	6	6	.33	.33	6	6	.33	.33
	- D. fourth	6	6	.33	.33	6	6	.33	.33	6	6	.33	.33
	- D. fifth AND D. fourth	.33	.33	0	0	.33	.33	0	0	.33	.33	0	0
4	systems	245	242.25	114	112	229	226.25	107	105	244	241.25	113	111
	sub-systems: - D. fifth	34.5	34.25	15.5	15.25	33	32.75	15.5	15.25	34.5	34.25	15.5	15.25
	- D. fourth	34.5	34.25	15.5	15.25	33	32.75	15.5	15.25	34.5	34.25	15.5	15.25
	- D. fifth AND D. fourth	3.75	3.75	2	2	3.5	3.5	2	2	3.75	3.75	2	2
5	systems	612	612	417	417	507	507	355	355	598	598	410	410
	sub-systems: - D. fifth	114.8	114.81	80.6	80.6	97.6	97.6	71	71	113.2	113.2	80.2	80.2
	- D. fourth	114.8	114.81	80.6	80.6	97.6	97.6	71	71	113.2	113.2	80.2	80.2
	- D. fifth AND D. fourth	18.6	18.6	15.2	15.2	14.8	14.8	13	13	18.2	18.2	15.2	15.2
6	systems	1038	1031.33	913	906.33	679	672.83	628	621.83	960	953.33	859	852.33
	sub-systems: - D. fifth	242.17	240.67	217.17	215.67	162.17	161	153.67	152.5	226.83	225.33	26.5	205
	- D. fourth	242.17	240.67	217.17	215.67	162.17	161	153.67	152.5	226.83	225.33	26.5	205
	- D. fifth AND D. fourth	51.67	51.5	48.83	48.67	30	30	30	30	46.83	46.67	45.17	45

FHT 9 Synoptic table (1): Results for the quarter-tone generations, with the smallest conceptual interval (*imin*) set to “2” quarter-tones and no limitations for the largest interval

NI	Subdivisions	Without filters		\max (6)		\min		\min AND \max		\umin		\umin AND \max	
		R +	R-	R +	R-	R +	R-	R +	R-	R +	R-	R +	R-
7	systems	1144	1144	1116	1116	474	474	473	473	924	924	914	914
	sub-systems: - D. fifth	318.86	318.86	311.86	311.86	134.86	134.86	134.57	134.57	261.57	261.57	258.71	258.71
	- D. fourth	318.86	318.86	311.86	311.86	134.86	134.86	134.57	134.57	261.57	261.57	258.71	258.71
	- D. fifth AND D. fourth	85.29	85.29	84.29	84.29	27.29	27.29	27.29	27.29	64	64	63.86	63.86
8	systems	810	804.58	809	803.38	142	138.38	142	138.38	483	477.88	483	477.88
	sub-systems: - D. fifth	262	260.38	262	259.88	46	45	46	45	160.25	158.5	160.25	158.5
	- D. fourth	262	260.38	262	259.88	46	45	46	45	160.25	158.5	160.25	158.5
	- D. fifth AND D. fourth	85.75	85.13	85.63	85	7.75	7.75	7.75	7.75	43	42.63	43	42.63
9	systems	335	333.67	335	333.67	9	8.33	9	8.33	98	96.67	98	96.67
	sub-systems: - D. fifth	123	122.89	123.56	122.89	3.78	3.56	3.78	3.56	39.11	38.44	39.11	38.44
	- D. fourth	123	122.89	123.56	122.89	3.78	3.56	3.78	3.56	39.11	38.44	39.11	38.44
	- D. fifth AND D. fourth	49.56	49.33	49.56	49.33	.56	.56	.56	.56	11.11	10.89	11	10.89
10	systems	73	71.5	73	71.5	0	0	0	0	3	2.5	3	2.5
	sub-systems: - D. fifth	30	29.5	30.5	29.5	0	0	0	0	1.8	1.5	1.8	1.5
	- D. fourth	30	29.5	30.5	29.5	0	0	0	0	1.8	1.5	1.8	1.5
	- D. fifth AND D. fourth	15.6	15	15.6	15	0	0	0	0	.7	.6	.7	.6
11	systems	6	6	6	6	0	0	0	0	0	0	0	0
	sub-systems: - D. fifth	2.82	2.82	2.82	2.82	0	0	0	0	0	0	0	0
	- D. fourth	2.82	2.82	2.82	2.82	0	0	0	0	0	0	0	0
	- D. fifth AND D. fourth	1.91	1.91	1.91	1.91	0	0	0	0	0	0	0	0
12	systems	1	.08	1	.8	0	0	0	0	0	0	0	0
	sub-systems: - D. fifth	1	.08	1.0	.08	0	0	0	0	0	0	0	0
	- D. fourth	1	.08	1.0	.08	0	0	0	0	0	0	0	0
	- D. fifth AND D. fourth	1	.08	1	.08	0	0	0	0	0	0	0	0

FHT 10 Synoptic table (2): Results for the quarter-tone generations, with the smallest conceptual interval (imin) set to “2” quarter-tones and no limitations for the largest interval.

\*  
\* \*

## APPENDIX G: OCTAVIAL SCALES WITH LIMITED TRANSPOSITION – WITH AN ADDENDUM FOR SCALE ELEMENTS IN THE FOURTH AND IN THE FIFTH<sup>274</sup>

With interval combination, we frequently find redundant (or hyper-redundant, when the hyper-system is completely redundant) combinations, of which the Western equivalents are the scales with limited transposition. I explore here, apart from the filtering process used for identifying (and eliminating) such sub-systems in the general database of sub-systems used in my thesis, the reverse process, *i.e.* applying formulae for the (nearly) direct obtainment (and understanding) of such scales.

\*  
\* \*

Let us first explore two examples of redundant systems:

1. The tone-scale of Debussy (2 2 2 2 2 2 in multiples of the semi-tone).
2. Scale (“mode”) no. 3 of Messiaen’s (1 1 2 1 1 2 1 1 2) with nine intervals to the octave.<sup>275</sup>

In the first case (Debussy – hyper-redundant system), de-ranking the first interval(s) will always give the same system (2 2 2 2 2) which is equivalent to its sub-systems; in the case of scale 1 1 2 1 1 2 1 1 2 (a redundant system with limited transposition), sub-systems generated by a de-ranking (here also a rotation) process will all be redundant beginning with the fourth de-ranking<sup>276</sup>) and give equivalent scales to the first three (*i.e.*: 1 1 2 1 1 2 1 1 2, 1 2 1 1 2 1 1 2 1, 2 1 1 2 1 1 2 1 1).

<sup>274</sup> This appendix is an extension of a footnote in the 2010 version of this article; it is also part of a course on Modal systematics I taught at a Lebanese university in the summer of 2007, and of the original French version of this article, which was proposed to Musicological reviews in France (and not accepted for publication). Audio examples, together with a simplified presentation of redundant sub-systems and systems, are provided in the dedicated Power Point show (downloadable at <http://nemo-online.org/articles>).

<sup>275</sup> Messiaen’s scales with limited transposition are taken from Vol. 1 of [Nelson, 1992].

<sup>276</sup> Reminder: the first de-ranking gives the original system.

### *Completely redundant systems*

Scales such as Debussy’s (the first case above, a hyper-redundant system with all identical intervals) can be characterized with the formula:

- $i \cdot N = S$ , with  $2 \leq i \leq S$  and  $1 \leq N \leq S$  (1)
  - to be read: “For any given number of repetitions ‘i’ of an integer (interval), with value comprised between 2 and the total integer sum S of a combination (of integer intervals), there exists at least one integer (interval) N, with value comprised between 1 and S, which divides i multiplied by S”.

In formula (1), i, N, and S are integers. ‘i’ is the number of times the interval is repeated (six times in Debussy’s scale) within a combination (two intervals are at least needed to form a combination); ‘N’ is the numerical value of the interval (2 in Debussy’s scale), while ‘S’ is the sum of the intervals in the combination (in this case, 12 semi-tones).

The corollary of formula (1) is that for any sum S having a divider  $i \geq 2$ , there is at least one hyper-redundant sub-system in the set.

#### PARTICULAR CASE OF THE SEMI-TONAL MODEL WITH THE SUM $S = 12$

In the case when  $S = 12$ , dividers of S are 1, 2, 3, 4, 6 and 12; for dividers greater than 1, we find the following hyper-redundant systems:

- $2 \cdot N = 12$ ,  $N = 6$ , with system 6 6, two tritones in the octave.
- $3 \cdot N = 12$ ,  $N = 4$ , with system 4 4 4, three ditones to the octave.
- $4 \cdot N = 12$ ,  $N = 3$ , with system 3 3 3 3, three one-and-a-half-tones to the octave.
- $6 \cdot N = 12$ ,  $N = 6$ , Debussy’s scale (system) 2 2 2 2 2 2, with six tones to the octave.
- $12 \cdot N = 12$ ,  $N = 12$ , with the obvious 1 1 1 1 1 1 1 1 1 1 1 1, twelve semi-tones to the octave.

### Formulae for the general case of redundancy

The general case (with 1 1 2 1 1 2 1 1 2 as an example) can be formulated:

- $i * \sum N_j = S$ , with  $1 \leq i \leq S$ ,  $1 \leq j \leq j_{\max}$ ,  $1 \leq j_{\max} \leq S$  and  $1 \leq N \leq S$  (2)
- $i$  is the number of repetitions of an intervallic suite (a combination of integers) within the octave (a delimited set of integers),
- $N_1, N_2, \dots, N_j$  are the successive intervals of the repeated combination in the set,
- $S$  is (still) the sum of the intervals (integers) forming the set,
- $j_{\max}$  is the upper bound of  $j$ .

By definition (formula 2),  $i$  and  $\sum N_j$  divide  $S$ ; the case of hyper-redundancy is a particular case of formula (2), with  $j = j_{\max} = 1$  and  $N_1 = N_2 = \dots = N$ . Applying formula (2) with the 1 1 2 1 1 2 1 1 2 semi-tonal octavial system, we have,  $i = 3$ ,  $N_1 = 1$  as well as  $N_2$ ;  $N_3$  is 2 with  $S = 12$ , while  $i (= 3)$  and  $\sum N_j (= 4)$  divide  $S (= 12)$  – see FHT 11.

$$\dots i = 3, j = 1 \text{ to } 3, j_{\max} = 3$$

$$\overbrace{1 + 1 + 2} + \overbrace{1 + 1 + 2} + \overbrace{1 + 1 + 2} = 12$$

$$(N_1 + N_2 + N_3) + (N_1 + N_2 + N_3) + (N_1 + N_2 + N_3) = S$$

FHT 11 Applying formula (2) for generating redundant sub-systems to Messiaen's "mode no. 3".

Let  $NI$  be the total number of intervals to the octave, then (applying formula 2):

- $NI = i * j_{\max}$ , with  $2 \leq NI \leq S$ ,  $1 \leq i \leq S$  and  $1 \leq j_{\max} \leq S$  (3)

then apply this formula back to hyper-redundant systems.

### A necessary and sufficient condition for the obtainment of hyper-redundant systems

By definition of formula (3),  $i$  and  $j_{\max}$  divide  $NI$ .  $NI$  is comprised between (and including) 2 and  $S$  for the obvious reasons that a combination can only exist if it has 2 or more intervals, while this number of intervals cannot exceed the total number of intervals that can be

fit in the scale ( $= S$  if all intervals are equal to 1, or semi-tones in the semi-tone model for example)<sup>277</sup>.

In the particular case when  $j_{\max} = 1$ ,  $NI = i$  (hyper-redundant systems), and with  $i$  being by definition a divider of  $S$  (formula 2) as well as a divider of  $NI$  (formula 3), a necessary condition for the existence of hyper-redundant systems with  $NI$  intervals to the octave is the existence of a common divider  $i$  for  $NI$  and  $S$ ; it shall be demonstrated that this condition is also sufficient.

#### SUFFICIENT CONDITION FOR THE OBTAINMENT OF HYPER-REDUNDANT SYSTEMS

Let  $i$  be a common divider of numbers  $NI$  and  $S$ , with  $NI \leq S$ ; applying formulae (2) and (3) above we deduce formulae (4) and (4'):

- $(NI/j_{\max}) * \sum N_j = S$ , with  $1 \leq i \leq S$ ,  $2 \leq NI \leq S$ ,  $1 \leq j \leq j_{\max}$  and  $1 \leq j_{\max} \leq S$  (4)

or

- $NI = (S * j_{\max}) / \sum N_j$ , with  $1 \leq i \leq S$ ,  $2 \leq NI \leq S$ ,  $1 \leq j \leq j_{\max}$  and  $1 \leq j_{\max} \leq S$  (4')

This proposition can only be true if  $\sum N_j$  divides  $(S * j_{\max})$ : while  $\sum N_j$  is a divider of  $S$  (formula 2),  $\sum N_j$  is then a divider of  $(S * j_{\max})$  for all possible cases, provided that  $i$  is a common divider of  $NI$  and  $S$ , QED.

### Redundant systems in the semi-tone model

For a semi-tone octavial model, formula (2) – *redundant systems* – is reformulated thus:

- $i * \sum N_j = 12$ , with  $1 \leq i \leq 12$ ,  $1 \leq j \leq 12$  and  $1 \leq N \leq 12$  (2')

Dividers of 12 greater than 1 are 2, 3, 4, 6 and 12; corresponding values for  $\sum N_j$  are:

- for  $i = 2$ ,  $\sum N_j = 6$ ,  $j_{\max} = 6$
- for  $i = 3$ ,  $\sum N_j = 4$ ,  $j_{\max} = 4$
- for  $i = 4$ ,  $\sum N_j = 3$ ,  $j_{\max} = 3$
- for  $i = 6$ ,  $\sum N_j = 2$ ,  $j_{\max} = 2$
- for  $i = 12$ ,  $\sum N_j = 1$ ,  $j_{\max} = 1$

It is then sufficient to find, for each value of  $i$ , all possible combinations for  $j$  intervals (with  $1 \leq j \leq 12$ ):

<sup>277</sup> In the quarter-tone model with extended alphabet (one-quarter-tone intervals excluded, this would be  $S/2$ ).

❖ for  $i=2, \Sigma N_j=6, j_{\max}=6$ :

➤  $j=1, N_1=6, NI=2 \rightarrow 6\ 6$  – **hyper-redundant**

➤  $(i^*N_1=12):NI=2, j=2, NI=4$

- $N_1=1, N_2=5 \rightarrow 1\ 5\ 1\ 5$
- $N_1=2, N_2=4 \rightarrow 2\ 4\ 2\ 4$
- $N_1=3, N_2=3 \rightarrow 3\ 3\ 3\ 3$  – **hyper-redundant**
- $N_1=4, N_2=2 \rightarrow 4\ 2\ 4\ 2$  – equivalent to case ii above<sup>278</sup>
- $N_1=5, N_2=1 \rightarrow 5\ 1\ 5\ 1$  – equivalent to case i above

➤  $j=3, NI=6$

- $N_1=1, N_2=1, N_3=4 \rightarrow 1\ 1\ 4\ 1\ 1\ 4$
- $N_1=1, N_2=2, N_3=3 \rightarrow 1\ 2\ 3\ 1\ 2\ 3$
- $N_1=1, N_2=3, N_3=2 \rightarrow 1\ 3\ 2\ 1\ 3\ 2$
- $N_1=1, N_2=4, N_3=1 \rightarrow 1\ 4\ 1\ 1\ 4\ 1$  – equivalent to case i above
- $N_1=2, N_2=1, N_3=3 \rightarrow 2\ 1\ 3\ 2\ 1\ 3$  – equivalent to case iii above
- $N_1=2, N_2=2, N_3=2 \rightarrow 2\ 2\ 2\ 2\ 2\ 2$  – **hyper-redundant**
- $N_1=2, N_2=3, N_3=1 \rightarrow 2\ 3\ 1\ 2\ 3\ 1$  – equivalent to case ii above
- $N_1=3, N_2=1, N_3=2 \rightarrow 3\ 1\ 2\ 3\ 1\ 2$  – equivalent to case ii above
- $N_1=3, N_2=2, N_3=1 \rightarrow 3\ 2\ 1\ 3\ 2\ 1$  – equivalent to case iii above
- $N_1=4, N_2=1, N_3=1 \rightarrow 4\ 1\ 1\ 4\ 1\ 1$  – equivalent to case i above

➤  $j=4, NI=8$

- $N_1=1, N_2=1, N_3=1, N_4=3 \rightarrow 1\ 1\ 1\ 3\ 1\ 1\ 1\ 3$
- $N_1=1, N_2=1, N_3=2, N_4=2 \rightarrow 1\ 1\ 2\ 2\ 1\ 1\ 2\ 2$
- $N_1=1, N_2=1, N_3=3, N_4=1 \rightarrow 1\ 1\ 3\ 1\ 1\ 1\ 3\ 1$  – equivalent to case i above
- $N_1=1, N_2=2, N_3=1, N_4=2 \rightarrow 1\ 2\ 1\ 2\ 1\ 2\ 1\ 2$
- $N_1=1, N_2=2, N_3=2, N_4=1 \rightarrow 1\ 2\ 2\ 1\ 1\ 2\ 2\ 1$  – equivalent to case ii above
- $N_1=1, N_2=3, N_3=1, N_4=1 \rightarrow 1\ 3\ 1\ 1\ 1\ 3\ 1\ 1$  – equivalent to case i above

•  $N_1=2, N_2=1, N_3=1, N_4=2 \rightarrow 2\ 1\ 1\ 2\ 2\ 1\ 1\ 2$  – equivalent to case ii above

•  $N_1=2, N_2=1, N_3=2, N_4=1 \rightarrow 2\ 1\ 2\ 1\ 2\ 1\ 2\ 1$  – equivalent to case iv above

•  $N_1=2, N_2=2, N_3=1, N_4=1 \rightarrow 2\ 2\ 1\ 1\ 2\ 2\ 1\ 1$  – equivalent to case ii above

•  $N_1=3, N_2=1, N_3=1, N_4=1 \rightarrow 3\ 1\ 1\ 1\ 3\ 1\ 1\ 1$  – equivalent to case i above

➤  $j=5, NI=10: N_1=1, N_2=1, N_3=1, N_4=1, N_5=2 \rightarrow 1\ 1\ 1\ 1\ 2\ 1\ 1\ 1\ 1\ 2$  – other cases are all equivalent

➤  $j=6, NI=12: N_1=1, N_2=1, N_3=1, N_4=1, N_5=1, N_6=1 \rightarrow 1\ 1\ 1\ 1\ 1\ 1\ 1\ 1\ 1\ 1\ 1\ 1$  – **hyper-redundant**

COMPLETE CATALOGUE OF REDUNDANT SYSTEMS AND SUB-SYSTEMS IN THE SEMI-TONE MODEL

➤ **NI=2**

- **6 6: hyper-redundant, (c f# c' or do fa# do)**  
composing 8.33 % of the sub-systems modeled with NI=2

➤ **NI=3**

- **4 4 4: hyper-redundant, (c e g# c' or do mi sol# do)**  
composing 3.51 % of the sub-systems modeled with NI=3

➤ **NI=4**

- **1 5 1 5: redundant in positions 3 and 4 (c d# f# g c' or do re# fa# sol do)**
- **2 4 2 4: redundant in positions 3 and 4 (c d f# g# c' or do re fa# sol# do)**
- **3 3 3 3: hyper-redundant, (c e# f# a c' or do mi# fa# la do)**  
composing 4.07 % of the sub-systems modeled with NI=4

➤ **NI=6**

- **1 1 4 1 1 4: redundant in positions 4, 5 and 6 (Messiaen's mode M5, 6 notations) (c d# d or e#b f# g a# c' or do re# re fa# sol la# do)**
- **1 3 1 3 1 3: redundant in positions 3, 4, 5 and 6 (c d# e f g# a c' or do re# mi fa sol# la do)**

<sup>278</sup> Redundant sub-systems are shown in italics, hyper-redundant systems in bold font.

- 1 2 3 1 2 3: *redundant in positions 4, 5 and 6* ( $c d^b e^f g a c'$  or  $do r\acute{e} m\grave{i} f\acute{a}\# sol la do$ )
  - 1 3 2 1 3 2: *redundant in positions 4, 5 and 6* ( $c d^b e^f g a\# c'$  or  $do r\acute{e} m\grave{i} f\acute{a}\# sol la\# do$ )
  - **2 2 2 2 2 2: hyper-redundant (Messiaen's mode M1, 2 notations)** ( $c d e f\# g\# a\# c'$  or  **$do r\acute{e} m\grave{i} f\acute{a}\# sol\# la\# do$** )  
composing 3.75 % of the sub-systems modeled with NI=6
- **NI=8**
- 1 1 1 3 1 1 1 3: *redundant in positions 5, 6, 7 and 8* (Messiaen's mode M4, 6 notations) ( $c d^b d e^b f\# g a^b b c'$  or  $do r\acute{e} r\acute{e} m\grave{i} f\acute{a}\# sol la^b si do$ )
  - 1 1 2 2 1 1 2 2: *redundant in positions 5, 6, 7 and 8* (Messiaen's mode M6, 6 notations) ( $c d^b d e f\# g a^b b^b c'$  or  $do r\acute{e} r\acute{e} m\grave{i} f\acute{a}\# sol la^b si do$ )
  - 1 2 1 2 1 2 1 2: *redundant in positions 3, 4, 5, 6, 7 and 8* (Messiaen's mode M2, 3 notations) ( $c d^b e^b e f\# g a b^b c'$  or  $do r\acute{e} r\acute{e} m\grave{i} f\acute{a}\# sol la^b si do$ )  
composing 4.07 % of the sub-systems modeled with NI=8
- **NI=9**
- 1 1 2 1 1 2 1 1 2: *redundant in positions 3, 4, 5, 6, 7 and 8* (Messiaen's mode M3, 4 notations) ( $c d^b d e f g^b a^b a b^b c'$  or  $do r\acute{e} r\acute{e} m\grave{i} f\acute{a}\# sol la^b si do$ )  
composing 3.51 % of the sub-systems modeled with NI=9
- **NI=10**
- 1 1 1 1 2 1 1 1 1 2: *redundant in positions 6, 7, 8, 9 and 10* (Messiaen's mode M7, 6 notations) ( $c d^b d e^b e f\# g a^b a b^b c'$  or  $do r\acute{e} r\acute{e} m\grave{i} f\acute{a}\# sol la^b si do$ )  
composing 8.33 % of the sub-systems modeled with NI=10
- **NI=12**
- **1 1 1 1 1 1 1 1 1 1 1 1: hyper-redundant (integrally chromatic)**  
composing 91.67 % of the sub-systems modeled with NI=12
- COMPLETE CATALOGUE OF SUPPLEMENTARY REDUNDANT SYSTEMS IN THE QUARTER-TONE MODEL
- **NI=2** : no supplementary sub-system
- **NI=3** : no supplementary sub-system
- **NI=4** (1.12 %)
- 3 9 3 9: red. in positions 3 and 4
  - 5 7 5 7: red. in positions 3 and 4
- **NI=6** (0.64 %)
- 2 3 7 2 3 7: red. in positions 4, 5 and 6
  - 2 7 3 2 7 3: red. in positions 4, 5 and 6
  - 2 5 5 2 5 5: red. in positions 4, 5 and 6
  - 3 3 6 3 3 6: red. in positions 4, 5 and 6
  - 3 5 3 5 3 5: red. in positions 3, 4, 5 and 6
  - 3 4 5 3 4 5: red. in positions 4, 5 and 6
  - 3 5 4 3 5 4: red. in positions 4, 5 and 6
- **NI=8** (0.69 %)
- 2 2 3 5 2 2 3 5 : red. in positions 5, 6, 7 and 8
  - 2 2 5 3 2 2 5 3 : red. in positions 5, 6, 7 and 8
  - 2 3 2 5 2 3 2 5: red. in positions 5, 6, 7 and 8
  - 2 3 3 4 2 3 3 4: red. in positions 5, 6, 7 and 8
  - 2 3 4 3 2 3 4 3: red. in positions 5, 6, 7 and 8
  - 2 4 3 3 2 4 3 3: red. in positions 5, 6, 7 and 8
  - **3 3 3 3 3 3 3 3: hyper-redundant**
- **NI=9** (0.40 %)
- 2 3 3 2 3 3 2 3 3: red. in positions 3, 4, 5, 6, 7 and 8
- **NI=10** (2.05 %)
- 2 2 2 3 3 2 2 2 3 3: red. in positions 6, 7, 8, 9 and 10
  - 2 2 3 2 3 2 2 3 2 3: red. in positions 6, 7, 8, 9 and 10
- **NI=12** : no supplementary sub-system

## Conclusions

Two main formulae have been proposed for the obtainment of redundant systems in the models proposed in this study (quarter-tone and semi-tone); firstly, a formula for hyper-redundant systems:

$$\text{➤ } i \cdot N = S, \text{ with } 2 \leq i \leq S \text{ and } 1 \leq N \leq S \text{ (1)}$$

in which  $i$ ,  $N$ , and  $S$  are integers. “ $i$ ” is the number of times the interval is repeated within a combination; “ $N$ ” is the numerical value of the interval, while “ $S$ ” is the sum of the intervals in the combination (in this case, 12 semi-tones).

Secondly, I proposed a formula for the general case of redundancy:

$$\text{➤ } i \cdot \sum N_j = S, \text{ with } 1 \leq i \leq S, 1 \leq j \leq j_{\max}, 1 \leq j_{\max} \leq S \text{ and } 1 \leq N \leq S \text{ (2)}$$

in which:

- $i$  is the number of repetitions of an intervallic suite within the octave,
- $N_1, N_2, \dots, N_j$  are the successive intervals of the repeated combination in the set,
- $S$  is the sum of the intervals forming the set,
- $j_{\max}$  is the upper bound of  $j$ .

It is possible, with the help of these formulae and their corollaries (shown above) to find manually all redundant sub-systems in the models. Note that for both models (semi-tone and quarter-tone) pentatonic and heptatonic generations do not have redundant systems, as the numbers 5 and 7 do not divide either 12 or 24 (S).<sup>279</sup>

A necessary and sufficient condition for the obtainment of hyper-redundant systems is the existence of a common divider for  $NI$  (number of intervals in the scale) and  $S$  (integer sum of the intervals in the scale).

In both cases (semi-tone and quarter-tone models), there exists no redundant system for  $NI=5$  (pentatonism) and 7 (heptatonism), or for  $NI=11$ , because  $NI$  is in these cases is 1) a prime number that can be divided uniquely by itself or by one, and because 2) numbers 5, 7 and 11 do not divide either of

$S=12$  (with  $S$ =sum of the intervals in the system) in the semi-tone model or  $S=24$  in the quarter-tone one.

As a final note in what concerns octavial systems: for the semi-tone model, redundant sub-systems are 3.03 % of the total of sub-systems, while redundant sub-systems compose only 0.48 % of the total of sub-systems for the quarter-tone model.

## Addendum: About redundancy in the fourth and the fifth Containing intervals

Concerning the generations of “fourths” and “fifths” shown in Fig. 35 and Fig. 36, p. 46: in the case of the fourth, for  $NI=3$ ,  $NI$  is once again a prime number that does not divide the sum  $S=10$  (of quarter-tones), neither does it divide  $S=5$  (semi-tones). For the fifth, as is shown in the same figure, the usual four intervals in the fifth generate independent (distinct) sub-systems only in the case of the semi-tone model, as  $NI=4$  and  $S=7$ , and neither of the divisors of  $NI$  (i.e., the numbers 1, 2 and 4), except the trivial case 1, divides seven.

In the quarter-tone model, however,  $S=14$  for the fifth, and 2 divides fourteen so we may be able to find a suite of two ( $J$ ) intervals repeated twice ( $i$  times) systems provided that the sum of the two repeated intervals be equal to  $14/2=7$  (or  $S/i$ ); this is verified for the suites 4 3 (or a one-tone interval followed by a three-quarter-tone interval) or 3 4 and 2 5 (or 5 2) repeated twice.<sup>280</sup>

As for the fourth,  $NI=4$  with  $S=10$  have as common divider 2, which creates redundant combination with two couples of identical intervals (2 3) (2 3) and (3 2) (3 2), the sum of which ( $2+3=3+2=5$ ) is equal to  $S/i$  ( $10/2$ ) – see Fig. 25: 38.

\* \* \*

<sup>279</sup> Redundant sub-systems have been concomitantly filtered from the general database of sub-systems created as a tool for the thesis of the author, for verification of the aforementioned formulae and applications.

<sup>280</sup> See [Beyhom, 2003b, p.12–13] for the complete generation with the reduced alphabet 2 3 4 5 6 – hyper-systems 2 and 7.

## APPENDIX H: PERMUTATION PROCESSES FOR THE COMBINATION OF INTERVALS

Permutation exchanges one interval for another whilst others remain fixed. The same process is applied to another pair until all intervals have changed places.

With direct permutation (FHT 12), interval  $a_1$  of the basic configuration  $a_1 a_2 b_3$  is first changed with interval  $a_2$ . This results in combination  $a_2 a_1 b_3$ . Then, coming back to the original configuration, with  $b_3$ , which is the combination of  $b_3 a_2 a_1$ . As  $a_1$  has already changed places with the two other intervals, we proceed with the second interval of the basic configuration,  $a_2$ , with the others. This interval has already changed places, in the previous process, with  $a_1$ ; it should further change places with  $b_3$  only with

the combination  $a_1 b_3 a_2$ . The last interval has already changed places with both other intervals  $a_1$  and  $a_2$ , and this is where the process ends.

If  $a_1$  is different from  $a_2$ , and also from  $b_3$ , then the second combination:  $a_2 a_1 b_3$  is different from the first combination, because it is a stand-alone interval system. The total number of distinct interval systems which result from the direct permutation process is 4, that is one more than with the rotational process. If both intervals are the same, however, if  $a_1 = a_2$ , the two first combinations are equal. The process only gives three different combinations, similarly to those in the rotation process.

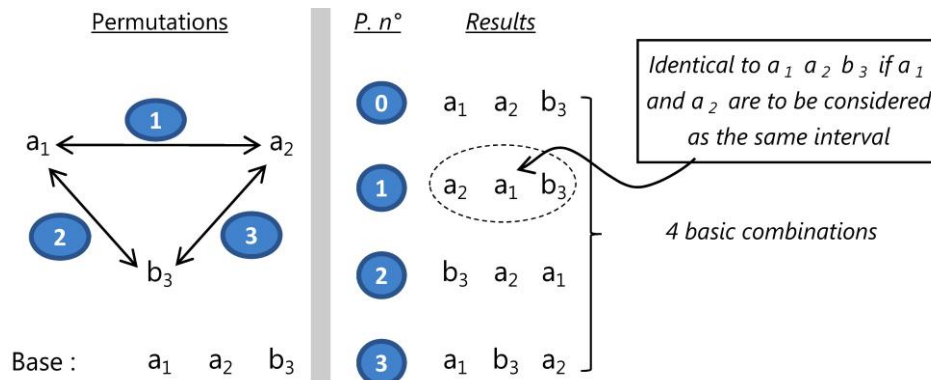

FHT 12 Permutation of three intervals.

In order to obtain the full range of possible combinations for these three intervals, we could apply the process of direct permutations, not only to the original configuration of  $a_1 a_2 b_3$ , but also to each of the combinations which result from the direct combinations of  $a_2 a_1 b_3$ ,  $b_3 a_2 a_1$  and  $a_1 b_3 a_2$ .

If we apply this process to the second in the direct permutation process, combination  $b_3 a_2 a_1$ , we obtain the following combinations:

1. New base:  $b_3 a_2 a_1$ . This is the second combination in the direct permutation process.
2. Combination no. 2:  $a_2 b_3 a_1$ , consisting in exchanging the first interval with the second. This is a new combination, different from all the previous ones.
3. Combination no. 3:  $a_1 a_2 b_3$ , consisting in exchanging the first interval in the new basic

configuration with the third one. This gives the same combination as the first one in the direct permutation process.

4. Combination no. 4:  $b_3 a_1 a_2$ , by exchanging the second interval in the new basic configuration with the third interval of the same. This is also a new combination.

Therefore we have two new interval combinations which added to the four distinct combinations of the direct permutation, amount to six different combinations of the three intervals  $a_1$ ,  $a_2$  and  $b_3$ . These amount to the possible combinations with three distinct intervals. There is no need to apply the permutation process for the other combinations stemming from the first direct process.

It is also possible to obtain a similar result with processes other than the successive permutations

method, for example by applying rotation followed by a direct permutation process (FHT 13).

In this combination process, a direct permutation process is applied to each of the combinations coming from an initial rotation process (Fig. 9: 19). This gives six independent and distinct combinations out of twelve. The six remaining combinations are redundant.

As a conclusion to this appendix, let us be reminded of two characteristics of the reviewed combination processes:

1. The successive, or consecutive permutations and the alternate rotation/permutation processes generate a certain number of redundant combinations which have to be excluded from the outcome.
2. Out of six distinct resulting combinations obtained, three will be redundant if  $a_1$  equals  $a_2$ . In this case, the outcome remains the same as for a simple rotation process (compare with Fig. 9).

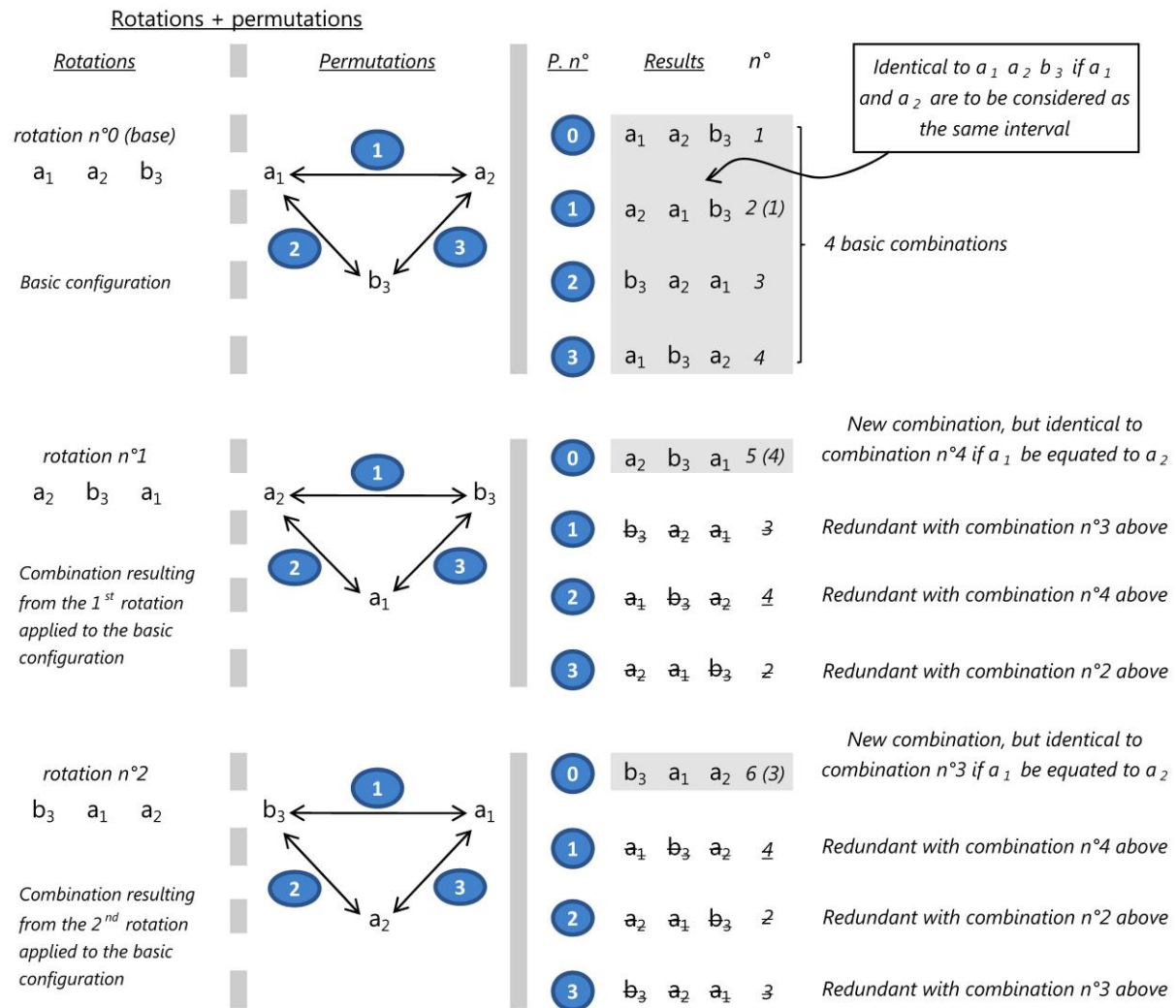

**FHT 13** Combining rotation and permutation for three intervals (the two ‘a’ are equal – if not, the numbers in subscript, which identify the initial ranks of each interval in the original basic configuration will differentiate them). The outcome here is 6 distinct combinations, but only 3 if ‘ $a_1$ ’ and ‘ $a_2$ ’ are identical. Remark: applying a rotation process (Fig. 9: 19) and a direct permutation process (FHT 12) to the combination  $a_1 \ a_2 \ b_3$  (i.e. adding the two combinations from rotation no. 1 and rotation no. 2 in this figure to the outcome of the permutation process for the basic combination  $a_1 \ a_2 \ b_3$ ) allows to find all six independent combinations, without redundancies except for the basic combination  $a_1 \ a_2 \ b_3$  itself.

## APPENDIX L: CORE GLOSSARY

This core glossary is a summary of the new (or renewed) concepts for characterizing intervals and their functions (for all these, see mainly Fig. 23: 30), for the arrangement of scales in Modal systematics, and for the rules and principles that structure intervals in the scale (these are mainly explained in Part II of the article).<sup>281</sup>

\* \*  
\* \*

## Intervals

Intervals in Modal music (and Modal systematics) may be characterized as *measuring*, *elementary*, *conceptual* and *Containing* (or *Container*):

- A *measuring interval* is an exact or approximate divider of other intervals: it may play no other role in the melody or the scale as the one of measuring these other intervals. It is generally the smallest interval of the scale in ET-systems (Equal-Temperament scales):
  - The Holderian comma (the approximate 9<sup>th</sup> of a Pythagorean tone, with 53 HCs – Holderian commas, see Fig. 3: 12 – to the octave), the cent, the mil (a tenth of a cent), etc., are measuring intervals.
  - For the semi-tonal scales (12-ET – 12 equal intervals to the octave), the semi-tone usually suffices as an interval of measurement, although in this particular case,<sup>282</sup> it is the tone that is taken as the reference interval (the semi-tone being half... of the tone).
- An *elementary interval* is a small interval used for composing other intervals: it may play no other role in the melody or the scale as the one of composing these other intervals. It is generally the smallest interval of the scale in ET-systems (Equal-Temperament scales), or one (or more) smallest intervals in uneven divisions of the scale:
  - The Pythagorean *comma* and the *leimma* by Urmawī (see Fig. 1: 11 and Fig. 22: 29), the quarter-tone in the quarter-tone model of Modal systematics, the semi-tone in the corresponding model, are elementary intervals used in the composition of other, greater intervals.
  - Additionally, the semi-tone in the semi-tone model of the scale, or the 17<sup>th</sup> of an octave in Urmawī's model, are also *conceptual intervals* (see next definition).
- A *conceptual interval* is one of the consecutive intervals of the second forming a musical system. For example, three seconds in a just fourth, four seconds in a just fifth, or seven seconds in an octave. Conceptual intervals can be measured either exactly or approximately with smaller intervals, usually of measurement, as in approximations using the quarter-tone or the HC:
  - In traditional heptatonic (Modal) musics, conceptual intervals follow rules and principles (see below). They have a guiding function for the melody, and establish a reference pattern for the performing musician. Their exact measure is secondary in relation to their role in the scale system (see Fig. 5: 14). Examples for conceptual intervals with Urmawī are provided in Fig. 1: 11 and Fig. 6: 16, and compared to other types of intervals used in systems (see *scale systems* below).
  - In theories of the scale which try to structure existing traditional musics, the concept for such intervals is indispensable in order to, for example, differentiate *generative* and *adaptive theories*, i.e. *prescriptive* or *descriptive theories*.
    - *Generative theories* use arithmetic and mathematics to model, sometimes reduced, scale structures independently from the existing structure of musics, and base themselves on axioms which are frequently biased.
    - *Adaptive theories* attempt to further adapt the generative procedure in order to better understand and explain existing musics. Modal systematics is typical of generative

<sup>281</sup> Note: appendices I, J and K are available for download at <http://nemo-online.org/articles>: they are not included in the printed or in-Volume version of the article.

<sup>282</sup> And others, such as for the quarter-tone model.

theories which adapt their axioms and sort the results in function of criteria stemming from existing musics.

- *Containing (or Container) intervals* such as the fourth, the fifth or the octave, include other intervals which compose them (see examples for the fourth containing interval in Fig. 23: 30 and Fig. 25: 38). *Container intervals* possess acoustic qualities which differentiate them from other intervals, and play the role of a guide in music performance:
  - Although *container intervals* play an important role in melody and scale formation other, mainly aesthetical or traditional criteria result in overriding this guidance role (see the Synthesis and footnotes nos. 268 and 269, p. 62 and p. 62 on *maqām Šabā*).

### Scale systems

Scale systems are defined as suites of conjunct intervals within a container element. These can be numerous, especially when the generative model is refined as is the case of the quarter-tone model (compared to the semi-tone model). A practical way of characterizing them is the systematic use of the *calibrated de-ranking process*, and their qualifications under *hyper- (scale) systems, systems and sub-systems*.

- The *regular* or *calibrated de-ranking process*, or *rotation process* (for octavial scales or for complete scalar systems only – see Fig. 8: 19), allows for an unambiguous generation and arrangement of scalar systems. It is based on regular repetitions of suites of conjunct intervals, generally within a *container interval* such as the fifth or the octave, and on successive rotations of the first interval in the scale system, which in each rotation is positioned after the last interval (and becomes the last interval – see Fig. 13: 21):
  - The *calibrated de-ranking process* has been used in music since at least the time of Aristoxenos (see Table 2: 9) for scale (*species*) generations. Modal systematics uses de-ranking as the basis for the classification and arrangement of scalar systems, including heptatonic octavial systems (see for example Fig. 16: 25 and Fig. 18: 25).

- For unambiguous classification of scales, such as with Modal systematics (Fig. 14: 21, Fig. 15: 22 and Fig. 17: 25), Modal systematics uses complementary definitions of scale elements, arranged as *hyper-systems, systems and sub-systems*:
  - Hyper-systems are capacity indicators for all systems and sub-systems they generate; themselves also a (head) system and (head) sub-system, they are picked out of the generation because the number resulting from their concatenation is minimal.
  - In Modal systematics arrangement of scale elements, hyper-systems generate, by a rotation process coupled with permutations, systems that are arranged in growing values of their concatenated intervals. The first system to be generated by the hyper-system (or head system) is the hyper-system itself.
  - Systems, in turn, generate sub-systems by a calibrated de-ranking process, each sub-system being given its rank through this procedure. The first sub-system to be generated by the system (or head sub-system) is the system itself.

### Concepts and rules

While the following principles and rules stem from traditional heptatonic music, and particularly from *maqām* music and the research of the author, they are also the result of common sense applied to heptatonic traditional musics in general.

- The *Principle of Memory* reflects the need for performers of traditional music to memorize the elementary scale divisions of the fourth (or archetypal tetrachords) in order to reproduce them effortlessly while performing. This applies equally (maybe even more) to Octavial scales, when the octave is the leading principle in a repertoire. In the latter case, scale species are so numerous that even in arranging (classifying) them in families of modal scales (such as in *maqām* musics) there is no practical way of memorizing them. In a traditional context, which generally includes improvisation, this is too much of a burden for musicians to carry in performance practice:

- The *Principle of Memory* explains why theories of the scale should not use too small elementary intervals, as this would introduce a quasi-impossibility for the existence of a traditional repertoire based on the memorization and identification of melodic patterns. It is illustrated for example in Fig. 34: 46 and Appendix A, where results of the generation of fourths in eighths of the tone are too numerous to be memorized by the common musician, even when tradition is based on Oral transmission (which implies a memorization process).
- The *Principle of Memory* complements the *principle of economy* and the *homogeneity rule* and reduces the theoretical complexity of scales based on very small elementary intervals which create, additionally, problems with the identification of *conceptual intervals* in performance practice.
- The *Principle of Economy*<sup>283</sup> complements the *principle of memory* in that, in music performance in traditional music as well as in theories for such musics, the infinite vertical continuum of pitches must be restricted to a certain number of melodic or structural archetypes that both musicians and auditors would be able to identify and memorize, without however reducing the expressivity of the performed music. The connection between the search for this equilibrium (between complexity and expressivity) and the internal *composition* of container intervals is straightforward, and constitutes the basis of Modal systematics:
  - for *maqām* music, which relies on subtle expressions of the melody, this optimum is reached within the general scale of 17 elementary intervals to the octave by Urmawī.<sup>284</sup> For western music (Common practice period), whose expressivity relies on the development of simultaneous vertical lines, it is the 12-intervals scale based on semitones which serves as a general scale.
  - for both *maqām* and semi-tonal musics, however, optimal expressivity following the *principle of economy* is reached with 3 intervals to the fourth, 4 intervals to the fifth, and 7 intervals to the octave (Part II).
- The *Homogeneity rule* helps *structuring* the intervals in a composed container element. In practical terms, the *Homogeneity rule* says that the sum of any two adjacent intervals in a scale system must be comprised between (and including) 6 and 8 quarter-tones, or, with ‘s’ being the sum of the two intervals,  $6 \leq s \leq 8$  (quarter-tones). This rule is also called the *Reverse pycnon rule* because the principle of *pycnidium*, as formulated by Aristoxenos, is the exact opposite to what we know about the internal structure of *maqām* music today (Fig. 30: 42):
  - The *Homogeneity rule* is nearly a perfect match<sup>285</sup> for modern *maqām* music. It allows for a particular generative process<sup>286</sup> which generates exclusively typical scale elements of the fourth and the fifth used in these musics (Fig. 28: 41, Fig. 29: 41 and Fig. 31: 43), as well as for expansions to the octave (Fig. 32: 44).
  - The homogeneity rule helps in particular understanding why an extension from the fourth to the fifth favors the existence of tones and semi-tones in the scale elements (Fig. 38: 49), to the detriment of the presence of zalzalian intervals in them.

\*  
\* \*

<sup>283</sup> See the corresponding section in Part II.

<sup>284</sup> Notwithstanding small intonational variations that would further embellish the performance (if the performer is talented), but play no role in the identification of the intervals used in melody or scales.

<sup>285</sup> Some very rare exceptions exist, as explained in the main text. These are not included, however, within the typical tetrachords of *maqām* musics.

<sup>286</sup> Which is, in this case, restricted to *maqām* musics.

## References

1. Anon. "Cairo Congress of Arab Music", *Wikipedia* [2016-10-10] [url: [https://en.wikipedia.org/w/index.php?title=Cairo\\_Congress\\_of\\_Arab\\_Music&oldid=743580485](https://en.wikipedia.org/w/index.php?title=Cairo_Congress_of_Arab_Music&oldid=743580485)].
2. Anon. "Duodecimal", *Wikipedia* [2017-1-14] [url: <https://en.wikipedia.org/w/index.php?title=Duodecimal&oldid=760017759>].
3. Anon. "Lawrence of Arabia (film)", *Wikipedia* [2016-12-11] [url: [https://en.wikipedia.org/w/index.php?title=Lawrence\\_of\\_Arabia\\_\(film\)&oldid=754142234](https://en.wikipedia.org/w/index.php?title=Lawrence_of_Arabia_(film)&oldid=754142234)].
4. ARISTOXENOS, (Aristoxène de Tarente) and Henry Stewart MACRAN: *Aristoxenoy Armonika stoicheia: The harmonics of Aristoxenus*, Oxford The Clarendon Press [Chicago - EU, 1902].
5. AZAR BEYHOM, Rosy: "La modalité écrite: un exemple avec Mikhā'il Mashāqa au XIX<sup>e</sup> siècle", *Near Eastern Musicology Online 1 1* [2012-11] [url: <http://nemo-online.org/wp-content/uploads/2016/12/INTERNET-05.-Article-NEMO-n%C2%B01-1-Rozy-Azar-Beyhom-Reissue-201612S.pdf>] p. 55–66.
6. BARBERA, André: "Octave Species", *The Journal of Musicology 3 3* [1984-7-1] [url: <http://www.jstor.org/stable/763813>] p. 229–241.
7. BARBERA, C. André: "Arithmetic and Geometric Divisions of the Tetrachord", *Journal of Music Theory 21 2* [1977-10-1] [doi: 10.2307/843492. url: <http://www.jstor.org/stable/843492>] p. 294–323.
8. BEYHOM, Amine: *1. Systématique modale – Volume I*, Thèse de doctorat, Université Paris Sorbonne [2003a-9-1] [url: <http://foredofico.org/CERMAA/publications/publications-on-the-site/publications-amine-beyhom>].
9. BEYHOM, Amine: *3. Systématique modale – Volume III*, Thèse de doctorat, Université Paris Sorbonne [2003b-9-3] [url: <http://foredofico.org/CERMAA/publications/publications-on-the-site/publications-amine-beyhom>].
10. BEYHOM, Amine: *Systématique modale – En 3 volumes*, PhD Thesis, Université Paris Sorbonne [2003c-9-17] [url: <http://www.sudoc.fr/075767538>, <http://foredofico.org/CERMAA/publications/publications-on-the-site/publications-amine-beyhom>].
11. BEYHOM, Amine: "Approche systématique de la musique arabe: genres et degrés système", *De la théorie à l'Art de l'improvisation: analyse de performances et modélisation musicale*, ed. Mondher Ayari, Delatour [Paris, 2005-12] [url: <http://foredofico.org/CERMAA/publications/publications-on-the-site/publications-amine-beyhom>] p. 65–114.
12. BEYHOM, Amine: "Une étude comparée sur les intervalles des musiques orientales", publ. internet [Royaumont – France, 2006-10-7] [url: [http://www.royaumont.com/fondation\\_abbaye/fileadmin/user\\_upload/dossier\\_PDF/programmes\\_musicaux/COLLOQUE\\_MAQAM\\_ET\\_CREATION\\_OCTOBRE\\_2005.pdf](http://www.royaumont.com/fondation_abbaye/fileadmin/user_upload/dossier_PDF/programmes_musicaux/COLLOQUE_MAQAM_ET_CREATION_OCTOBRE_2005.pdf)].
13. BEYHOM, Amine: "Dossier: Mesures d'intervalles – méthodologie et pratique", *Revue des Traditions Musicales des Mondes Arabe et Méditerranéen 1 1* [2007a-6] [url: <http://foredofico.org/CERMAA/publications/publications-on-the-site/publications-amine-beyhom>] p. 181–235.
14. BEYHOM, Amine: "Des Critères d'authenticité dans les musiques métissées et de leur validation: exemple de la musique arabe", *Filigrane. Musique, esthétique, sciences, société 5* [2007b-6] [url: <http://foredofico.org/CERMAA/publications/publications-on-the-site/publications-amine-beyhom>, URL: <http://revues.mshparisnord.org/filigrane/index.php?id=168>] p. 63–91.
15. BEYHOM, Amine: "Arabité et modernité en musique, ou de quel modèle se démarquer", *Congrès des musiques dans le monde de l'islam du 8 au 13 août 2007* [Assilah – Morocco, 2007c-8-8] [url: <http://www.mcm.asso.fr/site02/music-w-islam/articles/Beyhom-2007.pdf>, <http://www.mcm.asso.fr/site02/music-w-islam/congresfr.htm>, <http://www.mcm.asso.fr/site02/music-w-islam/intervenantsfr.htm>].
16. BEYHOM, Amine: "A new hypothesis on the elaboration of heptatonic scales and their origins", *ICONEA 2008*, Lulu on behalf of ICONEA PUBLICATIONS [London, 2010a] [url: <http://foredofico.org/CERMAA/publications/publications-on-the-site/publications-amine-beyhom>] p. 151–209.
17. BEYHOM, Amine: *Théories de l'échelle et pratiques mélodiques chez les Arabes – Volume 1: L'échelle générale et les genres – Tome 1: Théories gréco-arabes de Kindī (IX<sup>e</sup> siècle) à Ṭūsī (XIII<sup>e</sup> siècle) 1/4* (vols.), Librairie orientaliste Paul Geuthner [Paris, 2010b-11].
18. BEYHOM, Amine: "*Kashf al-Asrār 'an Karkarat al-Aḥbār fi Ta'wīl al-Adwār* كشف الأسرار عن كركرة الأحبار في تؤول الأوار", *Near Eastern Musicology Online 1 1* [2012-11] [url: <http://nemo-online.org/articles>] p. 67–88.
19. BEYHOM, Amine: "Un lexique de la modalité", *Near Eastern Musicology Online 2 2* [2013-11] [url: <http://nemo-online.org/articles>] p. 5–24.
20. BEYHOM, Amine: "Dossier: Influence des théories européennes du XIX<sup>e</sup> siècle sur la notation et la pratique des modes de la musique arabe et d'autres musiques, à travers la mise en exergue du mythe du genre *ḥijāz* semi-tonal", *Near Eastern Musicology Online 2 3* [2014-11] [url: <http://nemo-online.org/articles>] p. 87–177.
21. BEYHOM, Amine: *Théories et pratiques de l'échelle dans le chant byzantin arabe: Une approche comparative et analytique proposant une solution inédite pour le système théorique de Chrysanthos le Madyte*, Par l'auteur [Broummana (Liban), 2015a-9].
22. BEYHOM, Amine: *Théories de l'échelle et pratiques mélodiques chez les Arabes – Volume 1: L'échelle générale et les genres – Tome 1: Théories gréco-arabes de Kindī (IX<sup>e</sup> siècle) à Ṭūsī (XIII<sup>e</sup> siècle) 1/4* (vols.), Librairie orientaliste Paul Geuthner & l'Auteur (Electronic version) [Beyrouth, 2015b-11-25] [url: [http://foredofico.org/CERMAA/?attachment\\_id=482](http://foredofico.org/CERMAA/?attachment_id=482)].
23. BEYHOM, Amine: "Dossier: Hellenism as an Analytical tool for Occidentism (in musicology)", *Near Eastern Musicology Online 3 5* [2016-11] [url: <http://nemo-online.org/articles>] p. 53–273.
24. CHAILLEY, Jacques: "Essai sur les structures mélodiques", *Revue de Musicologie 44 120* [1959-12-1] [doi: 10.2307/927967. url: <http://www.jstor.org/stable/927967>] p. 139–175.
25. CHAILLEY, Jacques: *Éléments de philologie musicale [Recherche des principes - Intervalles et Échelles]*, Alphonse Leduc [Paris, 1985].
26. CHRAIBI, Said: *Souleimane*, CD [Morocco?, s.d.].
27. CHRAIBI, Said: *Taquassim Aoud*, CD [Morocco?, s.d.].
28. CLEONIDES: *L'Introduction Harmonique de Cléonide*, editor Charles-Emmanuel Ruelle [Paris, 1884].
29. COLLECTIF, ouvrage: *Recueil des Travaux du Congrès de Musique Arabe qui s'est tenu au Caire en 1932 (Hég. 1350) sous le Haut Patronage de S. M. FOUAD 1er, ROI D'ÉGYPTE*, Imprimerie Nationale d'Égypte [Le Caire - Égypte, 1934].
30. CROCKER, Richard L.: "Pythagorean Mathematics and Music", *The Journal of Aesthetics and Art Criticism 22 2* [1963-12-1] [doi: 10.2307/427754. url: <http://www.jstor.org/stable/427754>] p. 189–198.
31. CROCKER, Richard L.: "Pythagorean Mathematics and Music", *The Journal of Aesthetics and Art Criticism 22 3* [1964-4-1] [doi: 10.2307/427236. url: <http://www.jstor.org/stable/427236>] p. 325–335.

32. ERLANGER, Rodolphe (d'): *La musique arabe (5) – Essai de codification des règles usuelles de la musique arabe moderne. Échelle générale des sons, système modal 5/6* (vols.), Librairie Orientaliste Paul Geuthner |Paris, France, 1949].
33. FĀRĀBĪ (AL-), Abū-n-Naṣr Muḥammad ibn Muḥammad ibn Tarkhān: *La musique arabe (1) – Al-Fārābī, Grand traité de la musique [Kitāb al-Mūsīqī al-Kabīr] (Livres I et II)*, editor Rodolphe d'Erlanger, translator Rodolphe (d') Erlanger 1/6 (vols.), Librairie Orientaliste Paul Geuthner |Paris, France, 1930].
34. FĀRĀBĪ (AL-), Abū-n-Naṣr Muḥammad ibn Muḥammad ibn Tarkhān: *La musique arabe (1) – Al-Fārābī, Grand traité de la musique [Kitāb al-Mūsīqī al-Kabīr] (Livres I et II)*, editor Christian Poché, translator Rodolphe (d') Erlanger, ed. 2<sup>e</sup> en fac-similé, *Les Geuthner (Paris)*, ISSN 1294-6656 1/6 (vols.), Librairie Orientaliste Paul Geuthner |Paris, France, 2001].
35. FĀRĀBĪ (AL-), Abū-n-Naṣr Muḥammad ibn Muḥammad ibn Tarkhān, al-Ḥusayn ibn 'Abd-al-Lāh SĪNĀ (IBN) OU AVICENNE (0980?-1037), الحسين ابن عبد الله محمد ابن محمد أبو نصر الفارابي (1037?-0980) ابن سينا (1037: *La musique arabe (2) – Al-Fārābī [Grand traité de la musique] Livre III du Kitāb al-Mūsīqī al-Kabīr; Sīnā (ibn) ou Avicenne*, Kitāb a-sh-Shifā' – *Mathématiques*, editor Rodolphe d'Erlanger, translator Rodolphe (d') Erlanger, *Les Geuthner (Paris)*, ISSN 1294-6656 2/6 (vols.), Librairie Orientaliste Paul Geuthner |Paris, 1935].
36. FARMER, Henry George: "Greek Theorists of Music in Arabic Translation", *Isis* 13 2 |1930-2-1| [url: <http://www.jstor.org/stable/224649>] p. 325-333.
37. GIANNELOS, Dimitrios: *La musique byzantine: le chant ecclésiastique grec, sa notation et sa pratique actuelle*, Collection Musique et musicologie, les Dialogues, ISSN 1272-1972; 1996, L'Harmattan |1996].
38. HELMHOLTZ, Hermann L. F. (von): *On the sensations of tone as a physiological basis for the theory of music: Translated, rev. and corr. rendered conformable to the 4<sup>th</sup> (and last) German ed. of 1877*, Longmans, Green, and Co. |London, UK, 1895].
39. MATHIESEN, Thomas J: *Apollo's lyre: Greek music and music theory in antiquity and the Middle Ages*, University of Nebraska Press |Nebraska - EU, 1999].
40. NELSON, David Lowell: *An Analysis of Olivier Messiaen's Chant Paraphrases in two volumes*, Ph.D., university of Evanston |Evanston, Illinois, United-States, 1992].
41. POWERS, Harold S. and Richard WIDDESS: "India, §III, 1: Theory and practice of classical music: Tonal systems in Oxford Music Online", *Grove Music Online* [2001] [url: <http://www.oxfordmusiconline.com/>].
42. POWERS, Harold S., Frans WIERING, James PORTER, et al. : "Mode", *The New Grove Dictionary of Music and Musicians* 16/29 (vols.), Oxford University Press |Oxford, 2001].
43. ṢABBĀGH (A-Ṣ-), Tuwfiq ḥāḍir: *الأستاذ توفيق الصباغ: الدليل الموسيقي العام في أطرب الأناغم مطبعة الإحسان A-d-Dalil al-Mūsīqī al-Ām fi Aṭrab al-Anghām*, مطبعة الإحسان لمينم الزوم الكتوليك Maṭba'at al-Iḥsān li-Maytam a-r-Rūm al-Kāthūlik |Aleppo, 1950].
44. SCHULTER, Margo: "Systematist Buzurg and its Relatives: Notes on a Zalzalian Modal Genre", *Near Eastern Musicology Online* 2 2 |2013-11| [url: <http://nemo-online.org/articles>] p. 25-49.
45. SIGNELL, K. : "Contemporary Turkish makam practice", *Garland Encyclopedia of World Music* 6 |2002| p. 47-58.
46. SĪNĀ (IBN) OU AVICENNE (0980?-1037): "Kitāb] a-sh-Shifā' - Riyādiyyāt 3 - Jawāmi' 'Ilm al-Mūsīqā", Wizārat a-t-Tarbiya wa-t-Ta'lim, Al-Maṭba'a al-Amiriyya |Cairo, 1956].
47. URMĀWĪ (D. 1294), Ṣafīyy-a-d-Dīn 'Abd-al-Mu'mīn ibn Yūsuf ibn (ab-ī-l-Ma)Fākhīr (al-) Ṣafī al-aramūi and 'Alī ibn Muḥammad [JURJĀNĪ (AL-)]: *La musique arabe (3) – I. A-sh-Sharafiyya ou Ēpître à Sharaf a-d-Dīn. II. (Commentaire anonyme du) Kitāb al-Adwār ou Livre des Cycles musicaux*, translator Rodolphe (d') Erlanger, ed. orig., *La Musique Arabe* 3/6 (vols.), Librairie Orientaliste Paul Geuthner |Paris, 1938].
48. WRIGHT, Owen: *The modal system of Arab and Persian music, 1250-1300: an interpretation of contemporary texts.* |1969].

