



HAL
open science

Biaxial testing of Knitted NiTi textiles: adapted image processing vs DIC

Nathanaël Connesson, François Tissot, Denis Favier, Ludek Heller

► **To cite this version:**

Nathanaël Connesson, François Tissot, Denis Favier, Ludek Heller. Biaxial testing of Knitted NiTi textiles: adapted image processing vs DIC. Photomechanics 2015, May 2015, Delf, Netherlands. hal-02006098

HAL Id: hal-02006098

<https://hal.science/hal-02006098>

Submitted on 4 Feb 2019

HAL is a multi-disciplinary open access archive for the deposit and dissemination of scientific research documents, whether they are published or not. The documents may come from teaching and research institutions in France or abroad, or from public or private research centers.

L'archive ouverte pluridisciplinaire **HAL**, est destinée au dépôt et à la diffusion de documents scientifiques de niveau recherche, publiés ou non, émanant des établissements d'enseignement et de recherche français ou étrangers, des laboratoires publics ou privés.

Biaxial Testing of Knitted NiTi Textiles: DIC VS Adapted Image Processing

N. Connesson^{*}, F. Tissot[†], D. Favier^{*}, L. Heller[‡]

[‡]Institute of Physics, Prague, Czech Republic

^{*}Laboratoire TIMC, Grenoble, France



Introduction

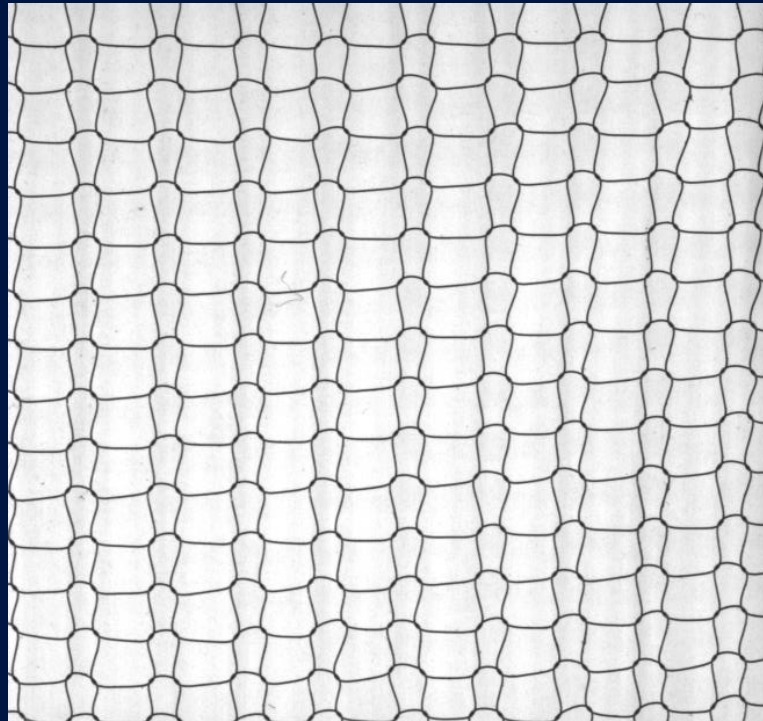

L. Heller, [‡]Institute of Physics, Prague, Czech Republic

NiTi Knitted textile (ϕ 100 μm)

Introduction

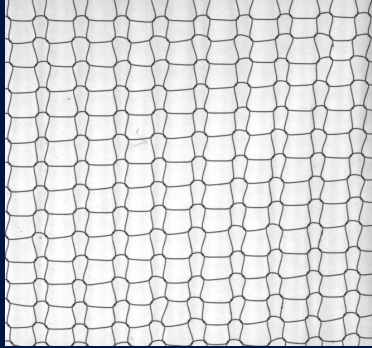

NiTi Knitted textile (ϕ 100 μm)

L. Heller, ^{*}Institute of Physics, Prague, Czech Republic

Mechanical behaviour

???

Biaxial testing

Introduction

Biaxial testing

Camera

Grips and
Force transducer

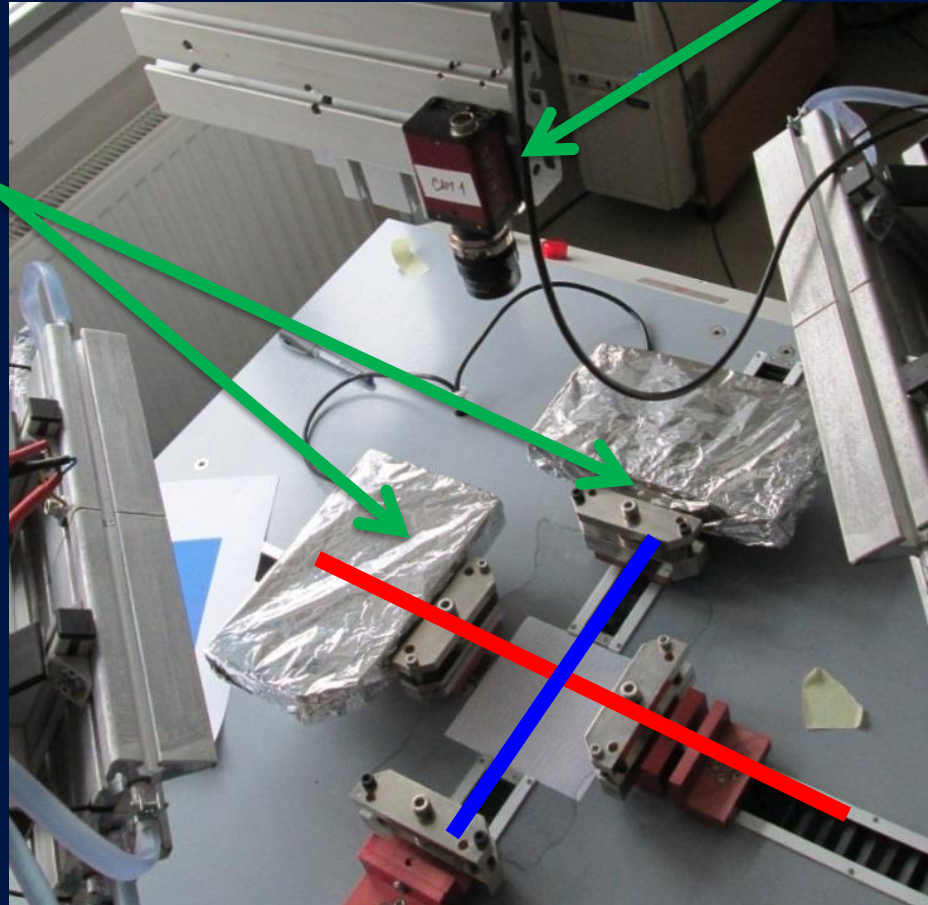

Introduction

Biaxial testing

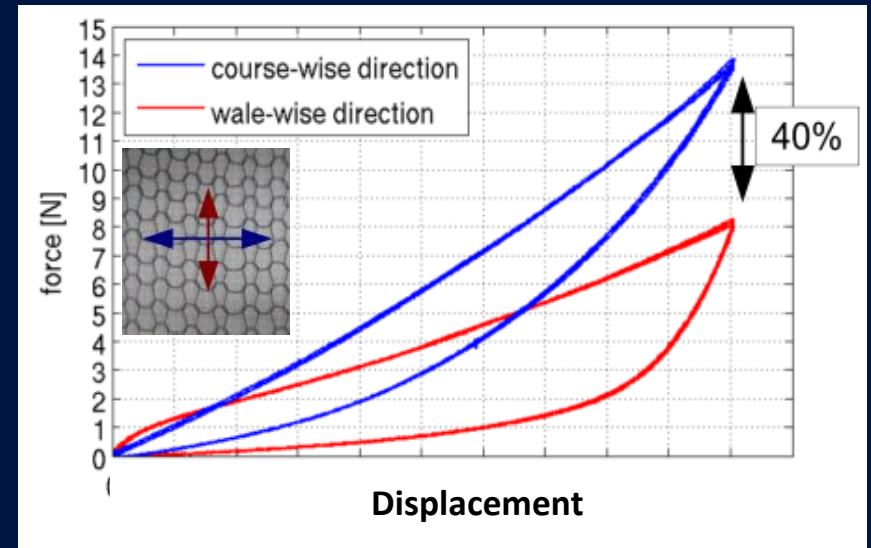
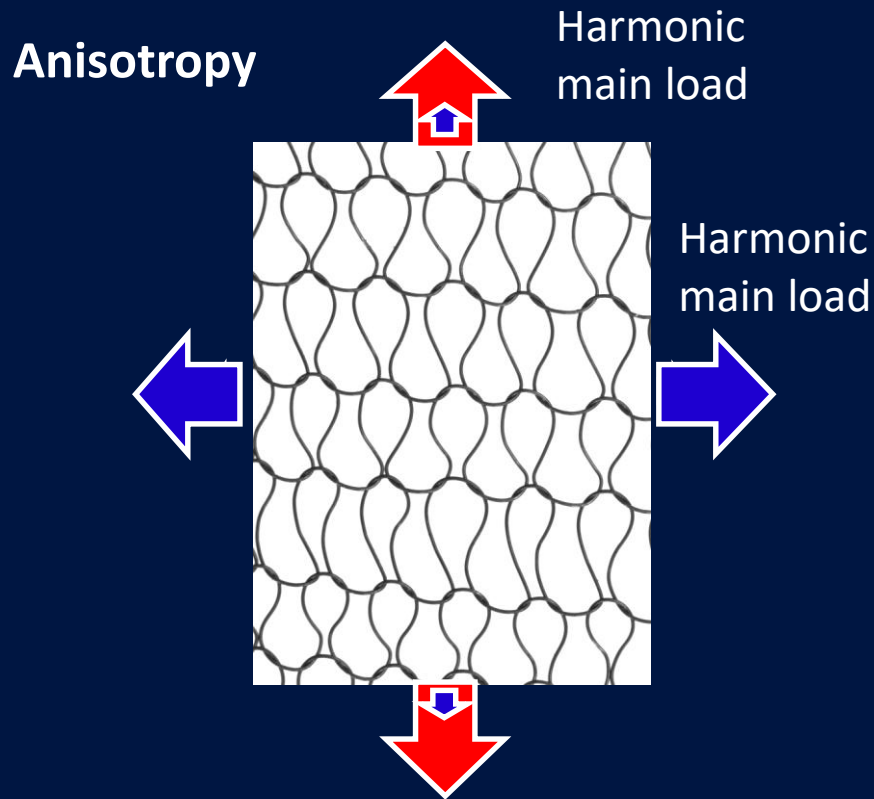

Extract data from the pictures ...

Introduction

Data we would like to extract :

- Displacement fields
=> Strain fields
- And... :
 - Geometria of wire/loops
 - Gliding => energy dissipation by friction

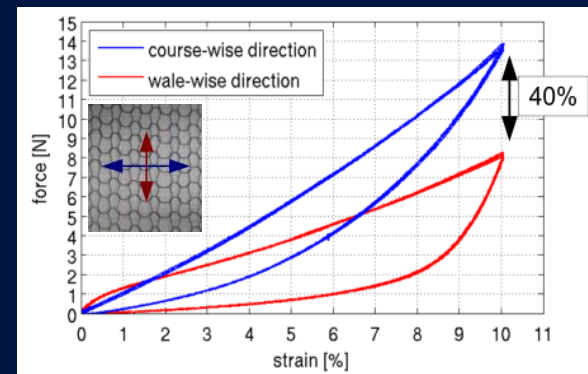
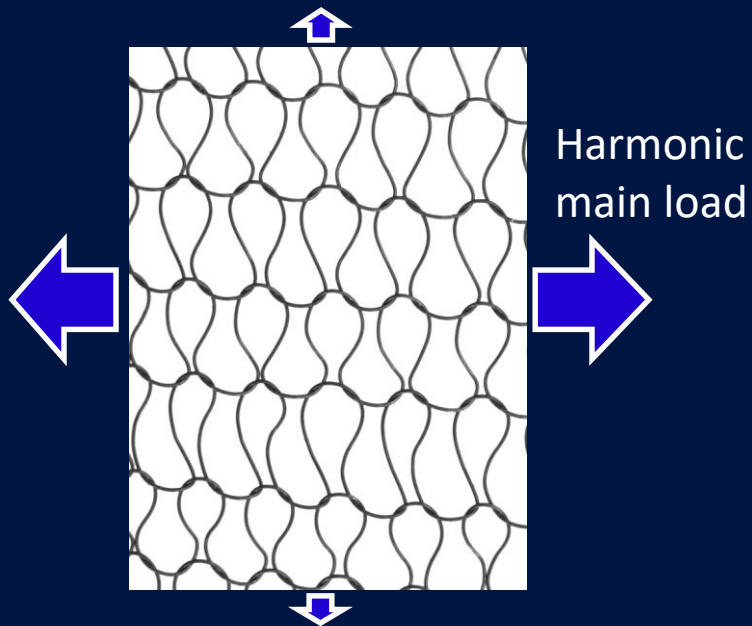

Introduction

How to extract these data ?

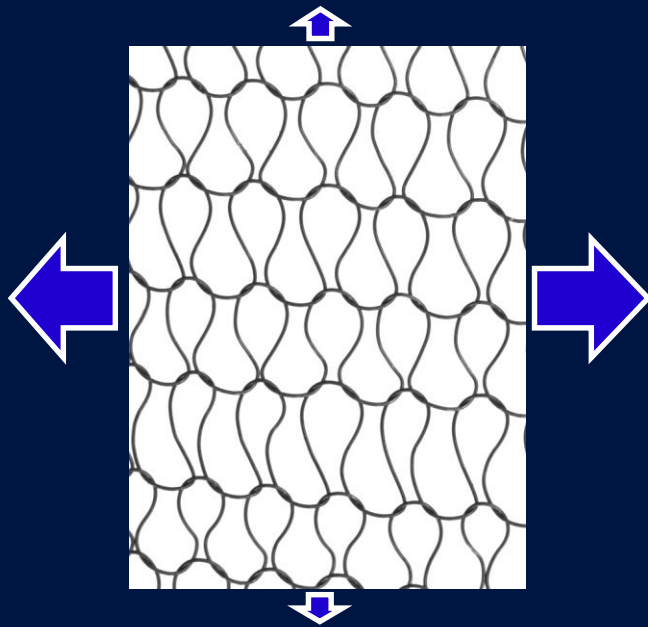

- Displacement fields / Strain fields
- Geometria of wire/loops
- Gliding => energy dissipation by friction

DIC VS Adapted Image Processing

Outline

Introduction

I. DIC

II. Data Processing

a) Displacements fields

b) Shape and gliding

Conclusion

Outline

Introduction

I. DIC

II. Data Processing

a) Displacements fields

b) Shape and gliding

Conclusion

I. DIC

- Displacement fields / Strain fields
- Geometria of wire/loops
- Gliding => energy dissipation by friction

2D Digital Image Correlation (Vic 2D)

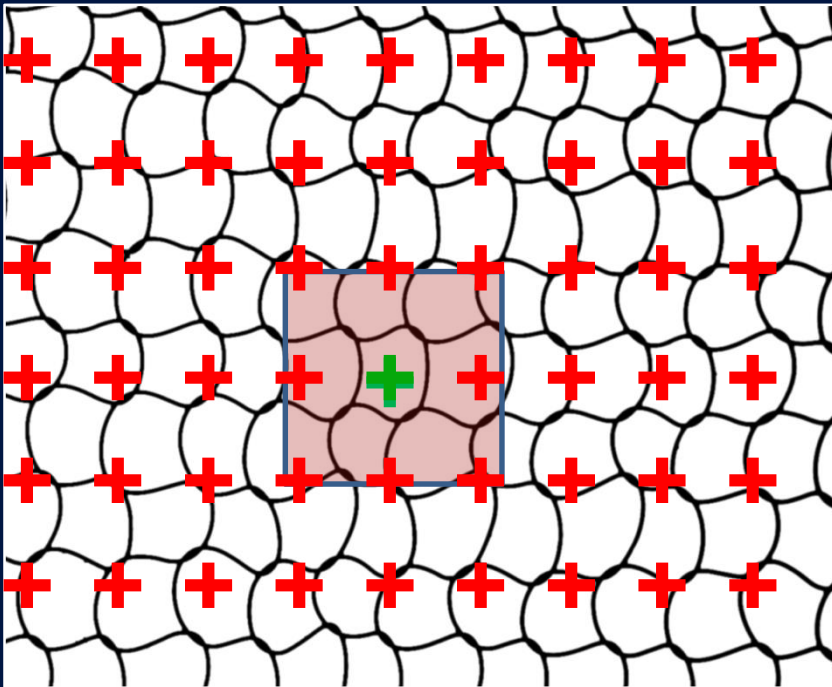

Not an optimal speckle...

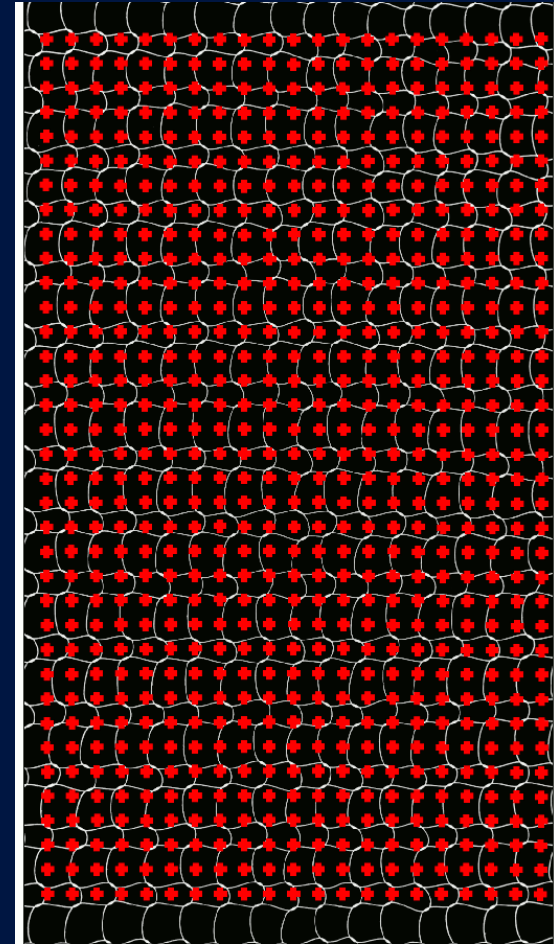

Immaterial points tracking => lack physical meaning ☹️

I. DIC

Can we do better ?

Well, yes !

Outline

Introduction

I. DIC

II. Data Processing

a) Displacement fields

b) Shape and gliding

Conclusion

II. Data Processing

a) Displacement fields

Loop center identification
(Bwlabel, Matlab)

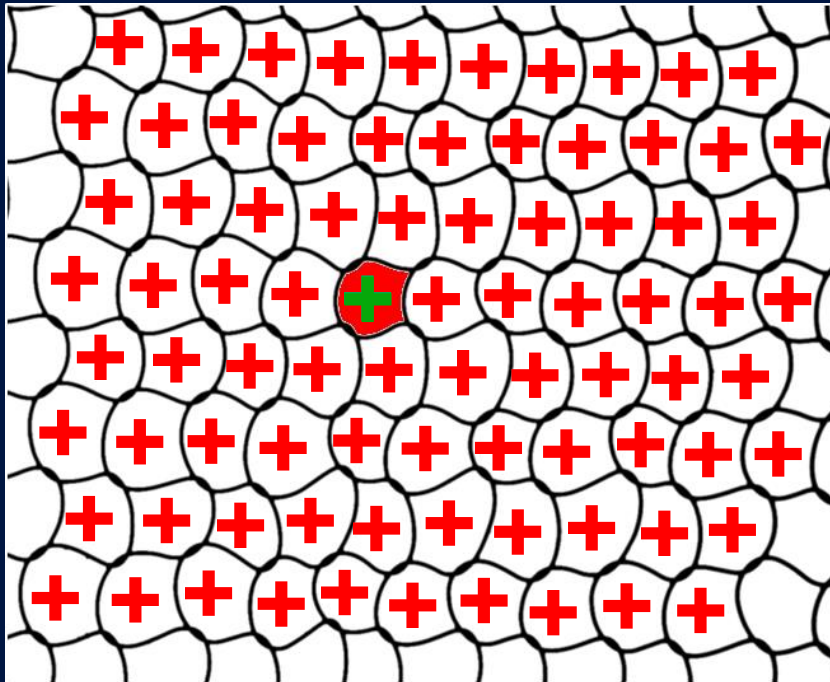

Loop center
=> more physical meaning 😊

- Displacement fields / Strain fields
- Geometria of wire/loops
- Gliding => energy dissipation by friction

Knitted structure

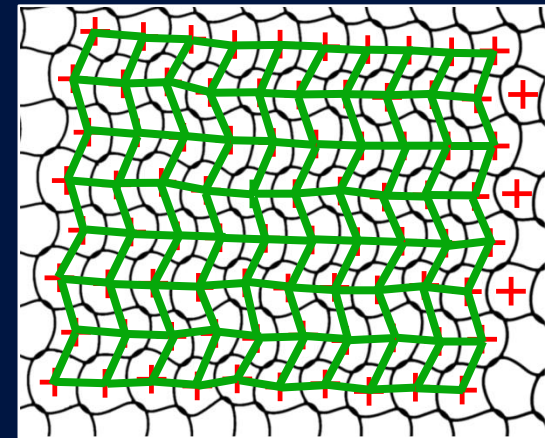

Time tracking

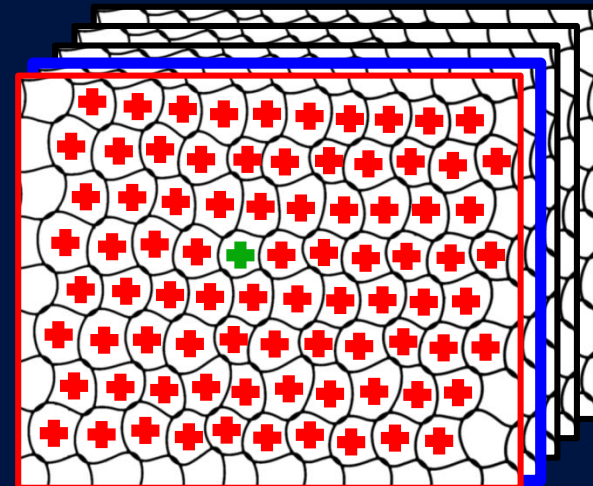

II. Data Processing

a) Displacement fields

- Displacement fields / Strain fields
- Geometria of wire/loops
- Gliding => energy dissipation by friction

Time tracking (Bwlabel, Matlab)

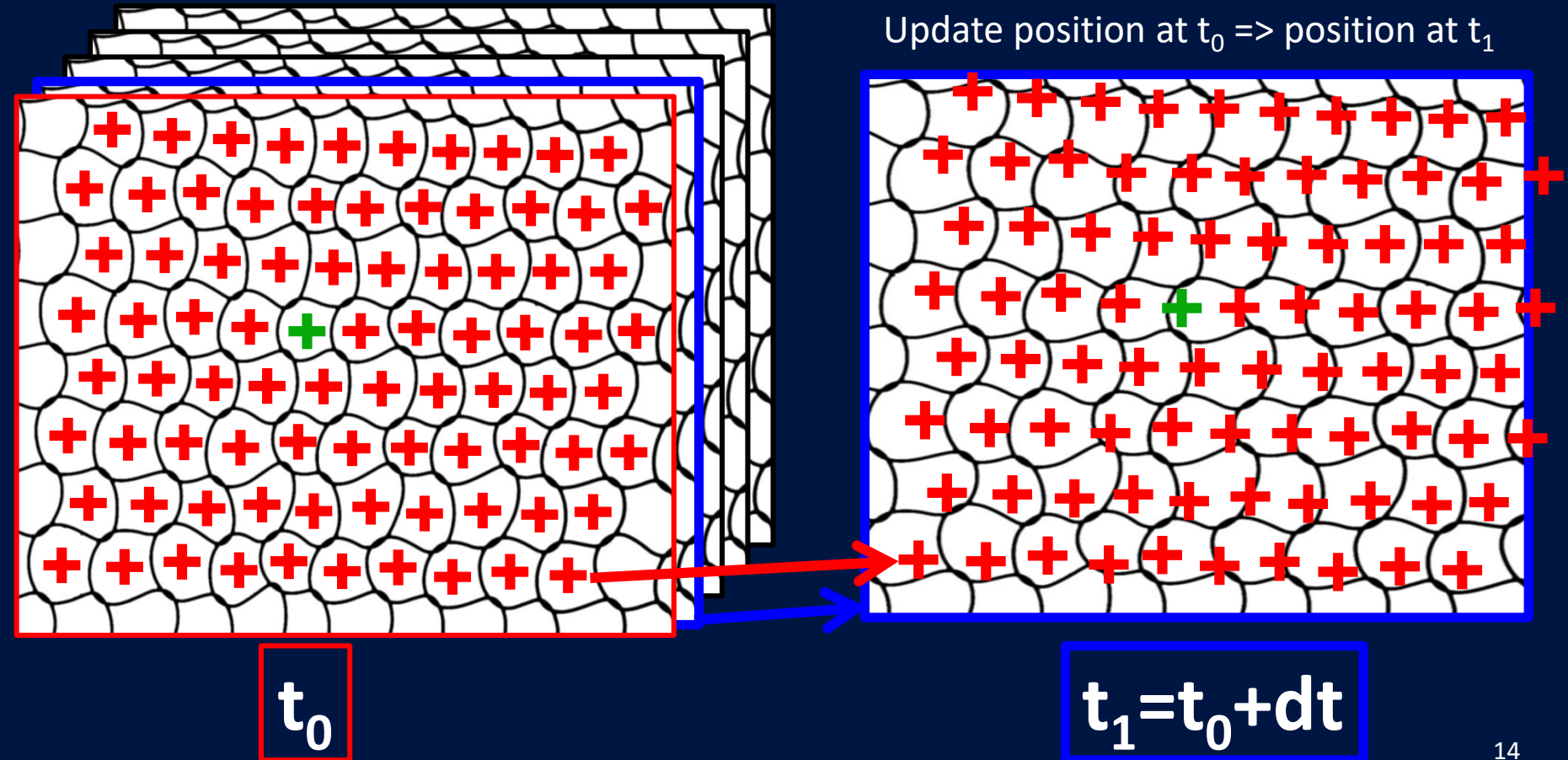

II. Data Processing

a) Displacement fields

- Displacement fields / Strain fields
- Geometria of wire/loops
- Gliding => energy dissipation by friction

Time tracking (Bwlabel, Matlab)

Update position at $t_0 \Rightarrow$ position at t_1

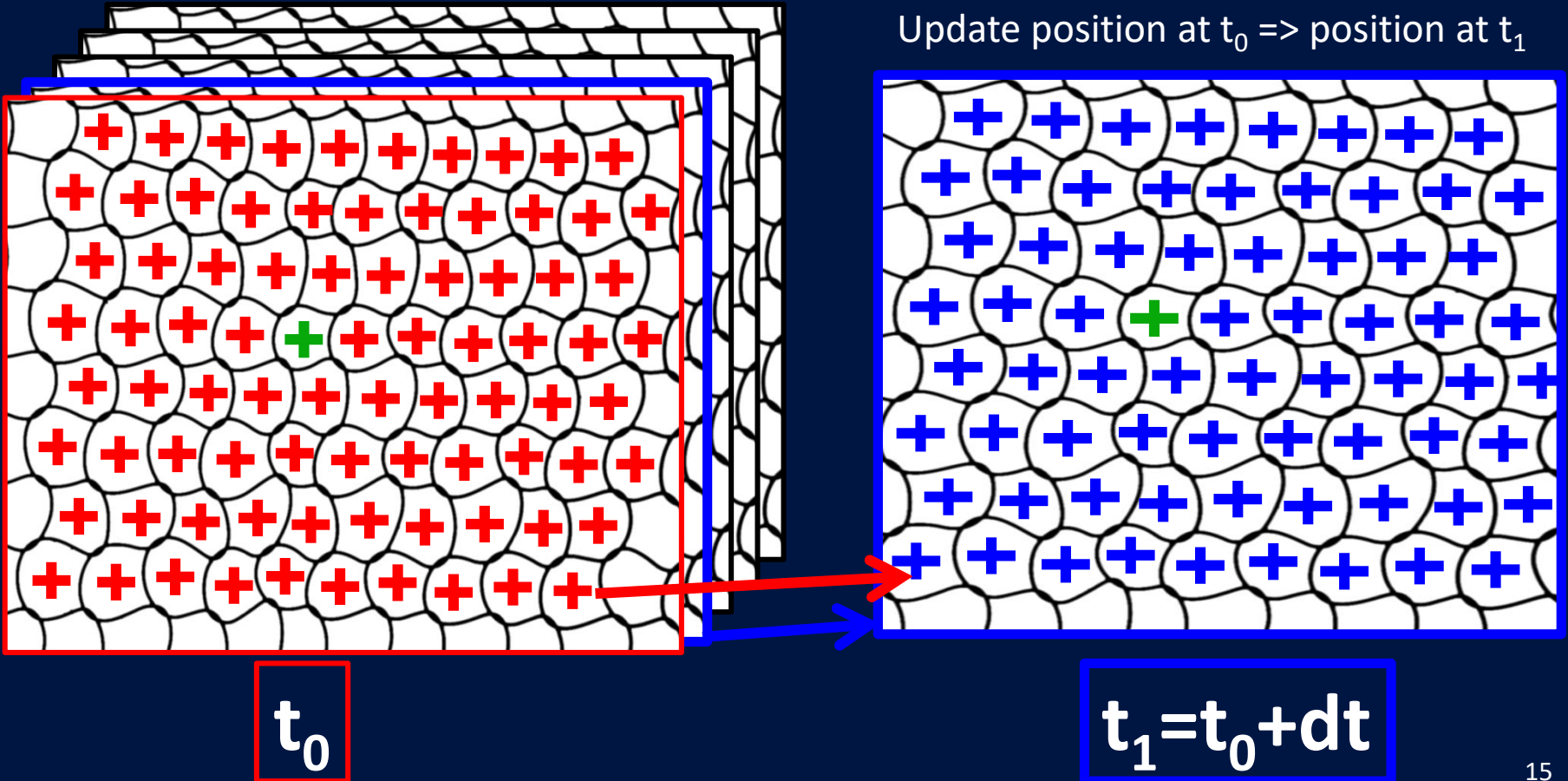

II. Data Processing

a) Displacement fields

- Displacement fields / Strain fields
- Geometria of wire/loops
- Gliding => energy dissipation by friction

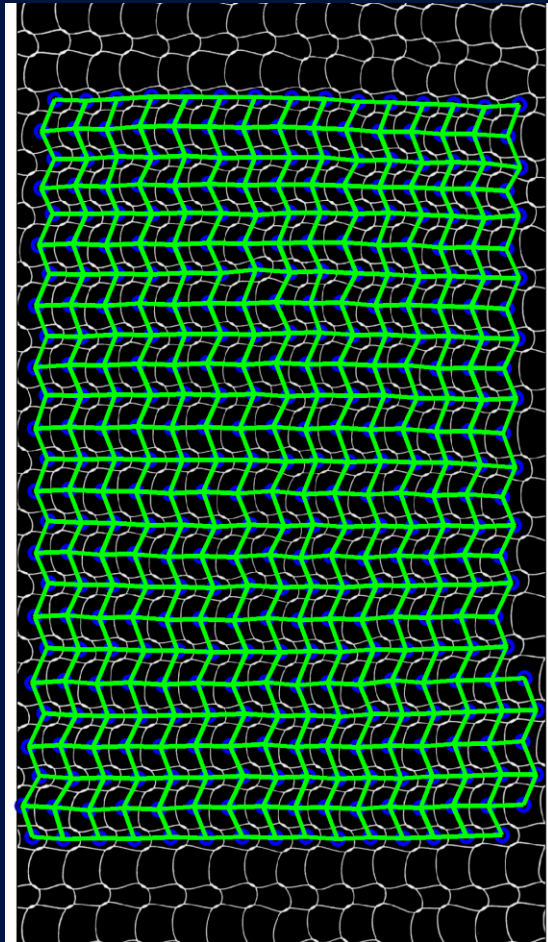

Home made data processing

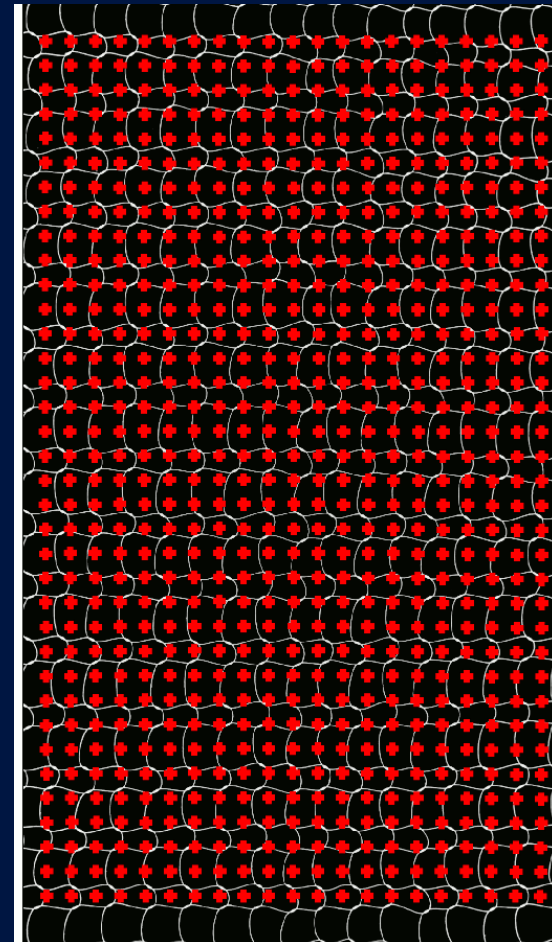

DIC (Vic 2009)

II. Data Processing

We extracted :

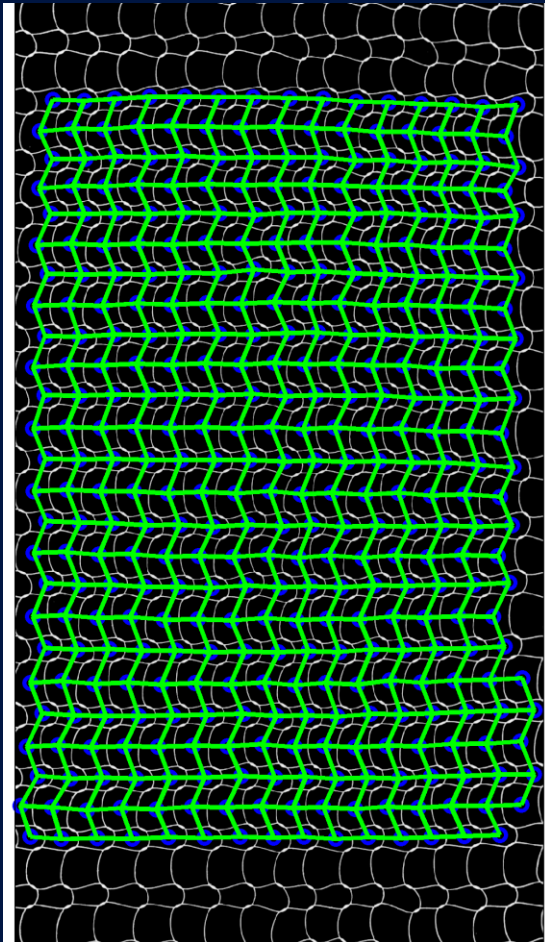

- Displacement fields / Strain fields
- Geometria of wire/loops
- Gliding => energy dissipation by friction

Outline

Introduction

I. DIC

II. Data Processing

a) Displacement fields

b) Shape and gliding

Conclusion

II. Data Processing

b) Shape and gliding

- Displacement fields / Strain fields
- Geometria of wire/loops
- Gliding => energy dissipation by friction

Spoiler :

II. Data Processing

b) Shape and gliding

- Displacement fields / Strain fields
- Geometria of wire/loops
- Gliding => energy dissipation by friction

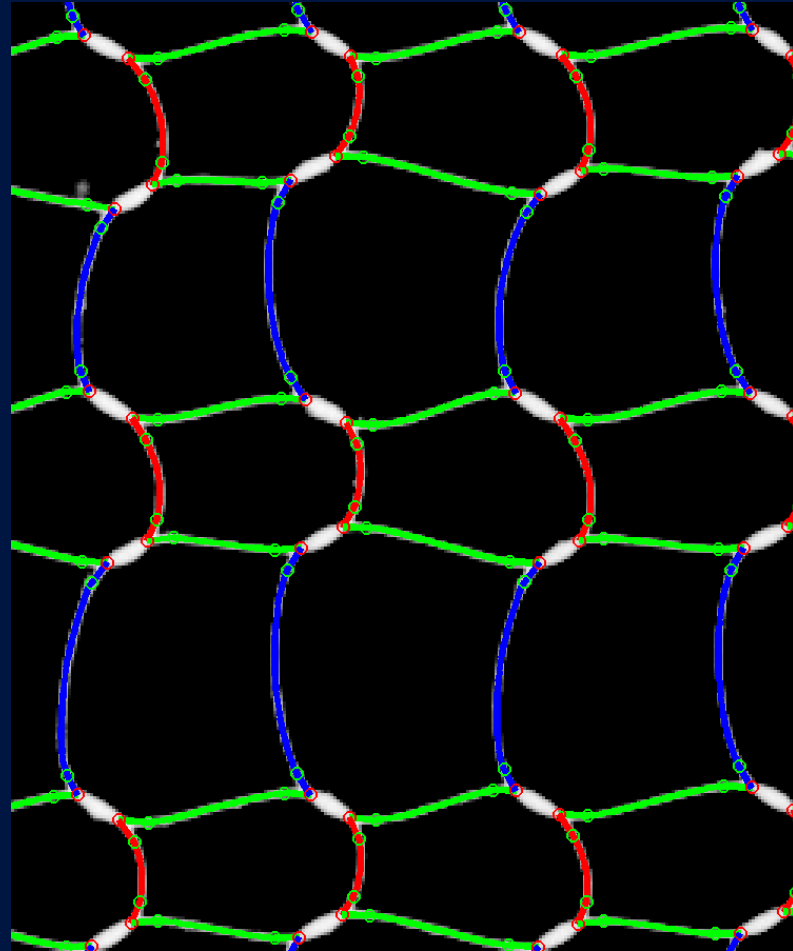
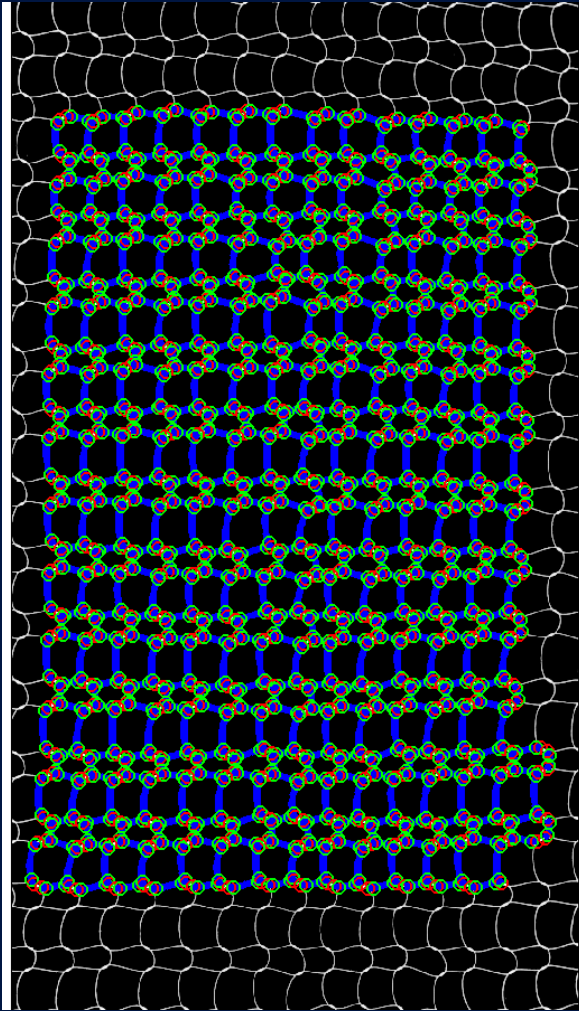

II. Data Processing

b) Shape and gliding

- Displacement fields / Strain fields
- Geometria of wire/loops
- Gliding => energy dissipation by friction

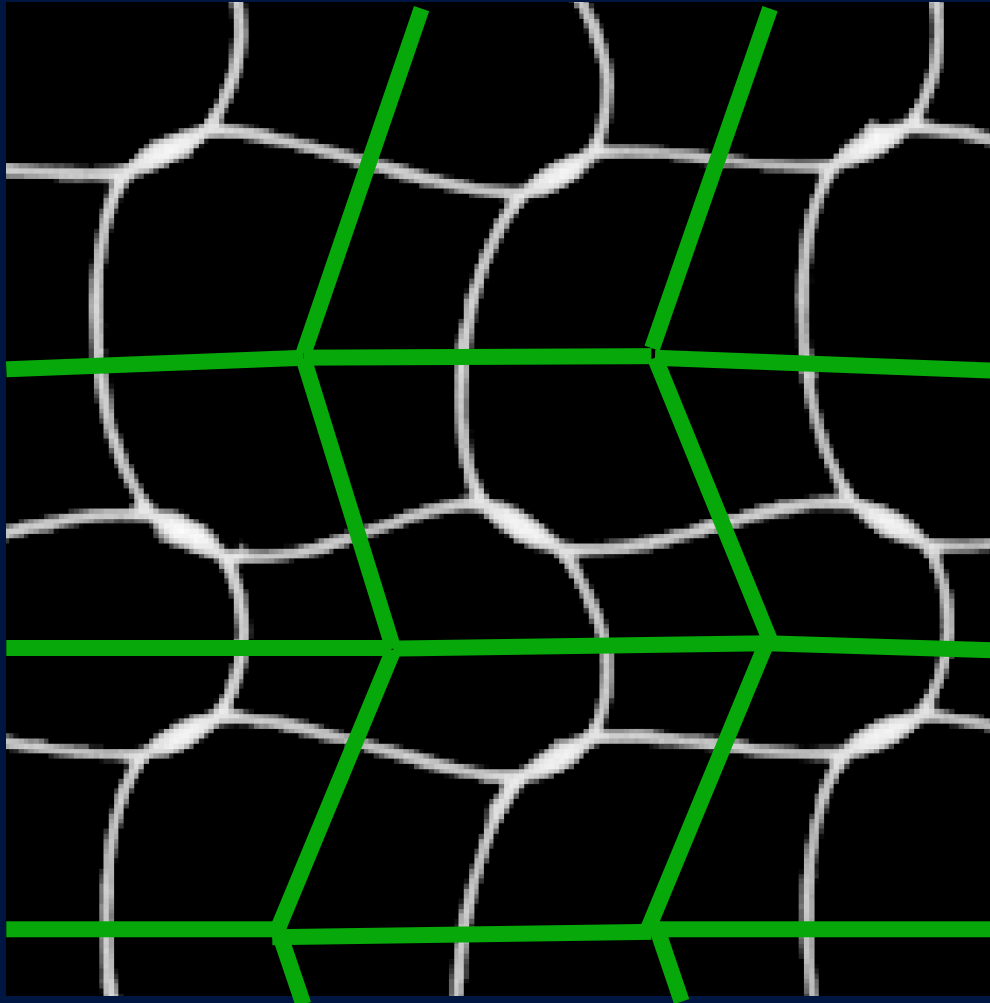

Bwlabel

II. Data Processing

b) Shape and gliding

- Displacement fields / Strain fields
- Geometria of wire/loops
- Gliding => energy dissipation by friction

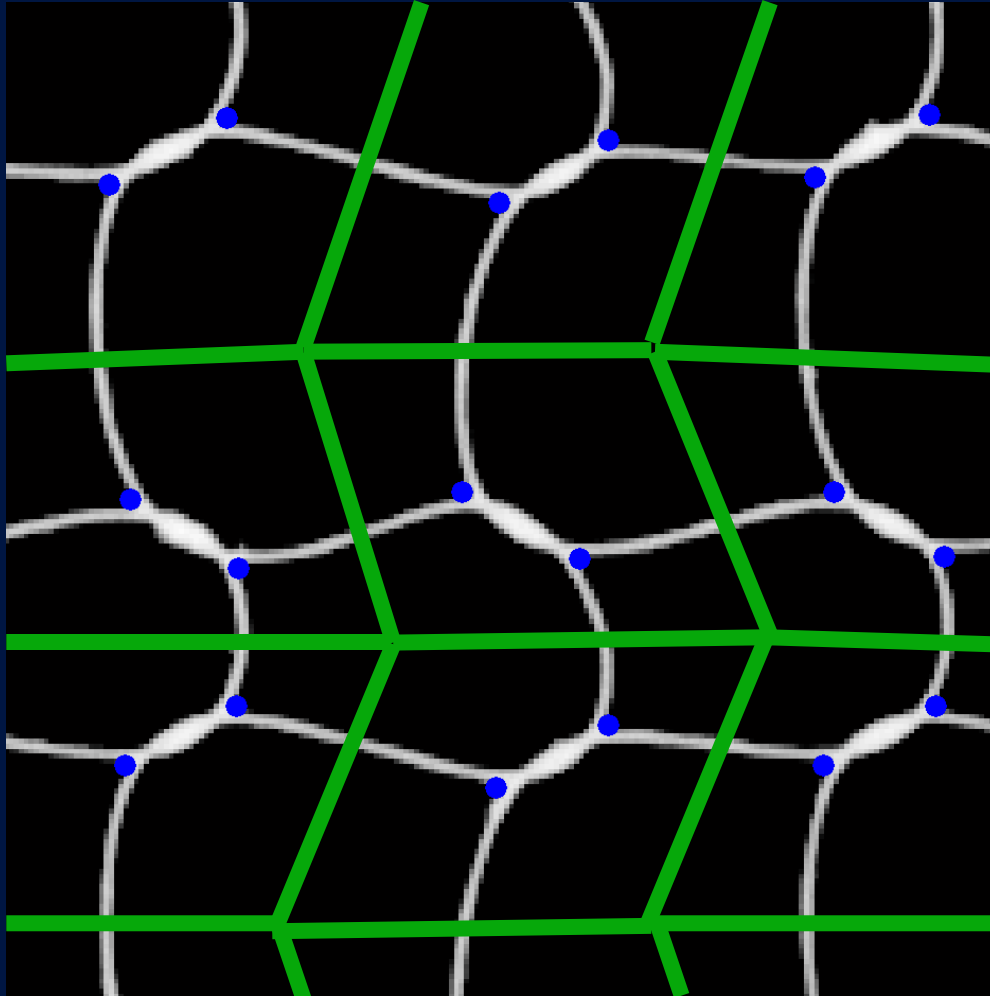

Bwlabel

Bwperim

II. Data Processing

b) Shape and gliding

- Displacement fields / Strain fields
- Geometria of wire/loops
- Gliding => energy dissipation by friction

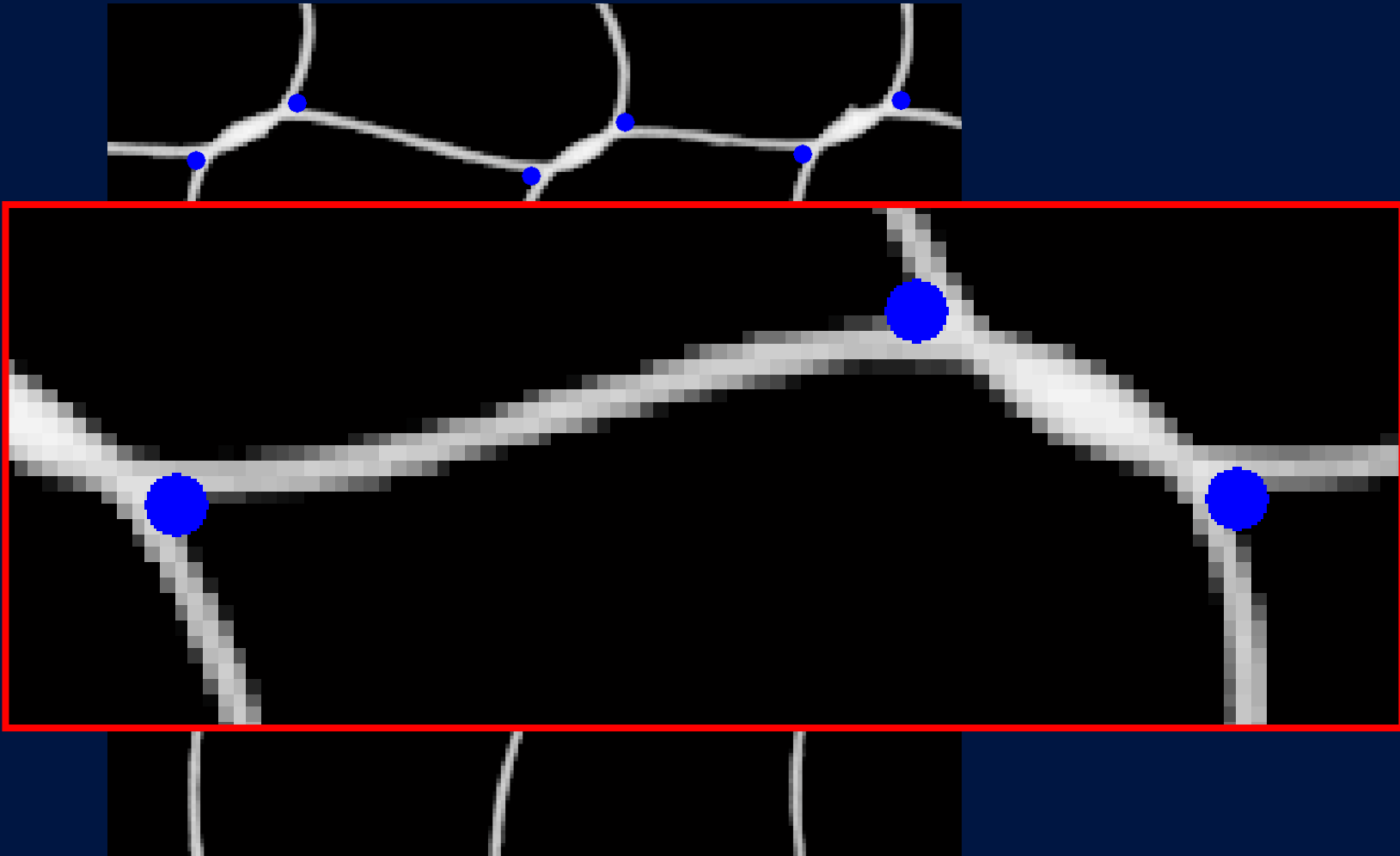

II. Data Processing

b) Shape and gliding

- Displacement fields / Strain fields
- Geometria of wire/loops
- Gliding => energy dissipation by friction

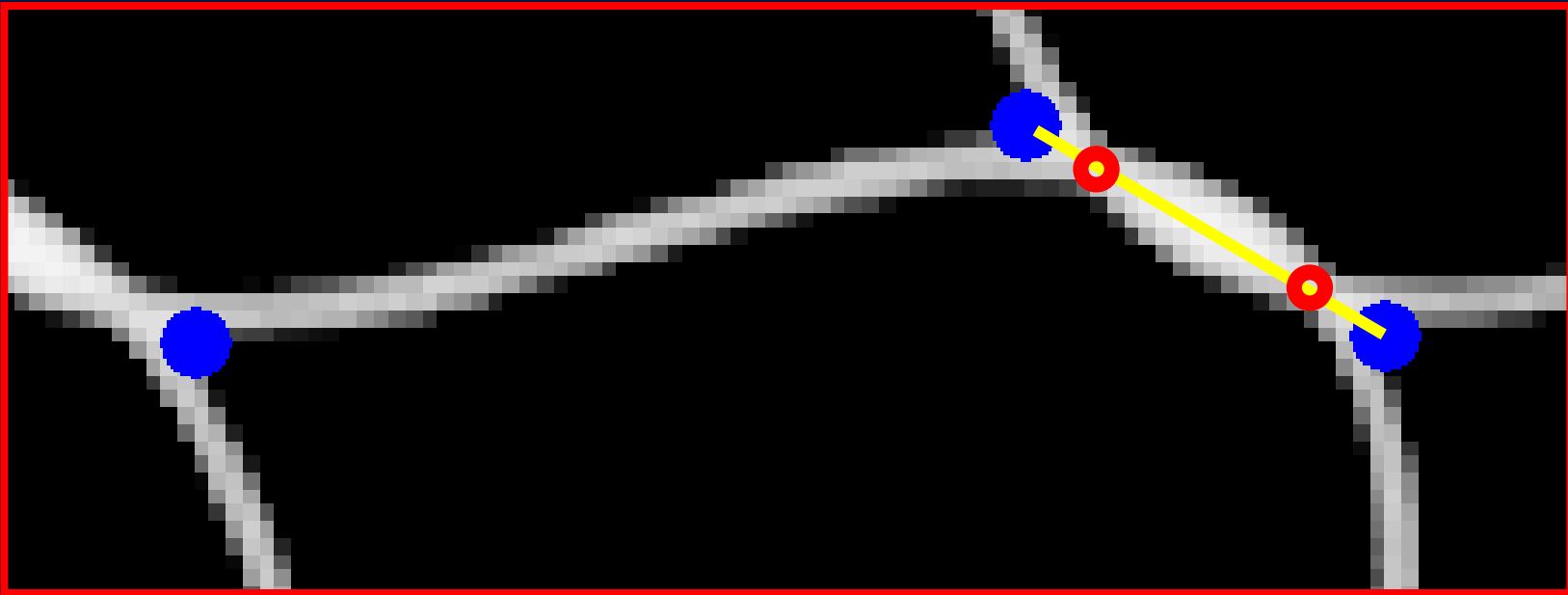

II. Data Processing

b) Shape and gliding

- Displacement fields / Strain fields
- Geometria of wire/loops
- Gliding => energy dissipation by friction

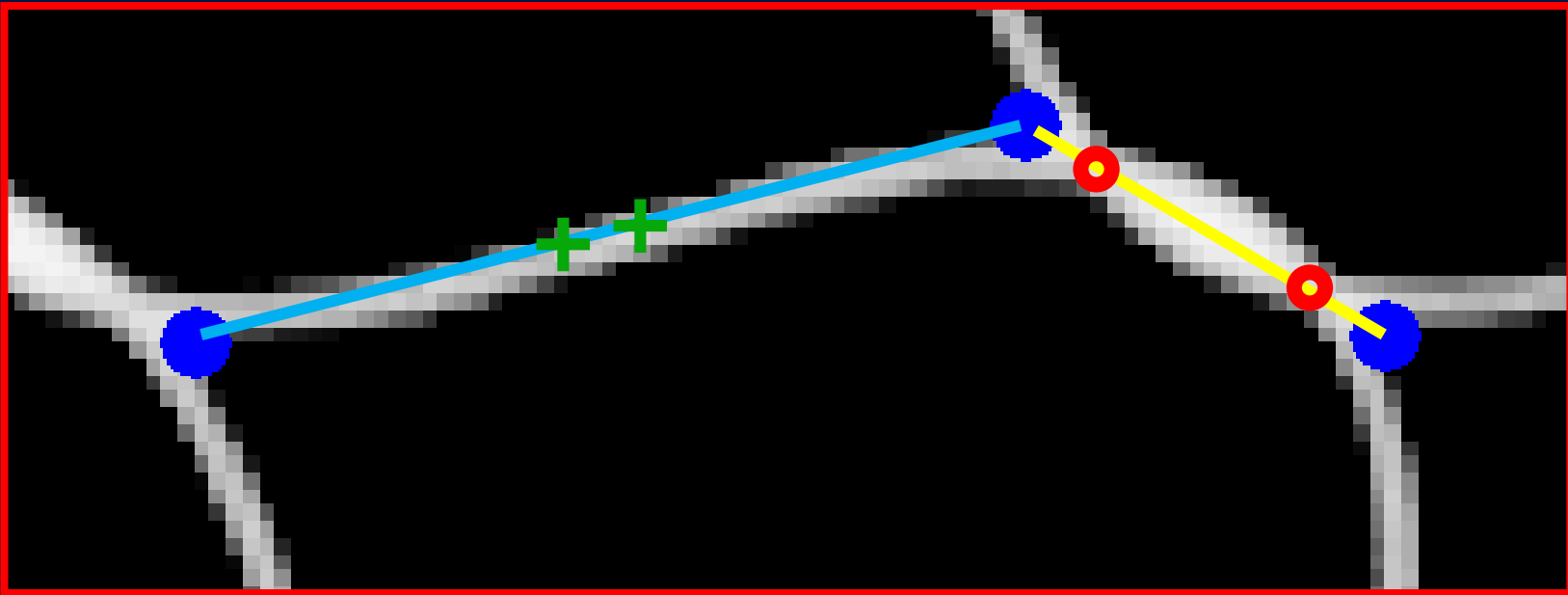

II. Data Processing

b) Shape and gliding

- Displacement fields / Strain fields
- Geometria of wire/loops
- Gliding => energy dissipation by friction

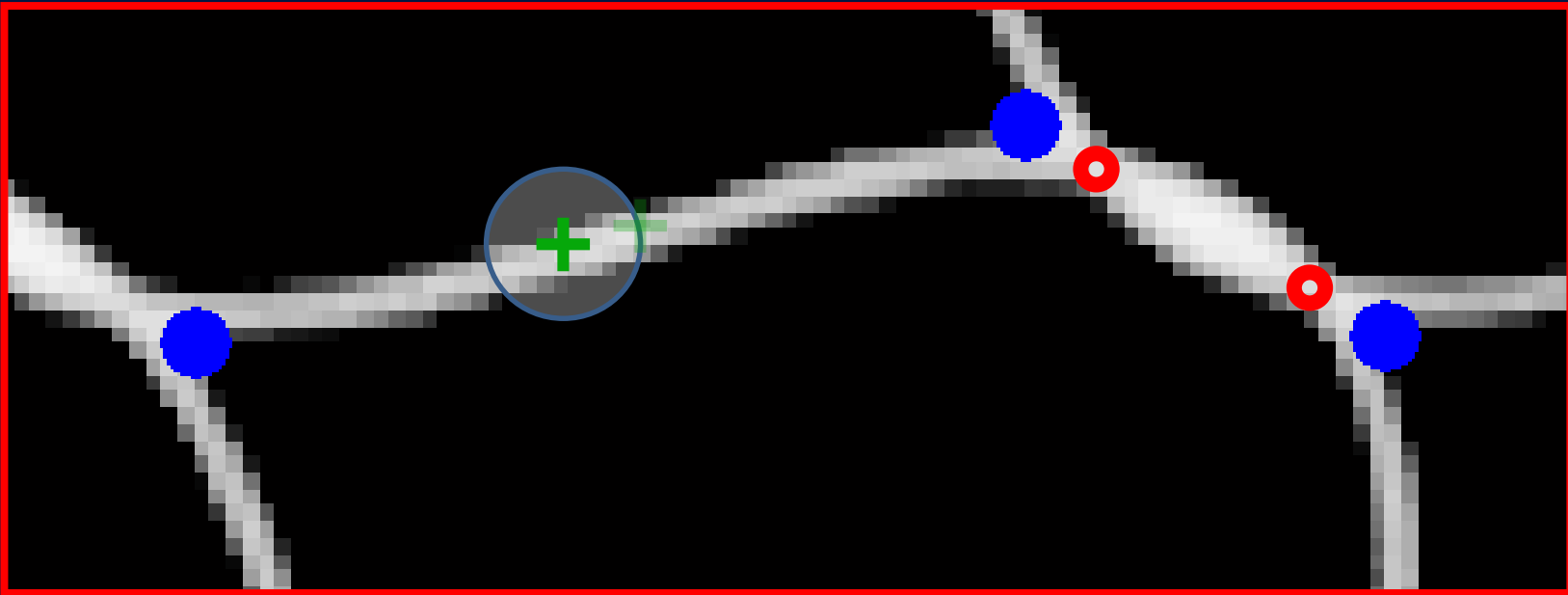

II. Data Processing

b) Shape and gliding

- Displacement fields / Strain fields
- Geometria of wire/loops
- Gliding => energy dissipation by friction

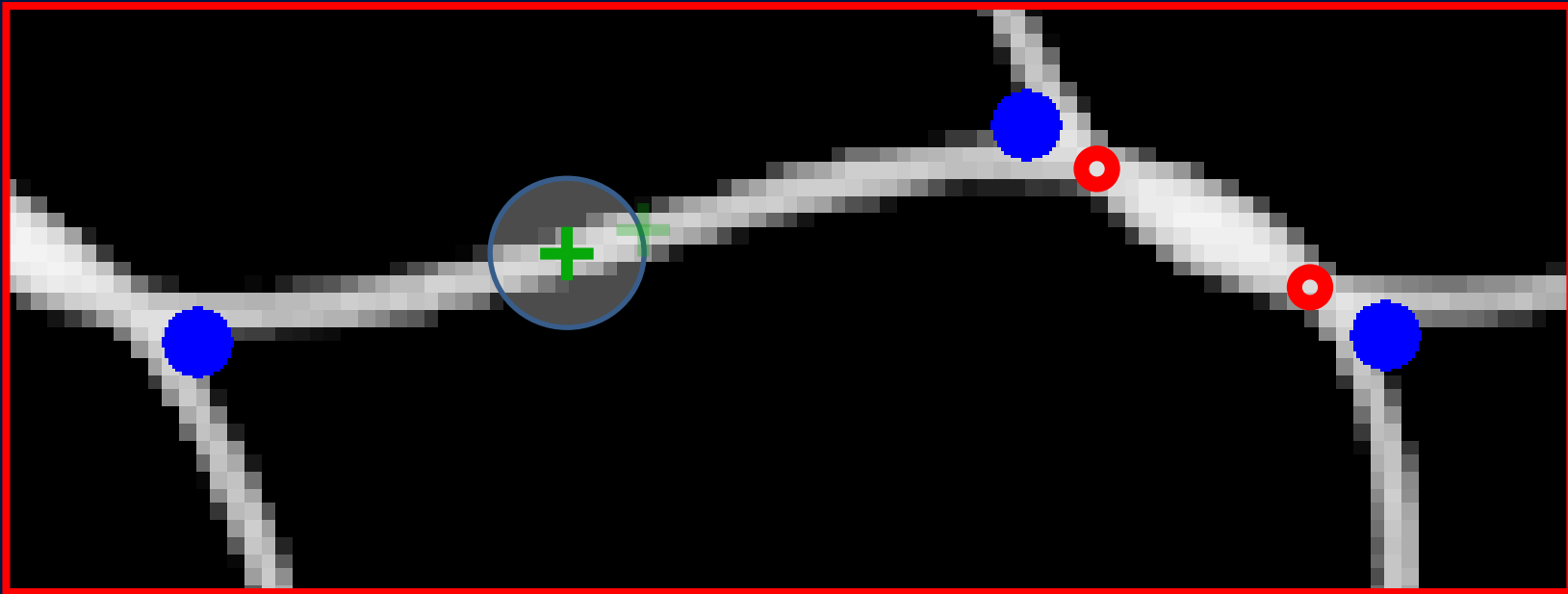

II. Data Processing

b) Shape and gliding

- Displacement fields / Strain fields
- Geometria of wire/loops
- Gliding => energy dissipation by friction

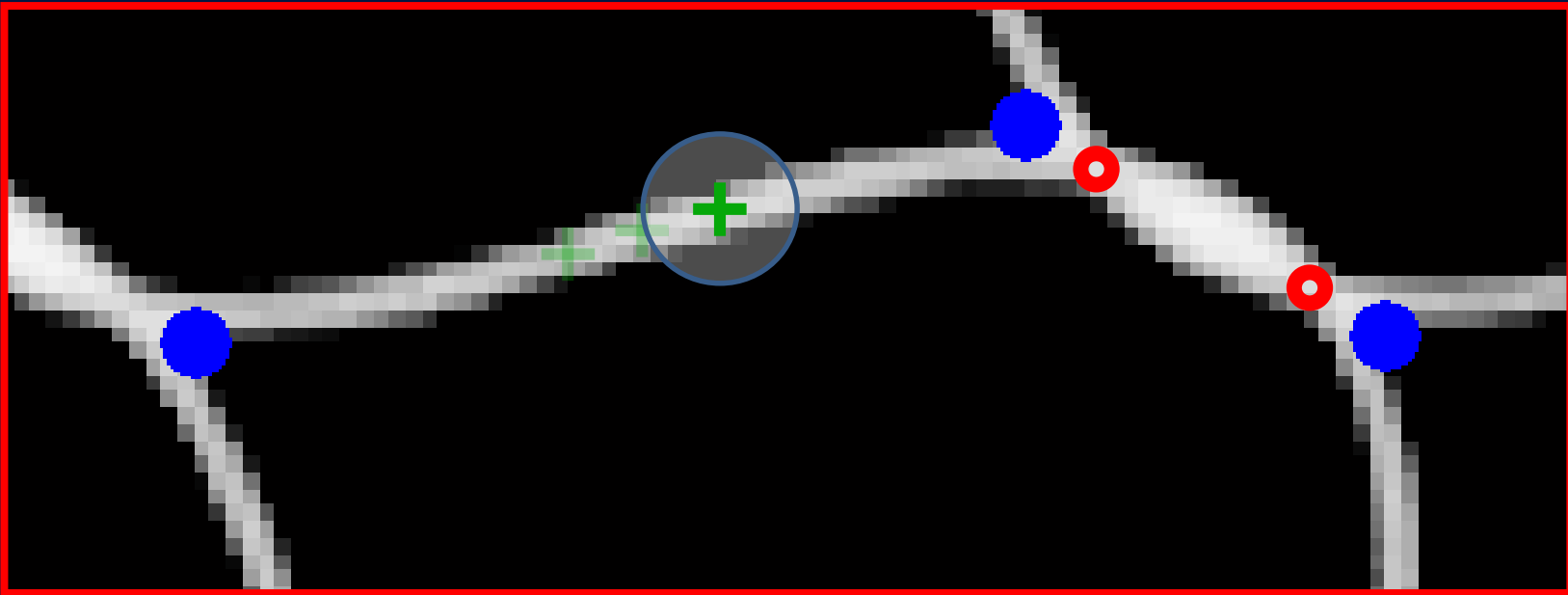

II. Data Processing

b) Shape and gliding

- Displacement fields / Strain fields
- Geometria of wire/loops
- Gliding => energy dissipation by friction

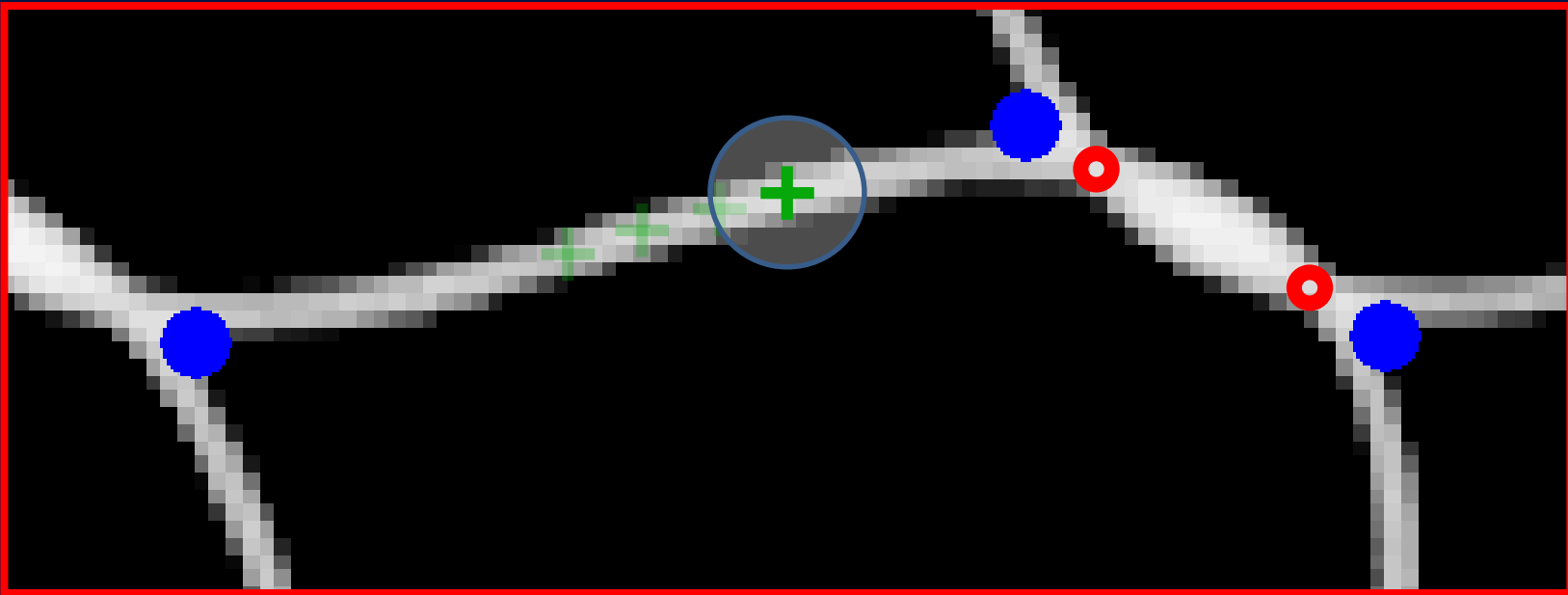

II. Data Processing

b) Shape and gliding

- Displacement fields / Strain fields
- Geometria of wire/loops
- Gliding => energy dissipation by friction

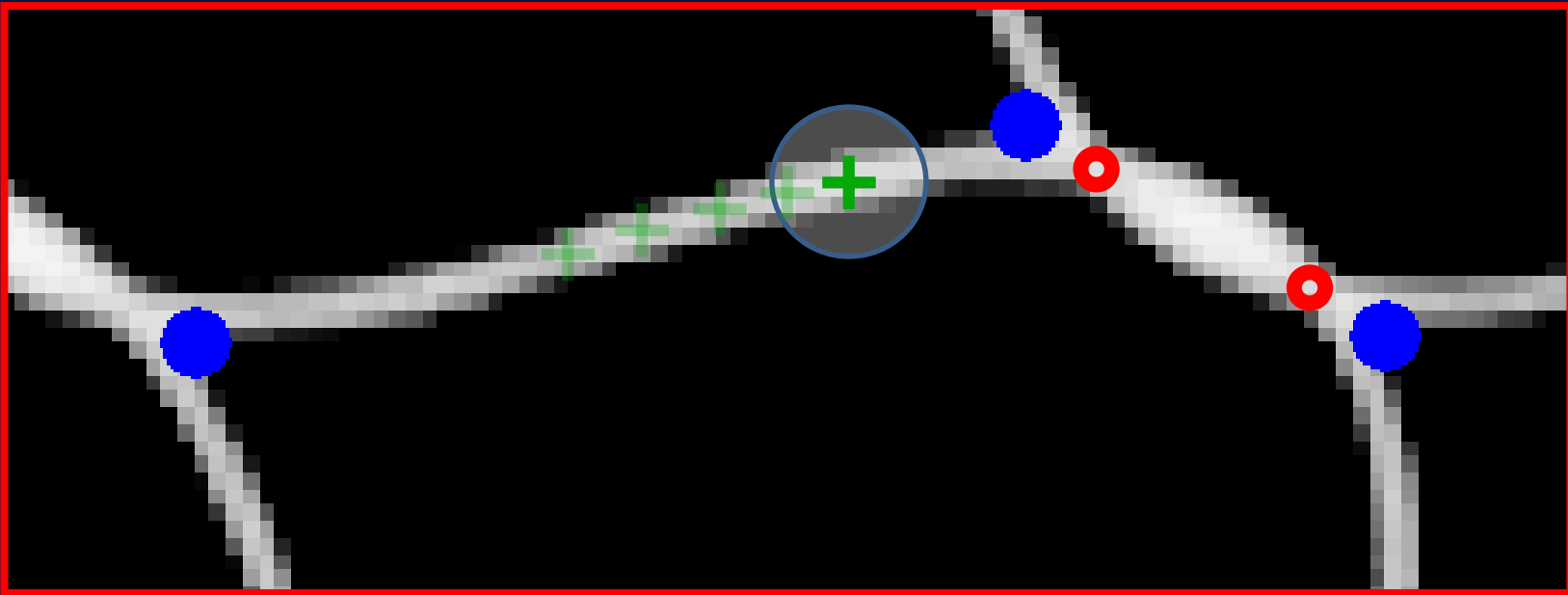

II. Data Processing

b) Shape and gliding

- Displacement fields / Strain fields
- Geometria of wire/loops
- Gliding => energy dissipation by friction

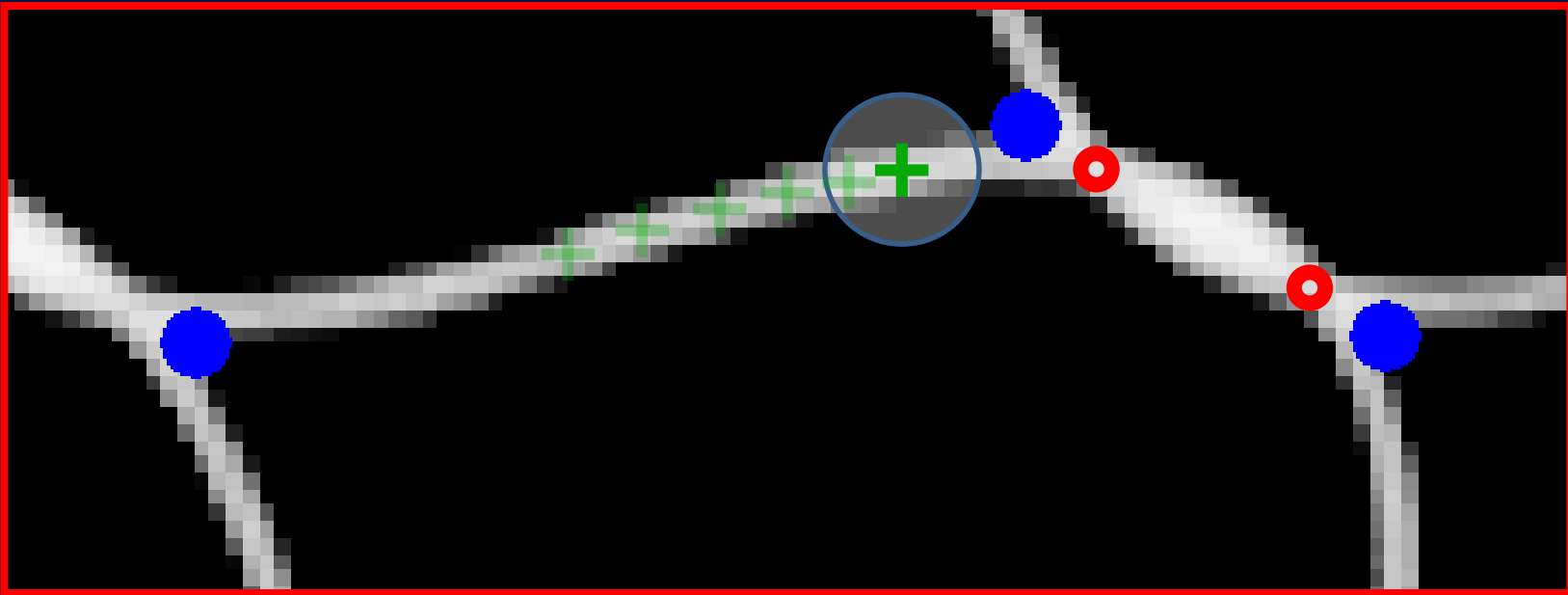

II. Data Processing

b) Shape and gliding

- Displacement fields / Strain fields
- Geometria of wire/loops
- Gliding => energy dissipation by friction

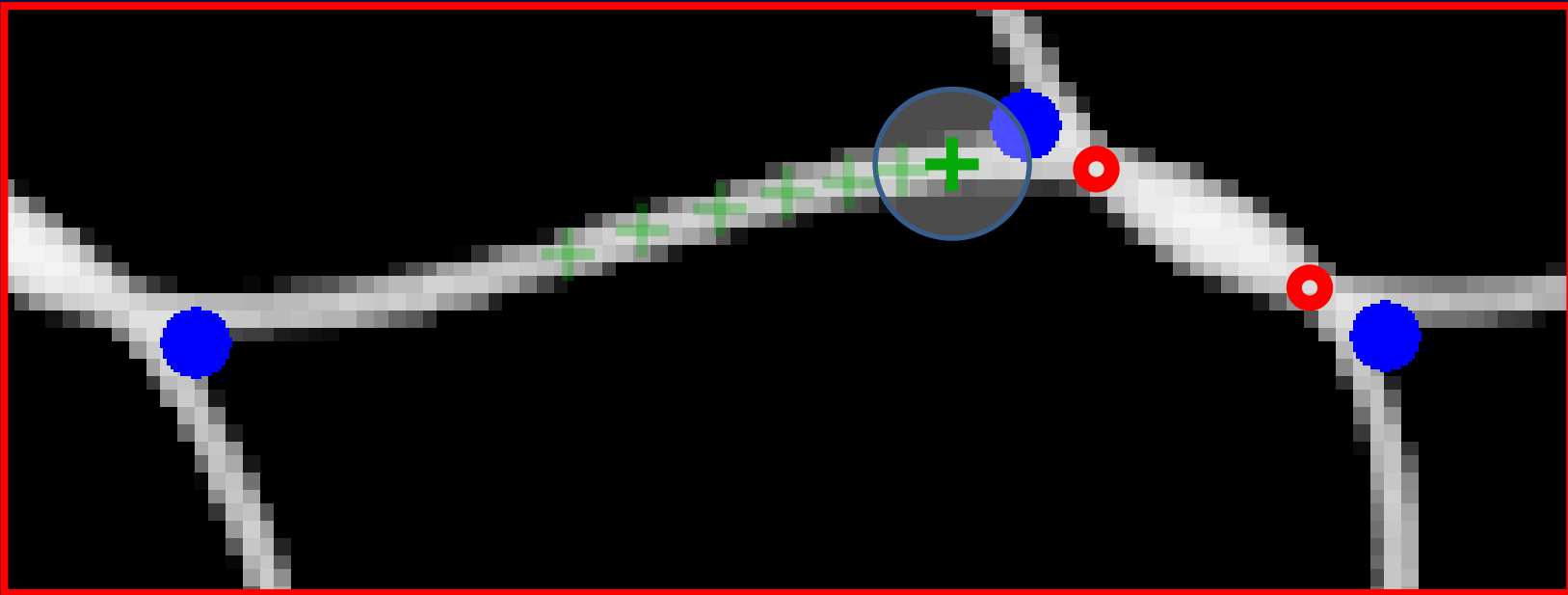

II. Data Processing

b) Shape and gliding

- Displacement fields / Strain fields
- Geometria of wire/loops
- Gliding => energy dissipation by friction

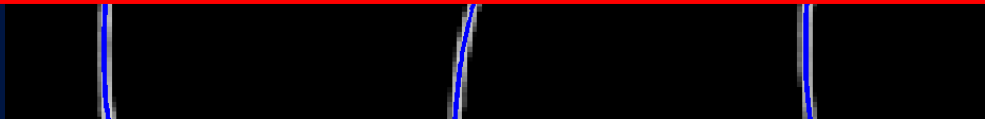
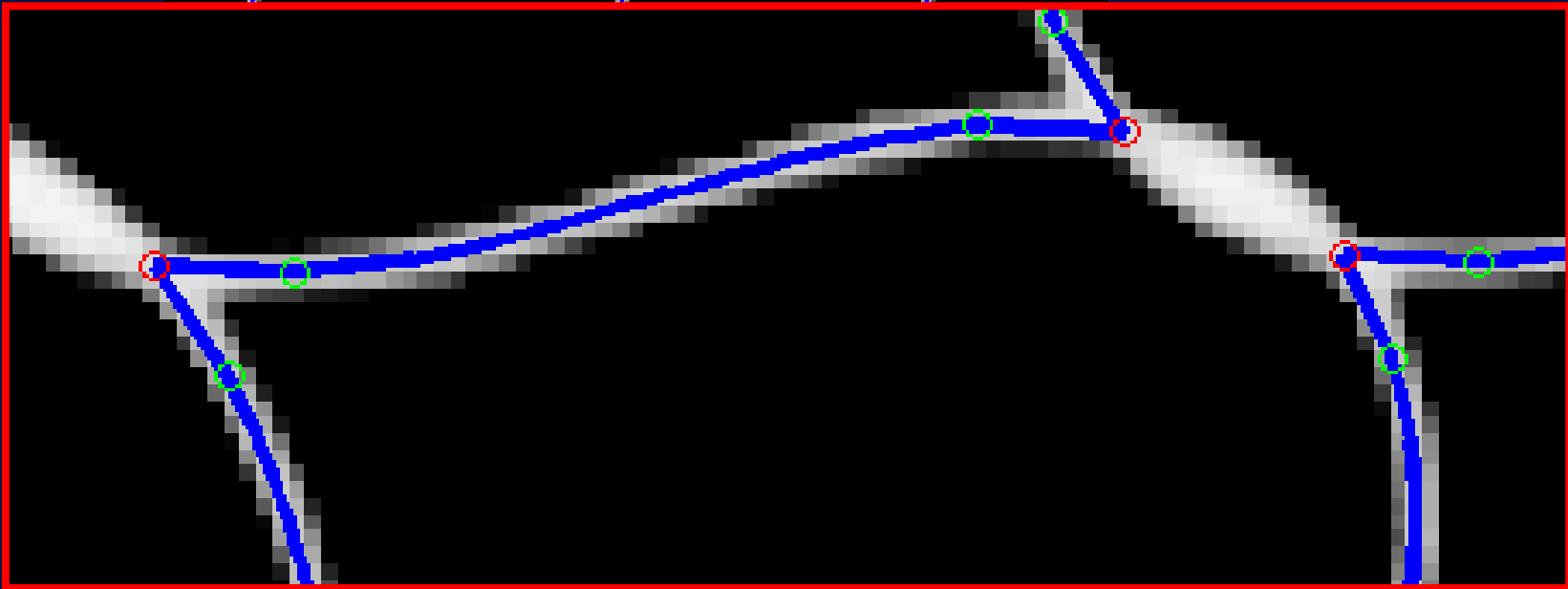
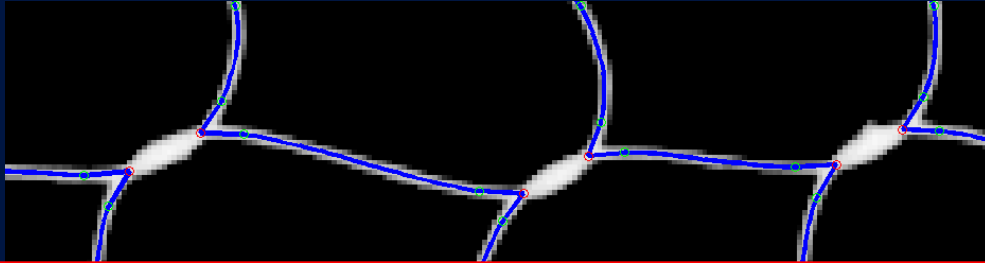

II. Data Processing

b) Shape and gliding

- Displacement fields / Strain fields
- Geometria of wire/loops
- Gliding => energy dissipation by friction

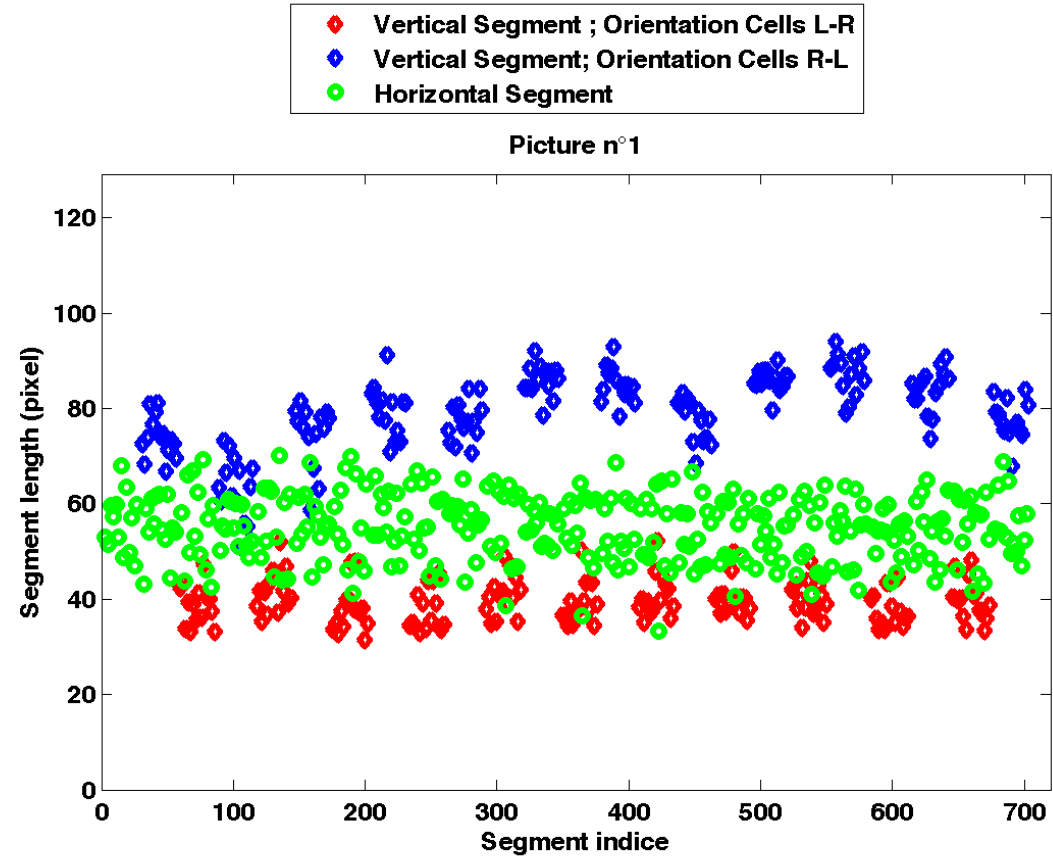
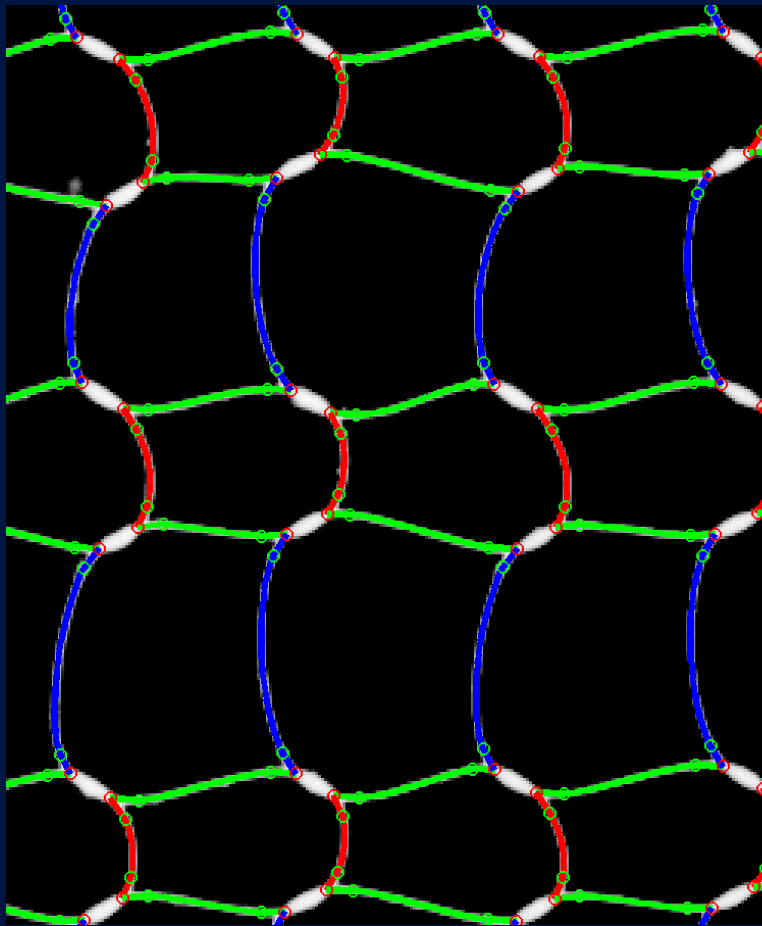

II. Data Processing

b) Shape and gliding

- Displacement fields / Strain fields
- Geometria of wire/loops
- Gliding => energy dissipation by friction

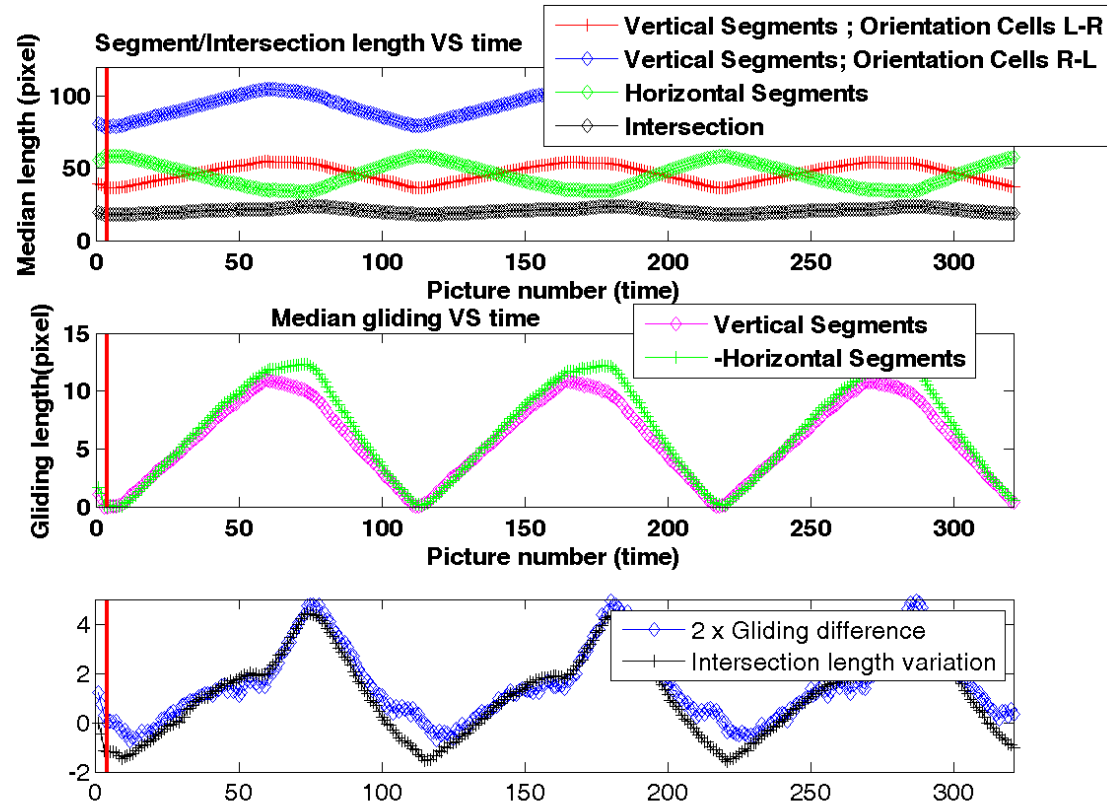
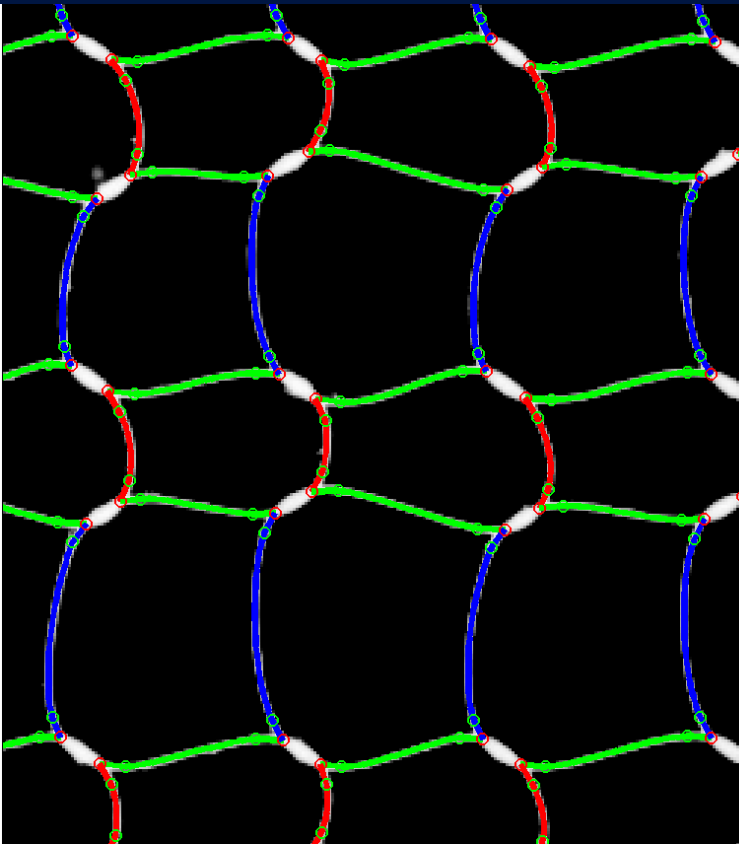

Outline

Introduction

I. DIC

II. Data Processing

III. Comparision

IV. Further processing

Conclusion

Conclusion

- Displacement fields / Strain fields
- Geometria of wire/loops
- Gliding => energy dissipation by friction

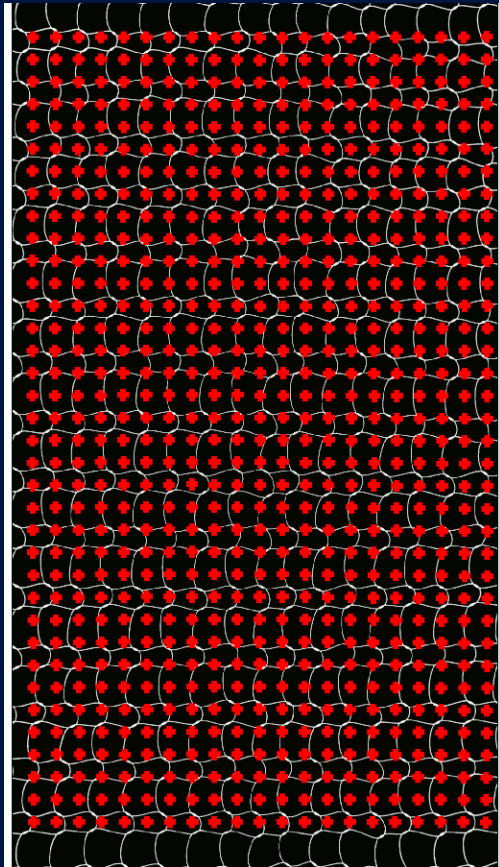

DIC (Vic 2009)

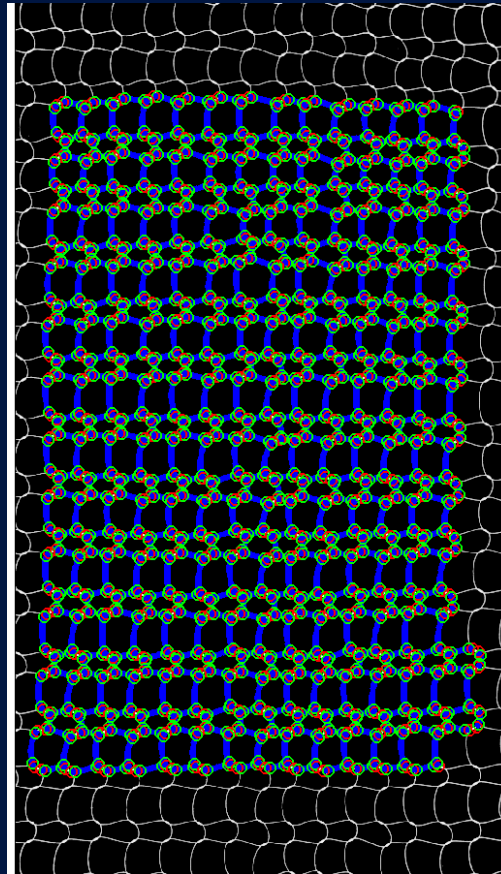

Home made data processing

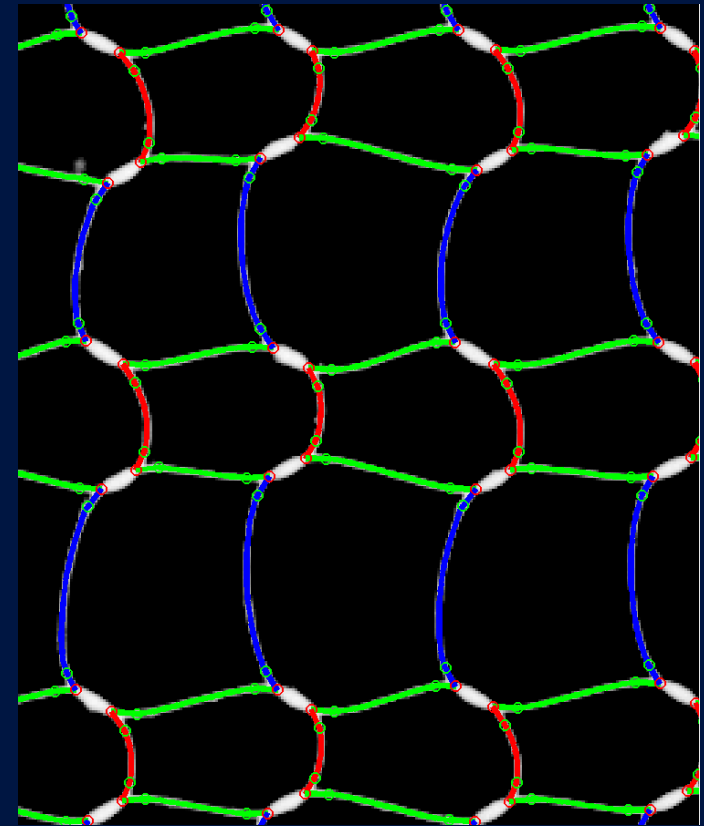

The End

Friction

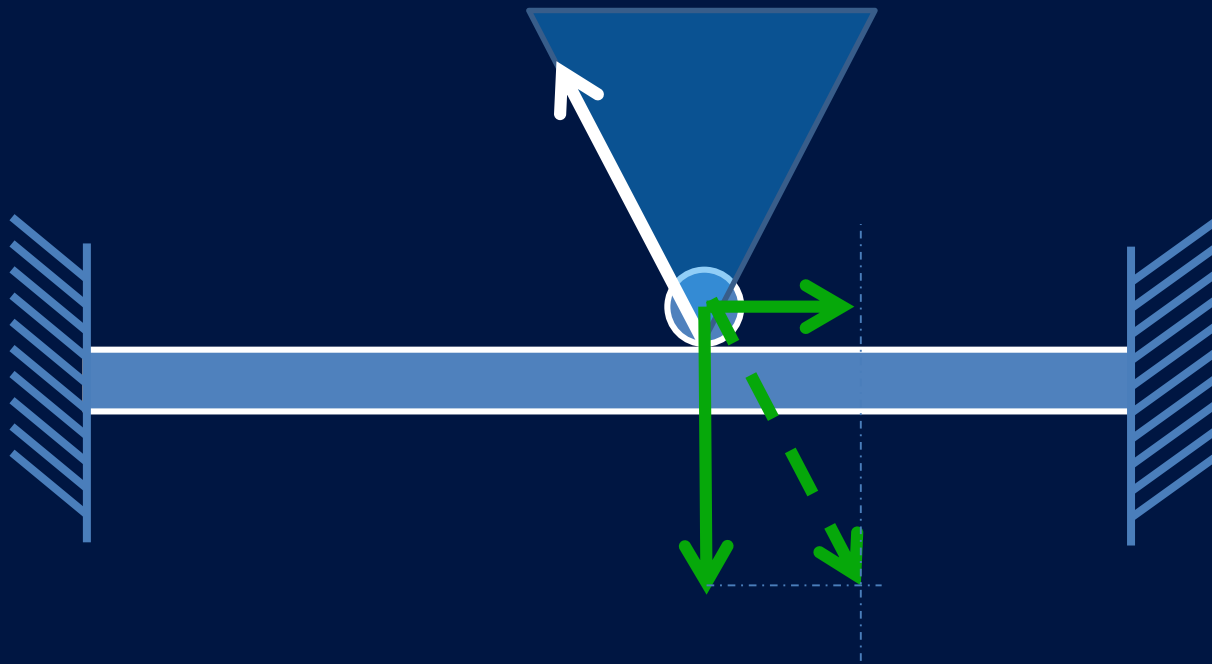

Idée : Solide soumis à deux efforts

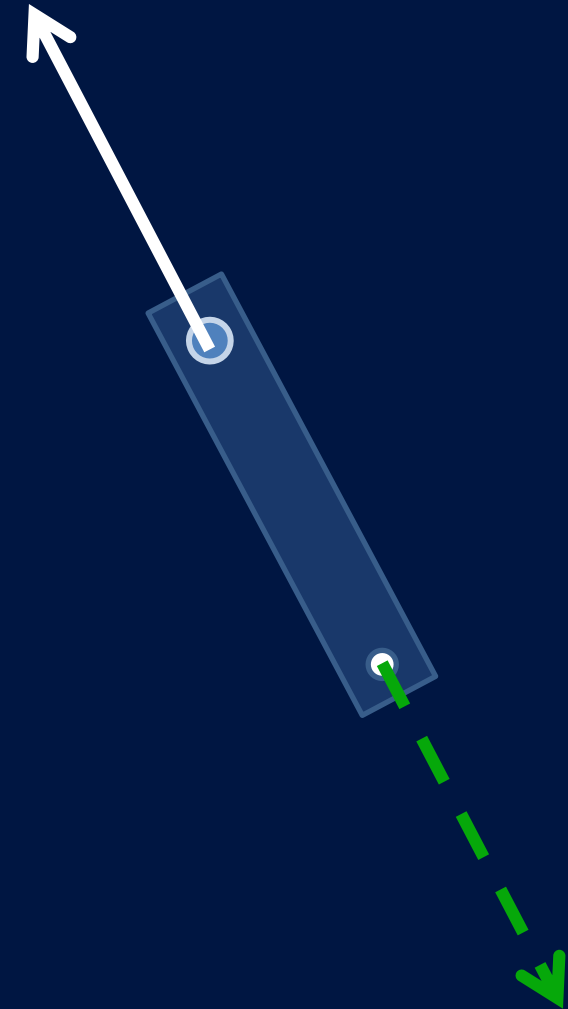

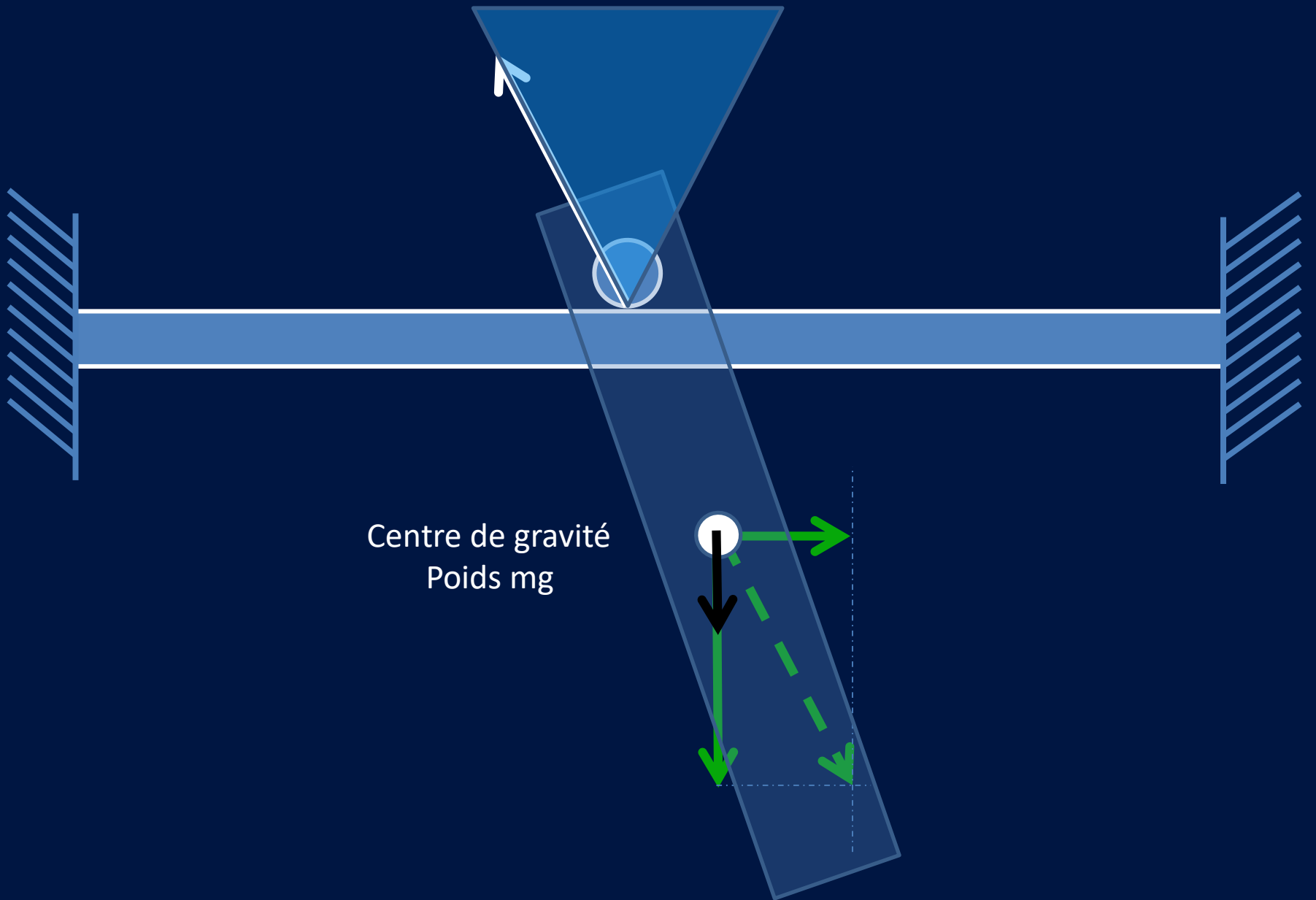

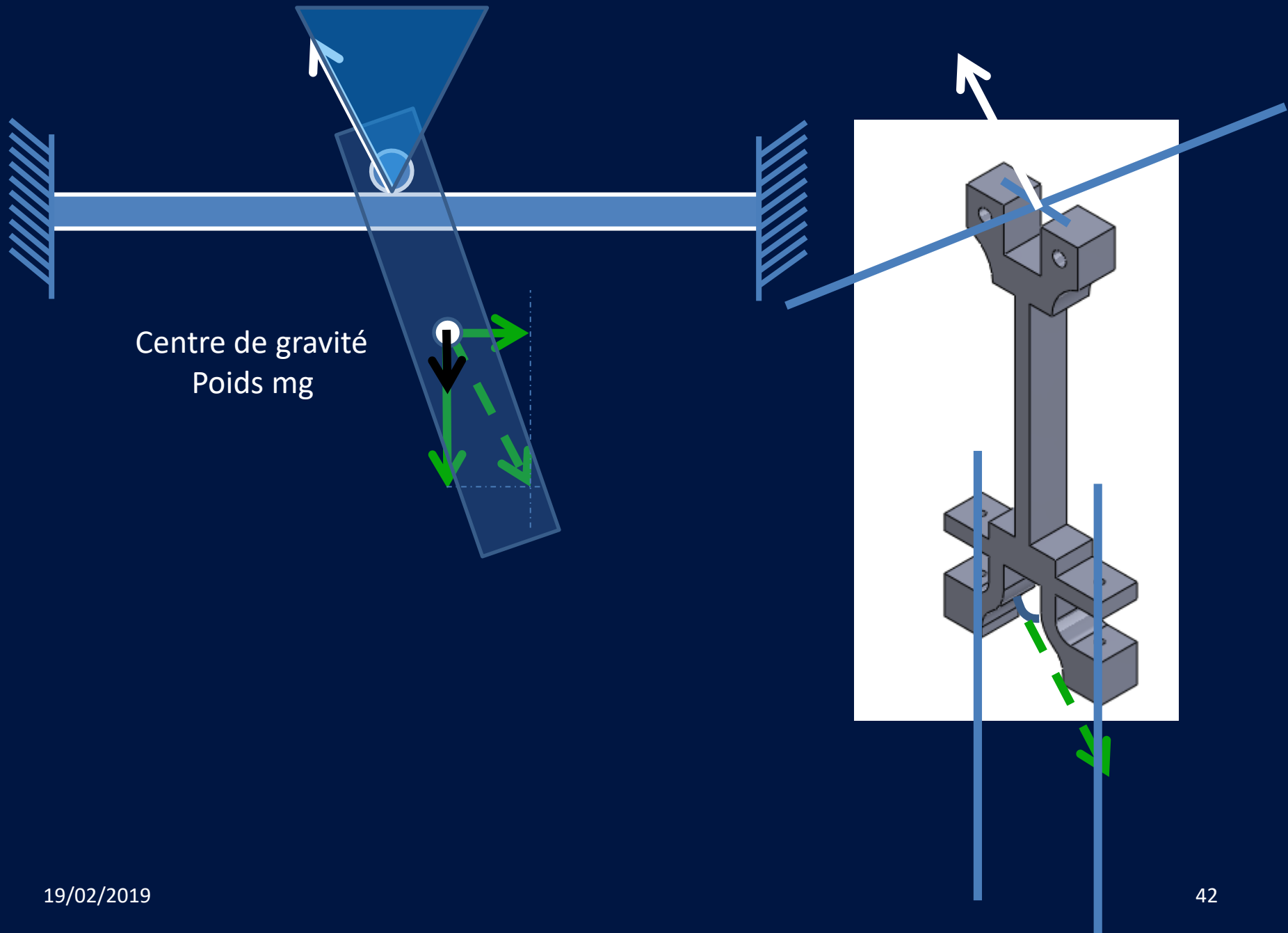



Introduction : utilité

Historiquement :
Matériau architecturé,
Tricots de métaux (acier, NiTi, etc)

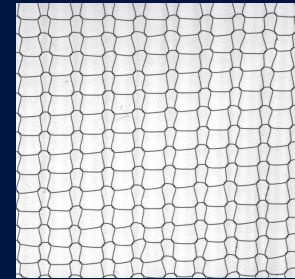

Ludek Heller

Utilisation possibles : en NiTi, c'est biocompatible !

Langue de boeuf

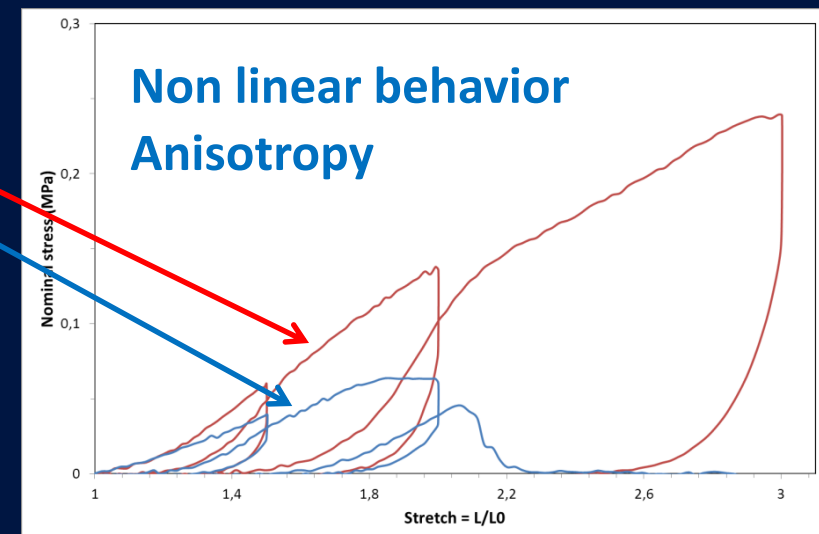
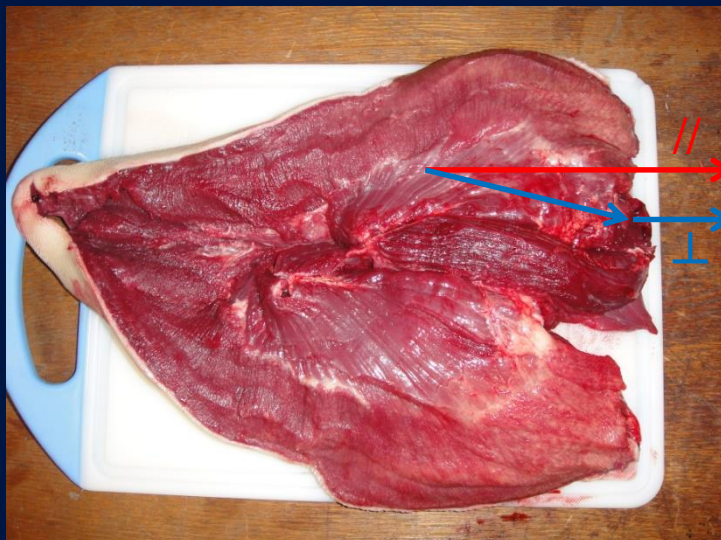

Introduction : utilité

Historiquement :

Matériau architecturé,
Tricots de métaux (acier, NiTi, etc)

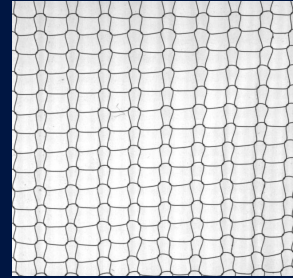

Ludek Heller

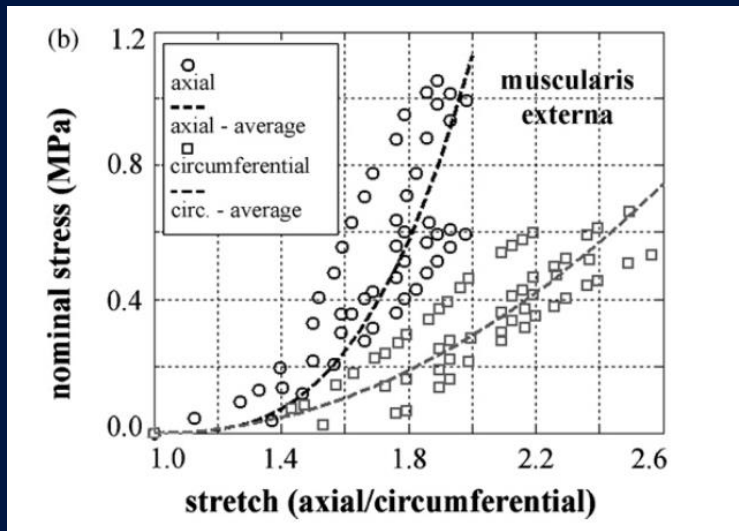

Results from tensile tests on tissue samples from oesophagus; Natali et al (2009)

19/02/2019

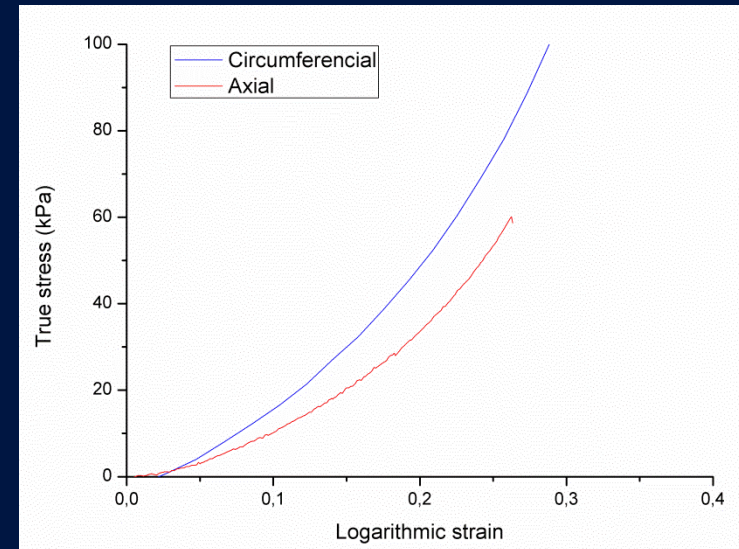

Tensile test on artery; Chagnon et al (2012)

Introduction : utilité

Historiquement :
Matériau architecturé,
Tricots de métaux (acier, NiTi, etc)

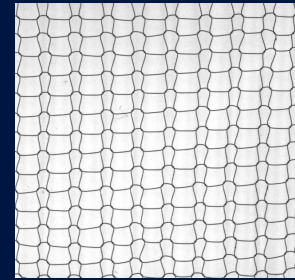

Ludek Heller

Paramètres :

- Géométrie,
- Diamètres,
- Traitement thermiques
- Shape setting

Applications ?



...

Analyse: Géométrie initiale

Cellule i

- Position CdG,
- 4 Segments,
- Intersections.

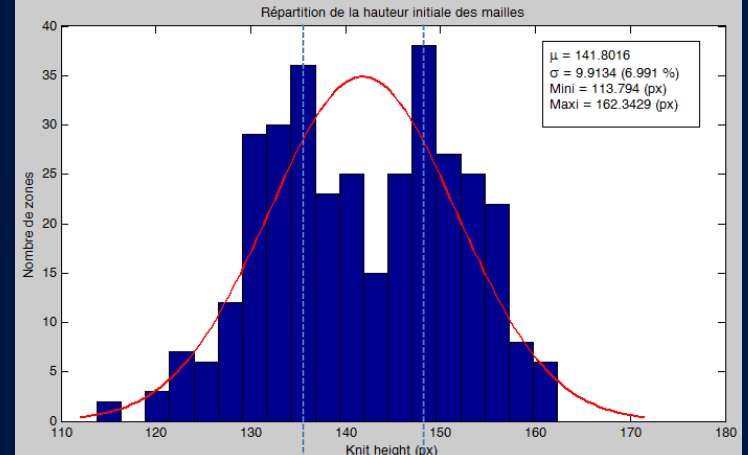
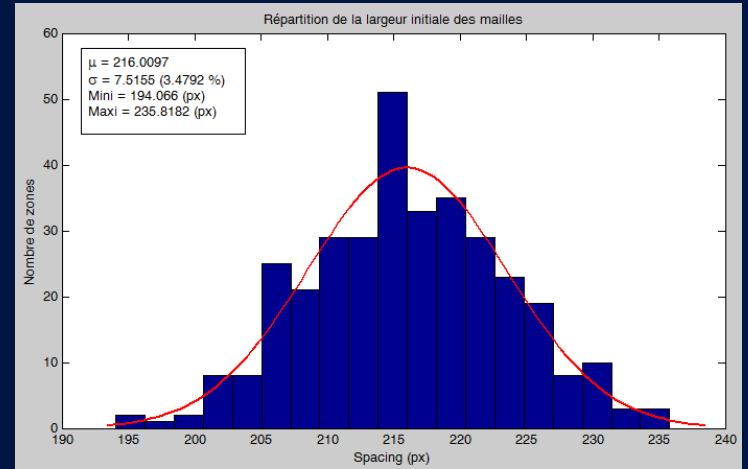
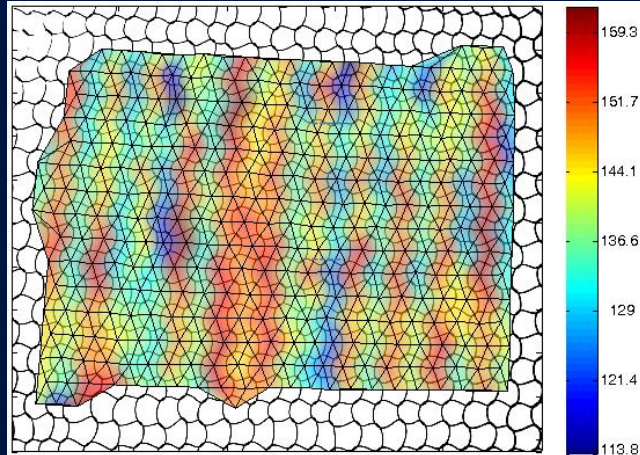
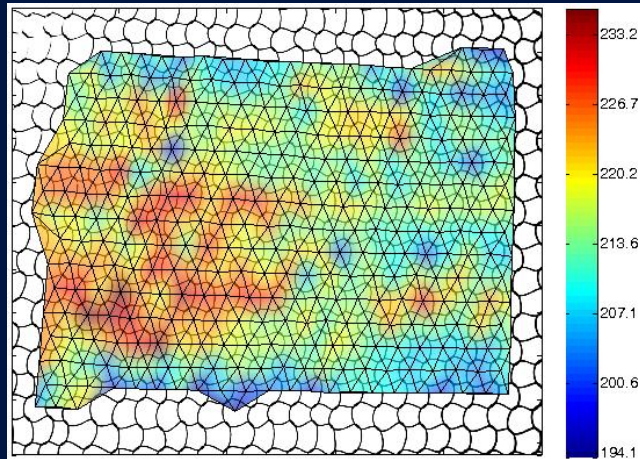
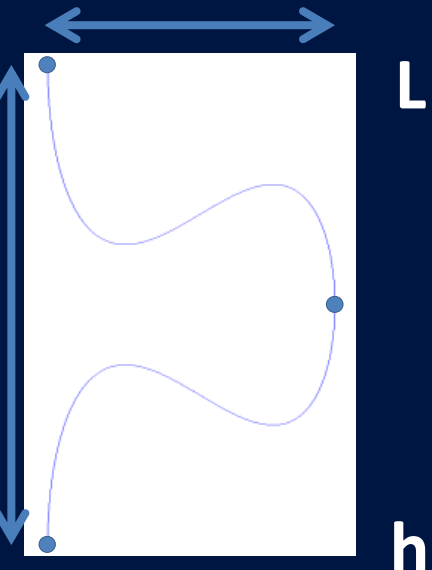

Analyse: Géométrie initiale

Cellule i

- Position CdG,
- 4 Segments,
- Intersections.

largeur 1

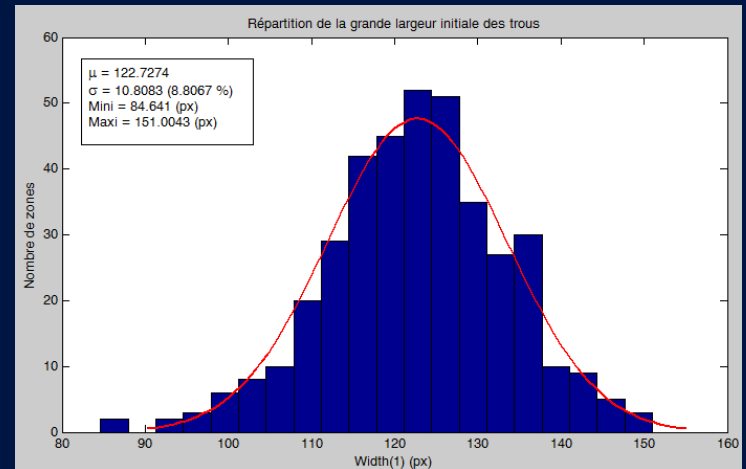
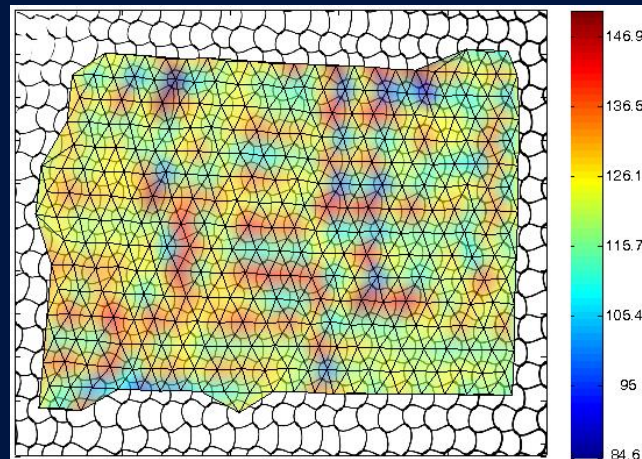

largeur 2

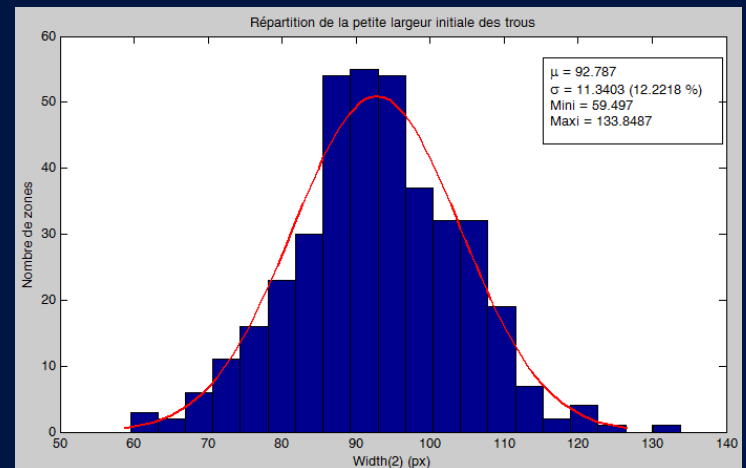
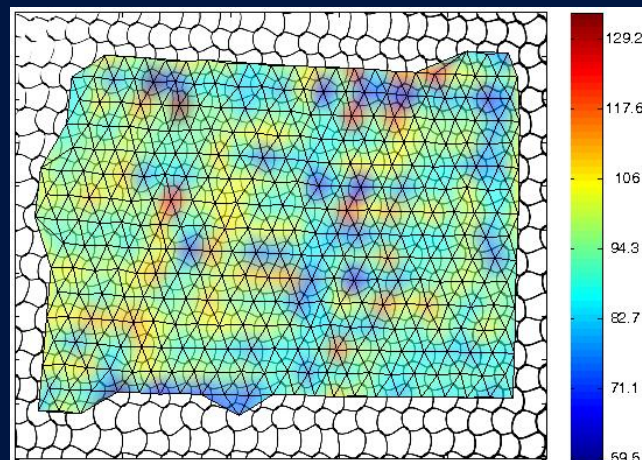

Analyse: Géométrie initiale

Cellule i

- Position CdG,
- 4 Segments,
- Intersections.

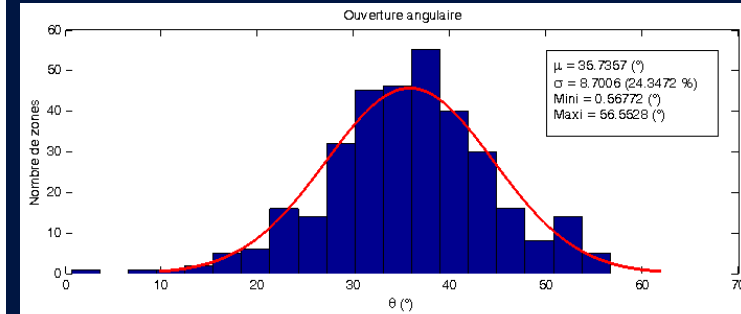
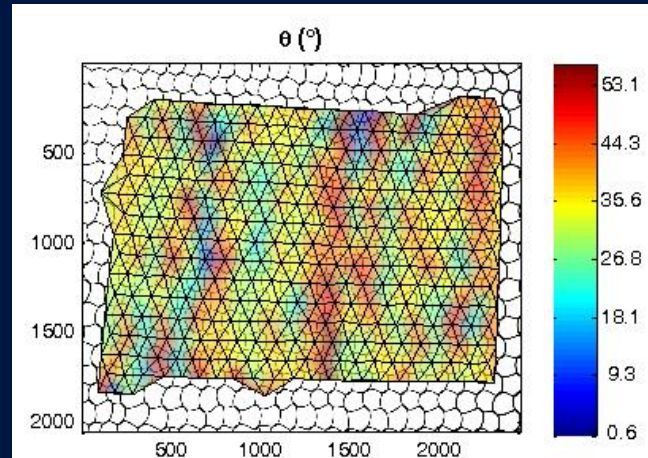
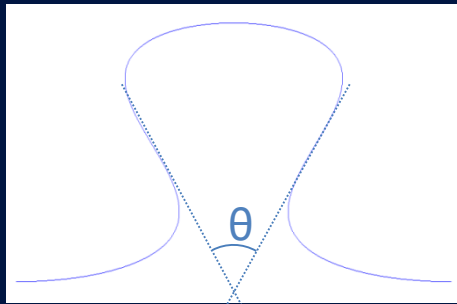

Axe de symétrie (théorique)

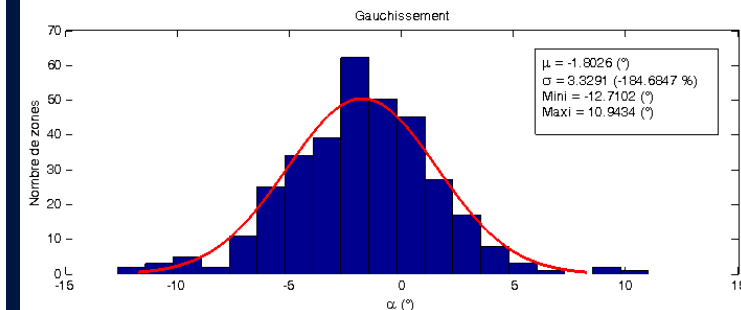
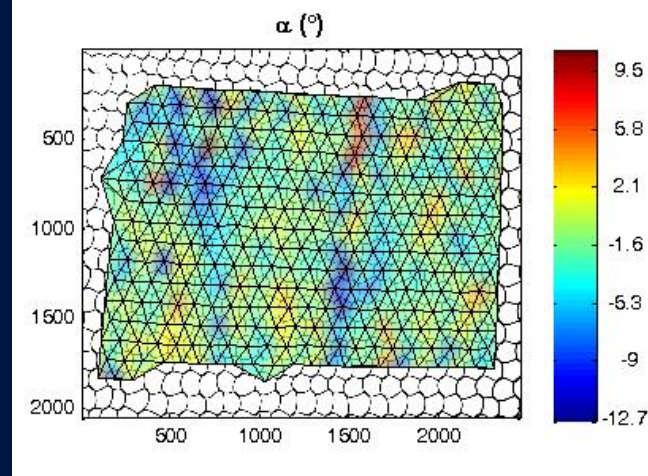
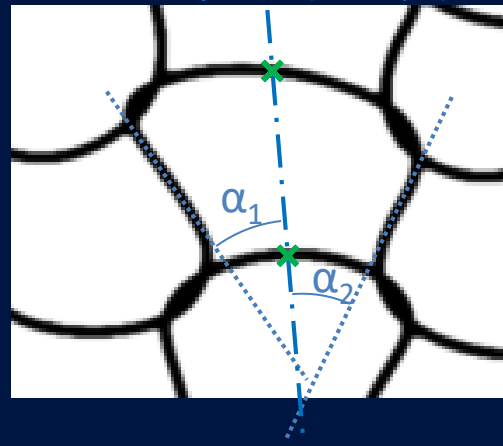

Approche numérique : Modèle EF

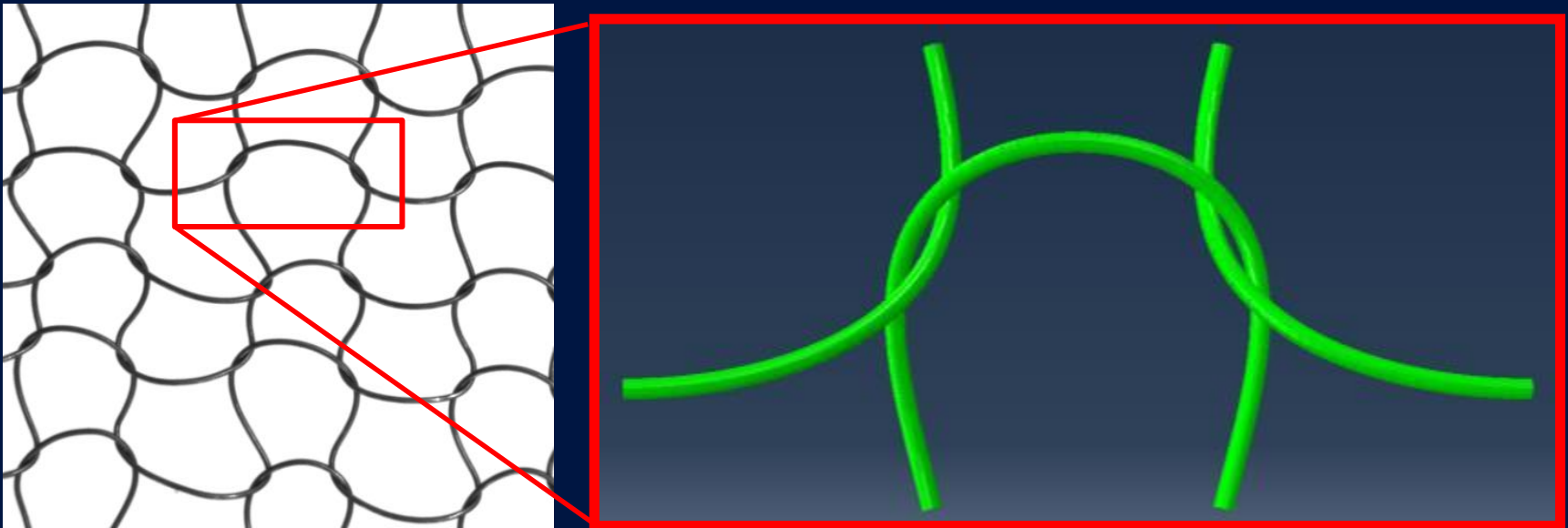

Fil NiTi (Ni-54wt%) : $\varnothing 0,1$ mm,
X: 4,35 mm / Y: 2,305 mm

- Géométrie "moyenne" représentative (??)
- Conditions limites: périodiques + déplacement
- Modèle de matériau : Bilinéaire (Acier) ou Auricchio
- Frottement sec (Expérience "maison", ok)