



Method to extract
Stress-Strain functions
from pure **torsion**/**bending**
experimental tests.



N. Connesson¹, G. Anthérieu¹, D. Favier¹

¹ Université de Grenoble Alpes, UMR 5525 TIMC-IMAG,
Grenoble, France

Introduction

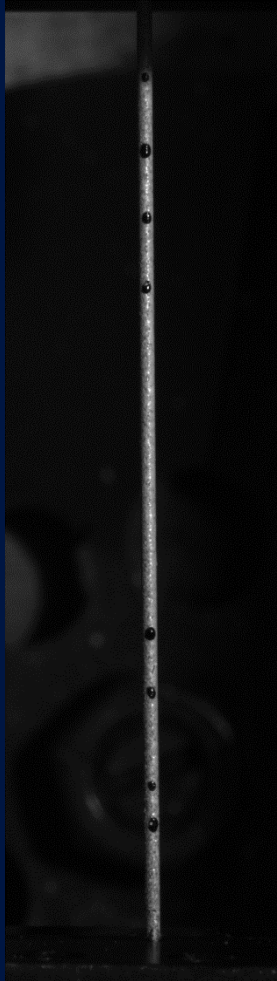

Extract

Stress-strain behaviors

- Tensile ✓
- Compressive X
- Shear X

- Pure Bending
- Torsion

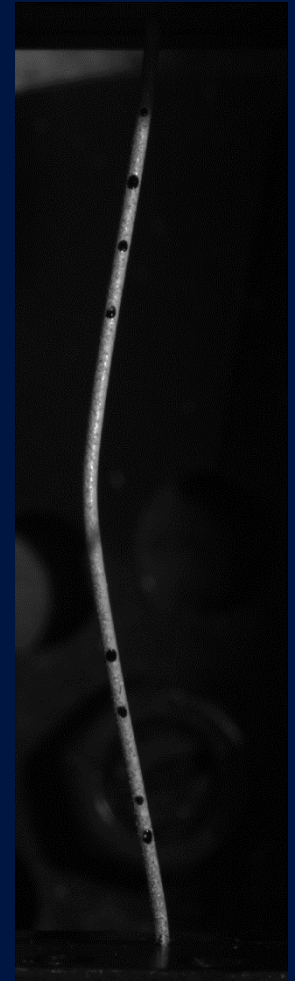

Copper wire ($D=0.59$ mm)

NiTi ($D=0.6$ mm)

Introduction

- Torsion

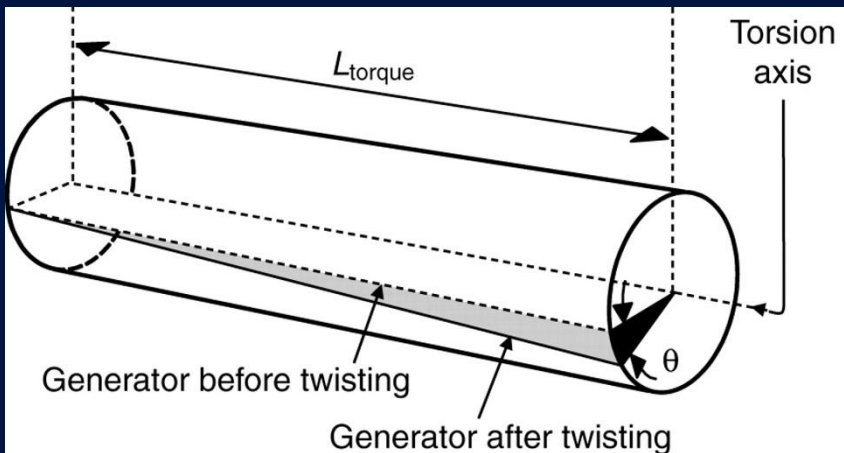

➤ Shear gradient

- Pure Bending

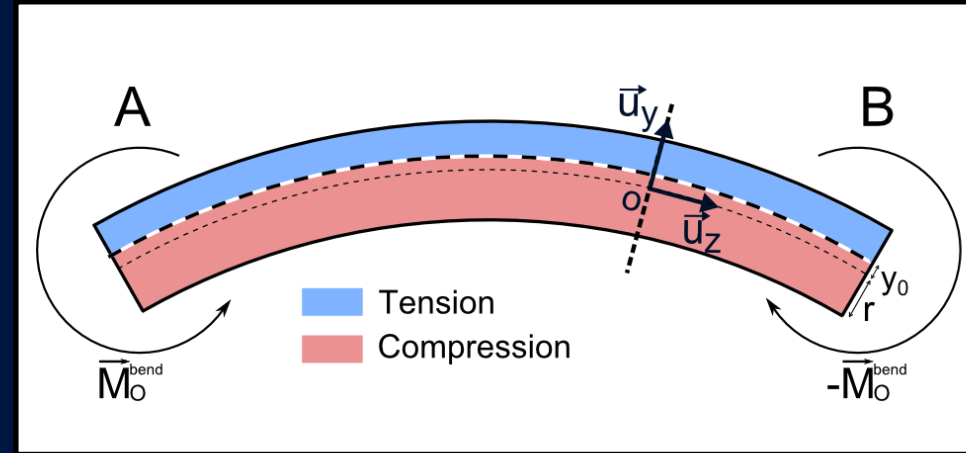

➤ Tensile to compressive gradient

Extract these Stress-strain behaviors ?
Perform such experiments ?

Introduction

- Pure Bending

No load transmitted but one moment



Only one angle imposed to the specimen (Hyperstatic $h=1$)

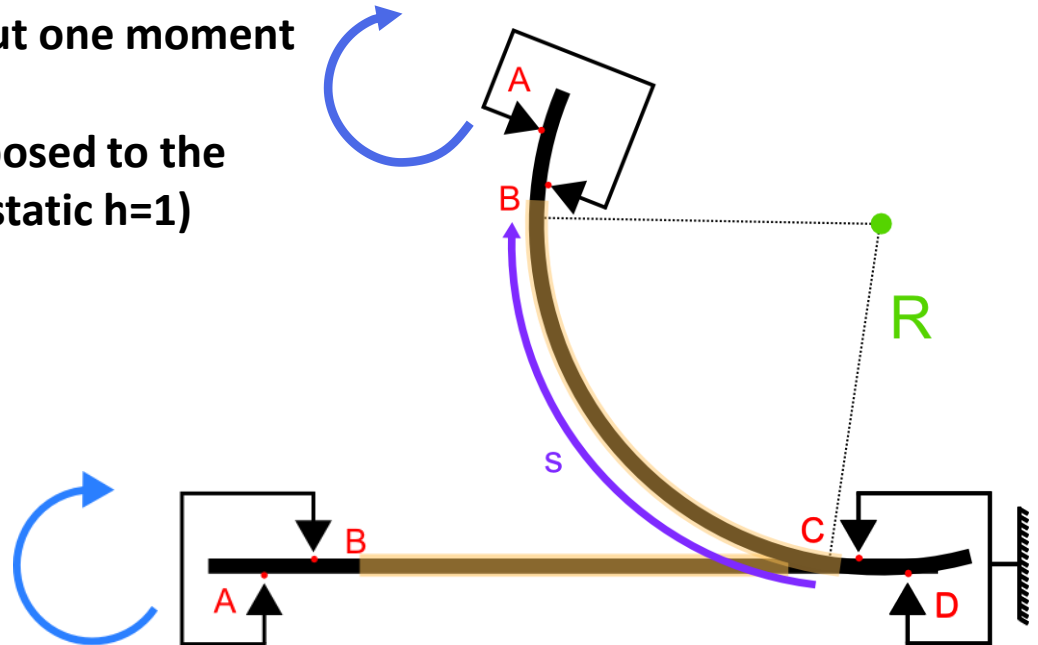
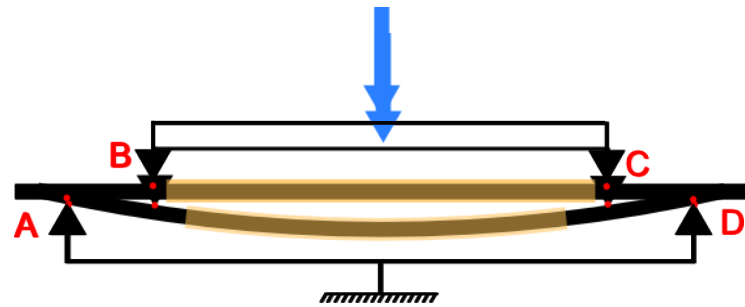

Introduction

- Pure Bending

Toward pure Bending mechanism

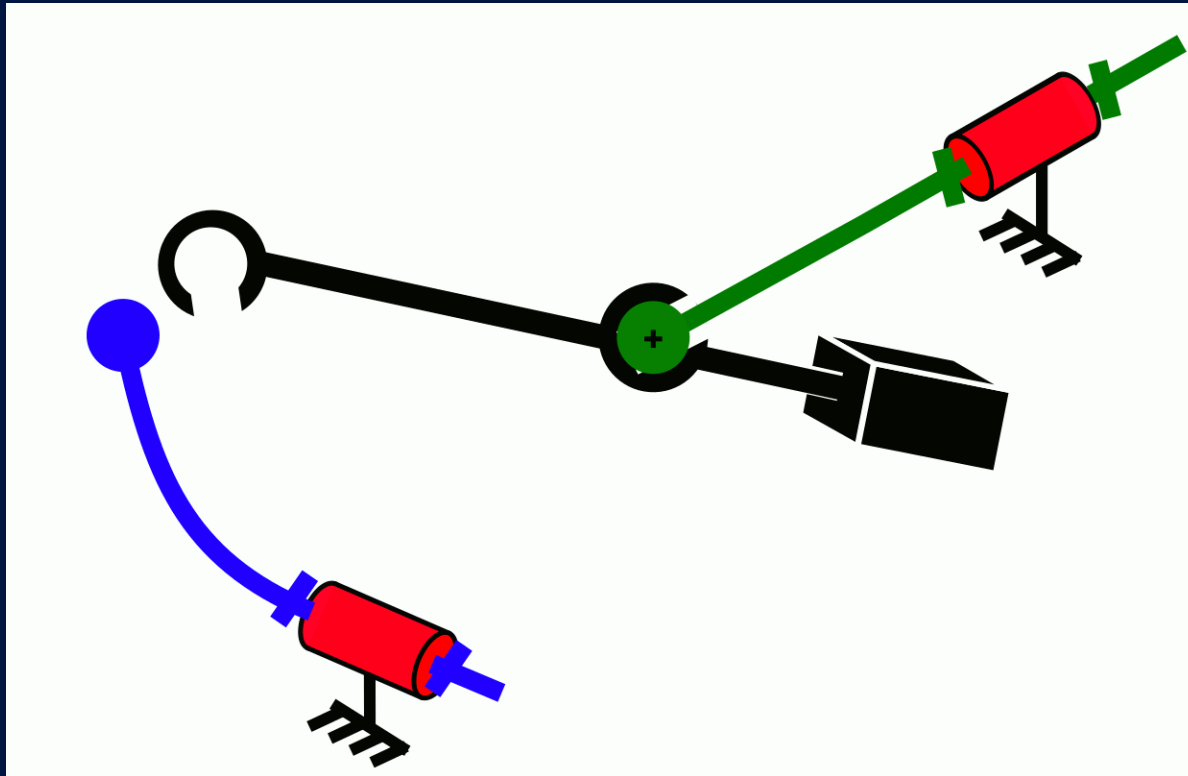

Introduction

- Pure Bending

Toward pure Bending mechanism

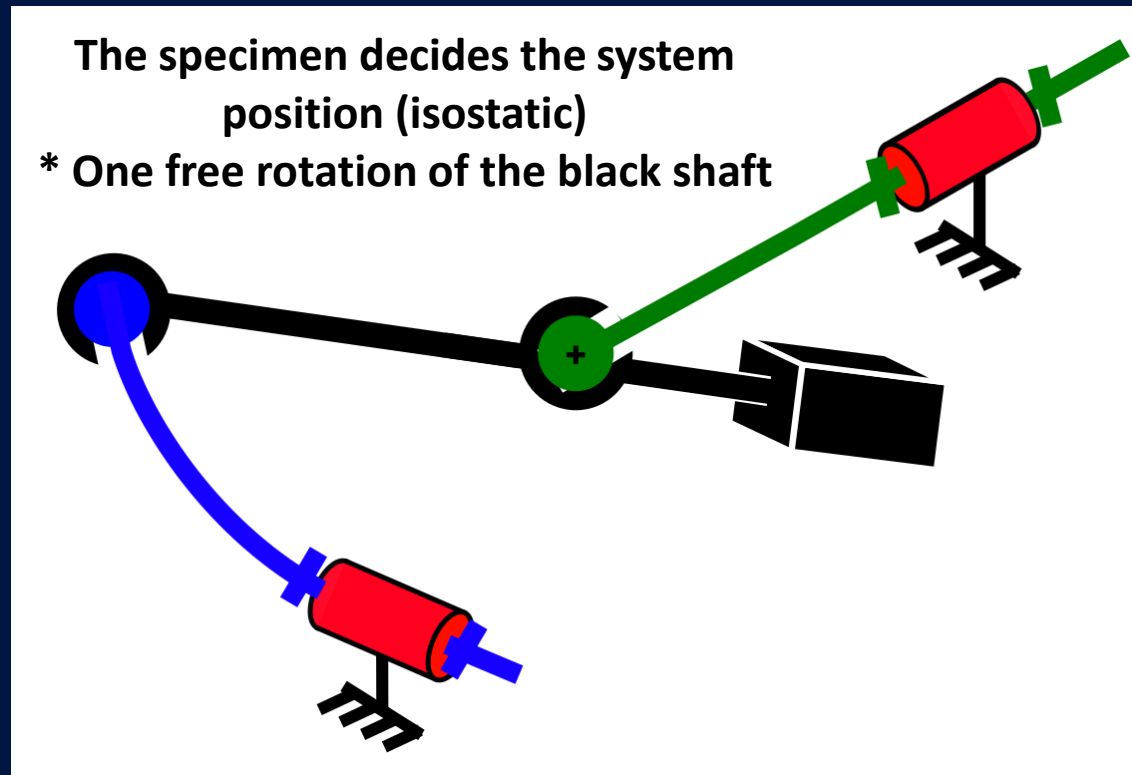

Introduction

- Pure Bending

Pure Bending mechanism

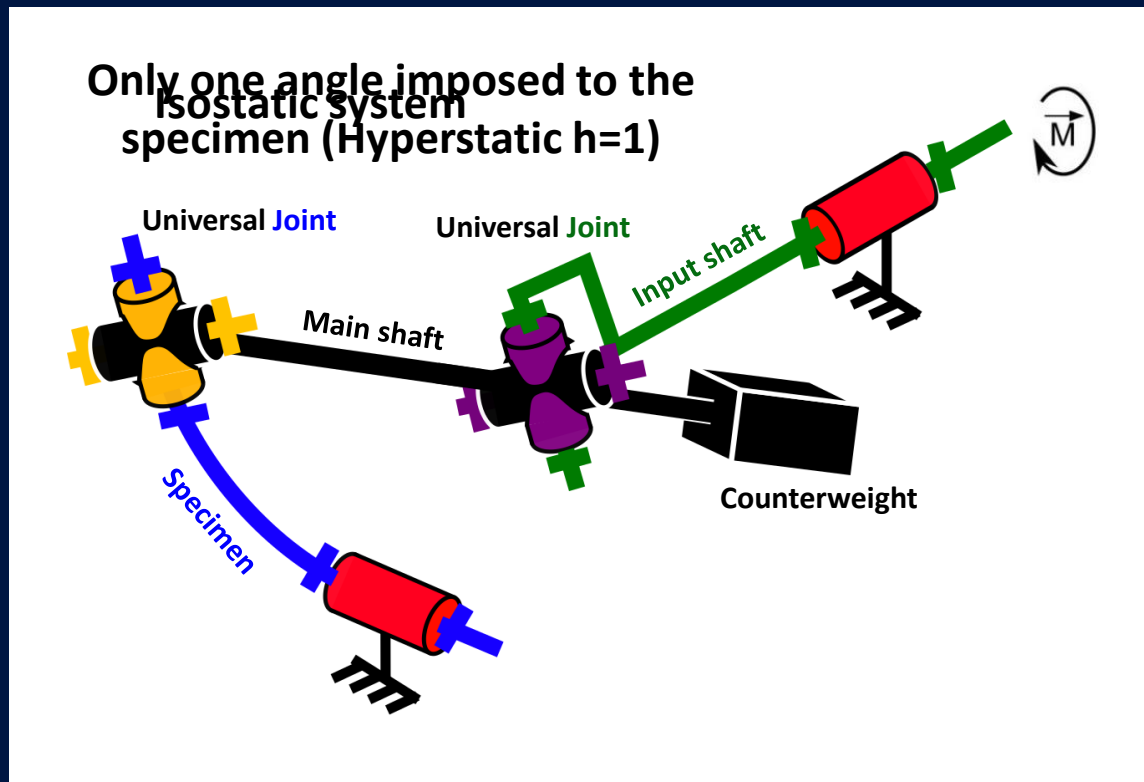

Introduction

- Pure Bending

Pure Bending mechanism

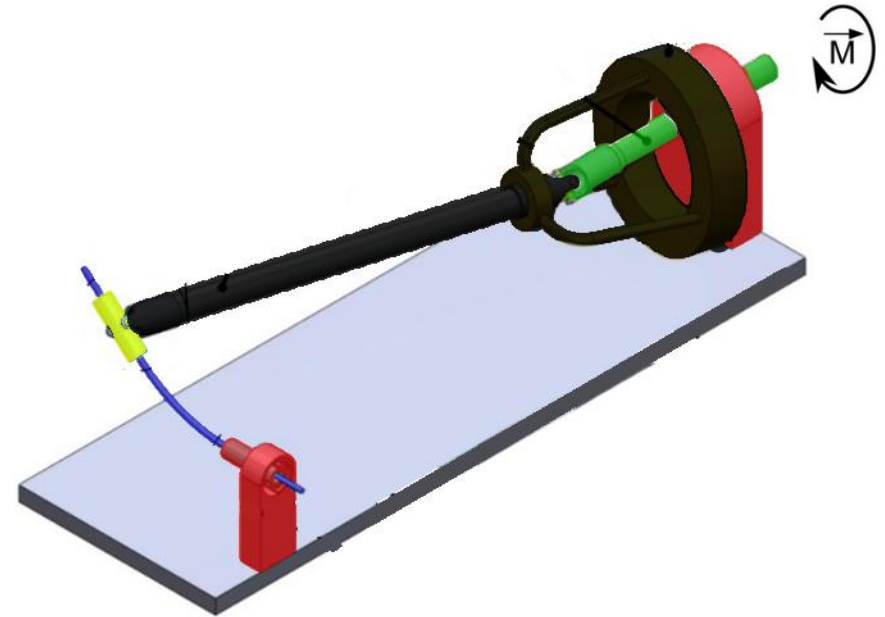
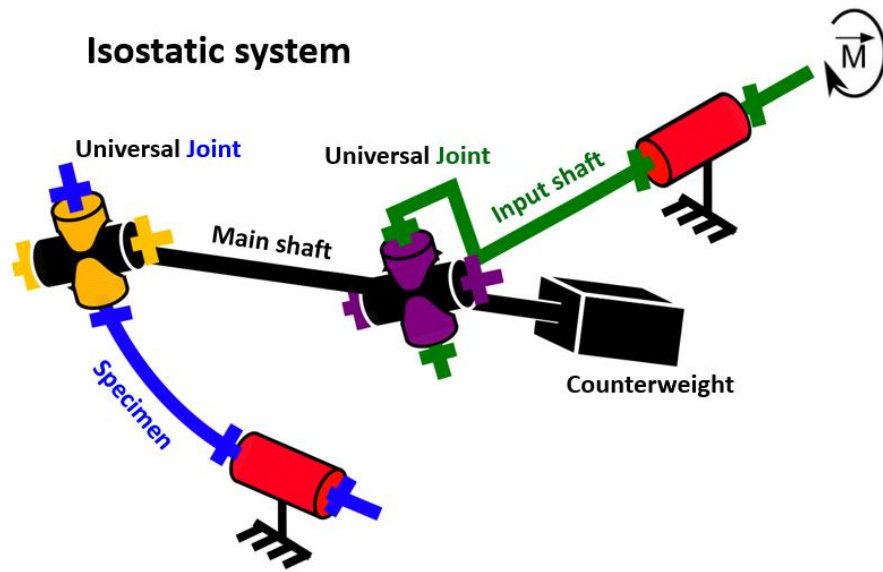

[Connesson2014] N.Connesson, G.Antherieu, D.Favier, Y.Payan, Dispositif de test mécanique en flexion pure et procédé de mise en œuvre, 2014, PCT/FR2014/051547

[Antherieu2016] G.Antherieu, N.Connesson, D.Favier, Y.Payan, « Principle and experimental validation of a new apparatus allowing large deformation in pure bending: application to thin wire », 2015, Experimental mechanics 56 (3), 475-482,

Introduction

- Pure Bending

Pure Bending mechanism

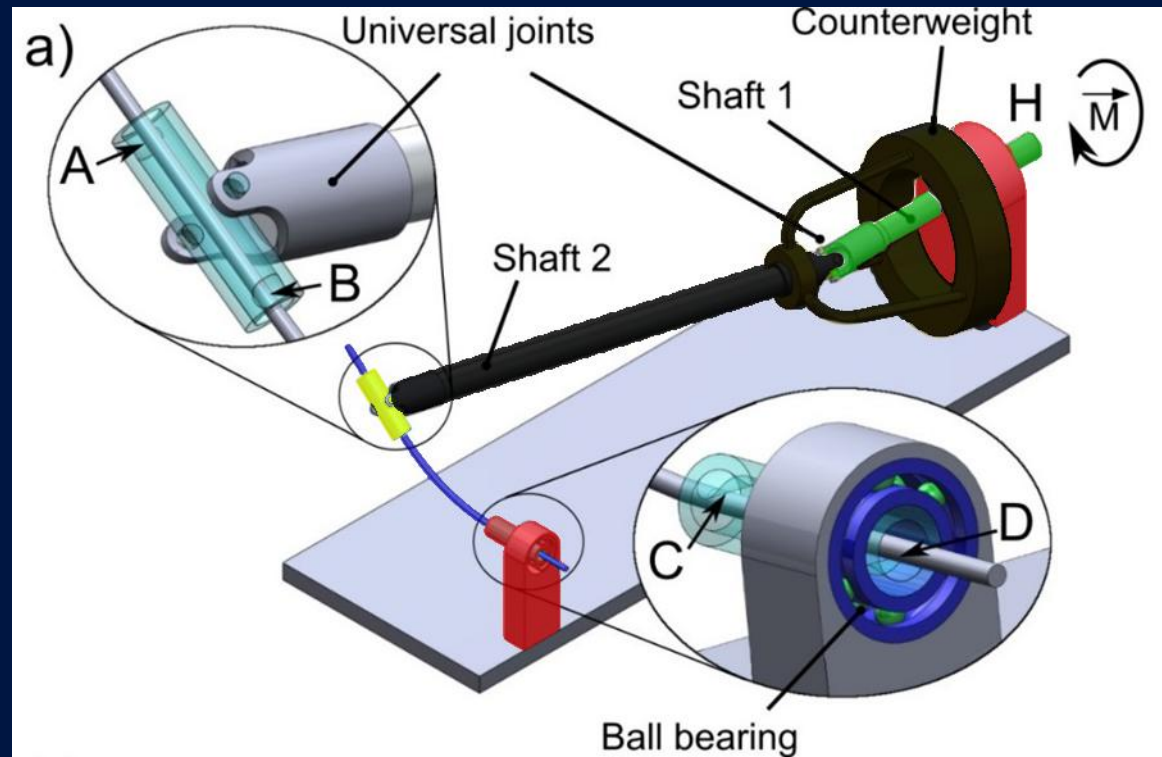

[Connesson2014] N.Connesson, G.Antherieu, D.Favier, Y.Payan, Dispositif de test mécanique en flexion pure et procédé de mise en œuvre, 2014, PCT/FR2014/051547

[Antherieu2016] G.Antherieu, N.Connesson, D.Favier, Y.Payan, « Principle and experimental validation of a new apparatus allowing large deformation in pure bending: application to thin wire », 2015, Experimental mechanics 56 (3), 475-482,

Introduction

- Pure Bending

Pure Bending mechanism

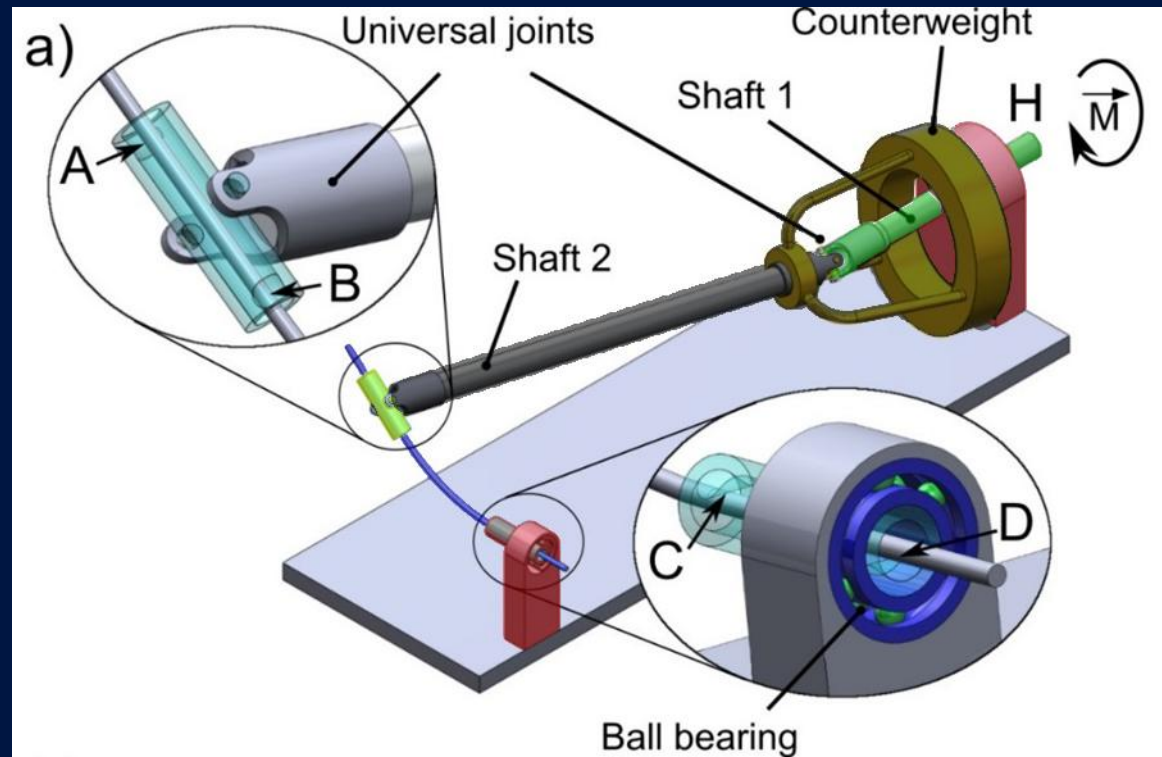

[Connesson2014] N.Connesson, G.Antherieu, D.Favier, Y.Payan, Dispositif de test mécanique en flexion pure et procédé de mise en œuvre, 2014, PCT/FR2014/051547

[Antherieu2016] G.Antherieu, N.Connesson, D.Favier, Y.Payan, « Principle and experimental validation of a new apparatus allowing large deformation in pure bending: application to thin wire », 2015, Experimental mechanics 56 (3), 475-482,

Introduction

- Pure Bending

Pure Bending mechanism

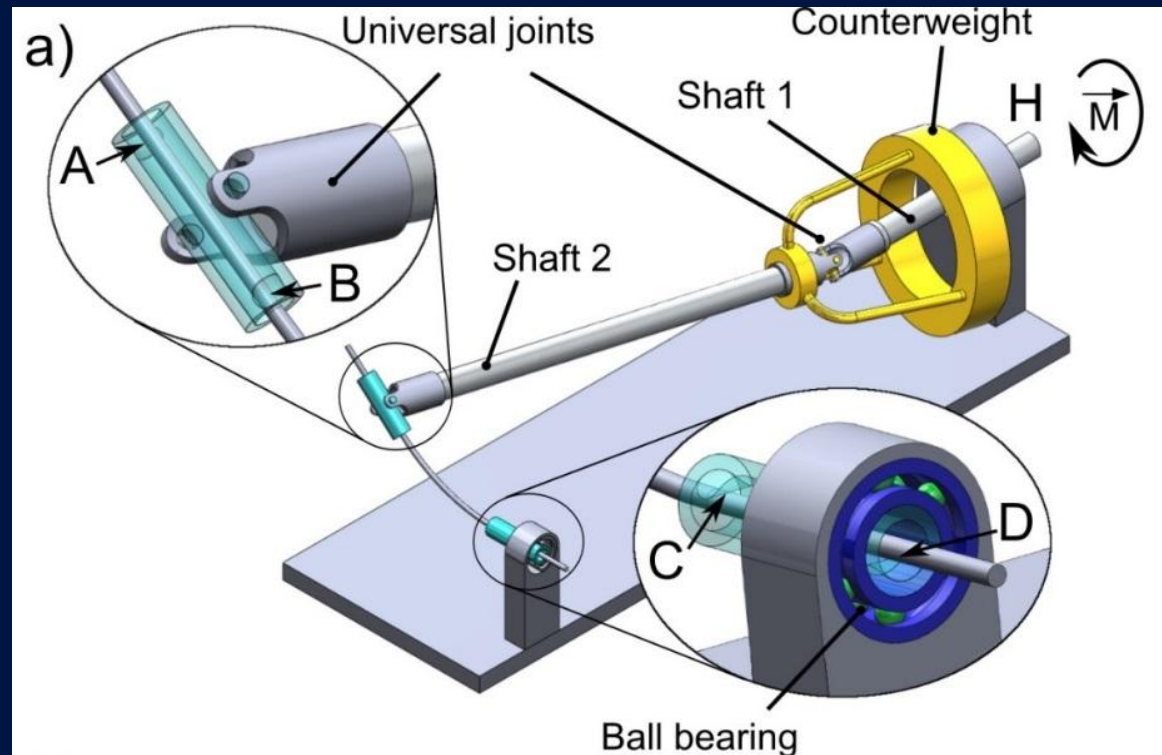

[Connesson2014] N.Connesson, G.Antherieu, D.Favier, Y.Payan, Dispositif de test mécanique en flexion pure et procédé de mise en œuvre, 2014, PCT/FR2014/051547

[Antherieu2016] G.Antherieu, N.Connesson, D.Favier, Y.Payan, « Principle and experimental validation of a new apparatus allowing large deformation in pure bending: application to thin wire », 2015, Experimental mechanics 56 (3), 475-482,

Introduction

- Pure Bending

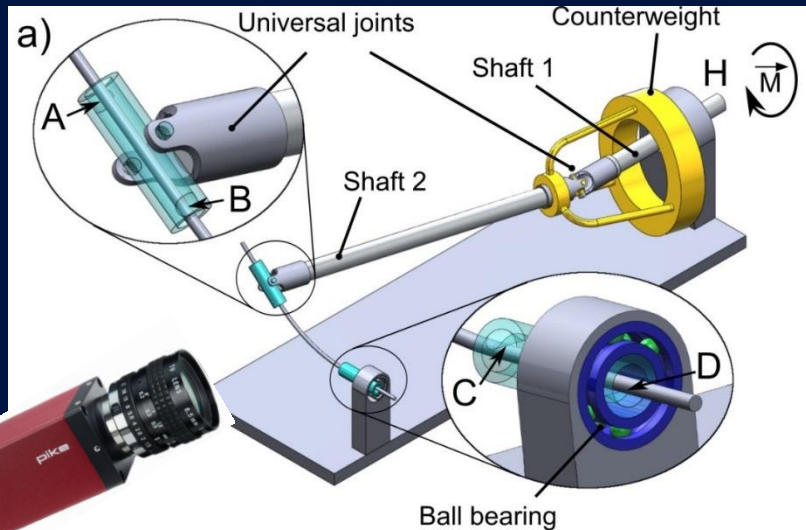

[Connesson2014] N.Connesson, G.Antherieu, D.Favier, Y.Payan, Dispositif de test mécanique en flexion pure et procédé de mise en œuvre, 2014, PCT/FR2014/051547

[Antherieu2016] G.Antherieu, N.Connesson, D.Favier, Y.Payan, « Principle and experimental validation of a new apparatus allowing large deformation in pure bending: application to thin wire », 2015, Experimental mechanics 56 (3), 475-482,

Introduction

- Pure Bending

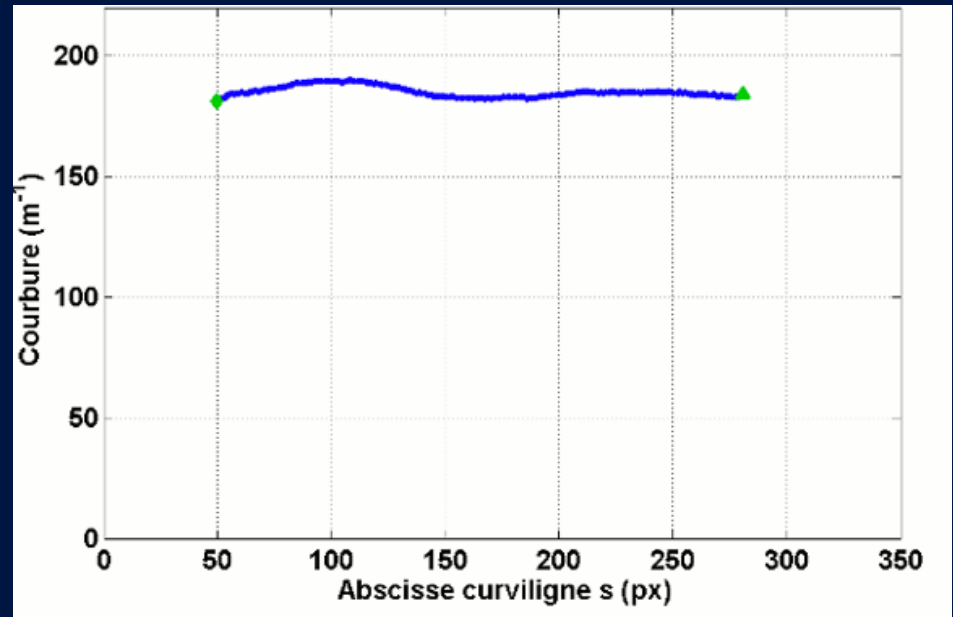
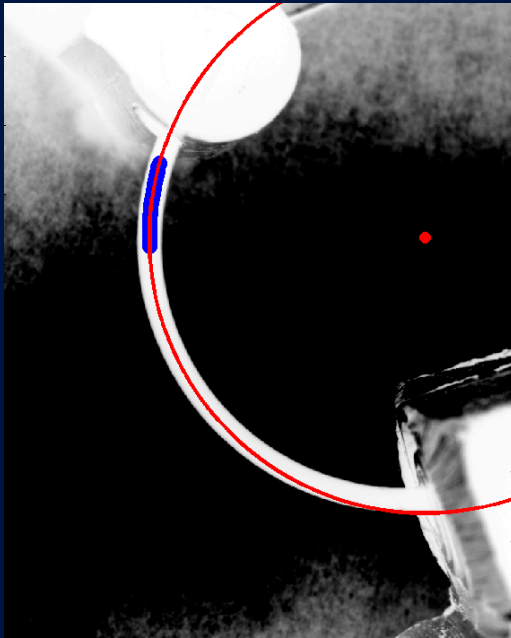

Introduction

- Pure Bending

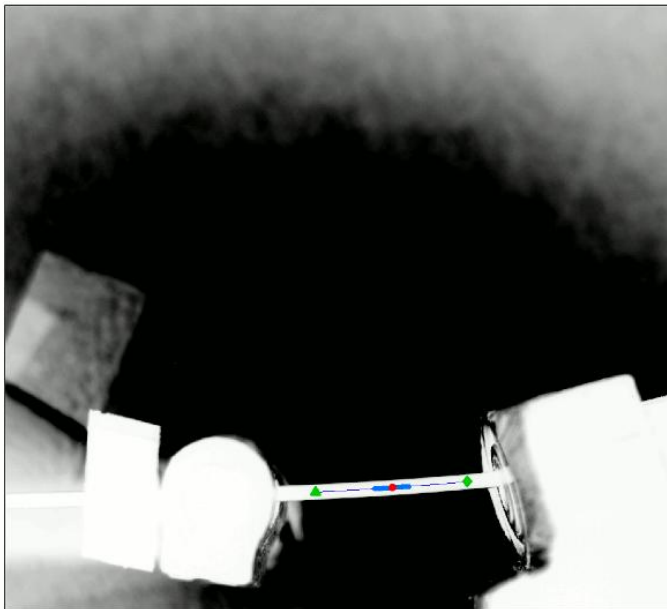
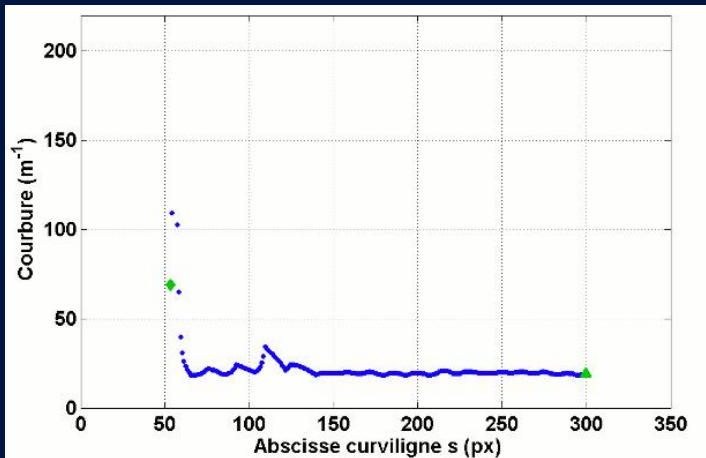

Uniform local curvature



Pure Bending +
Homogeneous material +
Identical cross section

Introduction

Copper wire ($D=0,59$ mm)

- Torsion

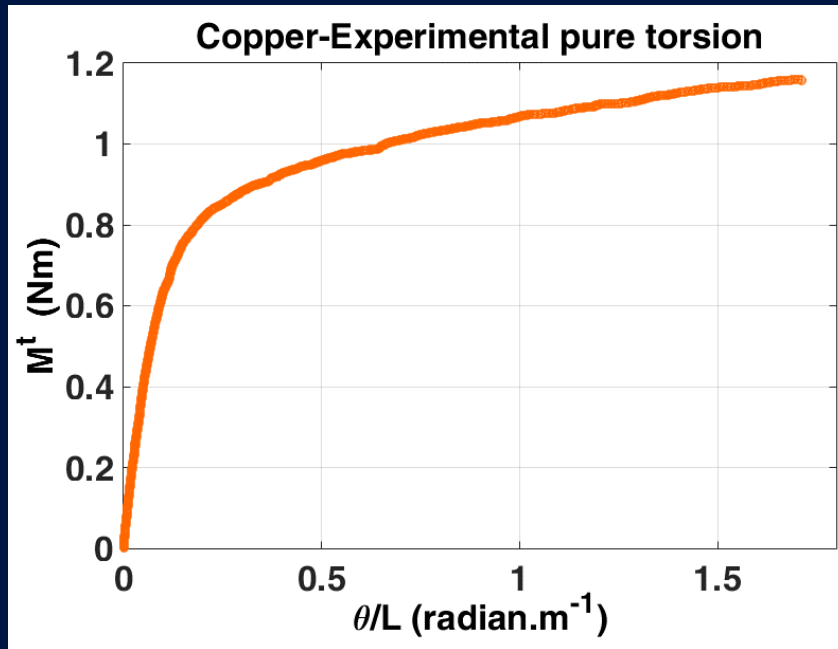

➤ Shear gradient

- Pure Bending

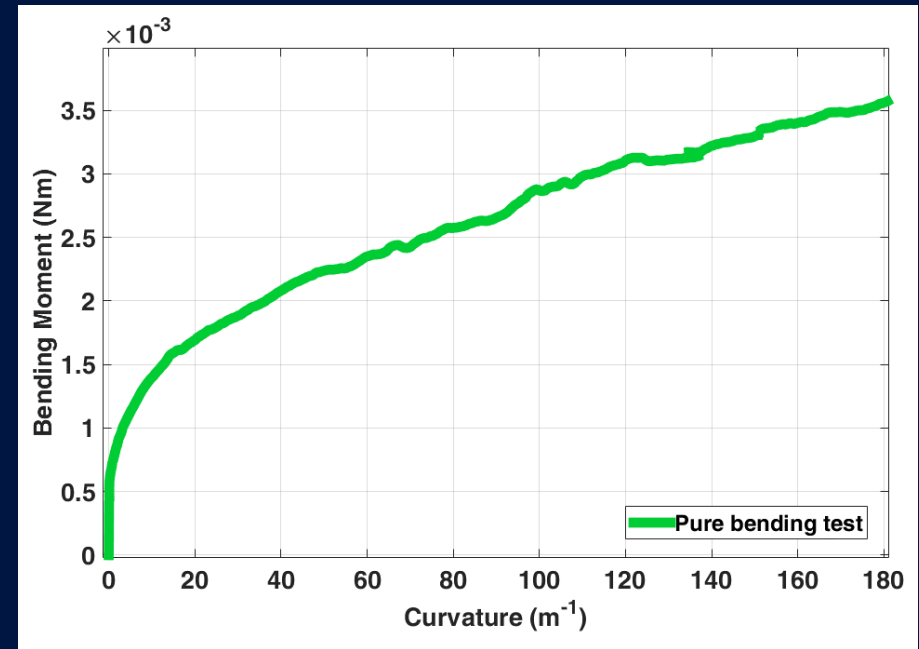

➤ Tensile to compressive gradient

Extract these Stress-strain behaviors ?

Outline :

- I. Extraction method (**Torsion**)
- II. Application to experiments (**Torsion**)
- III. Application to experiments (**Bending**)
- IV. Conclusion

I. Extraction method (Torsion)

- Torsion

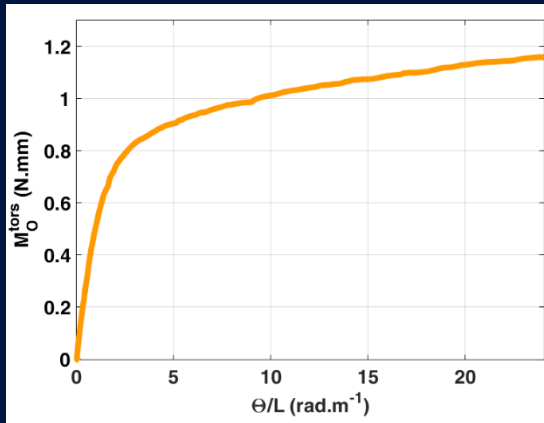

➤ Shear gradient

- Pure Bending

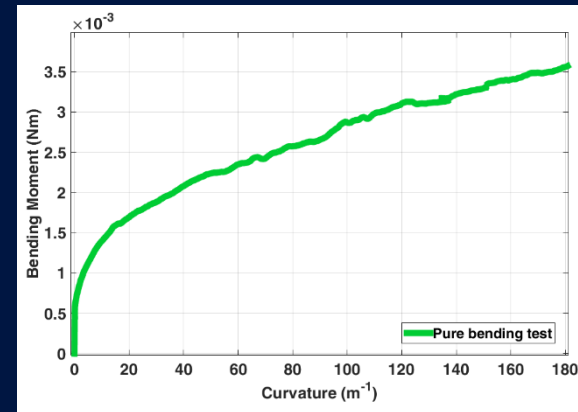

➤ Tensile to compressive gradient

Stress-strain behaviors

$$\sigma_{ij}(\epsilon_{ij}) = \sum_k q_k S_k(\epsilon_{ij})$$

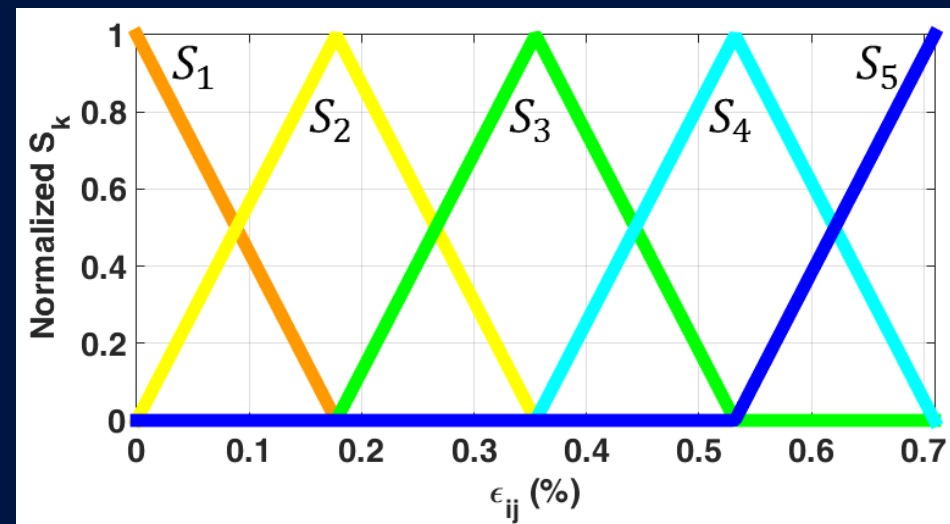

I. Extraction method (Torsion)

- Torsion

$$\epsilon_{r\theta} = r \frac{\theta}{L}$$

➤ Shear gradient

S_k Spline family

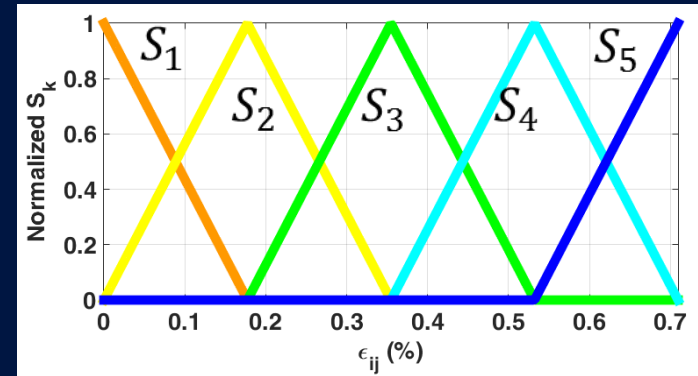

$$\sigma_{ij}(\epsilon_{ij}) = \sum_k q_k S_k(\epsilon_{ij})$$

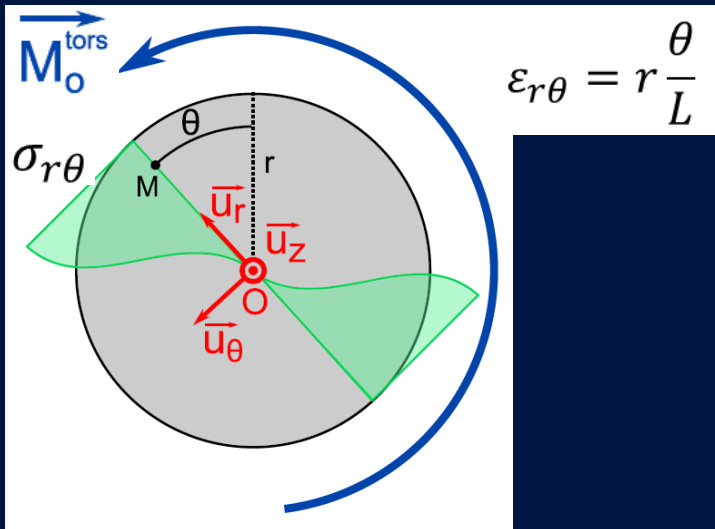

$$\epsilon_{r\theta} = r \frac{\theta}{L}$$

$$\overline{M_0^{tors}} = \int r \sigma_{r\theta} dS \vec{z}$$

$$\overline{M_0^{tors approx}} = \int_0^R r \sum_k q_k S_k(\epsilon_{r\theta}) 2\pi r dr \vec{z}$$

$$\overline{M_0^{tors approx}} = \sum_k q_k \int_0^R S_k(\epsilon_{r\theta}) 2\pi r^2 dr \vec{z} = \sum_k q_k U_k \vec{z}$$

I. Extraction method (Torsion)

- Torsion

$$\epsilon_{r\theta} = r \frac{\theta}{L}$$

➤ Shear gradient

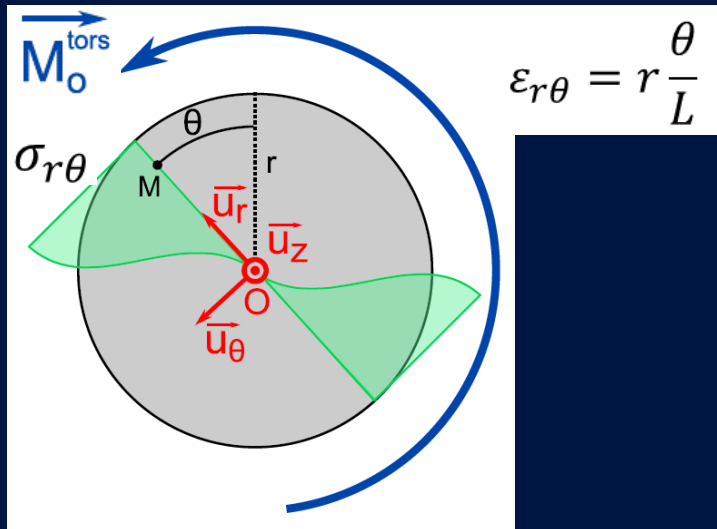

S_k Spline family

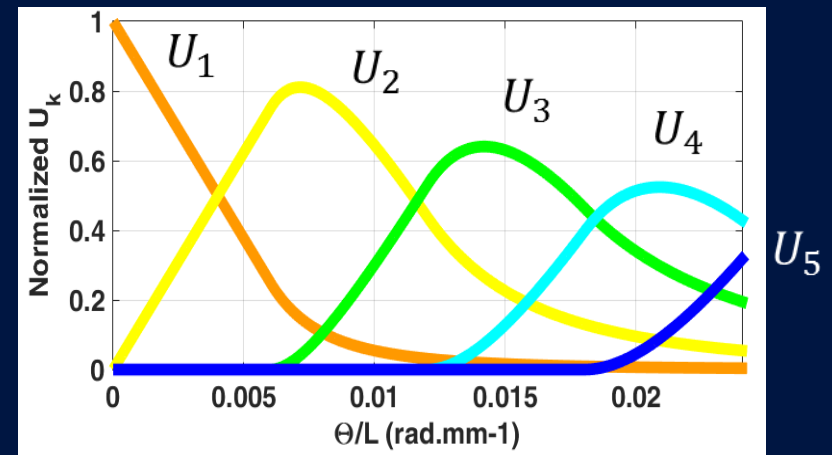
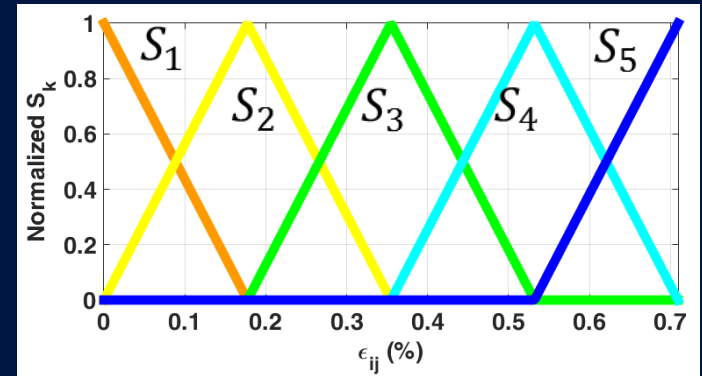

$$\vec{M}_0^{\text{tors approx}} = \sum_k q_k \int_0^R S_k(\epsilon_{r\theta}) 2\pi r^2 dr \vec{z} = \sum_k q_k U_k \vec{z}$$

I. Extraction method (Torsion)

- Torsion

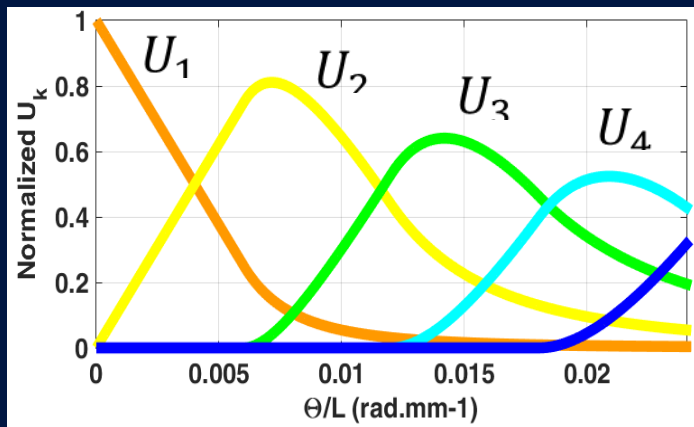
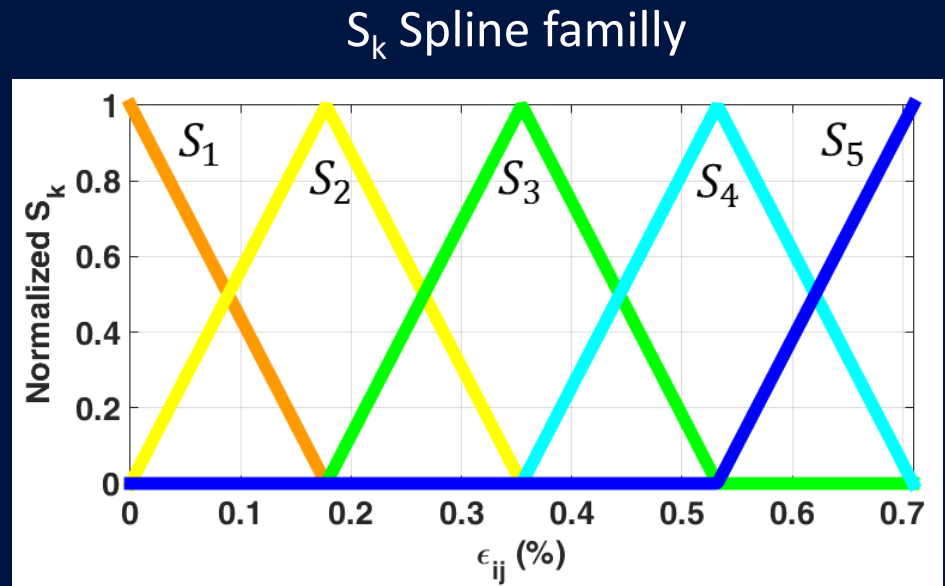
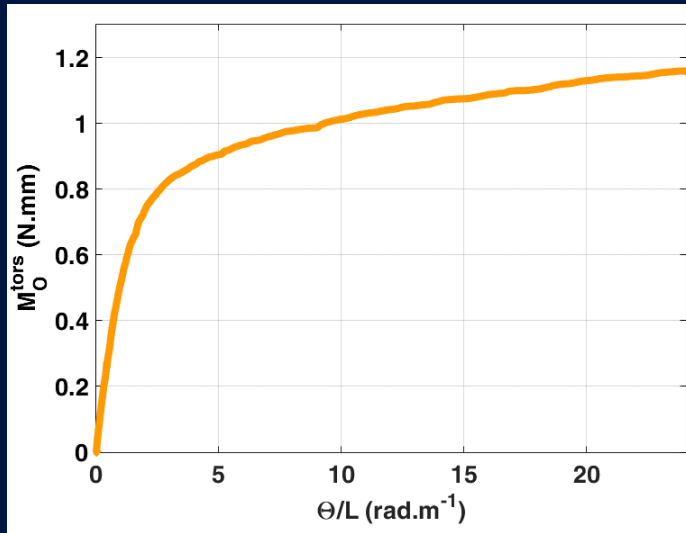

Minimize with conditions :

$$\phi^{tors}(q_k) = \sum_{p \text{ data points}} (M_0^{tors} - M_0^{tors \text{ approx}})^2$$

$$\overrightarrow{M_0^{tors \text{ approx}}} = \sum_k q_k U_k \vec{z}$$

Outline :

- I. Extraction method (**Torsion**)
- II. Application to experiments (**Torsion**)
- III. Application to experiments (**Bending**)
- IV. Conclusion

II. Application to experiments (**Torsion**)

- Torsion**

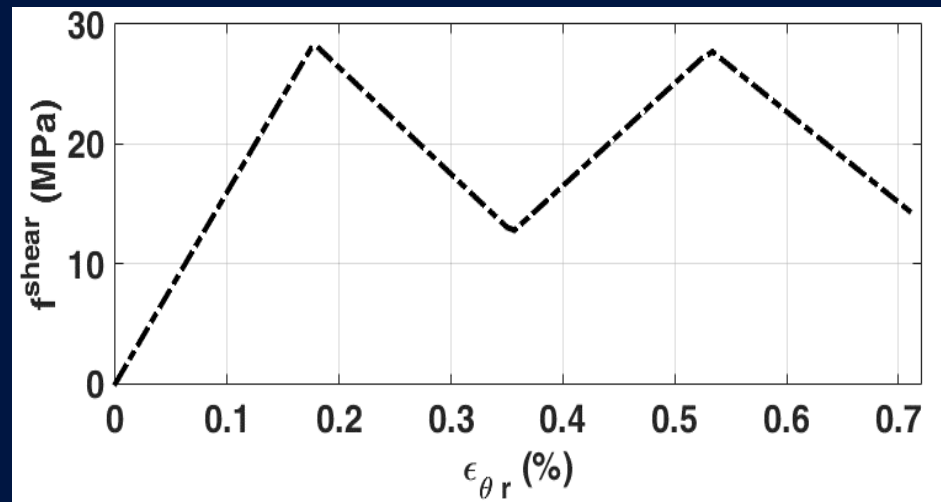
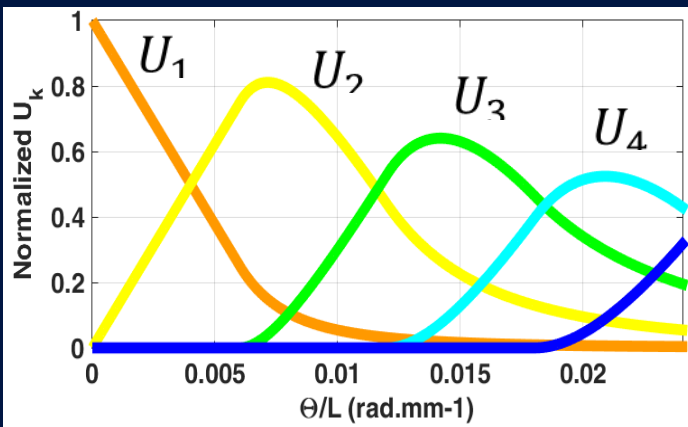
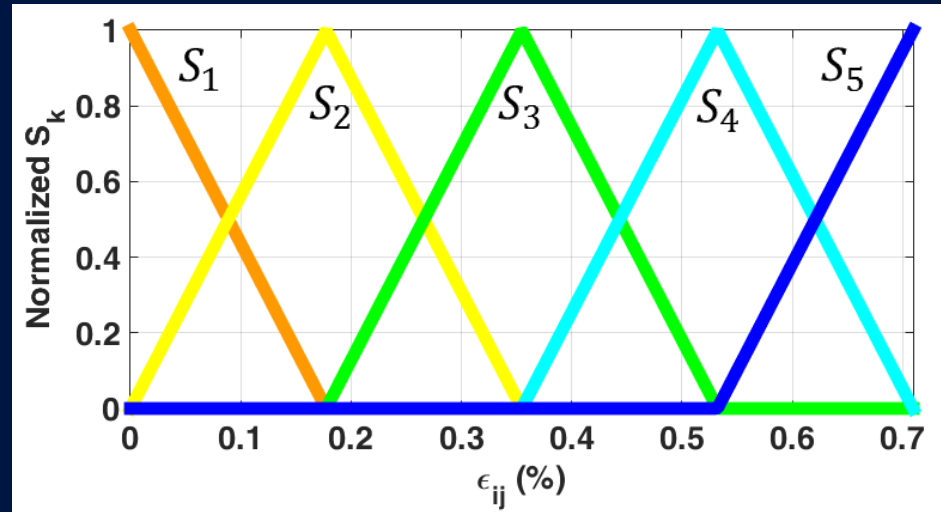
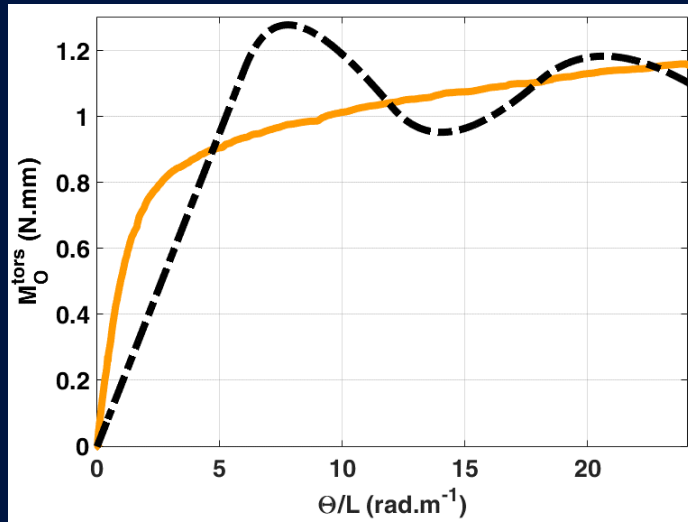

$$\overrightarrow{M_0^{tors approx}} = \sum_k q_k U_k \vec{z}$$

Identified Shear function

II. Application to experiments (**Torsion**)

- Torsion**

S_k Spline family (15)

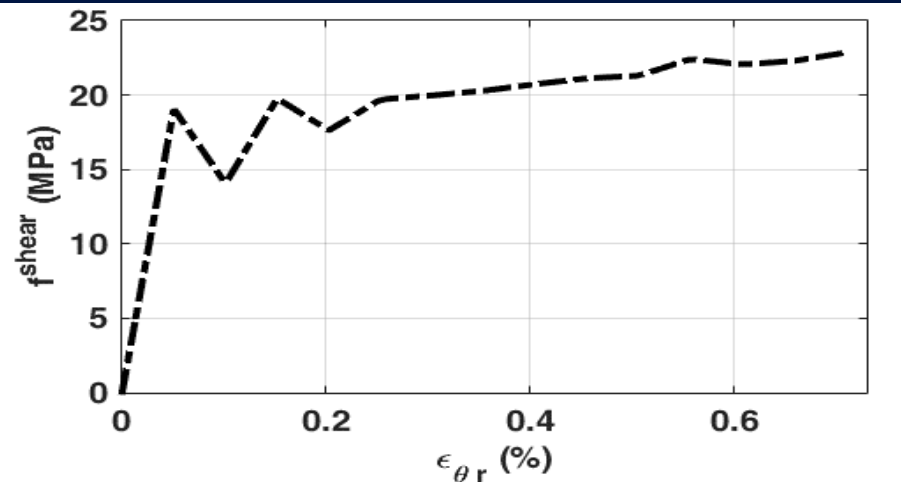
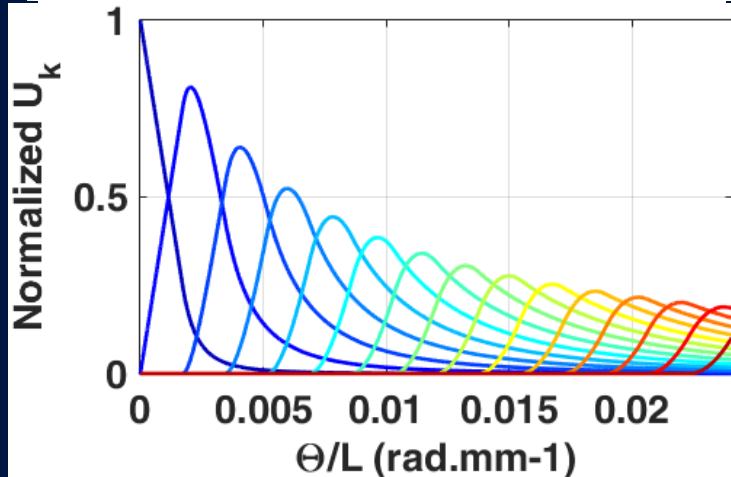
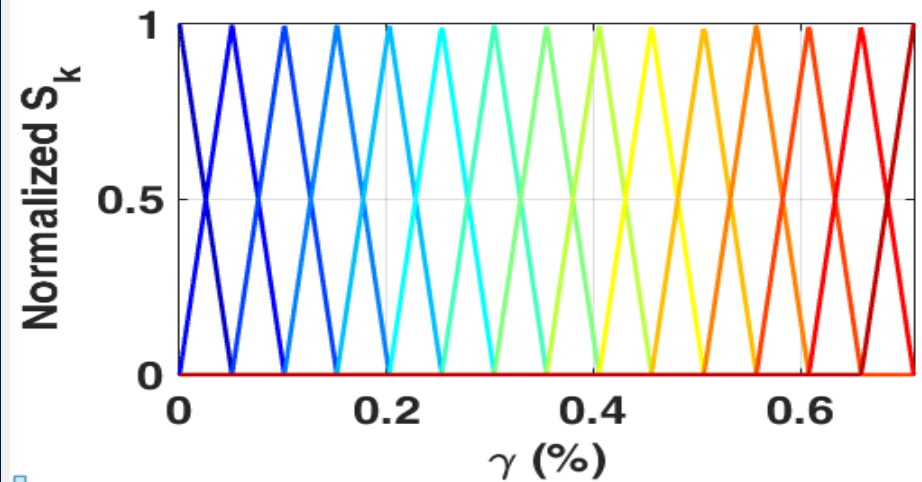
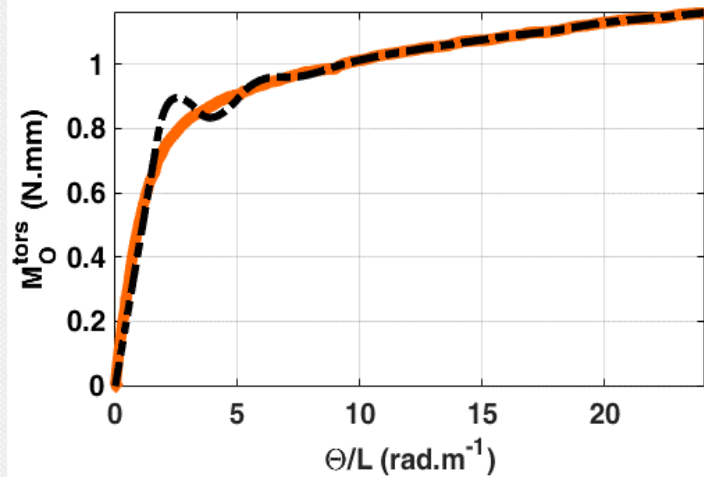

$$\overrightarrow{M_0^{\text{tors approx}}} = \sum_k q_k U_k \vec{z}$$

Identified Shear function

II. Application to experiments (**Torsion**)

- Torsion**

S_k Spline family (10)

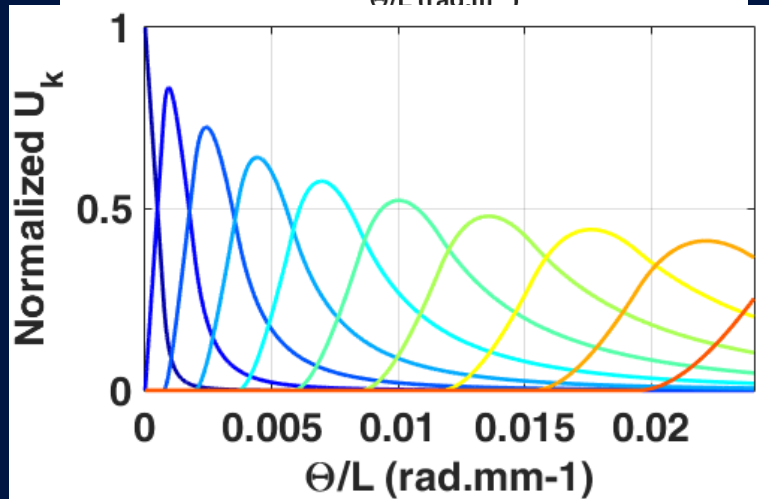
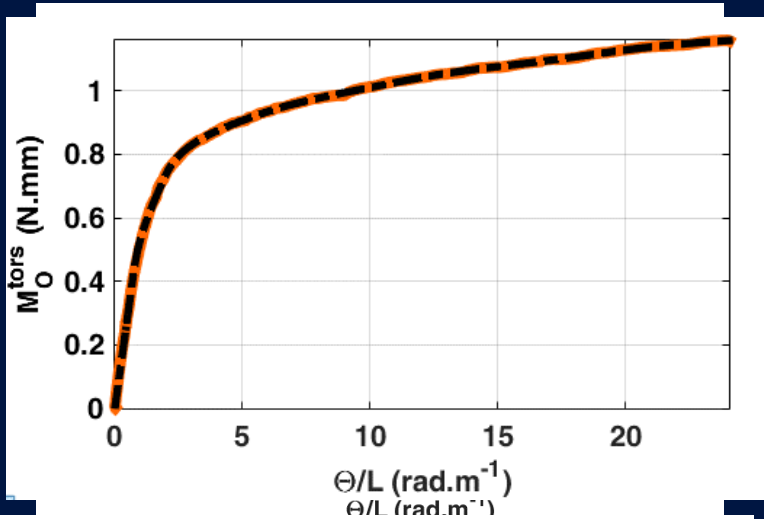

$$\overrightarrow{M_0^{tors approx}} = \sum_k q_k U_k \vec{z}$$

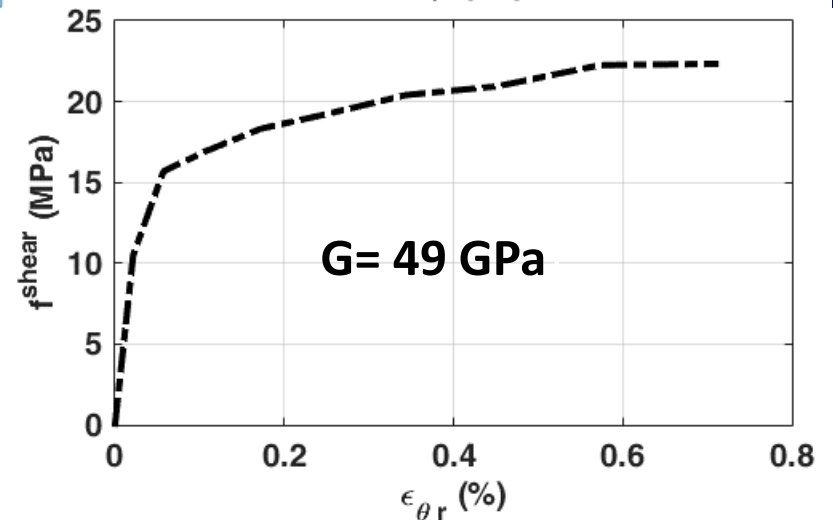
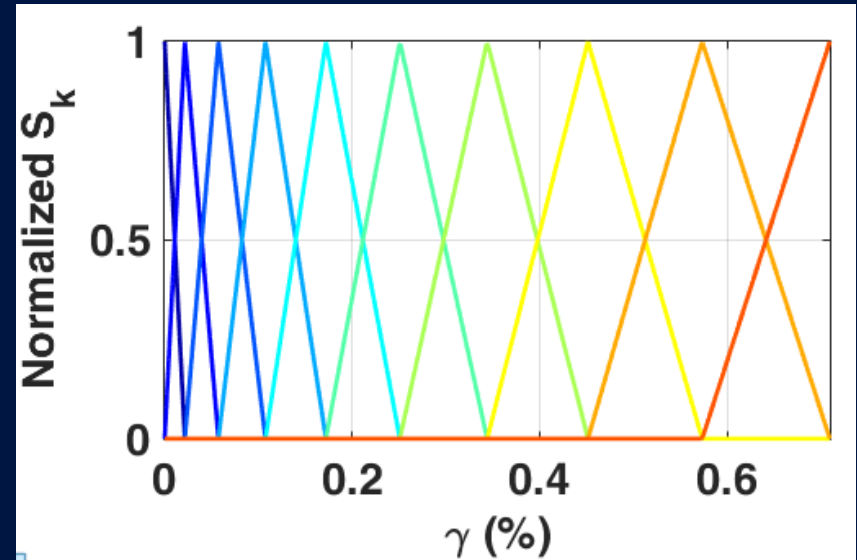

Identified Shear function

II. Application to experiments (Torsion)

- Torsion

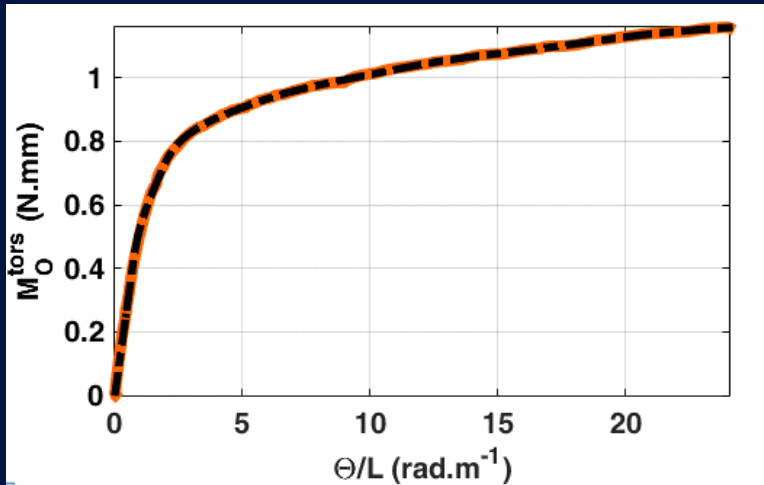

- ❖ S_k Base choice importance
- ❖ Criterion on the difference :

$$\text{Residual func} = M_0^{tors \text{ approx}} - M_0^{tors}$$

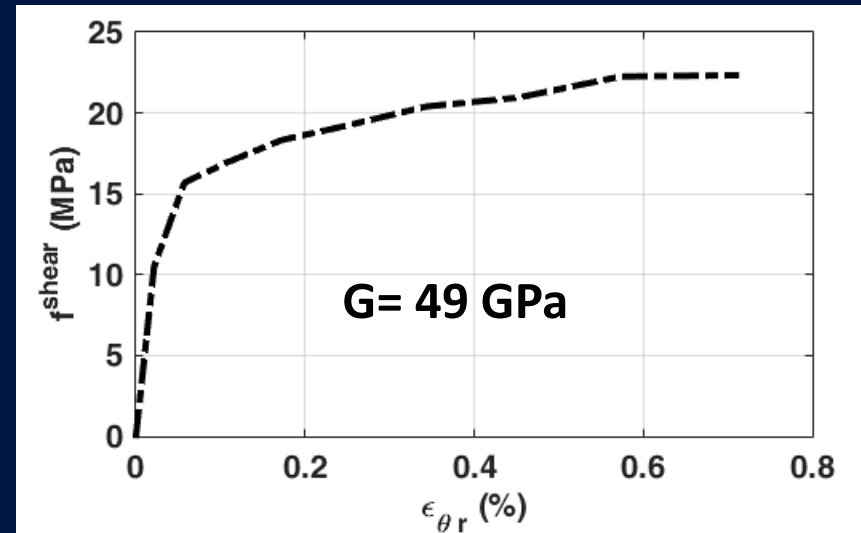

Identified Shear function

Outline :

- I. Extraction method (**Torsion**)
- II. Application to experiments (**Torsion**)
- III. Application to experiments (**Bending**)
- IV. Conclusion

III. Application to experiments (Bending)

- Pure Bending

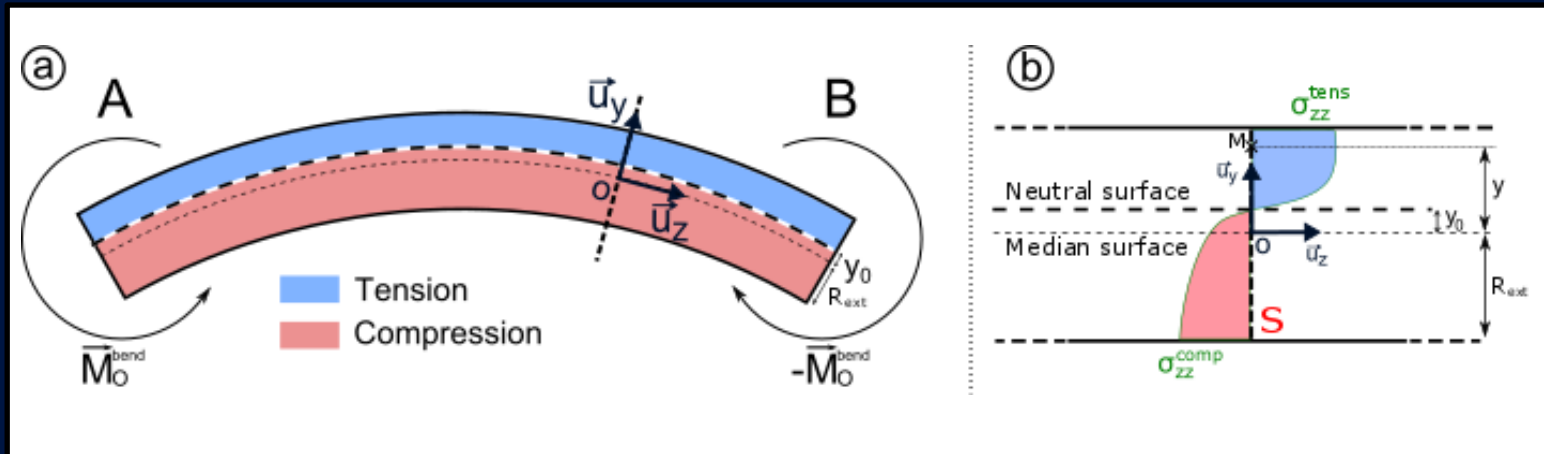

➤ Tensile to compressive gradient

$$\overrightarrow{M_0^{bend}} = \overrightarrow{M_0^{bend\ tens}} + \overrightarrow{M_0^{bend\ comp}}$$

$$\overrightarrow{M_0^{bend\ comp\ approx}} = \sum_k q_k U_k \vec{z}$$

$$\vec{0} = \overrightarrow{R_0^{tens}} + \overrightarrow{R_0^{comp}}$$

III. Application to experiments (Bending)

$$\vec{M}_0^{bend} = \vec{M}_0^{bend\ tens} + \vec{M}_0^{bend\ comp}$$

$$\vec{0} = \vec{R}_0^{tens} + \vec{R}_0^{comp}$$

NiTi
HT 250°C
D=0.5
mm

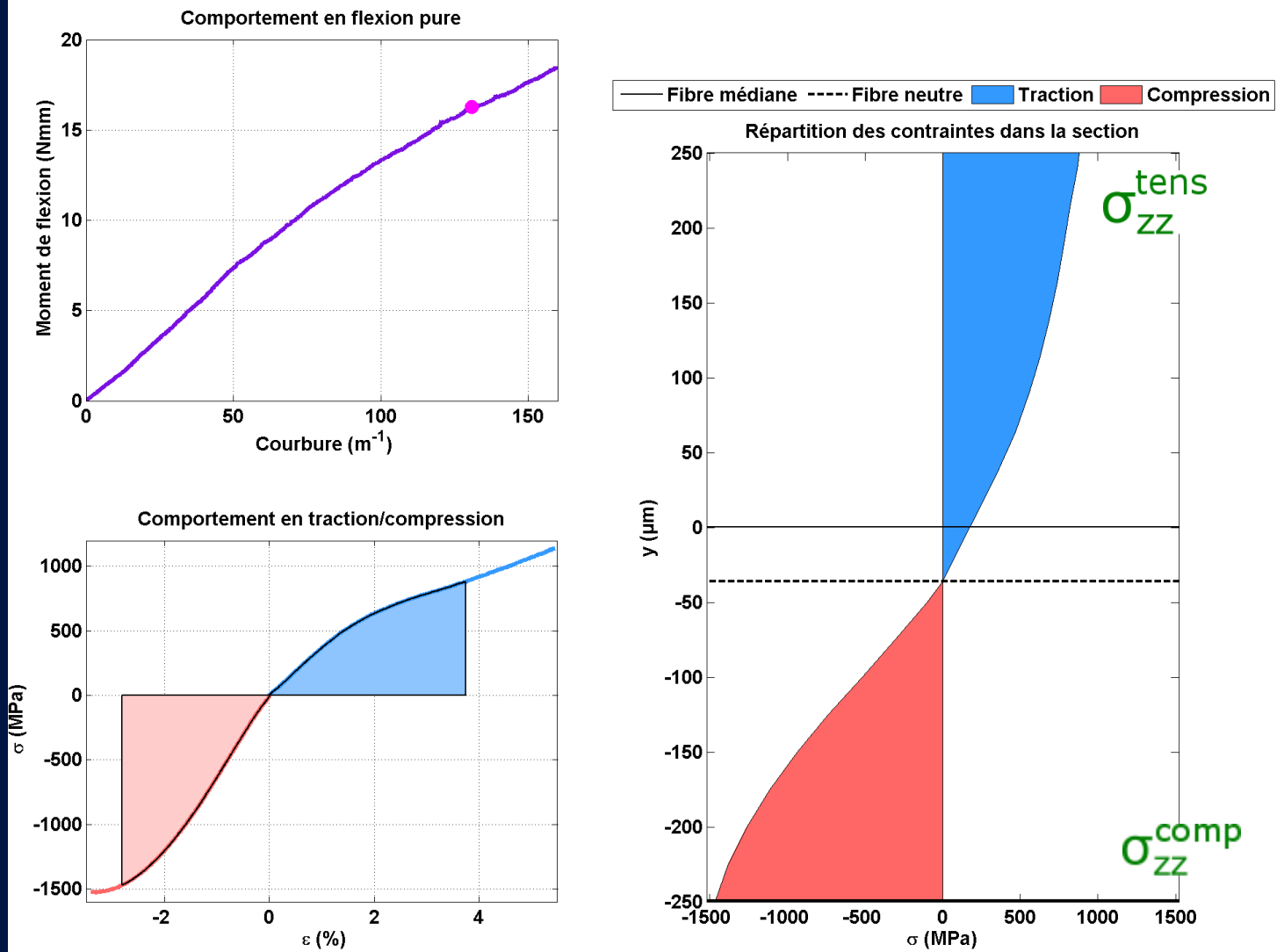

III. Application to experiments (Bending)

NiTi
HT 250°C
D=0.5
mm

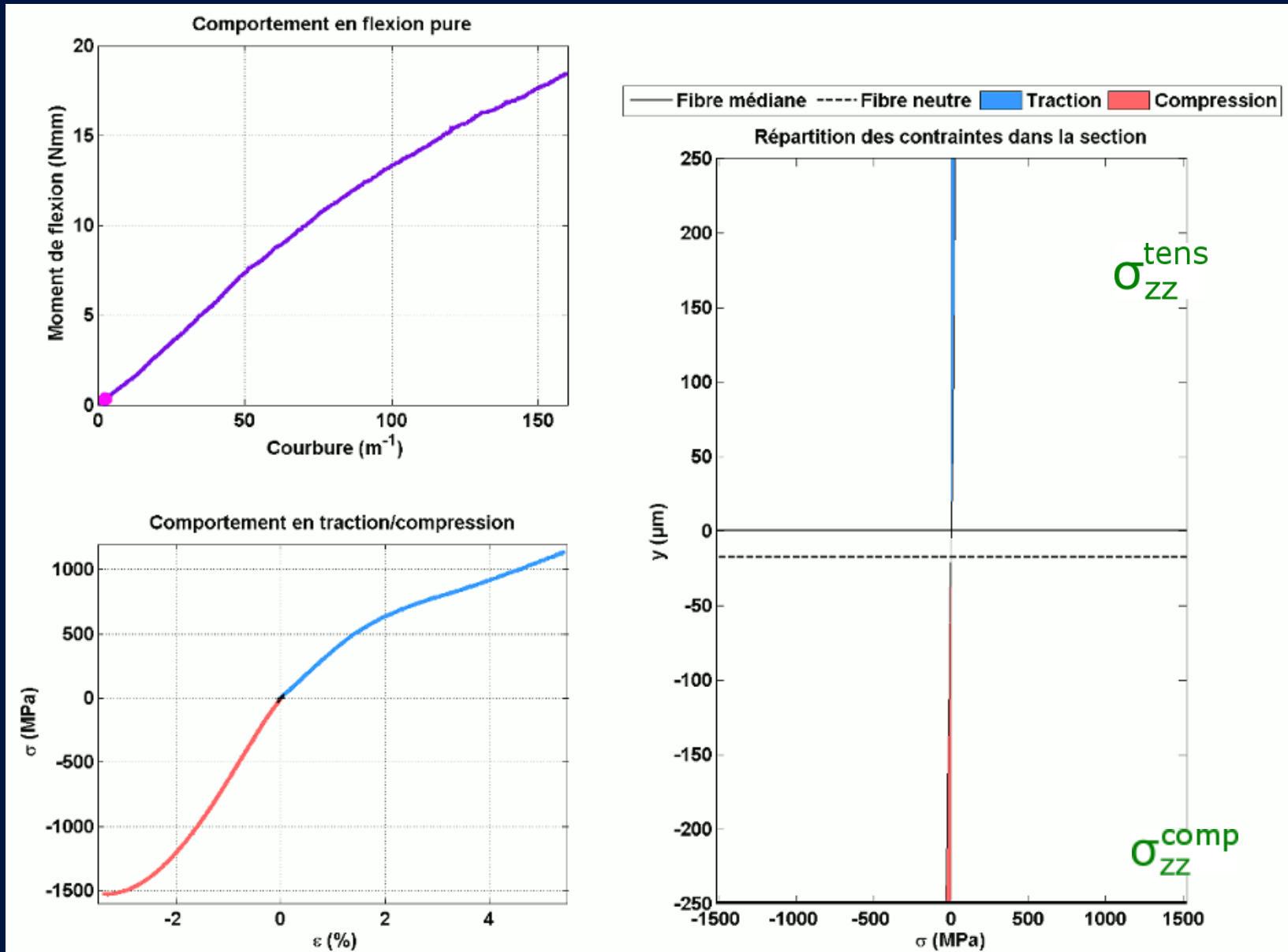

Copper wire (D=0.59 mm)

- **Bending**

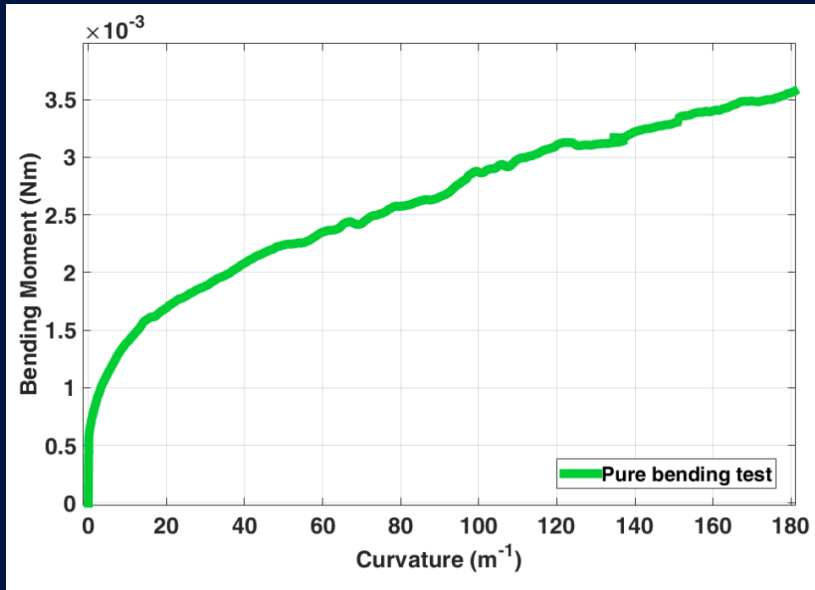

- **Tensile**

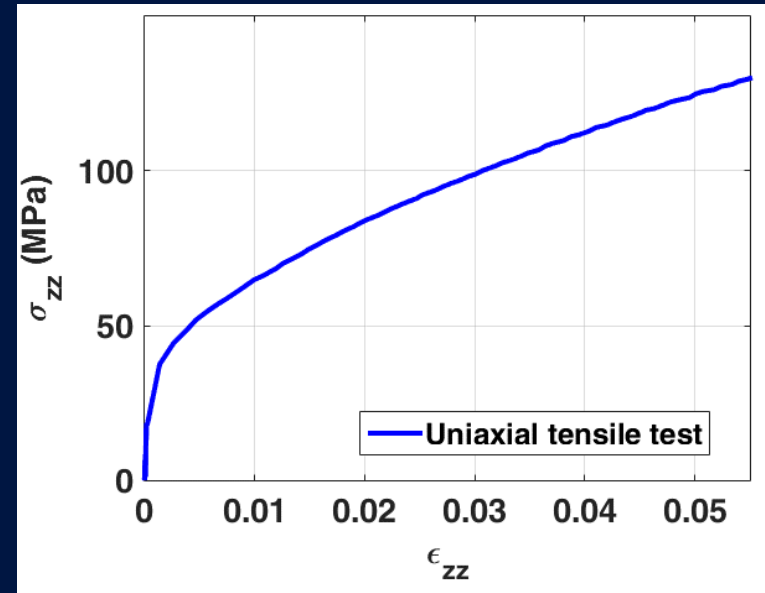

- **Compressive**

$$\sigma_{zz}(\epsilon_{zz}) = \sum_k q_k S_k(\epsilon_{zz})$$

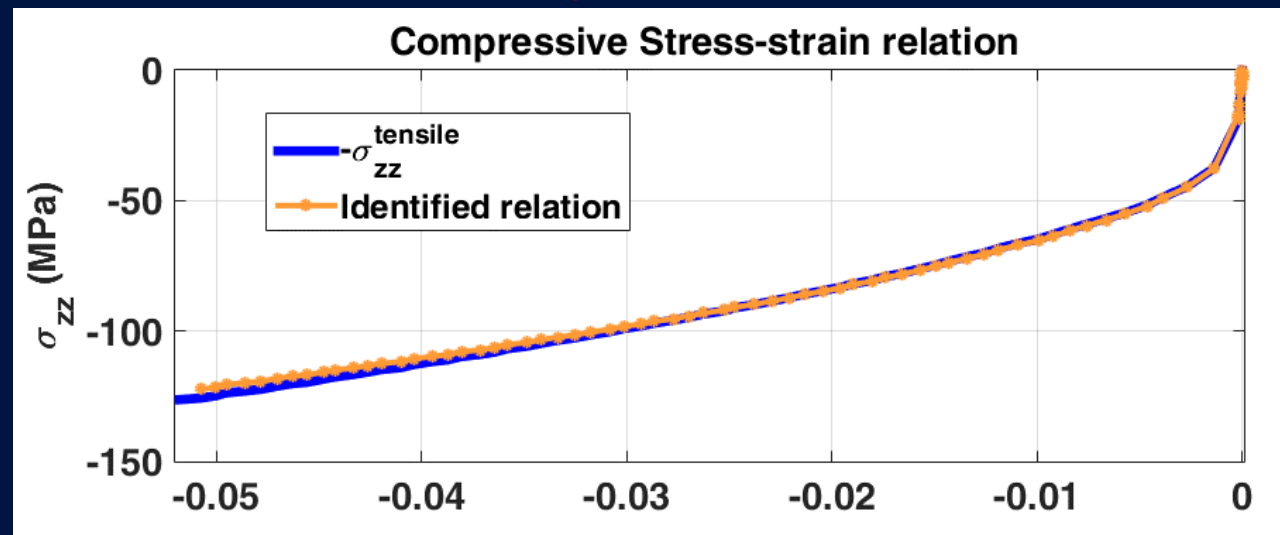

IV. Conclusion

- **Torsion**

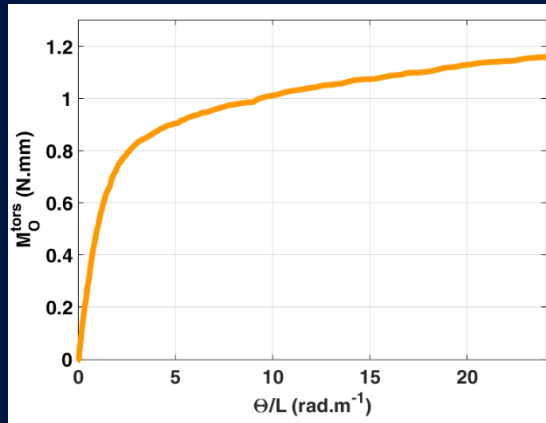

➤ Shear gradient

- **Pure Bending**

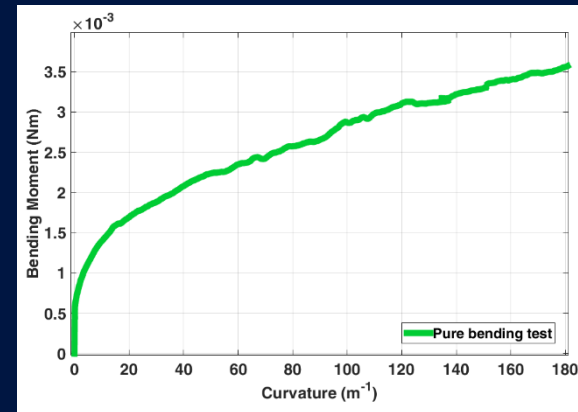

➤ Tensile to compressive gradient

Stress-strain behaviors

$$\sigma_{ij}(\varepsilon_{ij}) = \sum_k q_k S_k(\varepsilon_{ij})$$



III. Application to experiments (Bending)

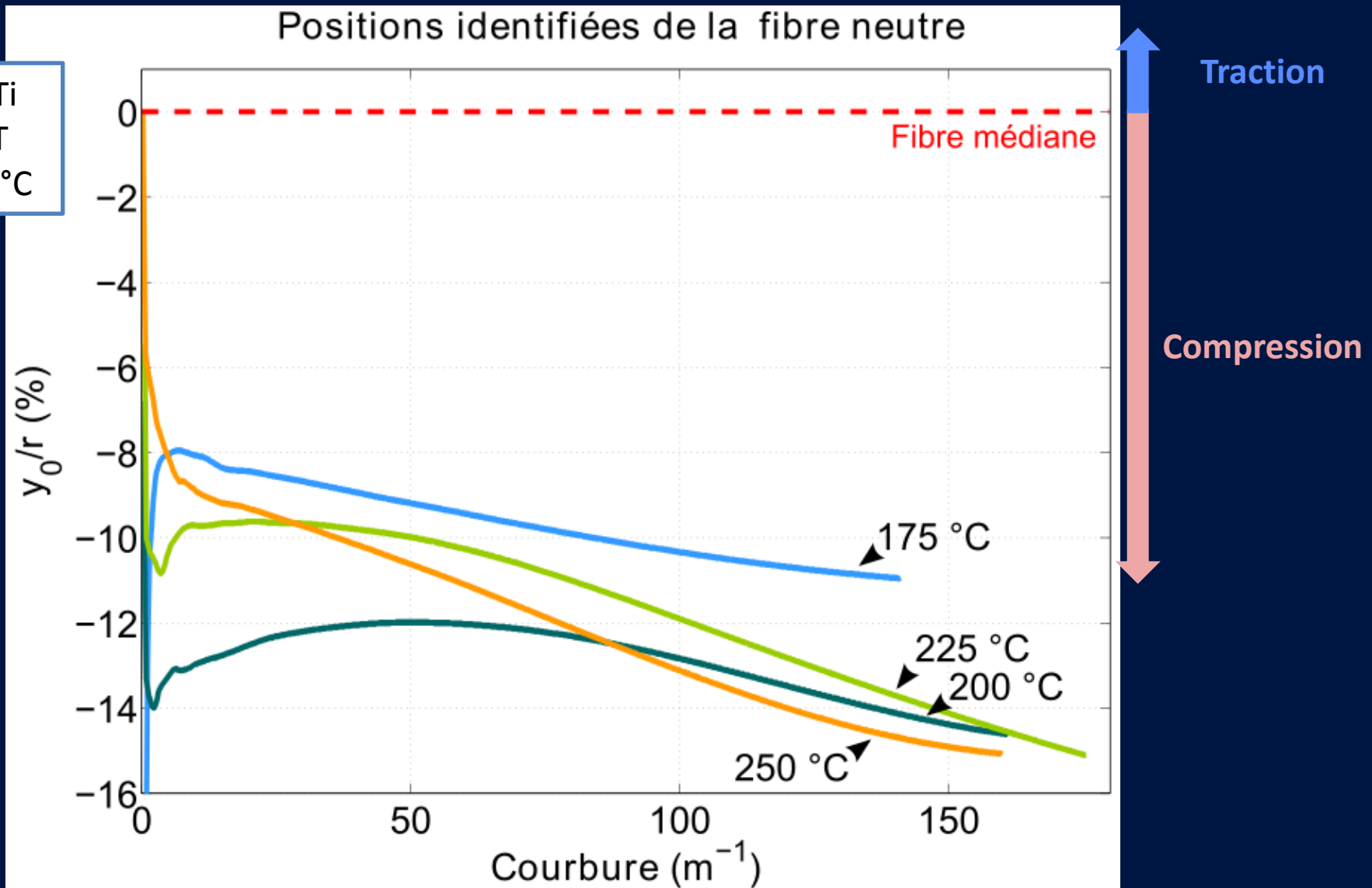

II. Application to experiments (Bending)

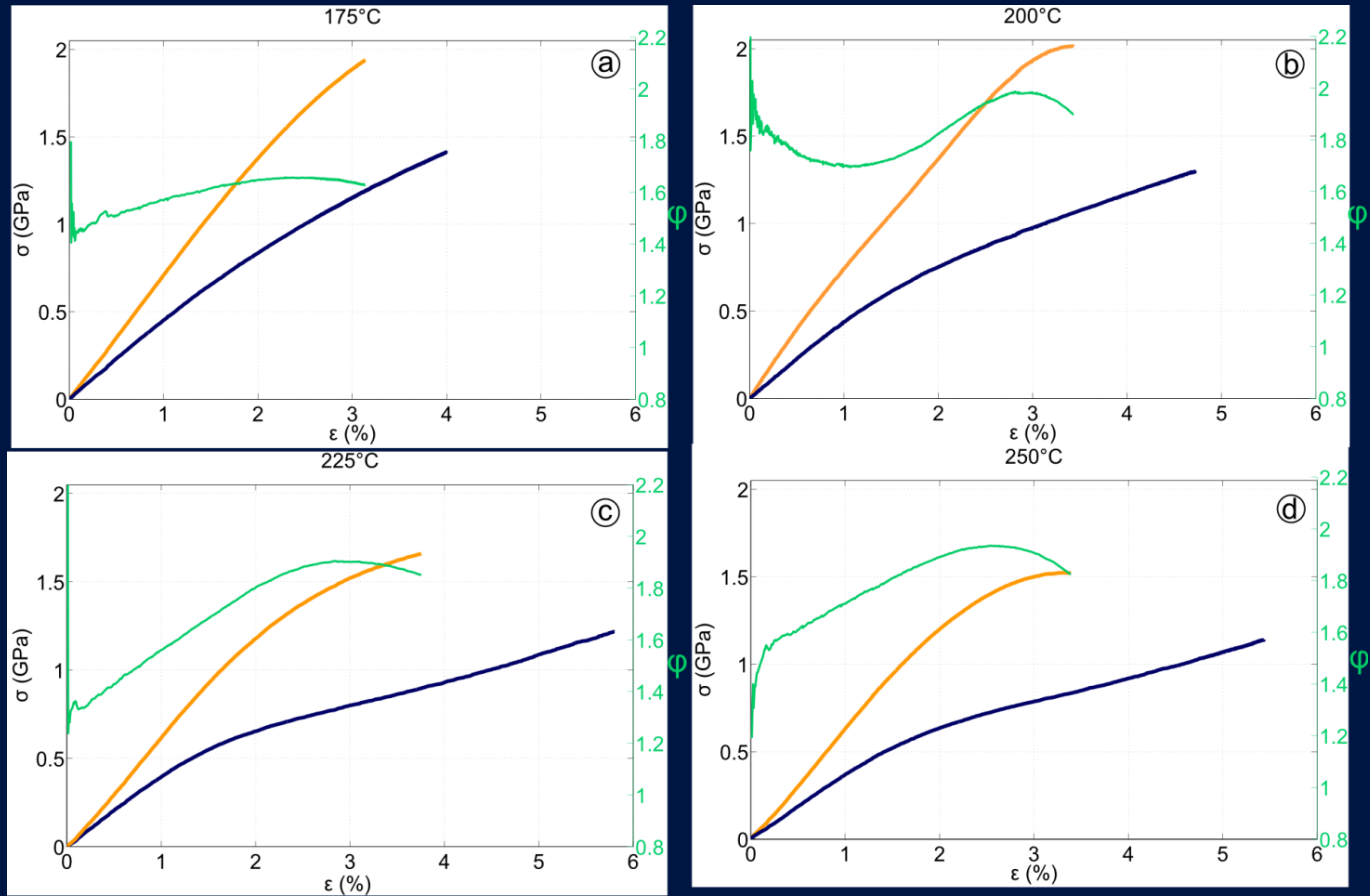

Introduction

- Pure Bending

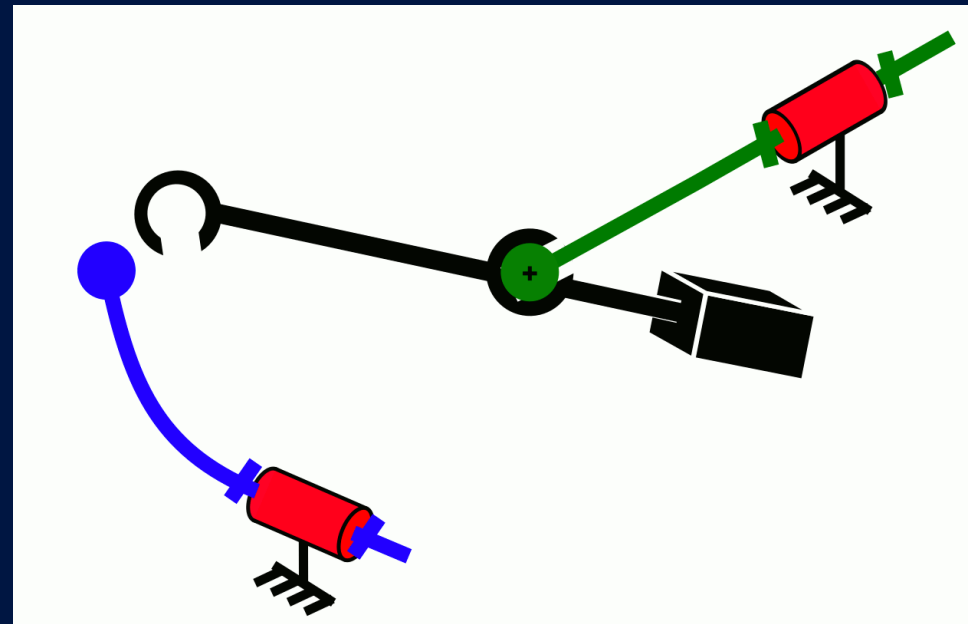

Introduction

- Pure Bending

