



**HAL**  
open science

## A Power Cycling Test Bench dedicated to the test of power modules in a large range of cycling frequency

François Forest, Jean-Jacques Huselstein, Guillaume Pellecuer, Serge Bontemps

### ► To cite this version:

François Forest, Jean-Jacques Huselstein, Guillaume Pellecuer, Serge Bontemps. A Power Cycling Test Bench dedicated to the test of power modules in a large range of cycling frequency. PCIM Europe 2017, International Exhibition and Conference for Power Electronics, Intelligent Motion, Renewable Energy and Energy Management, 2017, Nuremberg, Germany. hal-02005411

**HAL Id: hal-02005411**

**<https://hal.science/hal-02005411>**

Submitted on 19 Nov 2021

**HAL** is a multi-disciplinary open access archive for the deposit and dissemination of scientific research documents, whether they are published or not. The documents may come from teaching and research institutions in France or abroad, or from public or private research centers.

L'archive ouverte pluridisciplinaire **HAL**, est destinée au dépôt et à la diffusion de documents scientifiques de niveau recherche, publiés ou non, émanant des établissements d'enseignement et de recherche français ou étrangers, des laboratoires publics ou privés.

# A Power Cycling Test Bench dedicated to the test of power modules in a large range of cycling frequency

Francois Forest, Jean-Jacques Huselstein, Guillaume Pellecier  
INSTITUTE OF ELECTRONICS & SYSTEMS, Montpellier University, Place E. Bataillon, 34095 Montpellier, France.

Serge Bontemps  
MICROSEMI POWER MODULE PRODUCTS, 26 Rue de Campilleau, 33520 Bruges, France

## Abstract

This paper presents new developments of a power cycling test bench targeted to perform very high numbers of cycles at low  $\Delta T_J$  ( $>10^9$  cycles, 10 to 20°C). This test bench is based on operation of a bridge inverter in which the power devices are the modules to be tested and induces a power cycling of the power dies in realistic conditions (switching), with a high flexibility. This apparatus makes possible carrying out power cycling conventional tests (low frequency, 0.01Hz to 0.1Hz) as well as fast tests by using the temperature variation induced by a medium frequency (10Hz to 100Hz) load current adjusted by PWM modulation. The test bench is described briefly and the power cycling modes now available are illustrated by thermal measurements carried out on 1200V-75A IGBT modules with an IR camera. Finally, results of ageing tests at low temperature swing (10°C and 20°C) are presented.

## 1. Introduction

The test bench described in this paper was developed progressively to carry out power cycling tests in a large range of conditions. Initially, the aim was to realize classic power cycling tests in terms of frequency (0.01Hz to 0.1Hz) but in realistic conditions, i.e. the power semiconductor devices being placed in switching cells.

Then, the test bench has been improved to extend the range of power cycling conditions in order to stress more particularly the top part of the semiconductor dies including metallization and interconnections [1], with faster test protocols (power cycling frequency  $>1$ Hz). This way is obviously interesting to reduce the test duration.

But, at the same time, an important issue of this approach is the possible dependency of the ageing mode with the power cycling frequency, for given amplitude of the thermal stress. It is one of the main points of interest for the authors that collaborate with specialists of thermomechanics to correctly deal with this issue. It is not the subject of the paper but to put forward the interest in developing fast power cycling test methods, it is important to emphasize the expected repercussions:

– The first one, already mentioned above, is the reduction of the test duration. It seems possible to obtain temperature variations (noted  $\Delta T_J$  in the rest of the paper) on the junctions of few tens of degrees (30°C – 50°C) by using power cycling frequencies in the range [1Hz, 10Hz]. The lifetime associated to ageing mechanisms concerning the top part of the die in this temperature range then leads to test durations that can be estimated in days with such frequencies. In the assumption of likely industrial emergence of long lifetime connections, the increase of power cycling frequency becomes an essential advantage. Another positive consequence is the ability to apply lower  $\Delta T_J$  that should be more realistic in regard with the applications (particularly in transportation [2-3]).

– If this approach has been partially validated in [6], it had to be confirmed by comparative tests realized in a large frequency range to estimate the domain in which the ageing mechanisms are unchanged (work in progress). Even in the case of an analysis not completely convincing, results obtained with various power cycling frequencies will constitute precious data to support advanced thermomechanical studies.

The aim of these studies is a better understanding of the correlation between the ageing mechanisms of the die top part and the nature and level of temperature stresses. The final target is building models able to predict correctly the behavior of present and future connections.

In this context, the following presentation describes the test bench and its possible operating modes, and then gives some experimental results. They correspond to power cycling tests made with low temperature amplitudes that have been ordered by the manufacturer MICROSEMI.

## 2. Presentation of the test bench

The power cycling test bench described here has been already presented in [4-6]. The devices that can be tested are typically IGBT modules, including one to three inverter legs, with package size up to 130mm x 70mm. In the tests carried out for MICROSEMI and presented here, the package size is close to 70mm x 40mm (Fig. 1).

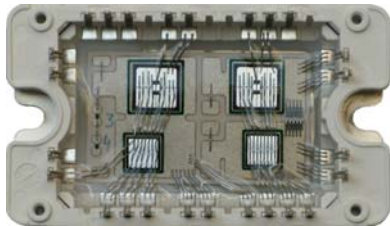

Fig. 1. View of the MICROSEMI package

### 2.1. Power stage

The samples are placed in a power electronic block to constitute a PWM bridge inverter (Fig. 2). Therefore, the ageing process is realized under switching conditions in order to be as close to real conditions as possible. The MICROSEMI IGBT module used here being an half-bridge module, the implementation of the inverter requires two modules. This inverter operates on an inductive load to minimize the power consumption during the test [4] and is controlled by a load-current closed loop that allows generating variable current shapes in load and, therefore, in the IGBT dies. These current shapes determine the conditions of the power cycling (see following section).

The IGBT modules are mounted on an air heat exchanger. In order to extract the thermal flux from the test room, this air-exchanger is placed in a closed chamber and is associated with an air-water exchanger coupled with fans.

The fan speed is controlled by a temperature regulation using a sensor glued on the exchanger between the two modules. At last, the liquid circulating in the air-water exchanger is cooled by a common chiller placed on the room roof and able to maintain a water temperature close to 20°C for a total heat flux of 10kW. The overall test bench includes six modular power stages. A general view of the facilities is given Fig. 3.

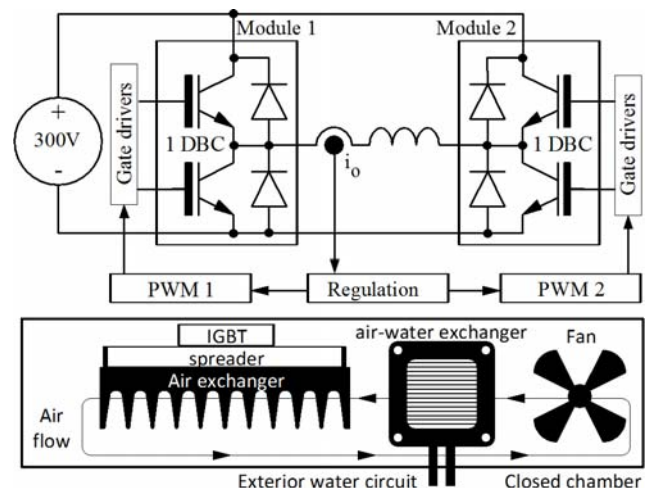

Fig. 2. Modular power stage

### 2.2. Control and supervision

A FPGA board is associated to each pair of blocks and constitutes the first control level. This board generates the PWM signals and realizes the closed-loop regulation of the inductive load current. It communicates with a PC dedicated to the supervision of the considered pair of blocks by mean of an acquisition board driven by a LabVIEW application. The control parameters of the power stages (switching frequency, power cycling frequency, load current shape) are adjusted on the LabVIEW window.

On the inverse way, all the parameter values measured on the power stages (currents, voltages, temperature) are transmitted to the LabVIEW application and are used to provide a real-time display for human supervision. In addition, the application manages the counting/memorization of the power cycle number and different protection functions as the stop of the power stage in case of undervoltage or in case of extended data transmission default.

The power stage includes short-circuit protections that are essential in a test bench where samples can be destroyed before detection of any characteristic evolution [5]. This short-circuit protection is first ensured locally by the gate drivers that transmit afterwards a default information to the FPGA board that stops immediately the concerned converter. This protection allows avoiding the default extension and making easier possible analysis about the default origin.



Fig. 3. View of the complete test bench

### 2.3. $V_{CE}$ and $T_J$ measurement

A complementary monitoring board can be connected to the power stage. The function of this additional board is the monitoring of  $V_{CE}$  voltage, for given values of current and junction temperature, in order to detect possible evolutions due to connection damage [5]. This measurement is very difficult to carry out: It needs to detect  $V_{CE}$  evolutions of few tens of mV on a total value comprised between 1V and 2V, across power devices integrated in an operating converter. In addition, this accurate measurement had to be made with the same fixed values of temperature and current throughout the test. The design of this monitoring board is presented in [6].

## 3. Power Cycling Range

Two main methods can be applied to generate power cycling on IGBT dies with the test bench. The first method consists of periodical turn-on and turn-off at low frequency (0.1Hz to 0.01Hz) of the inverter that operates in PWM mode during the turn-on phase. This method, used in [5], will not be detailed here.

The second method uses the temperature variations generated by a medium frequency modulation (1Hz to 100Hz) of the load-current [6]. Actually, this kind of fast power cycling can be encountered in any application of PWM inverter but induces in normal conditions low temperature variations that can be neglected. In the present method, the modulation effect is amplified by adjusting the power cycling parameters, particularly the current shape in the devices, to maximize the junction temperature swings while limiting electrical stresses and power consumption. The switching frequency is used as an additional adjustment parameter of the device losses and therefore of the power cycling profile.

The generation of an optimized current square wave, recently applied in the test bench, is the most efficient technique to minimize the average power consumption for given amplitude of the temperature swing. Fig. 5 shows an example of such a current waveform. The LabVIEW application allows adjusting the two parameters of this shape, i.e. the amplitude and the duration of the current pulses.

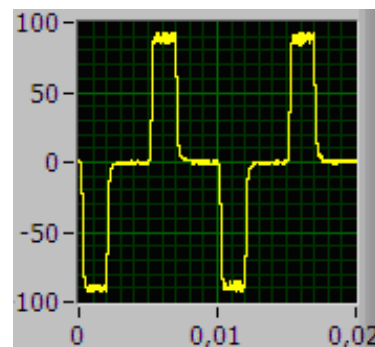

Fig. 4: Preferred current shape

Different measurements have been realized by the mean of an IR thermal camera (FLIR SC7000) to evaluate the junction temperature swing amplitudes in various conditions on the IGBT module MICROSEMI EE 2087A (1200V-75A) which is used in the tests presented below.

A sample has been opened, the silicone gel has been dissolved and a thickness-controlled coat (approximately 20 $\mu$ m) of black paint has been applied on the active zone.

A short camera integration time (200 $\mu$ s) allows avoiding low pass filtering effects on the thermal swing measurement up to 100Hz cycling frequency. The camera shutter speed is adjusted close to the cycling frequency to obtain a transposition of the capture frequency, e.g. 0.5Hz for 99.5 frames/s and 100Hz cycling frequency. This method improves strongly the measurement accuracy: For the previous example, 200 frames are captured to reconstitute the thermal cycle.

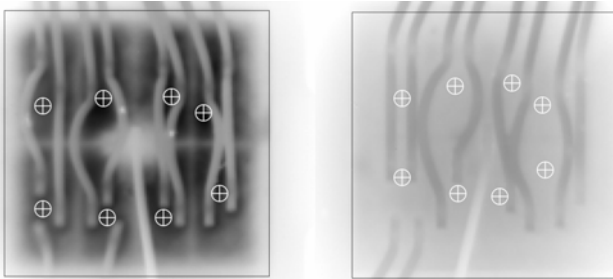

Fig. 5: Thermal camera measurement

The measurements are performed by acquiring eight surface temperatures on regularly spaced points of the two dies (Fig. 5). The estimated junction temperature is the average value of these different temperatures.

The Fig. 6 shows time-related evolution of this estimated temperature on a power cycle for three values of the power cycling frequency. The load current is according to Fig 4 (100A<sub>peak</sub>, 55A<sub>RMS</sub>).

- The others parameters are:
- switching frequency, 36kHz,
  - Supply voltage, 300V,

The total power losses in the IGBT bridge (2 modules), namely 4 IGBT dies, 4 diodes dies and the load-inductor, is close to 500W, the estimated value of losses in each IGBT being close to 90W. It can be observed that electrical stresses applied to the modules to obtain the desired power cycling conditions stay in a standard range, considering the module characteristics.

With this load-current shape, the amplitudes of the junction temperature swings are very significant for power cycling frequency values of few tens of Hz. On the Fig. 6, It can be observed that a variation of 30°C is obtained for a power cycling frequency of 25Hz, that leads to generate 2 10<sup>6</sup> cycles by day.

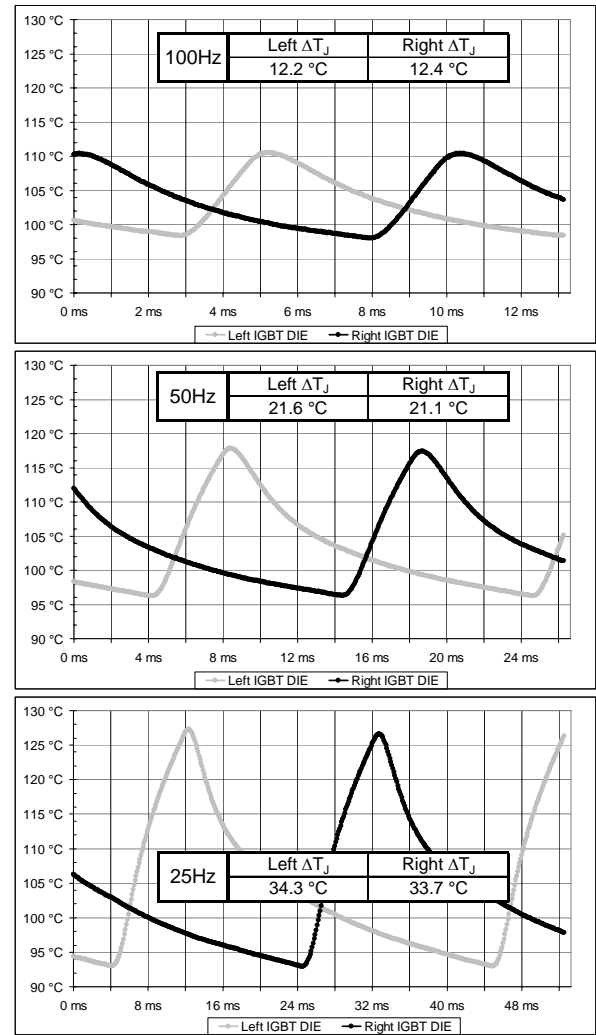

Fig. 6: Temperature swings vs cycling frequency

### 3. Experimental Results

The tests made for MICROSEMI are very specific because the manufacturer wished results concerning low temperature power cycling, i.e. 10°C and 20°C, generated by PWM modulation in inverters, with the target to reach the billion of cycles and more.

Such tests are interesting to obtain complementary experimental data in an unexplored power cycling domain and to complete results of previous studies. Therefore, some results obtained by authors are recalled here to place the new tests in a more general context. The test bench described above has been used to carry out various power cycling tests, generating temperature swing amplitude from 30° to 100°C. The recent works are focused on lower temperatures that are more realistic in regard with applications.



This positioning requires increasing the power cycling frequency to minimize the test duration. Different results accumulated in the 30°C–100°C temperature range, on IGBT modules with similar technology, are summarized on the lifetime curves of Fig. 7.

The ageing modes observed are very different between the two ends of the considered range of power cycling temperature [5][6]. For the 60°C – 100°C temperature range, the test bench was controlled in on/off mode at low frequency. For the 30°C – 50°C temperature range, the fast method (PWM modulation) was used.

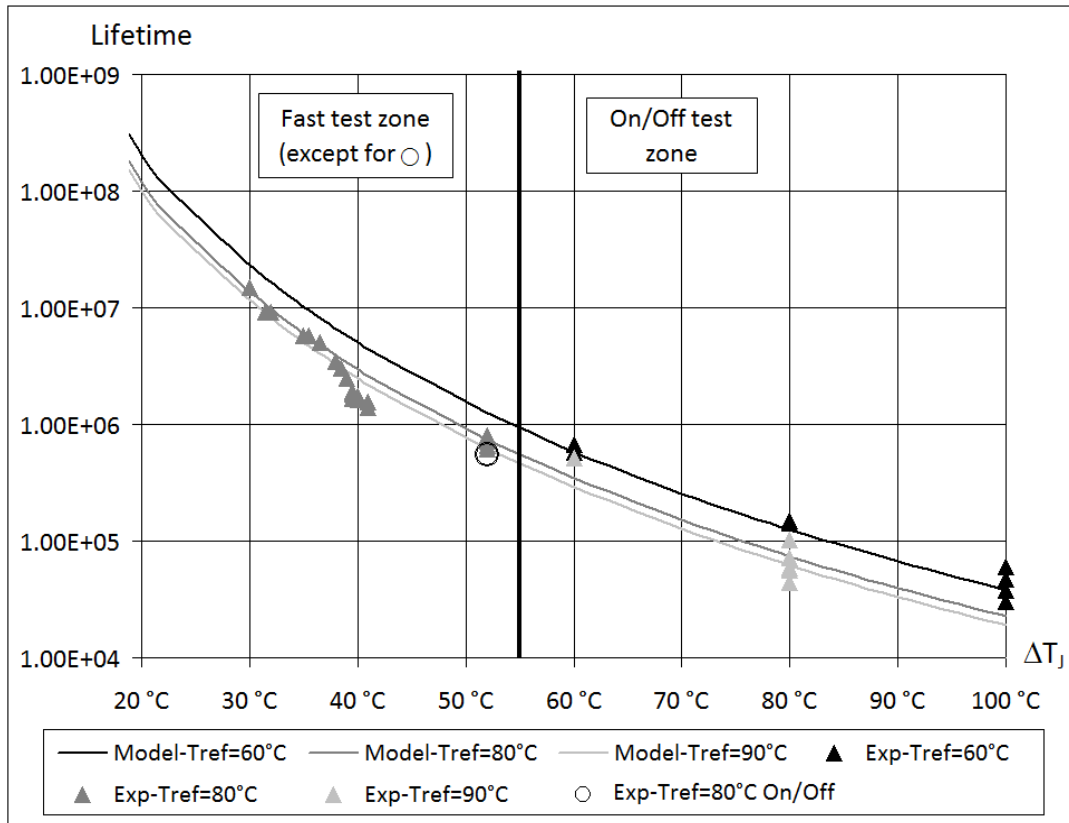

Fig. 7: Different power cycling results obtained in the 30°C – 100°C range

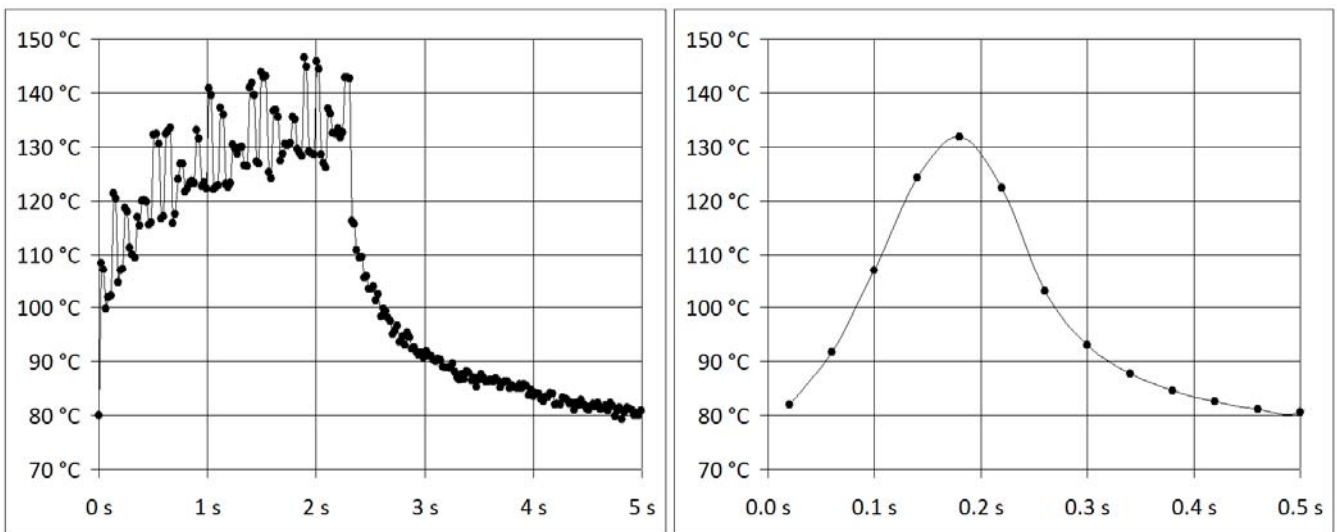

Fig. 8: Shape of temperature swings to evaluate effect of power cycling frequency

In this second zone, the ageing mode is always the same, i.e. damage of wire-bond attaches with regular lift-off.

In the previous sections, the issue of the power cycling frequency influence has been mentioned. A partial experimental analysis has been conducted on this point. The Fig. 8 shows two different temperature swing profiles that have been implemented to evaluate the effect of the frequency.

The first profile corresponds to an on/off test at 0.2Hz; the second profile corresponds to a modulation frequency of 2Hz, the temperature swing amplitude being the same. The lifetime is very similar in both case (close to  $7 \cdot 10^5$  cycles). This first comparison has been made with a too low number of samples for the on/off mode to be entirely convincing: An additional work, on a larger frequency range, is currently in progress to complete the analysis. Nevertheless, this first observation is promising as for the validity of the fast method.

Therefore, the tests made for MICROSEMI are very different because the temperature swing amplitudes are lower and the power cycling frequencies much higher.

Ten samples were tested or are still under test. Six samples have been placed in the 100Hz – 10°C power cycling conditions of Fig. 6, and the four others in 50Hz - 20°C conditions. All the samples have been previously characterized by the mean of a power devices analyzer, with among others, a  $V_{CE}$  measurement at 20A and 25°C. The following table summaries the progress of these tests.

	10 <sup>9</sup> Cycles	2 10 <sup>9</sup> Cycles	3 10 <sup>9</sup> Cycles
$\Delta T_J = 10^\circ\text{C}$ 100Hz	2 samples 20mV $V_{CE}$ increase	2 samples 30mV $V_{CE}$ increase	2 samples Test still in progress
$\Delta T_J = 20^\circ\text{C}$ 50Hz	2 samples 20mV $V_{CE}$ increase	2 samples Test still in progress	

Table 1: progress of the tests

The aim of MICROSEMI being to verify the module behavior for cycle numbers higher than  $10^9$ , the three pairs of modules dedicated to the 100Hz - 10°C protocol have been assigned to three different expected cycle numbers,  $10^9$ ,  $2 \cdot 10^9$  and  $3 \cdot 10^9$ . The tests on the four other modules (50Hz – 20°C) have been added in the hope to obtain faster some damages.

The tests are ended for six samples that have been characterized again on the power device analyzer in the same conditions. In all cases, a significant increase of the voltage  $V_{CE}$  (20A – 25°C), comprised between 20mV and 30mV, has been measured. Then, the wire-bond attaches have been observed with a SEM, but no damage similar to those of previous studies has been detected. More detailed analysis has to be made to identify the possible reasons of the  $V_{CE}$  increase in these specific tests.

## 4. Conclusion

In this paper, an original power cycling test bench is presented that offers various possibilities to carry on power cycling tests on small power semiconductor modules. A fast test method, using the thermal effect generated by a PWM modulation, has been implemented. Therefore, power cycling tests in high frequency – Low temperature ranges are now reachable.

These characteristics are used here to test IGBT modules under low temperature stresses at high power cycling frequency. The preliminary results show an evolution of the  $V_{CE}$  after one billion of cycles but the corresponding physical damage has not yet been identified.

## References

- [1] M. Ciappa, "Selected failure mechanisms of modern power modules", *Microelectronics Reliability*, Vol 42, No. 4-5, pp. 653–667, 2002
- [2] M. Thoben, K. Mainka, R. Bayerer, I. Graf, M. Münzer, "From vehicle drive cycle to reliability testing of Power Modules for hybrid vehicle inverter", *PCIM* 2008.
- [3] U. Scheuermann, R. Schmidt, "Impact of load pulse duration on power cycling lifetime of Al wire bonds", *Microelectronics Reliability*, Vol 53, pp. 1687-1691, 2013.
- [4] F. Forest, J.-J. Huselstein, S. Faucher, M. Elghazouani, P. Ladoux, T. Meynard, C. Turpin, J. Vallon, "Use of the Opposition Method in the Test of High Power Electronics Converters", *IEEE Transactions on Industrial Electronics*, Vol. 53, N°2, pp. 530-541, April 2006.
- [5] V. Smet, F. Forest, J.-J. Huselstein, F. Richardeau, Z. Khatir, S. Lefebvre, M. Berkani, "Ageing and Failure Modes of IGBT Modules in High Temperature Power Cycling", *IEEE transactions on industrial electronics*, Vol. 58, N°10, pp. 4931-4941, October 2011.

[6] F. Forest, A. Rashed, J.-J. Huselstein, T. Martiré, P. Enrici, "Fast Power Cycling Protocols Implemented in an Automated Test Bench Dedicated to IGBT Module Ageing", *Microelectronics Reliability*, Vol. 55, pp. 81-92, 2015.