



**HAL**  
open science

## Design and evaluation of a smart insole: Application for continuous monitoring of frail people at home

Yoann Charlon, Eric Campo, Damien Brulin

### ► To cite this version:

Yoann Charlon, Eric Campo, Damien Brulin. Design and evaluation of a smart insole: Application for continuous monitoring of frail people at home. *Expert Systems with Applications*, 2018, 95, pp.57-71. 10.1016/j.eswa.2017.11.024 . hal-01997248

**HAL Id: hal-01997248**

**<https://hal.science/hal-01997248>**

Submitted on 28 Aug 2023

**HAL** is a multi-disciplinary open access archive for the deposit and dissemination of scientific research documents, whether they are published or not. The documents may come from teaching and research institutions in France or abroad, or from public or private research centers.

L'archive ouverte pluridisciplinaire **HAL**, est destinée au dépôt et à la diffusion de documents scientifiques de niveau recherche, publiés ou non, émanant des établissements d'enseignement et de recherche français ou étrangers, des laboratoires publics ou privés.

## Design and evaluation of a smart insole: application for continuous monitoring of frail people at home

### Abstract

The objectives of this work are to develop a technological solution designed to support active aging of frail older individuals and to conduct a first evaluation of the devices. We wish to bring a reflection in the field of connected health by setting up a remote medical follow-up. In this context, the connected object presented in this article aims at implementing a longitudinal follow-up of the walk by a health professional. Continuous remote data analysis applies behavior learning methods by modeling walking habits and allows the detection of deviations by application of thresholds defined by the expert. We propose an instrumented shoe insole to provide such monitoring (number of steps, distance covered and gait speed). In this perspective, we designed a low power microelectronic device integrated into the thickness of an insole in order to demonstrate the technical feasibility of such a device in laboratory and in living conditions. The project called "FOOT-TEST" is funded by the DIRECCTE of the Midi-Pyrenees Region in France. This project brought together a manufacturer who specializes in the design of foot-care systems, geriatricians and our laboratory specialized in electronics to propose a technical solution adapted to frail individuals. Two smart insole prototypes have been produced and a first evaluation of the smart insole in real use conditions has been performed. According to user feedback, the smart insole seems to be much easier to use than commercial connected pedometers. Moreover, in terms of performance, the smart insole provides better results. In this paper, we present specifications of the device, technological choices and the design of two versions of the smart insole, methods used to measure desired settings, a first evaluation of the system and, finally, preliminary conclusions and work in progress.

**Keywords:** Connected object, smart insole, monitoring system, gait parameters, frail people, support active aging.

### 1. Introduction

The recent development in the area of Internet of Things and the launch in many countries of economical and political programs about "silver economy" enable first of all general practitioners or geriatricians to reconsider the way they monitor their patients and then patients to be actors of their health. We wish to bring a reflection in the field of connected health by setting up a remote medical follow-up that supplies further information to the health professional in order to make the decision easier. In this context, the connected object presented in this article aims at implementing a distant follow-up of the walk by a health professional and supporting active aging of frail older individuals as walking speed is more and more considered as the 6<sup>th</sup> vital sign.

An aging population has emerged as a major societal issue. Generally, activity measurement is used as an indicator of elderly health. Recent studies on the causes of disability point to frailty as a specific precursor (Van Kan et al., 2008). In France, follow-up of frail people is performed periodically during hospital visits and by phone every three months. Fried et al. criteria (Fried, Ferrucci, Darer, Williamson, & Anderson, 2004) are most commonly used by the medical community to identify frail subjects: slow gait speed, less muscle strength, exhaustion, sedentariness, and involuntary weight loss. Several studies show that walking speed is the most predictive criterion of disability (Cesari et al., 2005; Montero-Odasso et al., 2005). Frailty is potentially reversible (Pahor et al., 2006), and a number of healthy lifestyle interventions now can be proposed, such as a gait program (Pahor et al., 2006; Nelson et al., 2004; Daniels, Rossum, Witte, Kempen, & Heuvel, 2008).

The use of technology could be relevant to support active aging and evaluate frailty (Fontecha et al., 2013), as well as for promoting and monitoring exercise at home (Makai et al., 2014). Remote exercise interventions managed via a telecommunications system at home seem to be efficient (Van Het Reve et al., 2014), and remote feedback in home-based physical activity interventions seems to be as effective as supervised exercise interventions (Sparrow et al., 2011). Monitoring could potentially improve adherence and performances (Yamada et al., 2012). Commercial connected objects are already proposed to young robust people to encourage them to practice sport. By contrast, in current clinical practice, no connected devices are used to measure activity and gait speed and give feedback to the patient. In fact, remote follow-up of frail elderly patients is almost

nonexistent. However, to reach our goal we need to make more accurate measurements, especially concerning gait speed, and to make it less obtrusive for the end users. Given the importance of the relationship between gait speed at usual pace and risk of adverse events, and because of the amount of change for a 0.1 m/s variation (Abellan van Kan et al, 2009), we are seeking 0.1 m/s accuracy (accuracy greater than 95% for 1 m/s), which is not provided by commercial devices and mobile phones. In addition, to ensure long-term acceptability it is important to develop a discreet, transparent, and self-reliable device. Practically, this means that there should be no need for direct human intervention in data transmission and battery charging. That is far from being the case with commercial devices and mobile phones delivered today.

We believe that there is a specific need for the development of a patient-centered device that provides accurate and unobtrusive assessment of physical activity and gait speed, as well as intervention adherence through feedback and self-motivation. Our overall objective is to develop and validate a smart technological tool to support healthy aging for frail older individuals. Indeed, a connected object would complement classic follow up by:

- continuous monitoring over the medium and long term;
- involving the patient;
- displaying data to the physician for more dynamic monitoring.

The tool we propose is a connected insole. There are several reasons for this choice:

- an insole could be worn without disturbing the person;
- several studies show that inertial sensors worn on the feet allow accurate measurement of walking speed (Mariani et al., 2010; Schepers, Asseldonk, Baten, & Veltink, 2010; Tien, Glaser, Bajcsy, Goodin, & Aminoff, 2010);
- walking could be exploited to charge the smart insole with a piezoelectric generator (Roundy & Wright, 2004; Glynn-Jones, Tudor, Beeby, & White, 2004; Meninger, Mur-Miranda, Amirtharajah, Chandrakasan, & Lang, 2001);
- pressure sensors under feet plants could be used to monitor weight changes automatically (Fried and al. criterion).

Some previous papers related to this work have been published by the authors of this paper (Charlon & Bourenanne, 2013; Charlon, Campo, Brulin, & Piau, 2015; Campo, Charlon, & Brulin, 2015; Piau, Charlon, Campo, Vellas, & Nourhashemi, 2015). This one presents the latest enhancements of hardware and software, overall results and feed-back from researchers and users.

The paper is organized as follows: section 2 describes FOOT-TEST project features, section 3 focuses on the design of the first prototype of the smart insole, section 4 concerns the design of the second version of the insole including an energy harvesting system, section 5 deals with the first evaluation of the global system, and section 6 presents the conclusions and work in progress.

## **2. FOOT-TEST project features**

### **2.1. Medical specifications**

Typically, the gait speed of frail patients is measured at the hospital by a standard test conducted on four meters in a straight line. The smart insole must provide a daily indicator to the physician who can estimate changes in gait speed compared to that recorded with the standard test. In order to set up a daily monitoring, patients that will follow the clinical protocol will be invited to put the insoles in their usual pairs of shoes. This involves moving the smart insoles from one pair of shoes to another that could be considered as a weakness because we suppose that the person will not forget to move insoles. However, it is the same problem for all pedometers regardless of which part of the body wears it.

According to needs reported by the medical field, the insole should be able to measure, during three months of monitoring, according to time (day, week, and month):

- distance covered and the number of strides;
- periods of activity;
- average gait speed during activity periods.

In order to ensure that the gait speed measurement is relevant, accuracy must be greater than 95% during natural gait. To increase accuracy, we propose to set up a learning phase to calibrate the smart insole to the real gait of each individual.

We also plan to measure a second Fried criterion, weight change, with a pressure sensor integrated into the thickness of the insole. This optional measure aims to complete the absolute weight measurement performed with a connected weighing scale. In order for this measurement to be relevant, the system must be able to measure a variation of 1 kg in a patient's weight, to detect significant variations (several kilograms), and to warn the physician automatically. The FOOT-TEST system must inform:

- the subject of his/her activity to motivate him/her to walk;
- the physician who sets the objectives for this patient and follows his/her evolution.

The main constraints related to use of the tool use are:

- the device should be unobtrusive and need no maintenance;
- the system must be autonomous concerning measurements, communication and energy.

The time of use of the tool must be three months (usual interval between two medical consultations).

## 2.2. Technological barriers

The technological barriers concern:

- integration of electronics in the thickness of an insole;
- accuracy of the measurements in ambulatory;
- energy autonomy of the system over the three months of follow-up.

Two prototypes were produced:

- a first version of smart insole supplied by a lithium battery;
- a second version of smart insole supplied by a hybrid system composed of a battery and an energy harvesting system.

## 2.3. General architecture of the FOOT-TEST system

The general architecture of the system consists of (Figure 1):

- a computer and a radio beacon to collect the data from the insole;
- a secure remote database;
- a web application accessible by the patient and the physician.

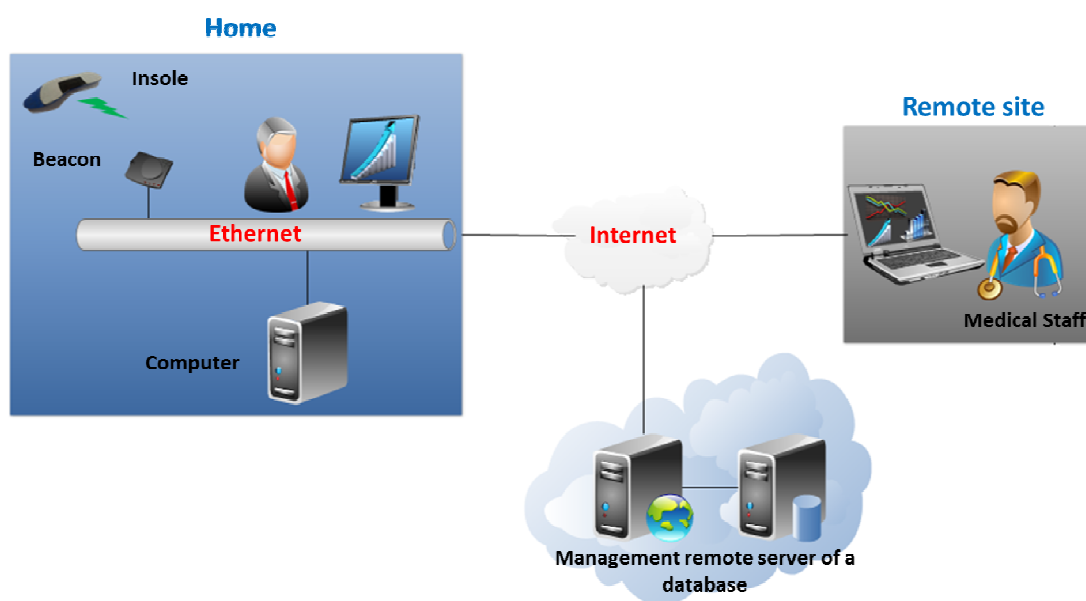

Figure 1. General architecture

### 3. Design of the first prototype of a smart insole

#### 3.1. State of the art and technological choice for gait monitoring

The main objective is to provide activity data to the physician and patient (distance and number of steps) and a reliable speed indicator to the physician (accuracy better than 95%). In literature, gait speed calculation is based on stride length measurement (Mariani et al., 2010; Schepers et al., 2010; Tien et al., 2010; Ladetto, 2000; Shin, Park, Kim, Hong, & Lee, 2007). Two methods are mainly used to calculate stride length with inertial sensors placed on shoes:

- mathematical integration of inertial signals (Mariani et al., 2010; Schepers et al., 2010; Tien et al., 2010);
- analytical method (Ladetto, 2000; Shin et al., 2007).

The mathematical integration method suffers from two major errors (Abbott & Powell, 1999; White, Bernstein, & Kornhauser, 2000):

- inclination of the foot causes a shift in the acceleration measured;
- signals integration causes drifts.

To correct the inclination error, it is necessary to use a gyrometer to know the foot's orientation (Schepers et al., 2010; Sabatini, Martelloni, Scapellato, & Cavallo, 2005). To correct the integration error, the Zero UPdate velociTY (ZUPT) method uses null velocity when the foot is on the ground (Nilsson, Skog, & Handel, 2010; Sagawa, Inooka, & Satoh, 2000). Several published results show that the distance obtained with this technique is accurate (between 1% and 7%) (Mariani et al., 2010; Schepers et al., 2010; Tien et al., 2010). Thus, to obtain a good accuracy it is necessary to use a 6D central mounted on footwear and to correct errors with ZUPT method.

To measure the stride length by the analytical method, several algorithms have been developed to determine the stride length by linear combination of different parameters: stride length, cadence, or the acceleration variance. Some research projects use this method with an accelerometer placed on the foot (Ladetto, 2000; Shin et al., 2007). In (Shin et al., 2007), the algorithm estimates the gait speed with a threshold on the vertical acceleration in order to adapt the calculation of the stride length. The error on the distance measurement is less than 5% in the worst case (slow gait). Table 1 presents the pros and cons of the methods used to compute gait speed.

**Table 1.** Comparison of the main methods used to compute gait speed

Method	Method Complexity	Sensors required	Minimum error rate	System energy consumption	References
Mathematical integration	Complex	Accelerometer and Gyrometer	1 %	High	Mariani et al., 2010; Schepers et al., 2010; Tien et al., 2010
Analytical	Simple	Accelerometer	4 %	Low	Ladetto, 2000; Shin et al., 2007

Finally, the mathematical integration method is attractive in terms of measurement accuracy with an error rate that may be close to 1%. However, that method requires the combination of an accelerometer and a gyrometer, which produced an increase in the energy consumption of the two devices. The analytical method is less accurate with an error rate of about 5%. This method's major drawback lies in the need to calibrate the system on the gait of the user. However, this method seems to be an interesting alternative in order to reduce the system's energy consumption because it only requires the use of a three - axis accelerometer. Thus, the development of an analytical method is more appropriate to the features of our project, in order to reduce energy consumption while offering accuracy of around 95%.

#### 3.2. Method and technological choice for monitoring weight change

##### 3.2.1. State of the art and technological choice

The objective is to alert the physician in case of significant weight loss (5 to 10% of patient's weight). The threshold will be determined by the attending physician. The system must be capable of detecting a change of 1 kg. Generally, distributed pressure sensors are used to analyze balance (Shu

et al., 2010; Abdul Razak, Zayegh, Begg, & Wahab, 2012). We therefore must adapt these sensors and methods to measure weight change.

While standing, resulting vertical forces under the surface of both feet correspond to the individual's weight. Figure 2 shows the main support zones of the foot, especially the heel which supports the majority of body weight (Abdul Razak et al., 2012; Racic, Pavic, & Brownjohn, 2009). Thus, we have chosen to observe pressure variations in the heel to estimate weight change.

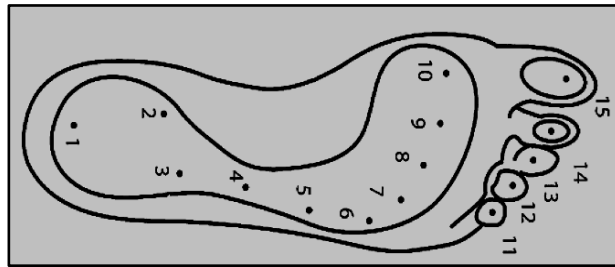

**Figure 2.** Support areas under the foot surface (Abdul Razak et al., 2012)

The resultant of vertical forces under the foot surface varies during the gait (Racic et al., 2009). The amplitude of these forces is correlated with the gait speed and the stride length (Racic et al., 2009). Thus, the individual's weight is multiplied by a coefficient of between 0 and 1.25 at a normal gait (1.5 m/s) (Racic et al., 2009). Walking speed and stride length must be known to produce a realistic weight dynamic measurement. A state-of-the-art of pressure sensors is presented in (Campo et al., 2015). This literature research led us to test and to compare two pressure sensors that we have positioned under the heel:

- 1) **A401 System:** A401 sensor (Tekscan) associated with its electronic conditioning (Campo et al., 2015).

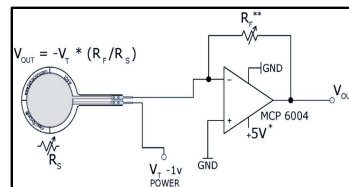

**Figure 3.** A401 sensor and its electronic conditioning

- 2) **MS4525-1PSI system:** MS4525-1PSI sensor associated with a winding silicone tube (thickness: 2 mm, surface: 3.5 cm<sup>2</sup>), solution adapted from (Kong & Tomizuka, 2009) and detailed in (Campo et al., 2015).

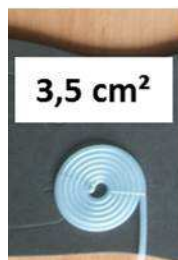

**MS4525 1PSI**



**Figure 4.** Winding of silicone tube and MS4525-1PSI sensor

A test bench was used to compare the two solutions.

### 3.2.2. Comparison of the two solutions

We have developed a test bench (Figure 5) composed of four parts:

- a test column ES20 (MARK-10 ES10/ES20 Manual, 2017) that makes it possible to apply a force on the sensor
- a standard force-sensor calibrated through a conditioner (Phidgets Inc. - 3138\_0 - S Type Load Cell, 2017);
- a USB-6008 data acquisition card (NI USB-6008 OEM - National Instruments, 2017);
- a computer with an acquisition application developed in Labview.

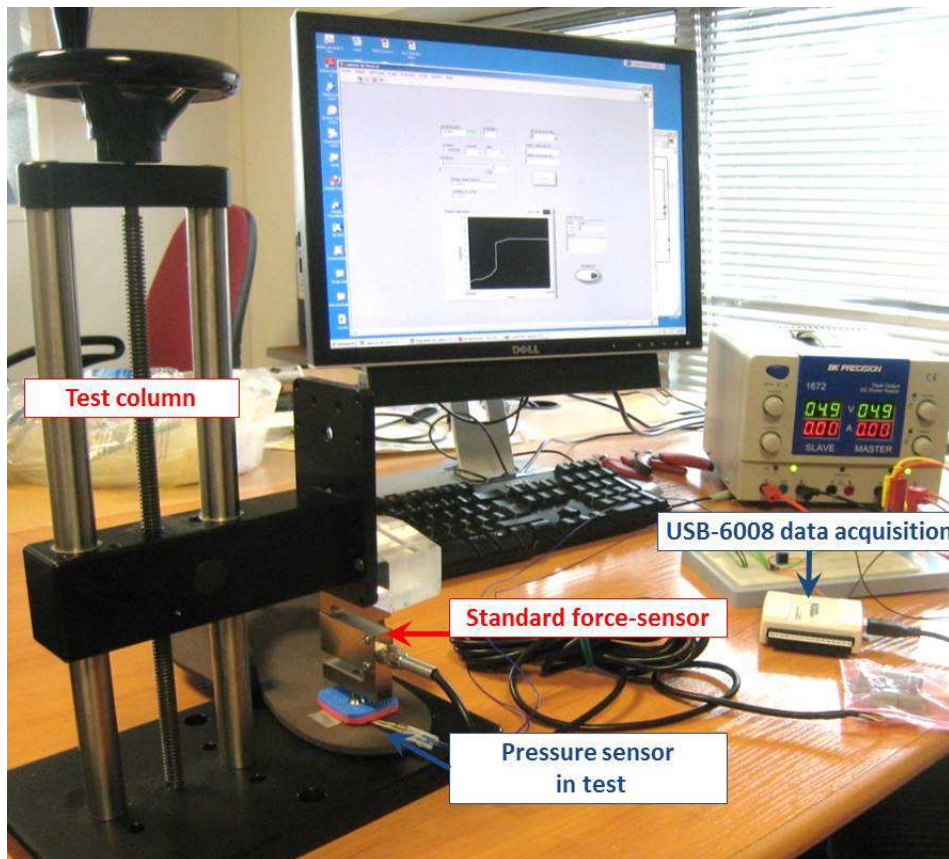

**Figure 5.** Overview of the test bench produced

Force is applied uniformly over the sensors to achieve a measure of reliable strength in a static state. Tests are performed with the test column; sampling frequency of the data acquisition card is set at 100 Hz. Three tests were performed for each solution:

- **Non-linearity tests** (Figure 6): loading of 50 KgF in 10 sec and then measuring the maximum relative deviation (%) with respect to a linear response;
- **Hysteresis tests** (Figure 7): setting load of 50 KgF in 1 sec and removing the charge in 1 s, then measuring the maximum relative deviation (%) to a linear response;
- **Repeatability test** (Figure 8): loading of 40 KgF for 10 sec 20 times, then calculating the average of each maximum (10 sec) and the maximum relative variation between the average maximum (%).



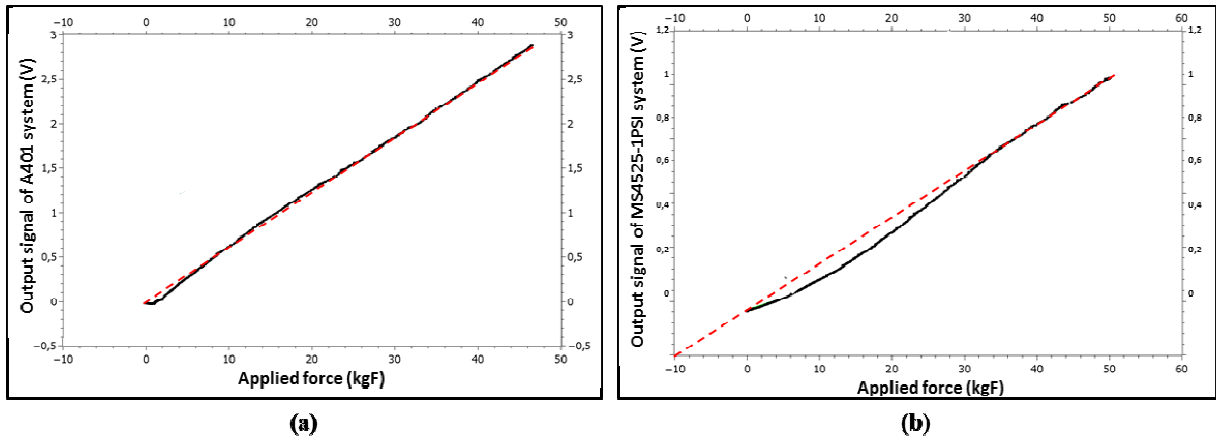

Figure 6. Nonlinearity tests: A401 FSR system (a); MS4525-1PSI system (b).

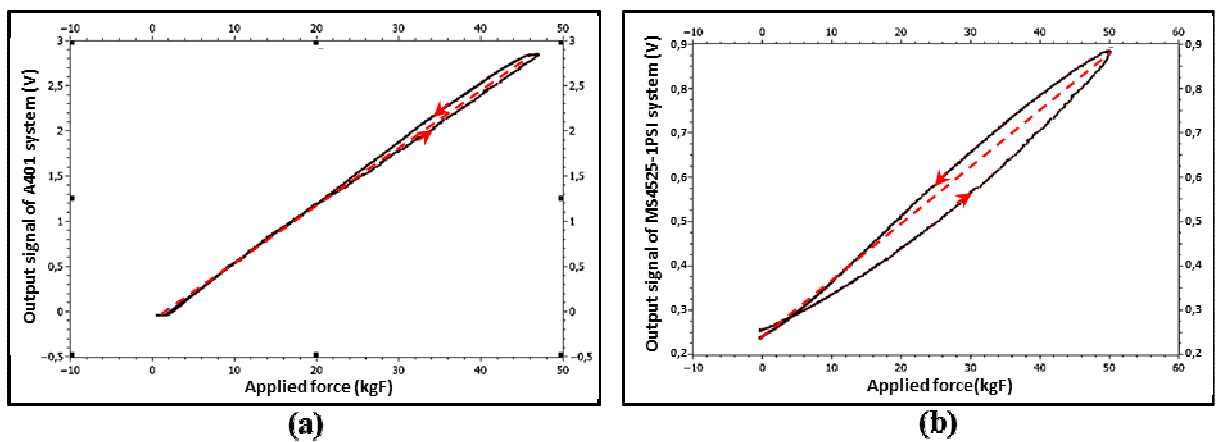

Figure 7. Hysteresis tests: A401 FSR system (a); MS4525-1PSI system (b).

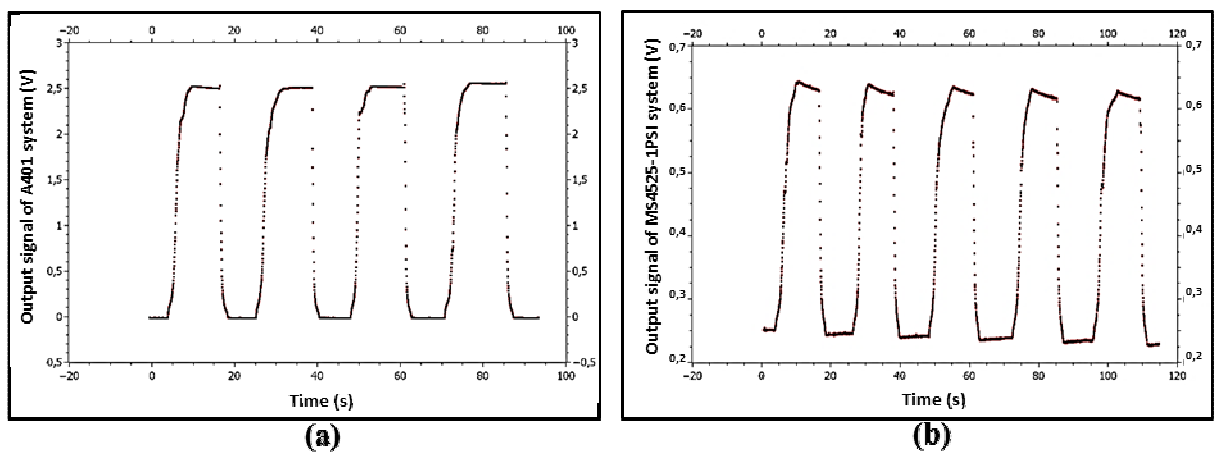

Figure 8. Repeatability tests: A401 FSR system (a); MS4525-1PSI system (b).

Results obtained are:

- **Non-linearity:** 1.5% for the A401 FSR system and 4% for the system MS4525-1PSI;
- **Hysteresis:** 3% for the A401 FSR system and 10% for the MS4525-1PSI system;
- **Repeatability:** 97% for the A401 FSR system and 95% for the MS4525-1PSI system.

Overall, we observed that the two solutions work well with an advantage for the A401 FSR solution, especially for hysteresis response. Following these tests, the A401 FSR system seems to be more efficient. Moreover, the conditioning electronic is more easily integrated into the thickness of an insole.



### 3.3. Insole prototype V1

Several discussions with professionals in podiatry led us to apply the following constraints: the system should be placed under the arch of the foot to maintain the comfort of the insole; maximum dimensions of the module must be 50\*30\*2 mm.

The first version of the device integrated in an insole is composed of: a MC13213 System in package (802.15.4 radio communication protocol), an ADXL345 accelerometer (low power), and the A401 system. Power is supplied by a CR2320 lithium battery (135 mAh). This device communicates with a radio beacon designed for our application and connected to the collecting computer (Figure 21).

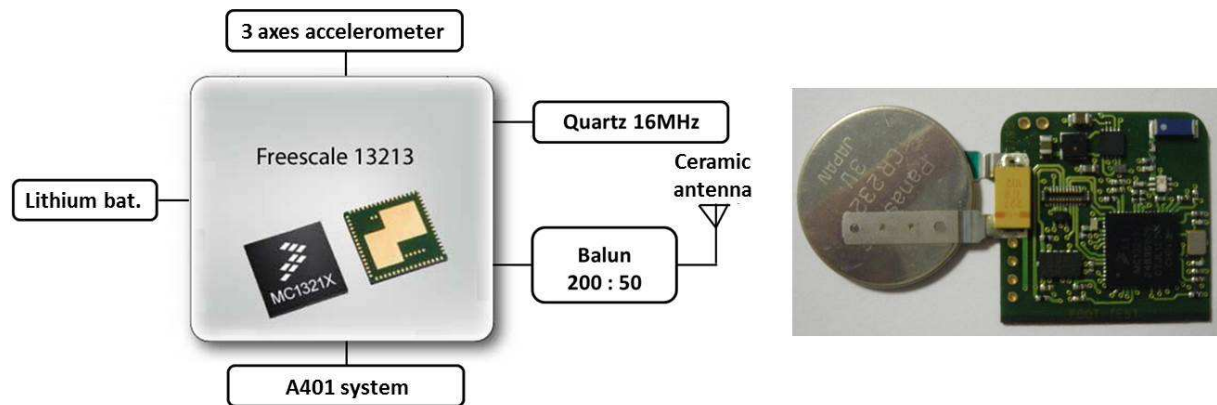

Figure 9. Block diagram of the device V1



Figure 10. Instrumented insole

In the first instance, the insole pair (right instrumented insole) was worn by a volunteer during one month, continuously, without discomfort noted by the volunteer and without damage to the module.

### 3.4. Measurement methods

#### 3.4.1. Characterization of the weighing system on a treadmill

The objective of this characterization step is to verify that the system is able to see a change in weight of 1 kg. Tests were performed several times by a young male participant on a treadmill at three walking speeds, with a loaded backpack weighing from 0 to 10 kg, using a calibrated weight of 1 kg. For these tests, the device delivers the output voltage of the weighing system to 100 Hz. A Matlab program was used to analyze the raw data. In established walking conditions, the variation in the voltage level between each stride can reach up to 7%. To limit the variations, the maximum has been averaged over 10 strides (variation of less than 1%).

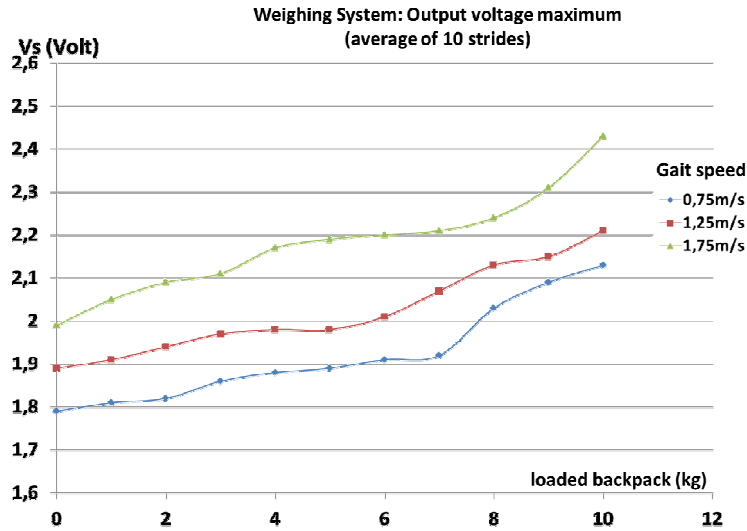

Figure 11. Characterization of the weighing system for different gait speeds

Figure 11 shows that the speed affects the pressures measured at the heel. For a gait speed set by the treadmill, a pressure increase is observed when the load in the backpack increases. It seems possible to observe variations on the order of 1 kg by placing the sensor in the heel under conditions set by averaging the maximum of 10 successive steps.

Work in progress focuses on detecting medium walking speed on flat surfaces. The objective is to collect several measurements per day under the same walking conditions to compute a daily average and observe the evolution over three months.

### 3.4.2. Detection of a medium gait speed on flat surfaces

The results presented in this section use a dataset obtained during a path carried out once by one volunteer. This path is shown in Figure 12.



Figure 12. Walking path

The smart insole was configured to capture sensors samples at 100 Hz (accelerometer and pressure sensor). Two parameters were monitored:

- output voltage  $V_0$  (V) of the A401 sensor electronic conditioner;
- calculation of the acceleration magnitude  $a_i(g)$ , with  $a_{xi}$ ,  $a_{yi}$ ,  $a_{zi}$  the samples of the axis x, y, z:

$$a_i = \sqrt{a_{xi}^2 + a_{yi}^2 + a_{zi}^2} \quad (1)$$

Then we measured 3 characteristics during the walk:

- the duration of each stride;
- the maximum of pressure ( $V_0$ ) and acceleration ( $a_i$ ) of each stride;
- the area under the curve of pressure ( $V_0$ ) and accelerations ( $a_i$ ) during each stride.

These measures require few calculation resources and seem sufficient to distinguish the different activities. Indeed, we see that the distributions for each activity are not (or only slightly) confounded, as shown in Figure 13.

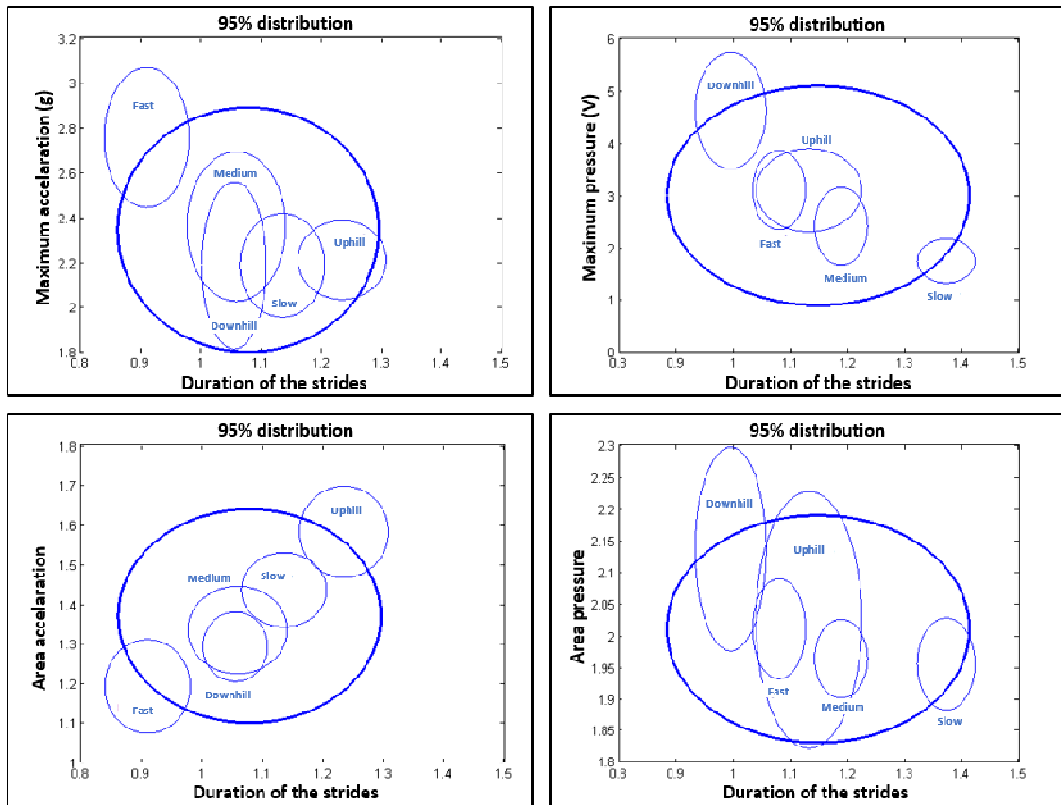

**Figure 13.** 95% distribution of the strides according to the measured characteristics

On Figure 13, the circles in bold represent the total distribution for each walking activity, while the thin circles represent the distribution for one case (slow walking, normal walking, etc.). We can see on the characteristic of the maximum pressure as a function of stride duration that the variance is more important for a walking on uphill or downhill rather than for a medium walking on a flat surface. Detection of medium walking on flat surfaces seems possible and should be able to measure the weight in the best conditions. This first result is encouraging, the tests continue with more volunteers. The addition of a second sensor to the front of the smart insole is also considered if we can't detect a weight variation of one kilogram with a single sensor.

### 3.4.3. Method for measuring average gait speed

The first version of our method was presented in (Charlon et al., 2015). Here we present the method details and the latest improvements. The method for measuring the average gait speed is composed of three steps:

- **step 1:** strides detection and measure of the average cadence;
- **step 2:** calibration using a system designed specifically;
- **step 3:** computation of the stride length, the distance covered, and the average gait speed for each gait period.

#### 1) Step 1: strides detection and measure of the average cadence

It is necessary to implement a robust stride detection method because the computing of other parameters is based on this first step. For stride detection, the most reliable algorithm found in literature is proposed by Jiménez et al. (Jimenez, Seco, Prieto, & Guevara, 2009). The error is 0.1% for a normal gait speed. Thus, we applied the algorithm proposed in this publication in order to verify these performances. We added a method to measure cadence. The accelerometer was configured to capture sensor samples at 100 Hz. The algorithm implemented for stride detection and cadence measurement consists of the following steps:

- Calculation of the acceleration magnitude  $a_i(g)$  (equation 1)
- Calculation of the mean acceleration  $\hat{a}_j(g)$  on an sliding window ( $w = 15 \text{ samples}$ ) with the acceleration magnitude  $a_q$ :

$$\hat{a}_j = \frac{1}{2w+1} \sum_{q=i-w}^{i+w} a_q \quad (2)$$

- Calculation of the variance acceleration  $\sigma_{ai}^2$  on an sliding window ( $w = 15 \text{ samples}$ ), to highlight the foot activity and to remove gravity:
- 

$$\sigma_{ai}^2 = \frac{1}{2w+1} \sum_{j=i-w}^{i+w} (a_j - \bar{a}_j)^2 \quad (3)$$

- Stride detection with two thresholds on the local acceleration variance:
  - The first threshold is fixed at 0.2 g in order to detect the rising edge;
  - The second threshold is fixed at 0.1 g in order to detect the falling edge.
- Use of two time limits between each stride to filter leg movements that are not strides:
  - The maximum waiting time between two strides is 3.5 s (slow gait);
  - The minimum waiting time between two strides is 0.4 s (fast gait).

Figure 14 illustrates the steps of the stride detection process.

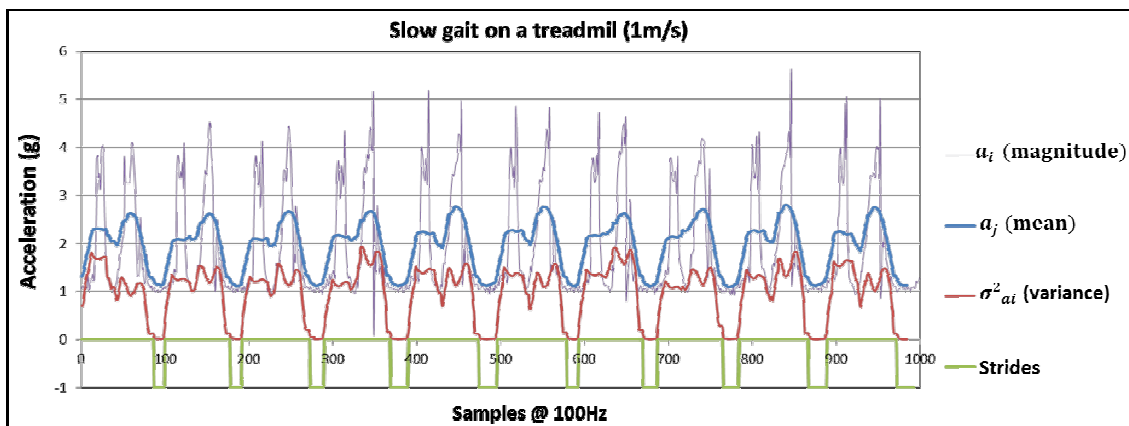

**Figure 14. Stride detection process**

Measurements performed by three volunteers on a treadmill (slow, normal and fast gait) confirm the robustness of this process. The error rate on the number of detected strides is less than 1% over the entire speed range studied and for each volunteer.

After strides detection, the  $C_n$  cadence expressed in steps per second (one stride is equivalent to two steps) can be computed with a sliding window on the last three strides (six steps):

$$C_n = \frac{6}{t_j - t_{j-3}} \quad (4)$$

Where  $C_n$  denotes cadence and the expression, " $t_j - t_{j-3}$ " denotes the elapsed time at which the last three strides are detected.

## 2) Step 2: calibration system of the smart insole

Three parameters are measured during the calibration step: average gait speed, average cadence and average stride length. These parameters are measured by asking the user to walk naturally at two different speeds (slow and medium) on 4 meters (medical procedure). The calibration system is composed of the following elements (Figure 15):

- an instrumented insole that measures the average cadence;
- two optical barriers that measure the average speed over 4 meters;
- a Kinect camera that measures the average stride length on two strides;
- a computer that collects the data and computes the calibration coefficients (equations 5, 6 and 7).

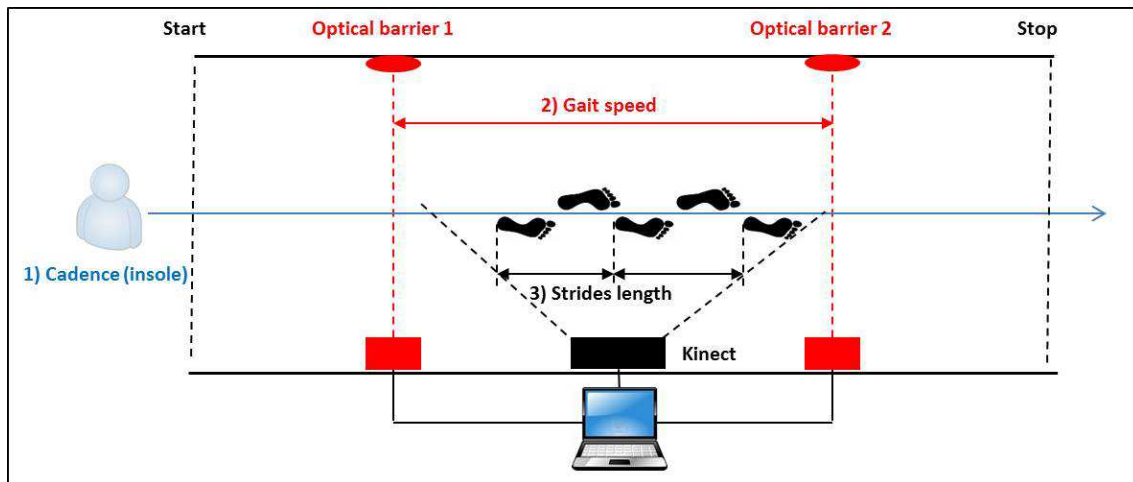

**Figure 15. Calibration system of the smart insole**

The measures must be performed during a stabilized walk. Thus, the user starts one meter before the first optical barrier and stops one meter after the second optical barrier. This way, gait speed is constant between the two optical barriers. The smart insole measures the cadence after the second stride when the walk is stabilized. Finally, the Kinect camera's field of view is set between the two optical barriers in order to measure two lengths of successive strides. Calibration software collects the data at two gait speeds and determines the calibration coefficients of equations 5, 6 and 7.

## 3) Step 3: computation of stride length, distance covered, and average gait speed

Three analytical methods for measuring stride length were tested and compared (Fang et al, 2007; Kubrak, 2007). The calibration system is used to determine the coefficients of equations 5, 6 and 7.

Coefficients are computed by using a linear regression between the points obtained at slow and medium gait speed. The three methods tested are presented here:

**method 1** (Fang et al, 2007): The stride length  $step_n$  is computed with the acceleration magnitude  $a_i$  (equation 1), where  $N$  denotes the samples number of the stride  $n$  detected at the time  $k$ , and  $\alpha$  a coefficient determined by calibration:

$$step_n = \frac{\alpha}{N+1} \sqrt[3]{\sum_{i=k}^N |a_i|} \quad (5)$$

**method 2** (Kubrak, 2007): The stride length  $step_n$  is determined by the following equation:

$$step_n = \alpha C_n + \beta v_n + \gamma \quad (6)$$

where:

- $\alpha, \beta, \gamma$  are coefficients determined by calibration;
- $C_n$  is cadence determined by equation 4;
- $v_n = \sigma^2_{a_{k-N,k}}$  is acceleration variance computed by equation 3.

**method 3** (Kubrak, 2007): The stride length  $step_n$  is determined by the following equation:

$$step_n = \alpha C_n + \beta RMS_n + \gamma Mean_n \quad (7)$$

where:

- $\alpha, \beta, \gamma$  are coefficients determined by calibration;
- $C_n$  is cadence determined by equation 4;
- $RMS_n = \sqrt{v_n}$  is the square root of acceleration variance computed by equation 3;
- $Mean_n$  is the mean acceleration computed by equation 2.

### 3.4.4. Comparison of methods

Three volunteers conducted tests during three step instructions (slow, medium and fast speed). The smart insole was calibrated for each volunteer to fit stride gait speed. Distance covered is computed by adding successive stride lengths. The mean error obtained over a distance of 400 meters (athletics stadium) for our three volunteers is shown in Table 2.

**Table 2.** Averaged distance error of the 3 volunteers

	Mean distance error (method 1)	Mean distance error (method 2)	Mean distance error (method 3)
Slow speed	9.6 %	4.9 %	3.9 %
Medium speed	9 %	3.4 %	2.5 %
Fast speed	9.1 %	12.8 %	3.2 %

The most accurate method is method 3. The mean average computed with the results of the three volunteers is 3.4%. An accuracy of 96.6% on average distance meets project specifications (greater than 95% accuracy). Gait speed is computed by dividing the distance covered by the time. After these tests, method 3 was used.

### 3.5. Energy consumption of the device

In order to reduce consumption while maintaining the accuracy of the method used to compute gait speed, the following parameters were selected:

- sampling frequency of the accelerometer is set to 25 Hz;

- the microcontroller awakens using a pressure threshold (passive sensor);
- limitation of the number of radio transmissions: the smart insole sends one synchronization request per minute to the beacon.

Use of the A401 system instead of the accelerometer to awake the microcontroller reduces power consumption in the idle periods (measured to 10  $\mu\text{A}$  with the A401 system against 40  $\mu\text{A}$  with the accelerometer). In order to determine average consumption, we measured the current passing through a serial resistor at 3 V (battery voltage). For an activity period followed by transmission of one data frame, average consumption is 100  $\mu\text{A}$  (0.3 mW). For an inactive period, average consumption is 10  $\mu\text{A}$  (0.03 mW). Considering that the activity of a person may vary between one and five hours by a day, autonomy should be between 200 and 400 days with a battery of 135 mAh.

Thus, this first prototype validates a technical feasibility step that meets the technical specifications of the smart insole. Indeed, the device can measure gait parameters with energetic autonomy of more than three months. A second version of the smart insole was designed in order to explore the possibility of equipping the system with an energy harvesting set up.

#### 4. Design of the smart insole version 2 with harvesting system

##### 4.1. Technological choice

Previous studies have shown that, for a 68-kg person walking with a speed of two steps/s and a heel movement of 5 cm, the maximum power that can be generated is 67W (Starner, 1996). However, if the interference with the gait brought by the energy harvesting devices is taken into consideration, the energy extracted from walking obviously will decrease. Three types of electromechanical conversions were used in shoes or insoles: piezoelectric, (Roundy & Wright, 2004), electromagnetic (Glynne-Jones et al., 2004), and electrostatic (Meninger et al., 2001). However, only the piezoelectric generators can be integrated in the insole thickness, the electromagnetic and electrostatic generators are too thick and heavy (Glynne-Jones et al., 2004; Meninger et al., 2001).

Macro Fiber Composite (MFC) is a planar piezoelectric device consisting of rectangular cross-section PZT fibers embedded in an epoxy matrix. Due to properties like flexibility, very small thickness and long term stability (Yang, Tang, & Li, 2009), the MFC generator can be embedded easily in the thickness of an insole. Indeed, we have tested the complete solution proposed by Smart Material Corporation® (Smart Material Corp, 2017). This solution, presented in Figure 16, is an energy harvesting system composed of an MFC piezoelectric generator (MFC M8528P2) and an AC/DC converter.

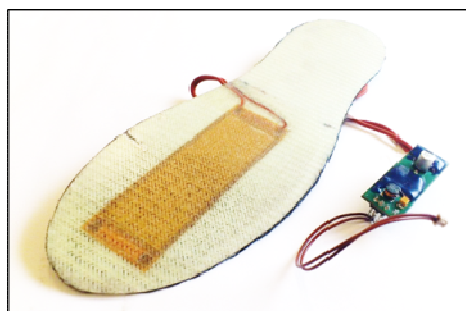

**Figure 16.** *Smart Material Corporation solution*

The tests we made of this system were presented in (Charlon & Bourenanne, 2013) and showed the feasibility of an autonomous energy-saving instrumented insole. After these first tests, we decided to design a miniaturized version of the AC/DC converter in order to integrate it in the thickness of an insole.

##### 4.2. Insole prototyping V2

To design a harvesting system that produces maximum energy, we used a MFC generator with a large active surface (M8557P2, Figure 17).





**Figure 17.** Integration of the MFC-M8557P2 generator

The second issue that we addressed is the need to reduce the size of the AC/DC converter in working at lower voltages. To resolve this issue, we used a voltage step-down circuit, the LTC3588-1 from Linear Technology Circuit (LTC3588-1, 2017). The typical application is presented in Figure 18. In this configuration, this circuit can produce a 3.3V output direct voltage ( $V_{OUT}$ ) when the input capacitor  $C_{STORAGE}$  is sufficiently charged by the piezoelectric generator ( $PGOOD = 1$ ).

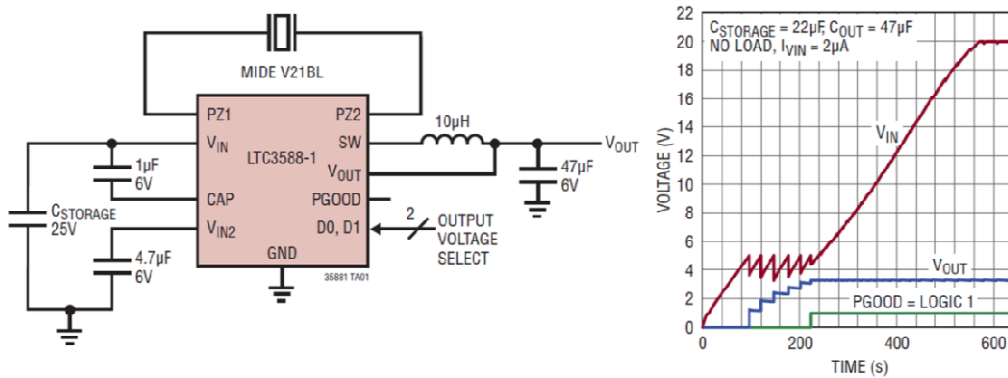

**Figure 18.** Typical application of the LTC3588-1 circuit (LTC3588-1, 2017)

This configuration was used to characterize, during walking, the energy production of our harvesting system composed of a MFC-M8557P2 generator and a LTC3588-1 circuit. To calculate the average power generated, we used two large capacity capacitors (30 mJ). Knowing that the capacity of the two capacitors is 30 mJ, we measured the capacitor charge time during the walking period in order to calculate the mean power produced. Mean power is calculated by dividing 30 mJ by the charge time of the capacitor. We used a data logger system to measure the capacitor voltage. In order to minimize the voltage cutoff of this system, the sampling rate is configured to low frequency (5Hz). Figure 19 shows the results of average energy production as a function of the gait speed fixed by a treadmill.

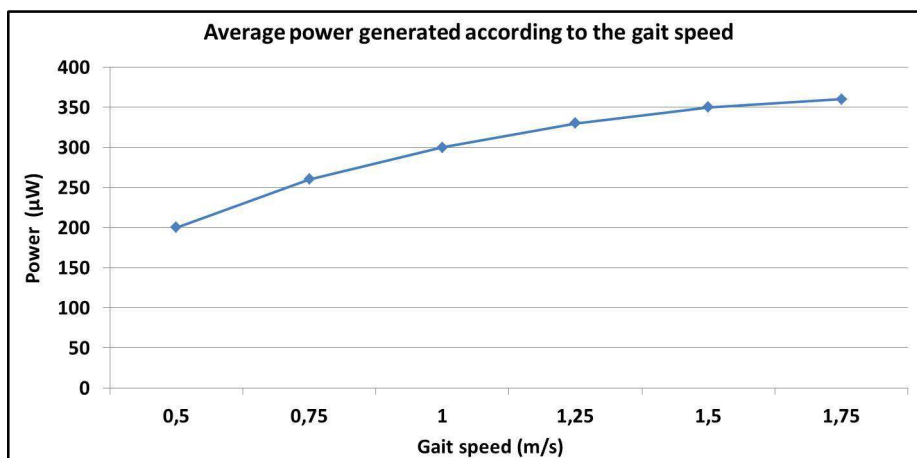

**Figure 19.** Average power generated according to gait speed

Beyond 1 m/s, average power produced is greater than the 0.3 mW necessary to supply the smart insole during activity periods. However, according to the scenario of one hour of activity per day, it is necessary to produce approximately 1 mW ( $1h \cdot 0.3mW + 23h \cdot 0.03mW$ ). In the case of a frail elderly individual, walking at an average speed of 1 m/s during one hour per day ( $300\mu W$  generated), only 3/10 of the energy needs of the smart insole (1mW) are covered. Finally, a system for the management and storage of this energy should be designed, which causes further energy loss.

These results are encouraging, with the possibility of supplying the smart insole during activity periods when gait speed is 1 m/s or greater. Thus, a hybrid supply system composed of a lithium battery and an energy harvesting system has been developed. The objective is to verify that it is possible to supply the system during an activity period.

In this configuration (Figure 20), the module is supplied either by the energy harvesting system when it produces enough energy or by the lithium battery. The surface of the new printed circuit board (PCB) is larger than before and semi-flexible in order to keep the smart insole comfortable. The V2 dimensions of the device are  $50 \cdot 28 \cdot 2$  mm.

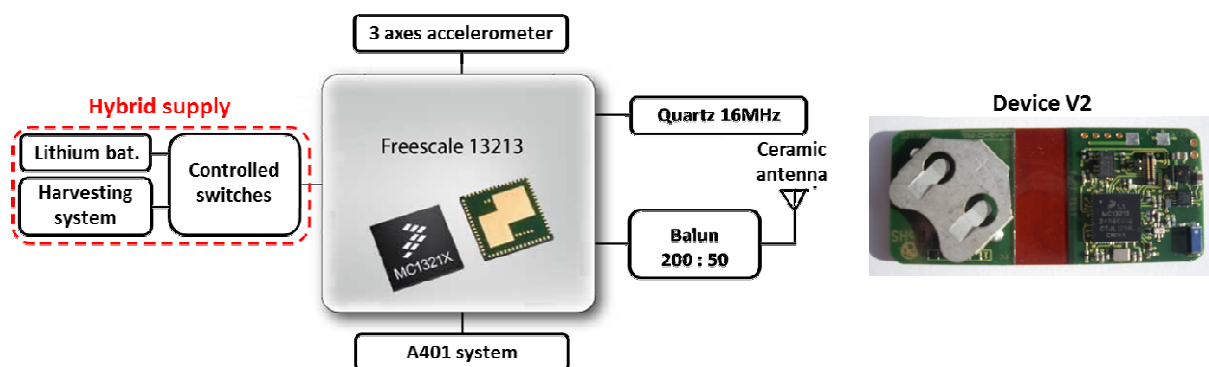

Figure 20. Block diagram of the V2 supply system



Figure 21. Smart insole V2

#### 4.3. Description of the smart insole V2 supply system

In order to characterize the energy harvesting system, we conducted tests on a treadmill configured at several speeds. We compared the distribution of supply time between the lithium battery and the harvesting system. Figure 22 shows the percentage of the supply time by the harvesting system (measured over one minute).

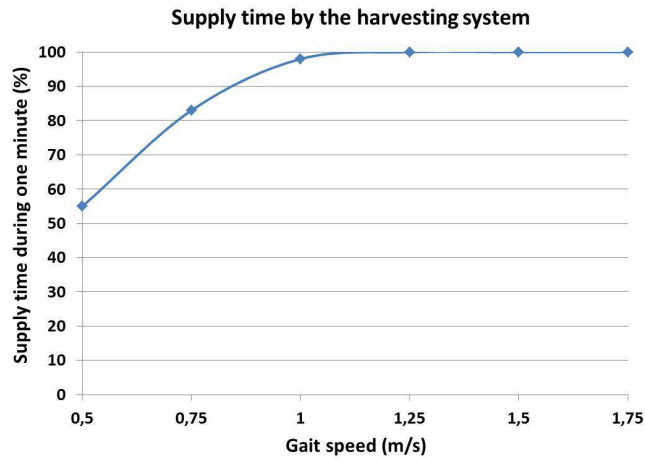

**Figure 22.** *Supply time by the harvesting system*

Between 0.5 m/s and 1 m/s, the supply time with this system is between 55 and 98%. Over 1 m/s the harvesting system can provide 100% of the power needs of the smart insole during activity periods. In the end this solution will not be used to manufacture the industrial version of the smart insole because the price of the MFC generator is high (> 100 euros). Other clinical and sports applications could be envisaged with this energy harvesting system. The solution finally chosen to perform the first-use evaluation in real conditions is the smart insole version 1.

## 5. First evaluation of the FOOT-TEST system

### 5.1. System architecture at home

The smart insole records data and transmits them wirelessly when the receiver is under the radio range.



**Figure 23.** *System architecture installed at home*

Smart insoles V1 (one insole instrumented) must replace the user's shoe insoles (Figure 24).



**Figure 24.** *Replacement of the user's shoe insoles*

The FOOT-TEST data collecting software has been developed in JAVA (Figure 25). Indicators used by physicians are gait parameters (cadence, number of steps, gait speed, distance covered) averaged by day, week, month and year.

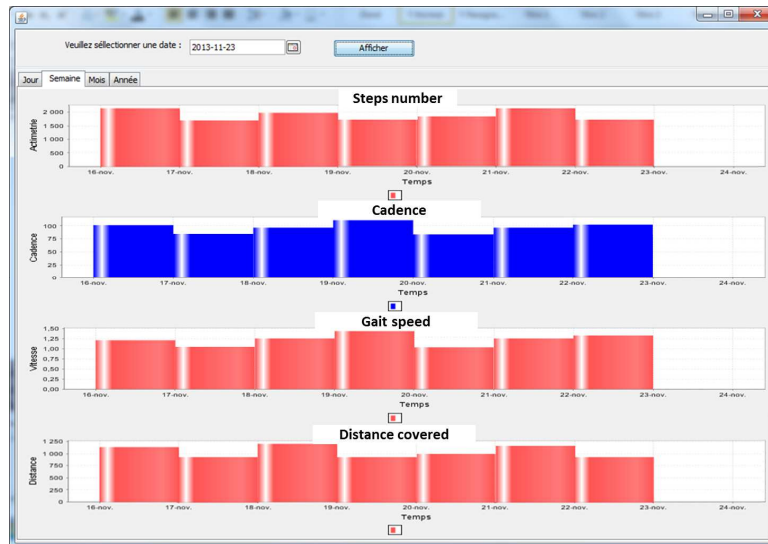

Figure 25. FOOT-TEST data collecting software

## 5.2. System evaluation

Several commercial connected pedometers were compared with our tool in terms of behaviour and performance. The evaluation was performed by five volunteers (two young men, a woman and two women aged over 65). All systems were worn together during one week. The connected components used are presented below:

- the FOOT-TEST system;
- a Withings Pulse belt clip (Withings Store, 2017);
- a Fitbit Zip belt clip (Fitbit® ZipTM, 2017);
- a Fitbit Flex wristband (Fitbit® FlexTM, 2017).

### Smart insole V1



### Withings clip



### Fitbit clip and wristband



Figure 26. Connected components used to carry out the FOOT-TEST evaluation

### 5.2.1. Performance evaluation

Each volunteer performed one lap of an athletics stadium (400 m) at normal gait speed. Table 3 shows the errors averaged on the number of steps and the distance covered.

Table 3. Performance comparison

	Wristband (Fitbit Flex)	Belt clip (Fitbit Zip)	Belt clip (Withings pulse)	Smart insole V1
Average error on number of steps	2,6%	1,2%	0,8%	0,6%
Average error on distance covered	11,7%	9,1%	8,3%	2,9%

The commercial connected pedometers are calibrated with the size and the weight of the individual. With these data, stride accuracy logically is low. To count of the number of steps, the method used by the smart insole is the most accurate (99.4%).

### 5.2.2. User feedback

The five volunteers adhered to the experiment during the evaluation. Several aspects were compared by collecting user feedback and are summarized below and in Table 4:

- **synchronization:** the advantage is given to systems that offer automatic synchronization;
- **autonomy:** the advantage is given to systems supplied by lithium battery because the autonomy is greater;
- **wear:** the advantage is given to the smart insole because, when placed in the shoe, it is completely transparent to the user;
- **interface:** Fitbit offers the most user-friendly and easy to use version. The FOOT-TEST interface must be improved.

**Table 4.** Opinions synthesis

	Synchronization	Autonomy	Wear	Interface
Smart insole V1	+	+	++	-
Withings clip	+	-	+	+
Fitbit clip	-	+	+	++
Fitbit wristband	+	+	--	++

### 5.3. Implementation of the gait speed indicator

The objective is to give a reliable indicator of gait speed to allow the physician to assess its evolution over the three months of follow-up. For this, several treatments have been applied to the data set of walking:

- calculation of daily average from all readings during the day;
- calculation of daily average from all readings beyond 25 steps;
- calculation of daily averages from the three longest walks of the day.

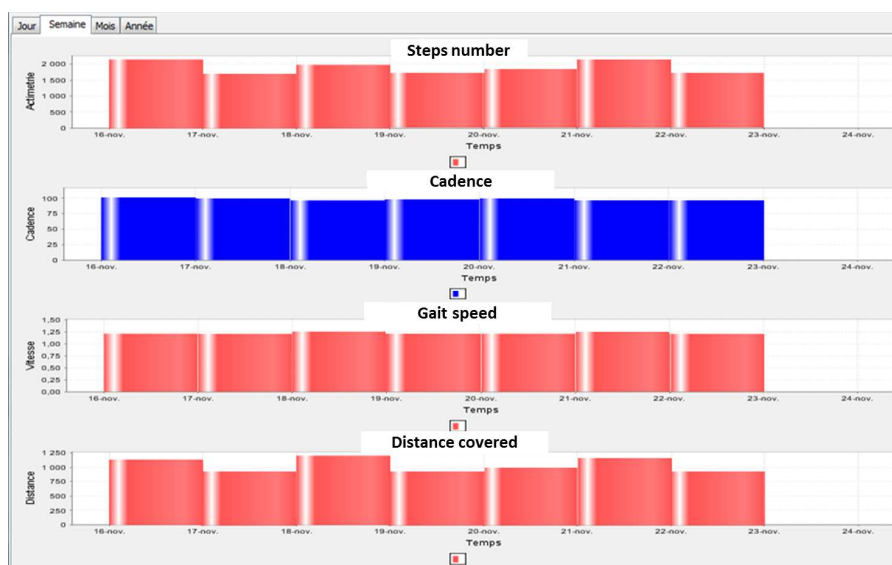

**Figure 27.** Follow-up of one user over a week with the daily cadence and gait speed indicators computed using the average from the three longest walks of the day

After these treatments, it appears that the use of the three longest gait periods during each day allows the obtention of reliable indicators. Indeed, in Figure 27, we observe that average daily speed

and cadence indicators are more stable than in Figure 25. The cadence and the gait speed obtained are close to the values recorded during calibration (difference of less than 5% for each volunteer). Raw data will be accessed by users and the physician. Daily indicators will be accessible only by the physician.

## 6. Conclusion

Our work is in the field of connected health. We have tried to answer a need for monitoring walking parameters representative of the physical activity of the person in his daily life.

A smart insole for daily monitoring of the way that frail people walk was proposed and accomplished. Several issues related to this work had to be addressed as:

1) Minituarization: by minimizing the size of the system so that it is worn in the thickness of a shoe, we propose a system that can be worn in a natural way by the user. We believe that the technological object must be associated with the existing domestic environment, even with the clothes or accessories usually worn by the person. This gives a positive and "natural" image to the technical object that will be more easily accepted.

2) Energy autonomy: the issue of energy autonomy was also addressed by the design of a system of energy recovery. This work shows that it is possible to design fully autonomous intelligent systems even if the problem of cost has to be solved. This is an important contribution in the field of connected health because we must ensure continuity of service.

3) Embedded data processing: we had to propose a method of calculating the walking speed based on the learning of the user's stride to obtain a high precision. This algorithm has been optimized from an energy point of view.

4) Medical Data Collection and Privacy: At this stage of the project we were able to recover data for storage on a secure server. The question of the management of these medical data is being studied in the following of the project. This will be a growing problem in the field of connected health.

Two prototypes were designed in order to work on the technological obstacles: electronics integration, accurate measurement of gait speed, measurement of weight change and energetic autonomy.

The first issue is integration of the electronics in the thickness of an insole. The proposed solution has been to place the electronics device under the foot arch by reducing the thickness to 2 mm. Subsequent to the design of two versions of the smart insoles no discomfort or damage was noticed.

The second issue concerns measurement of average gait speed with accuracy better than 95% while maintaining energetic autonomy for three months. To resolve this issue, an analytical method has been developed to measure stride length. Initial ambulatory tests show that accuracy is greater than 95% with an energetic autonomy of more than the expected three months.

The weight change measurement issue is not yet completely resolved. Indeed, the first tests show that the A401 system integrated in an insole is able to detect a weight increase of one kilogram in gait conditions fixed by a treadmill. On a flat surface the preliminary results show that the same detection could be possible. Thus, we recommend implementing a learning phase in order to recognize the right ambulatory walk conditions for weight measurement (walk on a flat surface at a normal gait speed).

Another technological barrier concerns the total energetic autonomy of the smart insole. Our solution was to design an energy harvesting system. A hybrid supply system composed of a lithium battery and a harvesting system was integrated into the insole thickness and showed that it could supply the smart insole V2 during activity periods. However, this system will not be used to manufacture the industrial version of the smart insole because the cost of the MFC piezoelectric generator is too high (>100 euros).

Both of the smart insole prototypes have made it possible to validate the technical feasibility of an ambulatory instrument capable of measuring gait parameters over three months.

A first evaluation of the smart insole in use conditions was performed. According to user feedback, it seems that the smart insole could be used more than commercial connected pedometers to monitor walking. Moreover, in terms of performance, the smart insole provides better results.

## 7. Work in progress

The step in progress consists of the technical and clinical validation of the smart insole to monitor frail people in their daily lives. Focus is on the definition of medical protocols and user interfaces. We plan to evaluate and improve our device in two steps:

The first clinical and technical feasibility trial will include 15 healthy old people to evaluate the acceptability and the technical performance of the first prototype. In this first clinical phase, we are planning to make technical improvements to the insole by adding an additional frailty parameter measurement: weight monitoring, and by developing a touchpad motivational coaching software through the Internet.

The final solution (shoe insole and coaching software) will be evaluated in a larger clinical comparative study to assess its acceptability during field tests in real-life conditions. This phase will include thirty frail individuals living at home. We believe that our solution has to be patient-centered. Nevertheless, the solution provides the physician with additional useful information (health status and adherence to recommendations) without interfering with the organization of health care. We can enumerate some perspectives related to this work and give some recommendations on several levels:

- **Design of the smart insole:** improvements are to be expected, mainly to miniaturize and increase the energetic autonomy. Recent advances in MEMS sensors and SoC or SiP chips already allow us to reduce the size and consumption of our system (under development). In addition, progress in energy harvesting will continue, enabling systems that are completely transparent and autonomous to be integrated into clothing. These technological advances make it possible to envisage a precise and continuous ambulatory remote follow-up.
- **New measurements:** other parameters with the currently version of the smart insole could be added like jogging monitoring or fall detection. Plantar pressure measurements using distributed pressure sensors are envisaged. This opens the way for further analysis of the walking and its characteristics. Many clinical and sports applications are possible: walking biomechanical study, rehabilitation, follow-up of diabetic patients, etc.
- **Data analysis:** we are currently working on the development of a general platform that uses all data pushed by different connected devices like the insole to allow for a two-step decision-making process (detection and intervention) based on expert rules. This platform will not be only dedicated to walking and weighting monitoring but all works started the last 5 years will contribute to design the software architecture of the platform.
- **Global issue:** this project also addresses global issues relating to our centralized health system. There is a potential benefit for the frail older persons in adopting this kind of connected solution, because of their active involvement in a healthy lifestyle project.

In our research works, we try to propose new connected solutions in the health field. Current efforts to integrate new functions, particularly with physiological characteristics, should allow us to propose the design of a more complex embedded architecture (BODYLAN) and the definition of new distributed sensors.

## 8. Acknowledgments

The authors thank the French regional DIRECCTE agency for financial support of the Foot-Test project and the Hospital of Toulouse Purpan for help and advice on definition of the concept of frailty and on user needs.



## 9. References

- Abbott, H. & Powell, D. (1999). Land-vehicle navigation using GPS. *Proc. IEEE*, 87(1), 145-162. doi: 10.1109/5.736347
- Abdul Razak, A. H., Zayegh, A., Begg, R. K., & Wahab, Y. (2012). Foot Plantar Pressure Measurement System: A Review. *Sensors*, 12(12), 9884-9912. doi:10.3390/s120709884
- Abellan van Kan, G., Rolland, Y., Andrieu, S., Bauer, J., Beauchet, O., Bonnefoy, M. (2009). Gait speed at usual pace as a predictor of adverse outcomes in community-dwelling older people an International Academy on Nutrition and Aging (IANA) Task Force, *J. Nutr. Health Aging*, 13(10), 881-889.
- Campo, E., Charlon, Y., & Brulin, D. (2015). Instrumented insole for weight measurement of frail people. *PETRA '15 Proceedings of the 8th ACM International Conference on Pervasive Technologies Related to Assistive Environments*, ACM, New York, NY, USA, Article No. 60. doi: 10.1145/2769493.2769525
- Cesari, M., Kritchevsky, S. B., Penninx, B. W. H. J., Nicklas, B. J., Simonsick, E. M., Newman, A. B., ... Pahor, M. (2005). Prognostic value of usual gait speed in well-functioning older people--results from the Health, Aging and Body Composition Study. *J. Am. Geriatr. Soc.*, 53(10), 1675-1680. doi: 10.1111/j.1532-5415.2005.53501.x
- Charlon, Y., & Bourenanne, I. (2013). Feasibility test of a smart shoe insole self powered. *Journées Nationales sur la Récupération et le Stockage d'Energie (JNRSE)*, 1-2. Retrieved from <http://www.captronic.fr/Journees-Nationales-sur-la,859.html>
- Charlon, Y., Campo, E., Drulin, D., & Piau, A. (2015). Smart insole for measuring actimetry of frail people. *Med-e-Tel 2015*. Retrieved from [https://www.medetel.eu/download/2015/parallel\\_sessions/presentation/day1/Smart\\_insole.pdf](https://www.medetel.eu/download/2015/parallel_sessions/presentation/day1/Smart_insole.pdf)
- Daniels, R., Rossum, E., Witte, L., Kempen, G. I., & Heuvel, W. (2008). Interventions to prevent disability in frail community-dwelling elderly: a systematic review. *BMC Health Serv. Res.*, 8(1) 278. doi:10.1186/1472-6963-8-278
- Fang, L., Antsaklis, P. J., Montestruque, L., McMickell, M. B., Lemmon, M., Sun, Y., ... & Xie, X. (2005). Design of a wireless assisted pedestrian dead reckoning system - the NavMote experience. *IEEE Trans. Instrum. Meas.*, 54 (6), 2342-2358. doi: 10.1109/TIM.2005.858557
- Fitbit® FlexTM Retrieved February 2, 2017, from <http://www.fitbit.com/fr/flex>
- Fitbit® ZipTM Retrieved February 2, 2017, from <http://www.fitbit.com/fr/zip>
- Fontecha, J., Hervás, R., Bravo, J., Navarro, F.J. (2013). A mobile and ubiquitous approach for supporting frailty assessment in elderly people. *J. Med.* 15(9), 197. doi: 10.2196/jmir.2529
- Fried, L. P., Ferrucci, L., Darer, J., Williamson, J. D., & Anderson, G. (2004). Untangling the concepts of disability, frailty, and comorbidity: implications for improved targeting and care. *J. Gerontol. A. Biol. Sci. Med. Sci.*, 59(3), 255-263. Retrieved from <https://doi.org/10.1093/gerona/59.3.M255>
- Glynn-Jones, P., Tudor, M. J., Beeby, S. P., & White, N. M. (2004). An electromagnetic, vibration-powered generator for intelligent sensor systems. *Sens. Actuators Phys.*, 110(1-3), 344-349. doi: 10.1016/j.sna.2003.09.045
- Jimenez, A., Seco, F., Prieto, C., & Guevara, J. (2009). A comparison of Pedestrian Dead-Reckoning algorithms using a low-cost MEMS IMU. In *IEEE International Symposium on Intelligent Signal Processing (WISP 2009)*, 37-42. doi: 10.1109/WISP.2009.5286542
- Kong, K. & Tomizuka, M. (2009). A Gait Monitoring System Based on Air Pressure Sensors Embedded in a Shoe. *IEEEASME Trans. Mechatron.*, 14(3), 358-370. doi: 10.1109/TMECH.2008.2008803
- Kubrak, D. (2007). Hybridisation of a GPS Receiver with Low-Cost Sensors for Personal Positioning in Urban Environment (Doctoral dissertation). Retrieved from <https://pastel.archives-ouvertes.fr/pastel-00002803>
- Ladetto, Q. (2000). On foot navigation: continuous step calibration using both complementary recursive prediction and adaptive Kalman filtering. In *13th International Technical Meeting of the Satellite Division of The Institute of Navigation (ION GPS 2000)*, 1735-1740. Retrieved from <http://citeseerx.ist.psu.edu/viewdoc/citations?doi=10.1.1.454.6853>
- LTC3588-1 - Nanopower Energy Harvesting Power Supply - Linear Technology Retrieved February 2, 2017, from <http://www.linear.com/product/LTC3588-1>
- Makai, P., Perry, M., Robben, S.H., Schers, H.J., Heinen, M.M., Olde Rikkert, M.G. (2014). Evaluation of an eHealth intervention in chronic care for frail older people: Why adherence is the first target. *J. Med.* doi: 10.2196/jmir.3057
- Mariani, B., Hoskovec, C., Rochat, S., Büla, C., Penders, J., & Aminian, K. (2010). 3D gait assessment in young and elderly subjects using foot-worn inertial sensors. *J. Biomech.*, 43(15), 2999-3006. doi: 10.1016/j.jbiomech.2010.07.003
- MARK-10 ES10/ES20 Manual Tensile/Compression Force Measurement Test Stands Retrieved February 2, 2017, from <http://www.mark-10.com/instruments/stands/es10.html>

- Martin Schepers, H., Asseldonk, E. H. F., Baten, C. T. M., & Veltink, P. H. (2010). Ambulatory estimation of foot placement during walking using inertial sensors. *J. Biomech.*, 43(16), 3138-3143. doi: 10.1016/j.jbiomech.2010.07.039
- Meninger, S., Mur-Miranda, J. O., Amirtharajah, R., Chandrakasan, A., & Lang, J. H. (2001). Vibration-to-electric energy conversion. *IEEE Trans. Very Large Scale Integr. VLSI Syst.*, 9(1), 64-76. doi: 10.1109/92.920820
- Montero-Odasso, M., Schapira, M., Soriano, E. R., Varela, M., Kaplan, R., Camera, L. A., & Mayorga, L. M. (2005). Gait velocity as a single predictor of adverse events in healthy seniors aged 75 years and older. *J. Gerontol. A. Biol. Sci. Med. Sci.*, 60(10), 1304-1309. doi: 10.1093/gerona/60.10.1304
- Nelson, M. E., Layne, J. E., Bernstein, M. J., Nuernberger, A., Castaneda, C., Kaliton, D., ... Fiatarone Singh, M. A. (2004). The effects of multidimensional home-based exercise on functional performance in elderly people. *J. Gerontol. A. Biol. Sci. Med. Sci.*, 59 (2), 154-160. Retrieved from <https://doi.org/10.1093/gerona/59.2.M154>
- NI USB-6008 OEM - National Instruments Retrieved February 2, 2017, from <http://sine.ni.com/nips/cds/view/p/lang/fr/nid/202751>
- Nilsson, J.O., Skog, I., & Handel, P. (2010). Performance characterisation of foot-mounted ZUPT-aided INSs and other related systems. In 2010 International Conference on Indoor Positioning and Indoor Navigation (IPIN), 1-7. doi: 10.1109/IPIN.2010.5646939
- Pahor, M., Blair, S. N., Espeland, M., Fielding, R., Gill, T. M., Guralnik, J. M., ... Studenski, S. (2006). Effects of a physical activity intervention on measures of physical performance: Results of the lifestyle interventions and independence for Elders Pilot (LIFE-P) study. *J. Gerontol. A. Biol. Sci. Med. Sci.*, 61 (11), 1157-1165. Retrieved from <https://www.ncbi.nlm.nih.gov/pubmed/17167156>
- Phidgets Inc. - 3138\_0 - S Type Load Cell (0-100kg) - CZL301C Retrieved February 2, 2017, from [http://www.phidgets.com/products.php?category=34&product\\_id=3138\\_0](http://www.phidgets.com/products.php?category=34&product_id=3138_0)
- Piau, A., Charlon, Y., Campo, E., Vellas, B., & Nourhashemi, F. (2015). A Smart Insole to Promote Healthy Aging for Frail Elderly Individuals: Specifications, Design, and Preliminary Results. *JMIR Rehabil Assist Technol*, 2(1), 1-5. doi: 10.2196/rehab.4084.
- Racic, V., Pavic, A. & Brownjohn, J. M. W. (2009). Experimental identification and analytical modelling of human walking forces: Literature review. *J. Sound Vib.*, 326(1-2), 1-49. doi: 10.1016/j.jsv.2009.04.020
- Roundy, S. & Wright, P. K. (2004). A piezoelectric vibration based generator for wireless electronics. *Smart Mater. Struct.*, 13(5), 1131. doi: 10.1088/0964-1726/13/5/018
- Sabatini, A. M., Martelloni, C. Scapellato, S., & Cavallo, F. (2005). Assessment of walking features from foot inertial sensing. *IEEE Trans. Biomed. Eng.*, 52 (3), 486-494. doi: 10.1109/TBME.2004.840727
- Sagawa, K., Inooka, H., & Satoh, Y. (2000). Non-restricted measurement of walking distance. In 2000 IEEE International Conference on Systems, Man, and Cybernetics, 3, 1847-1852. doi: 10.1109/ICSMC.2000.886378
- Shin, S. H., Park, C. G., Kim, J. W., Hong, H. S., & Lee, J. M. (2007). Adaptive Step Length Estimation Algorithm Using Low-Cost MEMS Inertial Sensors. In *IEEE Sensors Applications Symposium (SAS'07)* 1-5. doi: 10.1109/SAS.2007.374406
- Shu L., Hua T., Wang Y., Qiao Li, Q., Feng, D. D., & Tao, X. (2010). In-shoe plantar pressure measurement and analysis system based on fabric pressure sensing array. *IEEE Trans. Inf. Technol. Biomed. Publ. IEEE Eng. Med. Biol. Soc.*, 14(3), 767-775. doi: 10.1109/TITB.2009.2038904
- Smart Material Corp Retrieved February 2, 2017, from <http://www.smart-material.com/>
- Sparrow, D., Gottlieb, D.J., Demolles, D., Fielding, R.A. (2011). Increases in muscle strength and balance using a resistance training program administered via a telecommunications system in older adults. *J. Gerontol. A. Biol. Sci. Med. Sci.* , 66(11), 1251-1257. doi: 10.1093/gerona/66.11.1251
- Starter, T. (1996) Human-powered wearable computing. *IBM Syst. J.*, 35 (3.4), 618-629. doi: 10.1147/sj.353.0618
- Tien, I., Glaser, S. D., Bajcsy, R., Goodin, D. S., & Aminoff, M. J. (2010). Results of using a wireless inertial measuring system to quantify gait motions in control subjects. *IEEE Trans. Inf. Technol. Biomed. Publ. IEEE Eng. Med. Biol. Soc.*, 14(4), 904-915. doi: 10.1109/TITB.2009.2021650
- Van Het Reve, E., Silveira, P., Daniel, F., Casati, F., de Bruin, E.D. (2014). Tablet-based strength-balance training to motivate and improve adherence to exercise in independently living older people: Part 2 of a phase II preclinical exploratory trial. *J. Med.* 16(6), 159. doi: 10.2196/jmir.3055
- Van Kan, G. A., Rolland, Y., Bergman, H., Morley, J. E., Kritchevsky, S. B., & Vellas, B. (2008). The IANA Task Force on frailty assessment of older people in clinical practice. *J. Nutr. Health Aging*, 12 (1), 29-37. doi: 10.1007/BF02982161
- White, C. E., Bernstein, D., & Kornhauser, A. L. (2000). Some map matching algorithms for personal navigation assistants. *Transp. Res. Part C Emerg. Technol.*, 8(1-6), 91-108. doi: 10.1016/S0968-090X(00)00026-7
- Withings Store Retrieved February 2, 2017, from <http://www.withings.com/fr/withings-pulse.html>

- Yamada, M., Mori, S., Nishiguchi, S. (2012). Pedometer-based behavioral change program can improve dependency in sedentary older adults: A randomized controlled trial. *J. Frailty Aging*, 1,39-44. doi: 10.14283/jfa.2012.7
- Yang, Y., Tang, L., & Li, H. (2009) Vibration energy harvesting using macro-fiber composites. *Smart Mater. Struct.*, 18 (11), 115025. doi: 10.1088/0964-1726/18/11/115025