



HAL
open science

Temporal control of *Dickeya dadantii* main virulence gene expression by growth phase-dependent alteration of regulatory nucleoprotein complexes

A. Duprey, G. Muskhelishvili, Sylvie Reverchon, William Nasser

► To cite this version:

A. Duprey, G. Muskhelishvili, Sylvie Reverchon, William Nasser. Temporal control of *Dickeya dadantii* main virulence gene expression by growth phase-dependent alteration of regulatory nucleoprotein complexes. *Biochimica et Biophysica Acta - Gene Regulatory Mechanisms*, 2016, 1859 (11), pp.1470-1480. hal-01997030

HAL Id: hal-01997030

<https://hal.science/hal-01997030v1>

Submitted on 15 Nov 2021

HAL is a multi-disciplinary open access archive for the deposit and dissemination of scientific research documents, whether they are published or not. The documents may come from teaching and research institutions in France or abroad, or from public or private research centers.

L'archive ouverte pluridisciplinaire **HAL**, est destinée au dépôt et à la diffusion de documents scientifiques de niveau recherche, publiés ou non, émanant des établissements d'enseignement et de recherche français ou étrangers, des laboratoires publics ou privés.

1 **Temporal Control of *Dickeya dadantii* Main Virulence Gene Expression by Growth**
2 **Phase-Dependent Alteration of Regulatory Nucleoprotein Complexes**

3

4 Short title: **Control of Virulence Gene by Nucleoprotein Complex Alteration**

5

6 Alexandre Duprey^{1,2,3}, Georgi Muskhelishvili^{1,2,3}, Sylvie Reverchon^{1,2,3} and William
7 Nasser^{1,2,3*}.

8

9 ¹ Université Lyon 1, F-69622 Villeurbanne, France

10 ² INSA de Lyon, F-69621 Villeurbanne, France

11 ³ CNRS UMR5240 Microbiologie, Adaptation et Pathogénie, Villeurbanne, France

12

13 * To whom correspondence should be addressed. Tel: +33 (0)4 72 43 26 95; Fax: +33 (0)4
14 72 43 26 86; Email: william.nasser@insa-lyon.fr

15

16 **Abstract**

17 In bacteria, transcriptional control of important genes often involves numerous
18 factors, forming an intricate web of interactions. Due to this complexity, the effects of
19 transcriptional regulators are most often studied separately and little information is
20 available concerning their interactions. In this work using a combination of biochemical and
21 genetics approaches, we explore the regulation of *D. dadantii* major virulence gene *pelD*.
22 By dissecting the individual effects of binding sites for the abundant nucleoid-associated
23 protein FIS and the global transcriptional regulator CRP, as well as the impact of a newly
24 discovered divergent promoter, *div*, we provide an unprecedented level of detail on the

25 multifactorial regulation of gene transcription. We show that the temporal regulation of
26 *peID* is under the control of changing composition of higher-order nucleoprotein complexes
27 formed on binding of FIS and CRP to the *div* and *peID* promoters during the growth cycle,
28 that allows for sequential expression of *div* and *peID* in the early and late exponential
29 growth phases, respectively. Our results reveal the importance of “orphan” promoters in
30 gene regulation and show that the individual binding sites for a regulator can serve several
31 purposes and have different effects on transcription, thus adding a new level of complexity
32 to bacterial transcriptional regulation.

33

34 Graphical abstract

35

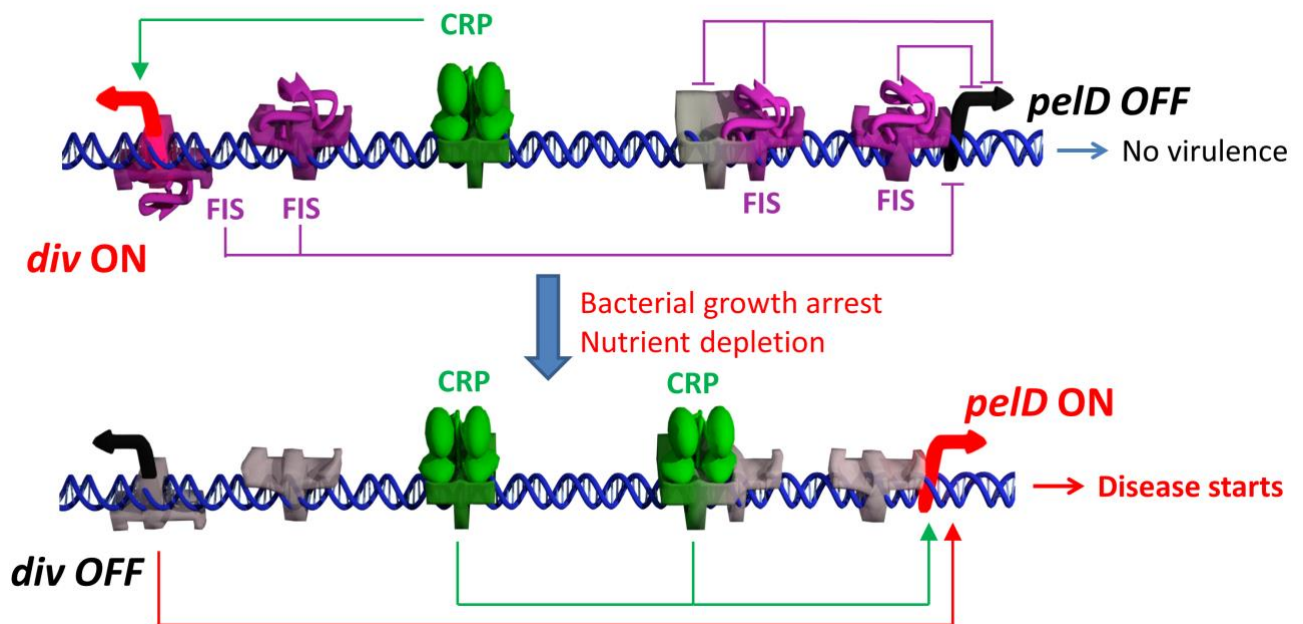

36

37

38 Highlights

- 39 - The transcriptional regulation of the *peID* virulence gene of *D. dadantii* is complex
- 40 - *peID* is regulated by a divergent orphan promoter *div*

- 41 - Individual FIS binding sites contribute differentially to *pefD* regulation
- 42 - CRP activates *pefD* and *div* promoters asymmetrically
- 43 - Nucleoprotein complexes change to create a sequential expression pattern of *pefD*
- 44 and *div*

45

46 **Keywords**

47 Transcriptional regulation, temporal regulation, Nucleoid-associated protein, FIS, CRP,
48 virulence gene

49

50 **Abbreviations**

51 TF: Transcription Factor

52 NAP: Nucleoid-Associated Protein

53 PGA: PolyGalacturonic Acid

54

55 **Introduction**

56 During the bacterial life cycle, the cells can be confronted with a variety of
57 environments differing in nutrient composition/availability, temperature, pH, salinity and
58 biotic interactions. Successful adaptation to these variable environmental conditions
59 requires appropriate phenotypic modifications. For this purpose, bacteria modify the gene
60 expression primarily at the level of transcriptional regulation, mediated by transcription
61 factors (TFs) binding at regulatory site(s) in the gene promoter regions. Whereas
62 repression by direct steric hindrance leading to promoter occlusion, and activation by
63 recruitment of RNA polymerase by a TF, are the most frequently described regulation
64 mechanisms [1], most genes are controlled by several TFs often competing for binding
65 sites in the gene regulatory region, or for interaction with RNA polymerase. Furthermore, a

66 small class of highly abundant TFs, known as nucleoid-associated proteins (NAPs),
67 regulate transcription via a variety of DNA topology-related mechanisms such as looping
68 [2], modulation of the spatial proximity of DNA-binding factors [3], and alteration of DNA
69 configuration [4]. This potential of utilising topological changes in DNA entails complex
70 regulatory mechanisms, which are not well understood.

71 FIS (factor for inversion stimulation) is one of the major NAPs in γ -proteobacteria,
72 capable of bending and looping the DNA and acting as a global regulator of transcription
73 and growth [5–7]. In addition to direct binding effects, FIS can influence global DNA
74 topology via regulation of DNA topoisomerases [8]. In particular, FIS acts to preserve the
75 moderately supercoiled forms, protecting the DNA from shifts towards the strongly relaxed
76 or highly negatively supercoiled extremes of the topological spectrum [9]. In *E. coli*, FIS is
77 highly abundant in early to mid-exponential growth phase when the bacterial growth rate is
78 high, whereas afterwards its level rapidly decreases becoming undetectable in stationary
79 phase [10]. FIS can activate transcription initiation by various mechanisms such as
80 recruitment of RNA polymerase at the promoter, induction of a conformational change in
81 the promoter DNA, or both [11]. However, FIS is a dual regulator and can also act as a
82 repressor counteracting the expression of inessential gene products during rapid growth
83 [11]. Thus, the changing concentration of FIS during the growth cycle can both activate
84 and repress the production of growth-related proteins and modulate the expression of
85 virulence factors in a growth phase-dependent manner [5,12] leading to a sequential
86 production of specific proteins during infection.

87 *Dickeya dadantii* is a phytopathogenic bacterium originating from tropical areas,
88 which has been recently identified as a causal agent of crop damage in temperate regions
89 (PQR - EPPO database on quarantine pests, available from

90 <http://www.eppo.int/DATABASES/pqr/pqr.htm>). *D. dadantii* has a broad host spectrum,
91 including economically important crops such as corn (*Zea mays*), potato (*Solanum*
92 *tuberosum*) and chicory (*Cichorium endivia*) [13]. The main infection symptom is soft rot,
93 which results from the action of extracellular enzymes, mainly pectate lyases (Pels)
94 degrading pectin, an essential component of the plant cell wall. *D. dadantii* produces more
95 than ten Pels with different biochemical properties and expression patterns [14,15]. The
96 synthesis of *D. dadantii* Pels is fine-tuned according to environmental or metabolic signals
97 [16], such as the presence of pectic compounds (via KdgR repressor) [17–19], and the
98 oxidative and acidic stresses [3,20]. It was shown that the sugar catabolism regulator
99 complex cAMP-CRP is the main direct activator of the *pel* genes [19,21]. Furthermore, the
100 abundant NAP FIS modulates the expression of the *pel* genes in a growth phase-
101 dependent manner [22]. Both these factors bind to the *pel* gene regulatory regions making
102 these genes ideal for exploring how bacteria integrate various mechanisms to control
103 transcription initiation. Among the Pels, PelD production is most strongly affected by pectin
104 derivatives and growth-phase, which makes it a key element in the induction of *D. dadantii*
105 virulence [23,24]. The *pelD* gene is inactive during exponential growth when the bacterial
106 density is low, and strongly expressed in early stationary phase when the bacterial density
107 is sufficient to overcome the plant defence mechanisms. Previously, it was demonstrated
108 that FIS binds two regions in *pelD* [25], but their impact in modulating *pelD* expression
109 remains unclear. Furthermore, it was observed that RNA polymerase binds at the *pelD*
110 upstream AT-rich region more tightly than at the *pelD* core promoter itself [25,26]. Notably,
111 binding of CRP and FIS induces overlapping protection patterns in the region between the
112 upstream RNA polymerase binding site and the *pelD* promoter. However, neither the role
113 of these overlapping binding sites, nor the impact of upstream RNA polymerase binding

114 site on *peID* transcription have been elucidated.

115 In this work, by combining *in vivo* transcriptional activity assays using reporter
116 genes with *in vitro* biochemical studies, we describe the complexity of the *peID* promoter
117 control showing that the key component in the temporal pattern of *peID* expression is the
118 dynamic balance between the binding of RNA polymerases at either *peID* or a newly
119 discovered upstream divergent promoter modulated by FIS, CRP and DNA topology. By
120 integrating the individual effects of regulators resolved at a single binding site scale with
121 the data on polymerase binding site occupation, we propose a model of *peID*
122 transcriptional regulation during the growth cycle.

123

124 **MATERIALS AND METHODS**

125 **Bacterial strains, plasmids, media, culture conditions and molecular biology** 126 **methods**

127 *Escherichia coli* and *Dickeya dadantii* were cultured at 37 °C in LB (Luria-Bertani, [27]) and
128 30 °C in M63S (M63 [27] supplemented with sucrose (S) 0.2% w/v), respectively.
129 Antibiotics were used at the following concentrations: Ampicillin 100 µg/mL,
130 Chloramphenicol 20 µg/mL or 4 µg/mL for *E. coli* and *D. dadantii*, respectively. Liquid
131 cultures were grown in a shaking incubator (150 r.p.m.). Media were solidified by the
132 addition of 1.5% agar (w/v).

133 Plasmids from the pKD series were obtained either by direct synthesis (pKD0, pKD1,
134 pKD2, pKD3, pKD4 and pKD5) or by QuickChange mutagenesis. pKD7 was mutated from
135 pKD0 using primers *peIDfis1bismut* FW and *peIDfis1bismut* REV. pKD9 and pKD10 were
136 mutated from pKD5 and pKD7, respectively, using primers *peIDFis1mutFW* and
137 *peIDFis1mutREV*. pKD24 was mutated from pKD0 using primers 35rev v2 FW and 35rev

138 v2 REV (Table S1). pKD26 and pKD27 were mutated from pKD0 using primers 395/396
139 and 397/398, respectively. pKD28 was mutated from pKD26 using primers 397/398.
140 Plasmid pJV was constructed by amplifying the double terminator B0014
141 (http://parts.igem.org/Part:BBa_B0014) from the plasmid pIG50 [28] using primers B0014
142 FW and B0014 REV. The EcoRI-PvuII PCR product was then cloned into pJCD0 [29],
143 yielding a plasmid with terminators on both sides suitable for *in vitro* transcription. Like all
144 pUC-derived plasmids, pJV bears the noncoding RNA-I inside its replication origin which
145 was used as an internal standard.
146 Plasmids from the pPD series, pID series, pJD series, pLD0 and pND0 were obtained by
147 restriction assembly of the corresponding pKD insert into pProbe AT', pProbe AT' (with
148 different restriction sites for the pPD or pID series, see Table S1, such that *peID* controls
149 *gfp* transcription in the pPD series, and *div* controls *gfp* transcription in the pID series),
150 pJV, pUCTer-Luc-Cm or pNB4, respectively, using standard molecular biology protocols
151 [30].

152

153 ***In vivo* transcriptional activity measurements**

154 Overnight bacterial precultures in M63S were diluted to an OD₆₀₀ of 0.03 in M63S + CaCl₂
155 0.1 mM + Polygalacturonic acid (PGA) 0.2 % w/v (*Dickeya dadantii*) or LB (*E. coli*). The
156 medium was supplemented with D-luciferin (Perkin-Elmer, USA) at a final concentration of
157 450 µg/mL when working with Luc. When required, novobiocin was added at the start of
158 the culture, at a final concentration of 25 µg/mL.

159 For fluorescence and luminescence, 200 µL of this dilution were then distributed in a
160 Cellstar 96-well plate (655090, Greiner Bio-one, Germany). The OD₆₀₀, fluorescence and
161 luminescence were monitored for 48h using an Infinite 200 pro plate reader (Tecan,

162 Switzerland). For fluorescence, the excitation and emission wavelengths were 485 and
163 530 nm, with a bandwidth of 9 and 20 nm, respectively.

164 The normalised fluorescence is defined as the ratio of the fluorescence of the considered
165 promoter in early stationary phase (which corresponds to 20 h growth for a WT strain) by
166 the OD₆₀₀, normalised to the ratio calculated for the WT promoter in a WT strain (arbitrarily
167 set as 100).

168 mRNA levels were computed from fluorescence data using the model described in [31].
169 Due to the stability of the Gfp used (> 20 days half-life, [32]), degradation was neglected.
170 Because *peID* and *div* are not expressed at the same time (see Fig 4a), the maximum
171 expression of both promoters is usually represented in the figures, which means early log
172 growth phase for *div* and late log for *peID*.

173

174 For GUS, the specific beta-glucuronidase activity of the whole culture was measured at a
175 comparable growth stage using the method described in [33].

176

177 **DNase I footprinting**

178 For quantitative fluorescent DNase I footprinting, the protocol published in [19] was
179 modified as follows. Fluorescently labelled primers DNase *peI* FW and DNase *peI* REV
180 (Table S1) were used to amplify the *peID* regulatory region from plasmids of the pKD
181 series by PCR. A clean-up was then performed using the Nucleospin Gel and PCR Clean-
182 up kit (Macherey-Nagel, the Netherlands). 50 ng of the labelled DNA was used per
183 reaction, which represents a 2-fold increase in DNA quantity compared to radioactivity.
184 Protein concentrations were adapted accordingly. In the end, the samples were analysed
185 on an AB 3730 XL capillary sequencer (Applied biosystems, USA). Peak areas were

186 normalised to the total fluorescence of each sample.

187

188 **Potassium permanganate footprinting**

189 Potassium permanganate reactions were performed on supercoiled plasmid, in the
190 conditions described in [25]. The reaction products were divided into 2 equal parts. 15
191 cycles of primer extension were performed with Phusion polymerase (New England
192 Biolabs, USA) with the fluorescently labeled primers DNase pel REV, for one part, and
193 Bla3B4 fluo for the other part (which was used as a standard). After the primer extensions,
194 both reactions were mixed together and analysed on an AB 3730 XL capillary sequencer
195 (Applied biosystems, USA).

196 For *in vivo* reactivity assays, *D. dadantii* wild type cells harbouring plasmid pKD0,
197 containing the full *pelD* and *div* promoters, were grown in minimal M63 medium containing
198 sucrose (0.2%, W/V) and polygalacturonate (0.2%, W/V) until the required stages. Then
199 KMnO₄ was added at 10 mM (final concentration) for 1 min as described [34] to the batch
200 cultures growing at 30°C under vigorous shaking. The cells were collected by
201 centrifugation and the plasmid was extracted with Machery Nalgel Spin Miniprep Kit. The
202 isolated plasmids (125 ng) were used as template for 5 cycles of primer extension with
203 Taq polymerase (New England Biolabs, USA) and ³²P-labeled primer 300 (Table S1).
204 Reaction products were then loaded onto a sequencing gel.

205

206 ***In vitro* transcription**

207 Supercoiled pJD plasmids were incubated with CRP (purified from *D. dadantii*, used at 100
208 nM concentration unless indicated otherwise) and RNA polymerase (commercial
209 holoenzyme from *E. coli* purchased from Epicentre, used at 40 nM concentration unless

210 indicated otherwise) for 5 min at 30 °C in a reaction buffer containing 10 mM Tris-HCl pH
 211 8, 0.5 mM dithiothreitol, 150 mM KCl, 200 μM cAMP and 0.1% (v/v) Nonidet P-40.
 212 Transcription was initiated by the addition of 0.2 mM ATP, GTP and CTP, 0.01 mM cold
 213 UTP and 0.1 μCi/μL [α-P³²]-UTP and allowed to proceed for 15 min. Reactions were
 214 stopped by the addition of an equal volume of 20 mM EDTA, 0.025% (w/v) bromophenol
 215 blue and 0.025% (w/v) Xylene cyanol in formamide and loaded on a sequencing gel.

216

217 RESULTS

218 Identification and inactivation of the FIS binding sites

219 The cooperative binding of CRP at two distinct sites in the *peID* regulatory region
 220 was established in a previous study [25]. Furthermore, it was found that binding of FIS
 221 resulted in protection of two DNA regions (from position -150 to -119 and -48 to +7 relative
 222 to the transcription initiation site at +1), one of which overlapped the *peID* promoter (Fig 1).
 223 However, the exact number of FIS binding sites and their functional role remained
 224 unknown.

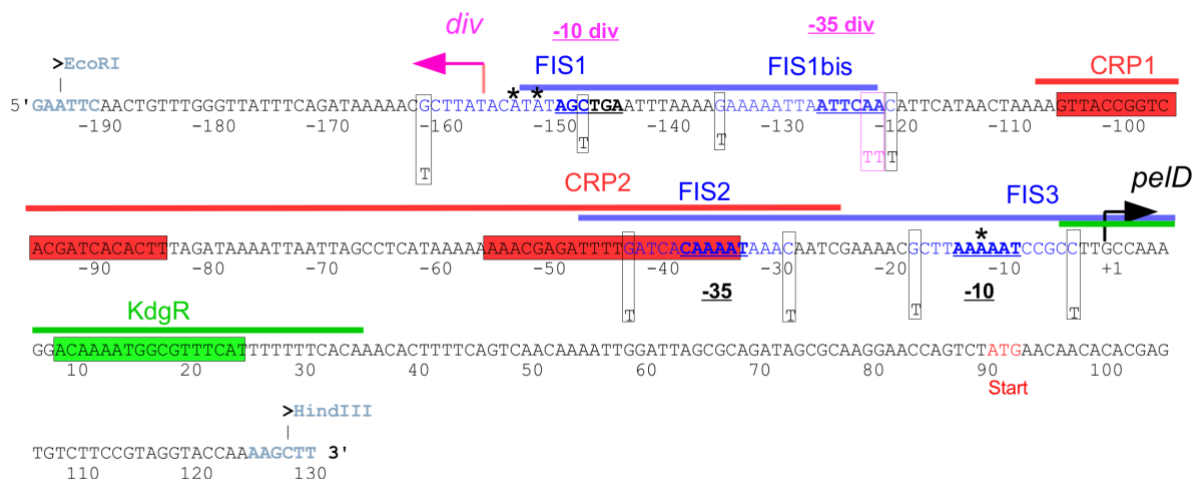

225

226 **Fig 1: Structure of the *peID* regulatory region.** The sequence of the *peID* regulatory region is annotated

227 with the experimentally verified binding sites of CRP (red box) and KdgR (green box) (19, 26). The -10 and -
228 35 elements are in bold and underlined, the translational start codon is in red letters, and the transcription
229 initiation site is indicated by a broken arrow [26]. The positions of the -35, -10 elements and initiation site of
230 the *div* promoter are indicated in pink. The two regions protected by FIS [25] and harbouring the four
231 identified FIS binding sites are indicated by blue solid lines. Mutated positions are enclosed in a rectangle
232 (black and pink for inactivation of FIS sites and *div* promoter, respectively). The region protected by CRP
233 [25] and harbouring two CRP binding sites is indicated by red solid line. The gray boxes indicate A/T tracts
234 centered at +9, +18 and +26 downstream of *div* initiation start site. Stars indicate the main Ts targeted by
235 potassium permanganate in Fig 6, which are situated on the reverse strand.

236

237 Consequently, a bioinformatic search for the FIS binding consensus on the *pefD*
238 regulatory region was performed via Virtual Footprint ([http://prodoric.tu-](http://prodoric.tu-bs.de/vfp/vfp_promoter.php)
239 [bs.de/vfp/vfp_promoter.php](http://prodoric.tu-bs.de/vfp/vfp_promoter.php) [35]), using the weight matrix established for *E. coli*. Only the
240 sites with a score greater than 3.00 were considered (the mean score for referenced FIS
241 binding sites being 2.87). This highlighted three binding sites, which were designated
242 FIS1, FIS2 and FIS3 (Fig 1). FIS2 and FIS3 matched the previously determined FIS I
243 experimental footprint [22], whereas FIS1 was located upstream partially overlapping the
244 FIS II experimental footprint [25]. Manual examination of the sequence revealed a 4th
245 potential site, named FIS1bis, that was not detected by Virtual Footprint due to its
246 increased length (16 bp) compared to the consensus FIS site (15 bp). The position of
247 FIS1bis matches the previously identified experimental FISII footprint [25]. Among these
248 four putative FIS binding sites, both FIS1 and FIS1bis are located far upstream, whereas
249 FIS2 and FIS3 overlap the *pefD* core promoter. Importantly, FIS2 also overlaps the CRP2
250 binding site. These four putative sites were inactivated separately, or in various
251 combinations, by substituting the conserved G at the position 1 and the conserved C at the

252 position 15 by Ts [36], as described in Fig 1.

253 The success of inactivation was confirmed by DNase I footprinting demonstrating a
254 disappearance of protection by FIS for all of these sites (Fig S1a), except for FIS1bis
255 which showed barely detectable FIS binding on the WT template. Inactivation of FIS1,
256 FIS2 or FIS3 did not noticeably modify the FIS footprints at the other sites (Fig S1a), which
257 implies that binding of FIS at these sites is largely independent. In addition, major
258 differences in affinity were observed, with FIS2 and FIS3 having a higher affinity than FIS1
259 and Fis1bis (Fig S1b).

260

261 **The pProbe-Gfp reporter system allows accurate quantification of promoter activity** 262 **in *D. dadantii***

263 Previously, most of the quantitative transcriptional activity measurements in *D.*
264 *dadantii* have been performed by using beta-glucuronidase (GUS) genomic insertions [22],
265 or by quantitative RT-PCR (q-RT-PCR) [3,37]. Both methods are relatively time-
266 consuming, due to the need to recombine the numerous transcriptional fusions into the
267 chromosome or to extract RNA, respectively. Alternatively, heterologous GUS fusions on
268 plasmids have been successfully used in *E. coli* [38]. We explored two reporter genes,
269 Green fluorescent protein (Gfp) and Firefly luciferase (Luc), which would allow to perform
270 easy, plasmid-based, real-time and automated measurements of gene expression in *D.*
271 *dadantii*. Gfp is a highly stable protein (> 20 days half-life, [32]), while GUS is moderately
272 stable (4h half-life, [39]) and Luc is an unstable protein (10 min half-life, [40]). The
273 expression of a *peID* transcriptional fusion with each reporter (Fig S2) in *D.dadantii* wild
274 type (WT) and its *fis* derivative backgrounds was measured. We found that the amplitude
275 of the differences was negatively correlated with the stability of the proteins (ranging from

276 a fold change of 1.4 for Gfp to 7.0 for Luc). However this increased sensitivity comes at the
277 cost of decreased accuracy, especially in the *fis* mutant, with the coefficient of variation
278 being 20% for Luc, but only 7% for Gfp. This results in weaker statistical tests for the Luc
279 system e.g. a Welch test comparing WT to *fis*- conditions gives $p < 10^{-9}$ for Gfp but only
280 $p < 10^{-3}$ for Luc (n=12 per condition for each reporter system). Consequently, to obtain
281 reproducible results, the Gfp system was used for further measurements, since despite
282 lower sensitivity even small (but statistically significant) differences in fluorescence could
283 be assumed to be biologically relevant.

284

285 **The *peID* FIS binding sites are partially redundant**

286 We next investigated the role of the different FIS binding sites in the modulation of
287 *peID* expression. To achieve this, plasmid-borne *gfp* transcriptional fusions were
288 constructed with the mutated *peID* promoters and transformed in *D. dadantii* wild type
289 (WT) and *fis* mutant strains. The fluorescence of the cells was measured in early
290 stationary phase, when the transcription of *peI* genes is maximal [41]. The results are
291 shown in Fig 2.

292

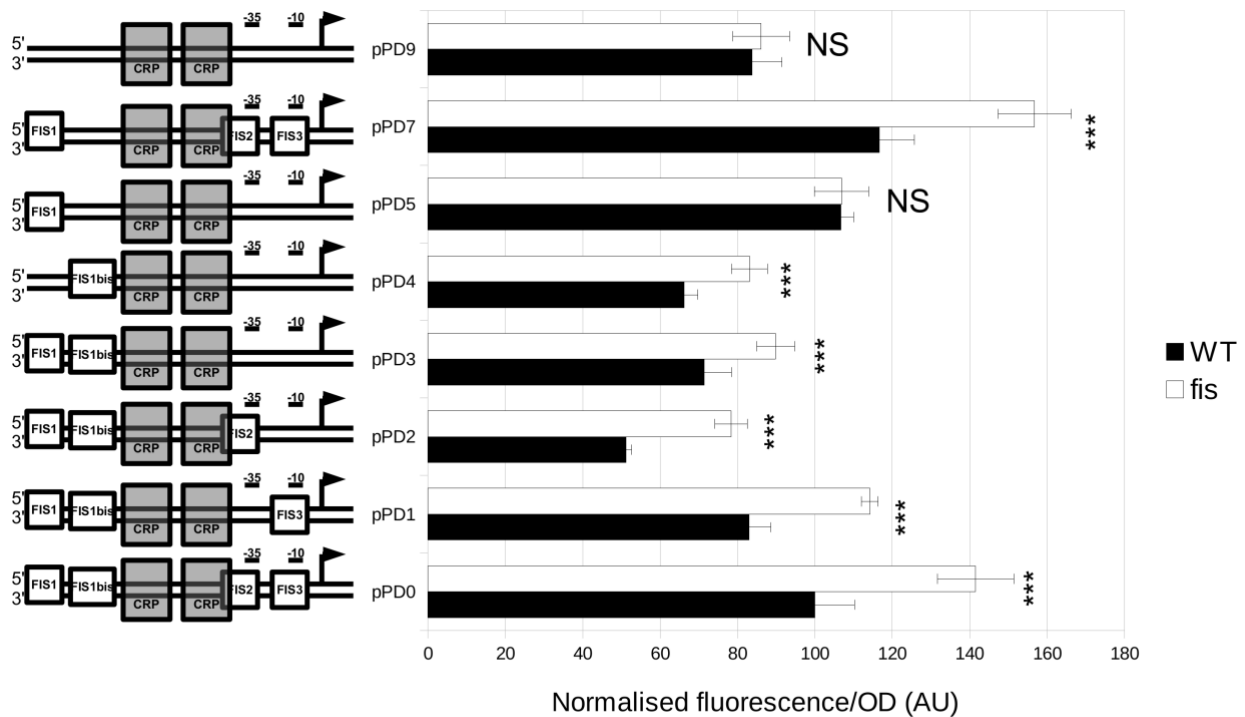

293

294 **Fig 2: Transcriptional activity of various *peiD* promoter constructs in *D. dadantii* wild type and *fis***
 295 **mutant backgrounds.** *D. dadantii* wild type and *fis* strains transformed with various *peiD* constructs
 296 (pProbe-Gfp plasmids D0 to D9 represented schematically on the left) were cultured in 96 well plates and the
 297 normalised fluorescence was determined in early stationary phase. Data represents the mean of 7 to 34
 298 replicates and error bars represent the standard deviation. NS: not significant; ***: $p < 0.001$ (Tukey's HSD
 299 test). Note that some of the introduced mutations affect the basal *peiD* promoter activity due to the overlap
 300 between the FIS binding sites and the core promoter sequence.

301

302 We found that as expected, FIS acted as a repressor [22], since the *peiD* activity
 303 was significantly increased in the *fis* mutant (see D0 in Fig 2). Inactivating either FIS1bis,
 304 FIS2 or FIS3 separately (compare D0 with D1, D2 and D7) had no significant impact on
 305 the repression by FIS (the fold-change remained constant at 1.40). Simultaneous
 306 inactivation of FIS2 and FIS3 (D3) alleviated the repression by FIS from 1.40-fold to 1.25-
 307 fold ($p < 10^{-4}$, t-test for contrasts), and this residual repression can be attributed to the intact

308 upstream sites. Furthermore, inactivation of FIS1, FIS2 and FIS3 had a similar effect as
309 inactivation of FIS2 and FIS3 (compare D4 and D3), suggesting that FIS1 does not play
310 any role in *peID* repression *in vivo*. However, only the simultaneous inactivation of FIS1bis,
311 FIS2 and FIS3 resulted in a complete elimination of repression by FIS, comparable to the
312 construct in which all FIS binding sites were inactivated (compare D5 and D9). It thus
313 appears that FIS2, FIS3 and FIS1bis are required for full repression of the *peID* promoter
314 by FIS *in vivo*. *In vitro* transcription reactions performed with *peID* plasmid constructs
315 yielded similar results (Fig S3). Inactivation of both FIS2 and FIS3 together was necessary
316 to fully remove the repression of *peID* by FIS, but, unlike *in vivo*, FIS1bis inactivation
317 showed no effect, in keeping with the barely detectable occupancy of FIS1bis site *in vitro*
318 (Fig S1).

319

320 **FIS competes with binding of CRP only at the CRP2 site**

321 Whereas the occupancy of either of the strong FIS2 and FIS3 sites overlapping the
322 RNA polymerase (RNAP) recognition elements appears sufficient to prevent RNAP
323 binding at the *peID* promoter, FIS2 also overlaps the CRP2 binding site (see Fig 1),
324 suggesting a potential competition between FIS and CRP for promoter binding. Therefore,
325 quantitative DNase I footprinting was performed to examine whether the presence of FIS
326 had an impact on the CRP footprint at the CRP2 site (Fig 3). On the wild-type regulatory
327 region, a footprint by CRP at the CRP2 site was visible only in the absence of FIS,
328 whereas on templates with inactivated FIS2 (or both FIS2 and FIS3) site(s), the protection
329 of CRP2 site by CRP was observed despite the presence of FIS. In contrast, the protection
330 of CRP1 site was independent of the presence of FIS on both the wild type and mutated
331 templates (Fig S4). This suggests that binding of FIS at FIS2 specifically interferes with

332 occupation of the CRP2 site, whereas FIS does not interfere with CRP binding at CRP1.
 333 We infer that binding of FIS represses the *pefD* promoter activity by competing not only
 334 with RNA polymerase binding, but also with binding of the activator CRP.

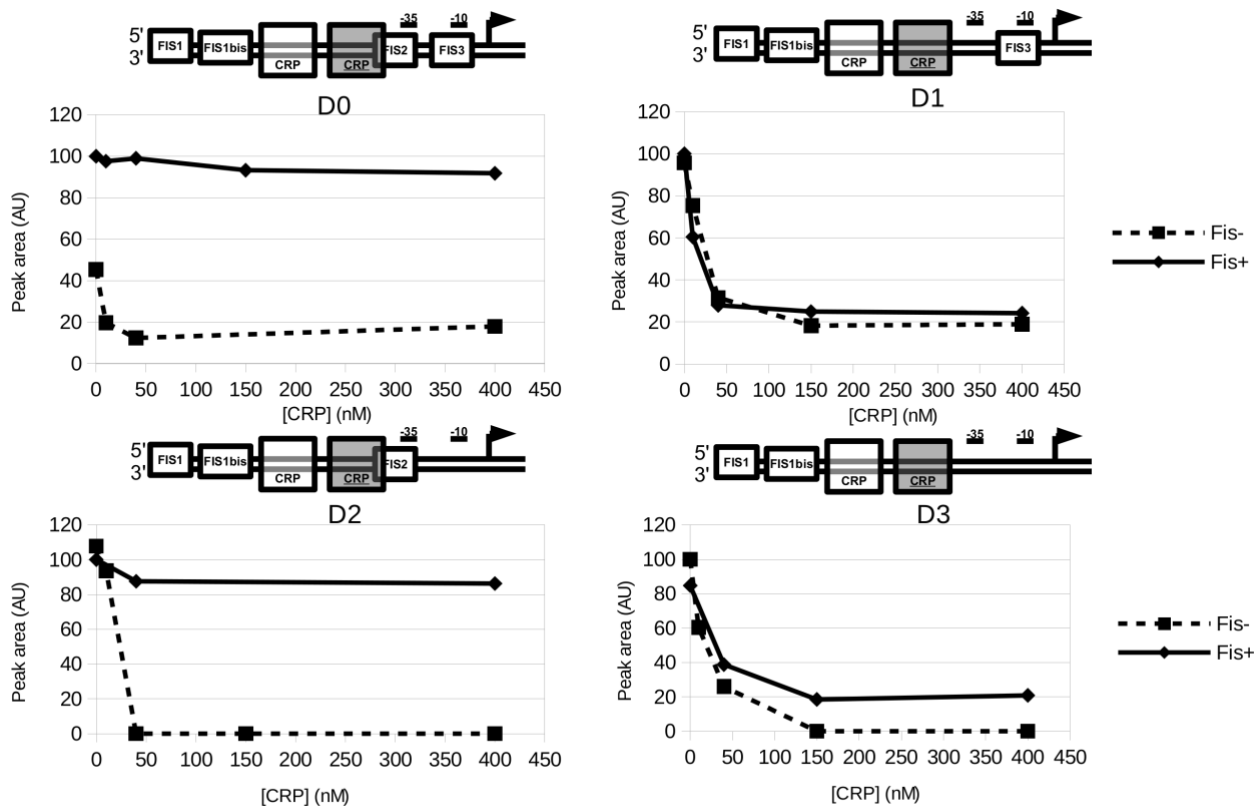

335

336 **Fig 3: Modification of the CRP2 binding by FIS.** Quantitative DNase I footprinting using fluorescently
 337 labelled linear *pefD* DNA fragments lacking one or both of the FIS binding sites overlapping the *pefD*
 338 promoter. The reactions were performed in the presence or absence of FIS (150 nM) and with increasing
 339 concentrations (from 0 to 400 nM) of CRP. The area of the peaks at one position within the CRP2 binding
 340 site (at position -29 relatively to the transcription start site) is represented for different CRP concentrations.
 341 This position is protected by CRP and becomes hypersensitive in presence of FIS. Absence of variation in
 342 this area (as observed with D0 and D2 in presence of FIS) means that CRP cannot bind the corresponding
 343 site. Consistent results were obtained also with two other positions analysed within the CRP2 footprint (-47
 344 and -21).

346 The upstream divergent promoter is activated by supercoiling and repressed by FIS

347 The upstream FIS binding sites (FIS1 and FIS1bis) are located too far upstream of
348 *peID* core promoter to be directly involved in competition with RNA polymerase for binding.
349 However, previous DNase I footprinting experiments have revealed that this upstream
350 region contains a high affinity binding site for RNA polymerase (extending from pos. -142
351 to -104) in divergent orientation to *peID* [26]. Indeed, recent RNAseq data analysis (*Jiang*
352 *et al.* in preparation) confirmed by our *in vitro* transcription experiments identified a
353 divergent transcript initiating from *peID* upstream region and devoid of any meaningful
354 ORF. We propose that this region comprises a divergent promoter (denoted hereafter as
355 *div*), which potentially could influence the expression of *peID* and also be regulated by FIS
356 and CRP *via* FIS1/FIS1bis and CRP1 sites, respectively. Indeed FIS1/FIS1b overlap the -
357 10 and -35 elements of the *div* promoter, whereas CRP1 is centred at -60.5 with respect to
358 the *div* transcription initiation site (Fig 1). This latter organisational feature is characteristic
359 of class I CRP-dependent promoters, suggesting that CRP1 site might be used for
360 activation of both the *peID* [26] and *div* promoters by CRP.

361 To examine the relationship between the *peID* and *div* promoters we measured the
362 amount of mRNA produced from both promoters on the plasmid constructs *in vivo*. We
363 found that the peak of *peID* expression observed as expected, on transition to stationary
364 phase, was preceded by a peak of *div* expression, observed early during the exponential
365 growth phase (Fig 4a), whereby the *div* promoter showed significantly lower expression
366 levels than *peID*. Measurements of the untwisting of the *div* and *peID* promoters using *in*
367 *vivo* KMnO₄ reactivity assay (see Materials and methods) confirmed that the peak of *div*
368 promoter untwisting during exponential phase preceded that of *peID* occurring on transition

369 to stationary phase (Fig S5). Interestingly, whereas these two promoters were sequentially
 370 activated during growth of *D. dadantii*, the decline of *div* activity clearly coincided with
 371 activation of *peID*. We asked whether this correlation – given the close proximity of the
 372 promoters - indicated a possible link in their regulation mediated by binding proteins.
 373 Indeed, not only was the expression of both *peID* and *div* increased in the *fis* mutant, but
 374 also the peak of *div* expression was shifted to the right along the growth curve (Fig 4a).

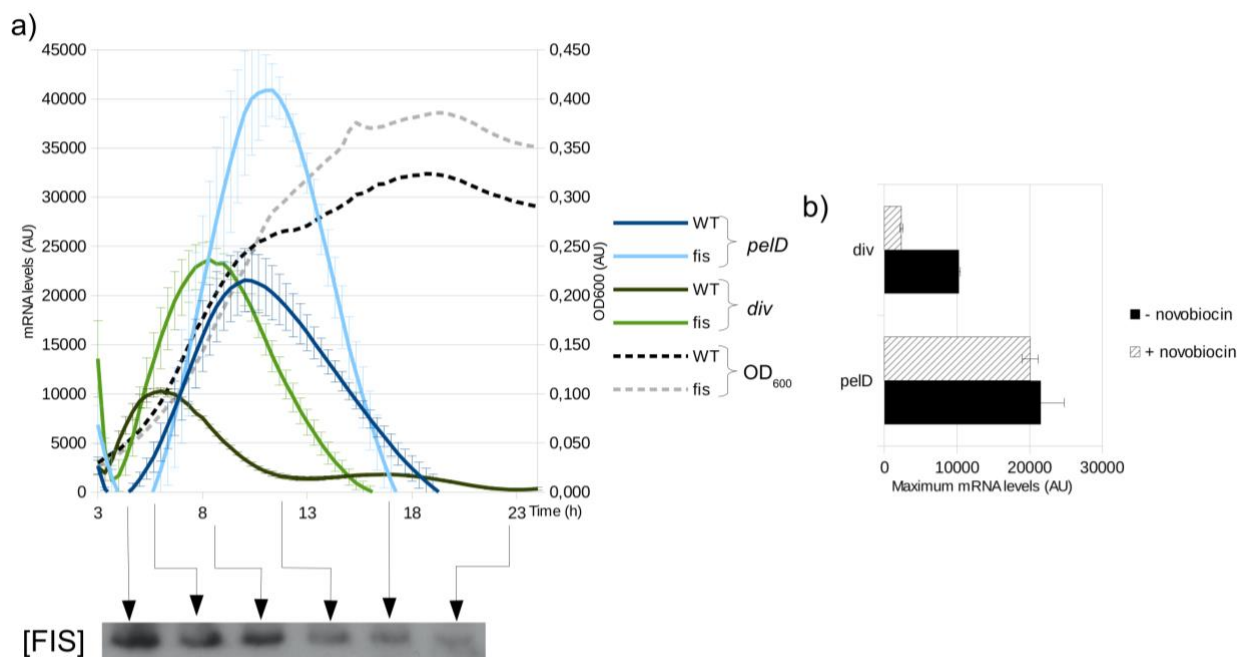

375

376

377 **Fig 4: Transcriptional regulation of the *div* promoter.** *Dickeya dadantii* wild type and *fis* mutant cells
 378 were transformed with constructs carrying *peID* promoter-*gfp* or *div* promoter-*gfp* fusions and cultured in 96
 379 well plates. Sublethal concentrations of novobiocin (25 µg/mL) were added at the start of the culture. a) The
 380 mRNA levels produced from different constructs in wild type and *fis* mutant cells were computed from
 381 fluorescence data as previously described [31]. Western blots indicating the levels of FIS at the indicated
 382 time points during the growth cycle. b) Maximum calculated mRNA levels obtained during the experiment in
 383 the presence or absence of novobiocin.

384

385 It is noteworthy, that despite the de-repression of *div* promoter in the *fis* mutant, its
386 activity sharply declined during the transition of cells to stationary phase, which is
387 characterised by decrease in global DNA superhelicity (Fig 4a). Since unlike *pe/D*, the
388 peak of *div* activity was observed in early exponential growth phase characterised by high
389 levels of negative DNA superhelicity, we compared the response of the *div* and *pe/D*
390 promoters to DNA relaxation (Fig 4b). We found that in contrast to *pe/D* promoter, the *div*
391 promoter activity was substantially decreased on DNA relaxation by novobiocin, a
392 coumarin drug inhibiting the generation of negative superhelicity by DNA gyrase [42].
393 Therefore, whereas FIS clearly represses *div* promoter activity (Fig 4a), the observed
394 reduction of *div* transcription later during the growth cycle (observed in both the wild type
395 and *fis* mutant) could be explained by relaxation of DNA on transition of the cells to
396 stationary phase [43].

397

398 **The two CRP binding sites synergistically activate both *pe/D* and *div***

399 To investigate the impact of the CRP1 and CRP2 sites in *pe/D* and *div* promoter
400 expression we inactivated these sites either separately or together (see legend to Fig 5).
401 The resulting constructs were used to quantify the promoter expression in the wild type
402 strain. The data are shown in Fig 5. We found, as expected, that inactivation of either
403 CRP1 or CRP2 separately strongly impairs the *pe/D* promoter activity. However, this effect
404 is more pronounced in the absence of CRP2. This observation is consistent with observed
405 higher affinity of CRP2 compared to CRP1 (compare Fig 3 and Fig S4) and its optimal
406 position (centred at -42.5bp) for activating the *pe/D* promoter. It thus appears that whereas
407 CRP2 is the main activator site, both CRP binding sites synergistically activate the *pe/D*
408 promoter. At the same time, the CRP1 and CRP2 sites also act synergistically on the *div*

409 promoter but in this case the impact of CRP1 site is predominant, in keeping with its
 410 optimal location (-60.5bp) with regard to the *div* transcription initiation site (see Fig 1).
 411 Thus, binding of CRP to CRP1 and CRP2 sites synergistically modulates both *peID* and
 412 *div* promoter expression, although the impact of individual sites at each promoter is
 413 different.

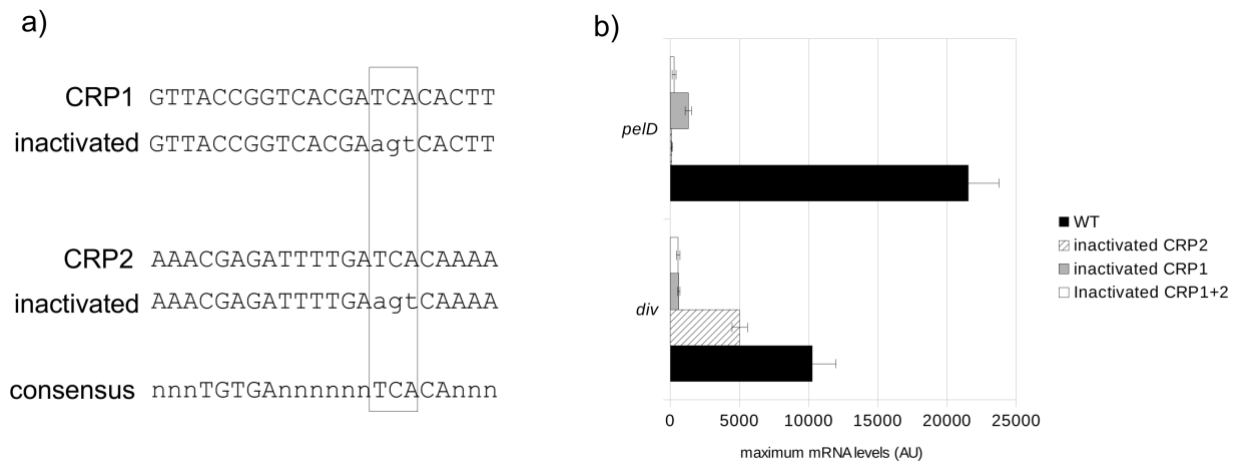

414
 415 **Fig 5: Individual contributions of the CRP1 and CRP2 sites on *peID* and *div* expression.** (a) CRP sites
 416 were inactivated by site-directed mutagenesis, substituting several of the most conserved nucleotides in the
 417 consensus, using the same approach as for FIS sites (see methods). (b) Expression of the mutated
 418 promoters was measured as in figure 6b. Data represents the mean of 10 replicates and error bars indicate
 419 standard deviation.

420
 421 **The divergent promoter potentially competes with *peID* for RNA polymerase binding**
 422 ***in vitro***

423 To gain more insight into the relationship between the *div* and *peID* promoters we
 424 investigated *in vitro* the promoter opening using potassium permanganate reactivity assay.
 425 In these experiments, conducted with various concentrations of RNA polymerase and
 426 CRP, we observed that under conditions of low transcriptional activity (low concentrations

427 of both CRP and RNAP), the opening of both promoters was similar, whereas under
 428 conditions favouring high levels of transcription (high concentrations of both RNAP and
 429 CRP), an up to 6-fold stronger reactivity to KMnO_4 is observed at the *div* promoter
 430 compared to the *peID* promoter (Fig 6). These results suggest that under conditions
 431 supporting active transcription *in vitro*, the *div* promoter can gain an advantage over the
 432 *peID* promoter in binding RNA polymerase.

433

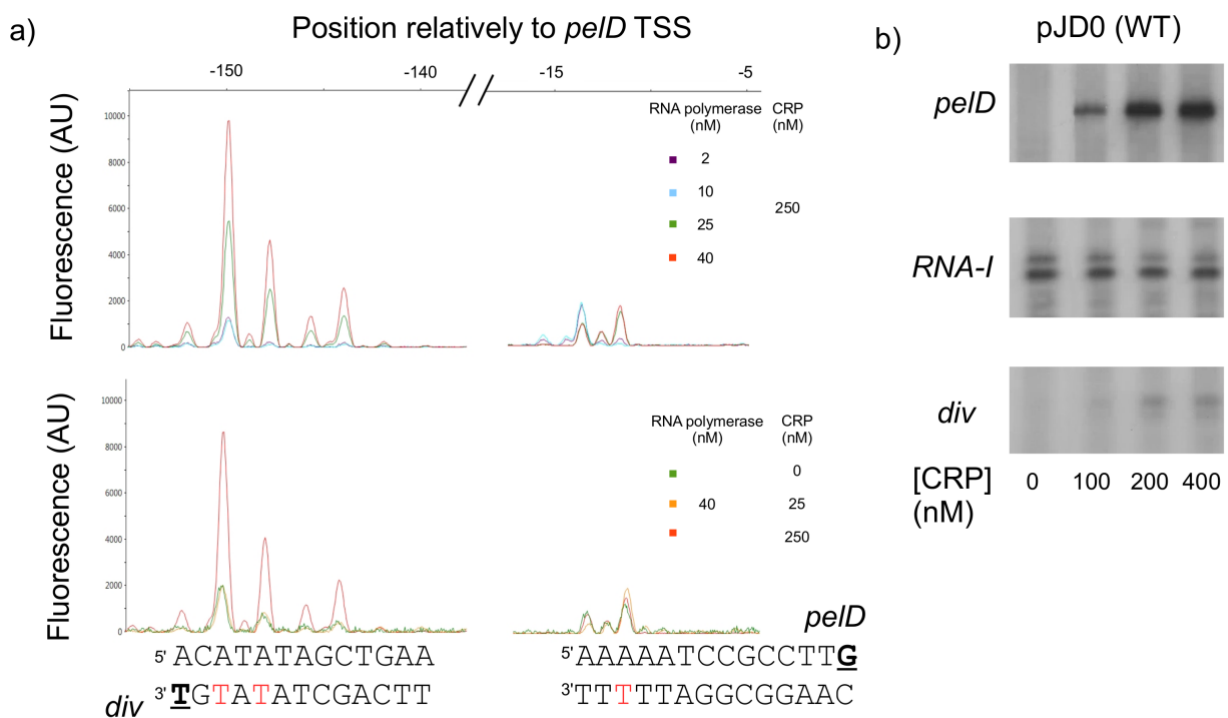

434

435 **Fig 6: Preferential binding of RNA polymerase at *div* does not correlate with stronger transcription.** a)
 436 Potassium permanganate reactivity of the supercoiled *peID* regulatory region in the presence of varying
 437 concentrations of CRP and RNA polymerase as indicated on the right of the figure. The *peID* and *div*
 438 transcription initiation sites are underlined in the corresponding sequences shown below the reactivity
 439 profiles. Both strands are shown and attacked Ts are indicated in red. The capillary electrophoresis
 440 fluorescence profiles were normalised to the *peID* peaks and overlaid with the position of each peak
 441 relatively to the *peID* transcription start site. b) *In vitro* transcription using the supercoiled wild type *peID*
 442 promoter was performed in the presence of 40 nM RNA polymerase and varying concentrations of CRP. The

443 *peID*, RNA-I (internal standard) and *div* transcripts are shown.

444

445 In the *in vitro* transcription reactions performed in parallel, we found that although
446 both the *peID* and *div* promoters were activated by CRP, this effect was much more
447 pronounced for the former (Fig 6b), probably due to the strong activating effect of the high-
448 affinity binding CRP2 site centred at classical -42.5 bp with respect to the *peID* promoter
449 transcription startpoint. The discrepancy between the efficient opening and low
450 transcriptional activity of the *div* promoter suggests that this promoter may act as a trap for
451 RNA polymerase molecules readily forming stable open complexes but only rarely
452 initiating transcription. One plausible explanation for this behavior is the strong -35
453 hexamer (TTGAAT) of *div*, which combined with further stabilization of polymerase binding
454 by CRP (especially via CRP1 site) could be detrimental to promoter clearance [44].

455

456 **Inactivation of *div* reduces the *peID* activity *in vitro***

457 To directly assess the effect of the *div* promoter on *peID* activity we compared the
458 promoter function of wild type *peID* construct and a construct with a mutation (D24)
459 inactivating the -35 element of the *div* promoter and demonstrating a strong reduction of
460 *div* opening by KMnO₄ reactivity assay (Fig 7a).

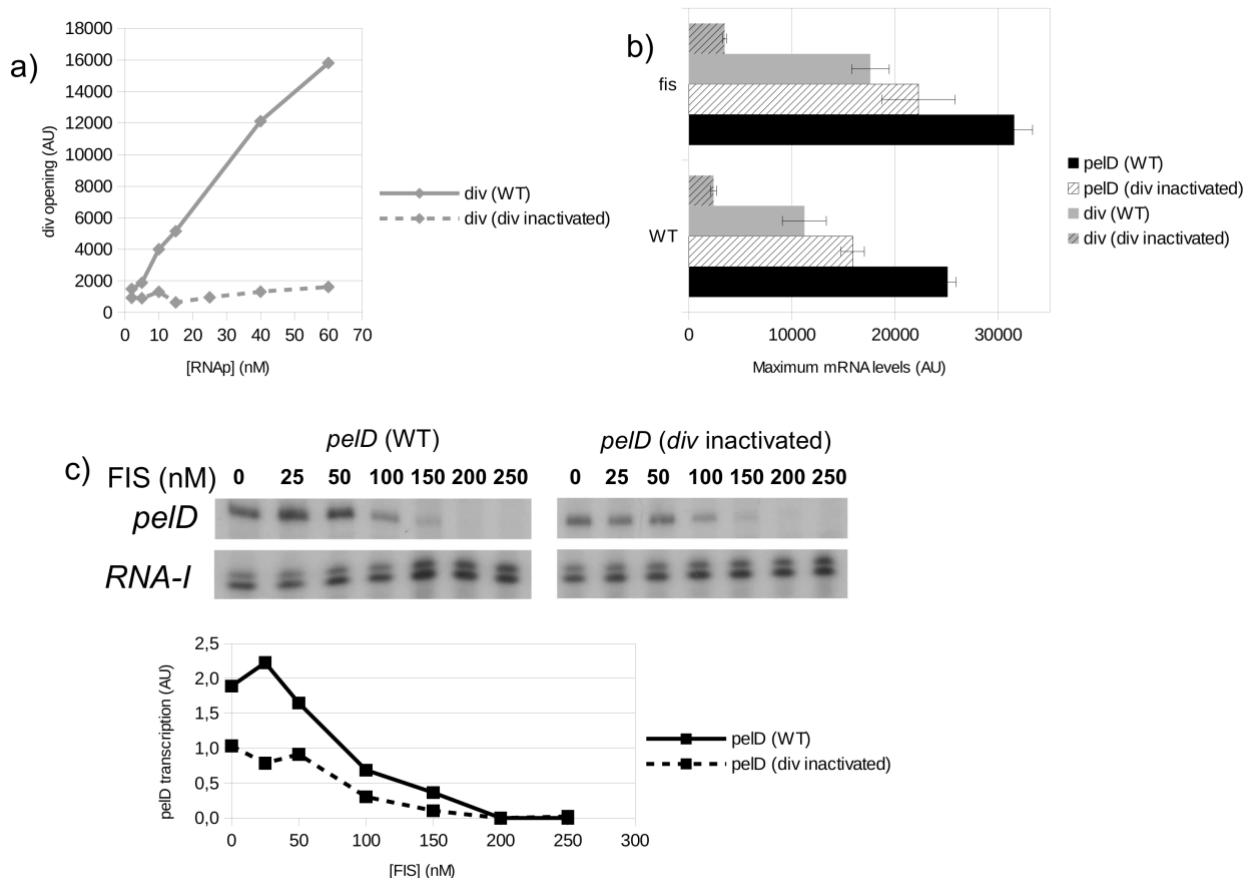

461

462 **Fig 7: Impact of *div* on *peID* transcription.** The *div* promoter was inactivated by mutating the -35 box (see
 463 Fig 1) and the impact of this mutation was assessed. a) Potassium permanganate reactivity (opening) of the
 464 wild type and inactivated *div* promoter in the presence of 100 nM CRP and varying concentrations of RNA
 465 polymerase. The promoter opening was quantified as described in the legend to Fig 4. b) *In vivo* transcription
 466 of *peID* and *div* constructs with intact and inactivated *div* promoter carried out under the same conditions as
 467 in Fig 4a. *peID* and *div* expression was measured in real-time for 48 hours, like as in Fig 4a. Because *peID*
 468 and *div* are not expressed at the same time (see Fig 4a), the maximum expression of both promoters is
 469 taken for this graph, which means early log for *div* and late log for *peID*. c) *In vitro* transcription of *peID* and
 470 *div* constructs with intact and inactivated *div* promoter in the presence of 100 nM CRP, 40 nM RNA
 471 polymerase and varying concentrations of FIS.

472

473 Using both these constructs we compared the *peID* mRNA levels produced in wild
 474 type and *fis* mutant cells. We observed that inactivation of *div* decreased *peID* transcription

475 in both the *D. dadantii* wild type and *fis* mutant cells (Fig 7b), indicating that *div* exerts an
476 activating effect on *peID* transcription and that activation is largely independent of FIS (this
477 effect was slightly more pronounced in wild type cells showing an 1.56-fold increase in
478 *peID* expression in presence of an intact *div* in WT cells, and an 1.41-fold in the *fis* cells).

479 Using both these constructs we also performed *in vitro* transcription experiments
480 (Fig 7c). With the construct carrying inactivated *div* we observed a 2-fold decrease of *peID*
481 transcription compared to that with intact *div*, confirming in a purified system that *div*
482 activates *peID*.

483

484 **DISCUSSION**

485

486 The purpose of this work was to provide an integrated picture of the temporal
487 regulation of the *peID* promoter driving the expression of a major virulence factor of the
488 plant pathogen *D. dadantii*. Upstream of the *peID* promoter we identified a divergent
489 promoter (*div*) which is not associated with any meaningful ORF and the activity of which
490 is strongly reduced by DNA relaxation *in vivo*. This sensitivity to supercoiling is consistent
491 with maximum *div* activity during early exponential phase, when the DNA superhelical
492 density is maximal, and its sharp reduction during transition of cells to stationary phase
493 and associated DNA relaxation [43]. In contrast, the *peID* promoter is activated on
494 transition to stationary phase concomitantly with the decline of *div* promoter activity. We
495 found that the relationship between the closely spaced *div* and *peID* promoters is not
496 trivial, as under conditions supporting high rates of transcription *in vitro*, the *div* promoter
497 binds RNAP and forms open complexes much more efficiently than *peID* and could thus
498 potentially compete with the latter (Fig 6a). However, inactivation of the *div* promoter

499 significantly decreases *peID* promoter activity (Fig 7bc). Furthermore, despite the facile
500 formation of open complexes by RNAP, the *div* promoter is considerably less active than
501 *peID in vivo* (Fig 4a) and is barely transcribed *in vitro* (Fig 6b). The reason for this
502 discrepancy is not entirely clear, but the structural organisation of *div* strongly resembles
503 that of a divergent promoter identified in the upstream region of the *E. coli fis* operon [45].
504 Both these weakly transcribed promoters demonstrate similar intrinsic properties such as
505 overly strong untwisting in conjunction with reasonably close-to-consensus -35 hexamer
506 sequences (TTGCAT for the *fis* divergent promoter, TTGAAT for the *peID* divergent
507 promoter).

508 In addition to studying the effects of two previously described CRP binding sites on
509 *peID* and *div*, we identified four FIS binding sites, two of which (FIS2/3) overlap the *peID*
510 promoter sequence, and two are located upstream (FIS1/1bis) and overlap with the *div*
511 promoter. The FIS2 and FIS3 sites act as repressor sites inhibiting the *peID* expression
512 during exponential growth phase (Fig 4a), whereas the FIS1 and FIS1bis sites, although
513 weak, can repress *div* transcription during early exponential growth *in vivo*, when the FIS
514 concentration is high (Fig 4a). However, it is noteworthy that inactivation of FIS1bis site
515 affected *peID* activity only *in vivo* (compare pPD4 and pPD5 in Fig 2) but not *in vitro*
516 (compare pJD3 and pJD9 in Fig S3). This could be attributed to differences in the *in vitro*
517 and *in vivo* conditions and indicate more complex relationships, perhaps involving changes
518 of other regulators not known at this time.

519 Repression of *peID* by FIS appears to be mediated by two mechanisms. The FIS2
520 site is the main repressor site preventing the binding of both the RNA polymerase and the
521 activator CRP at CRP2 site, whereas FIS3 site prevents the binding of RNA polymerase,
522 but does not interfere with CRP binding. The second CRP binding site (CRP1) is suitably

523 positioned to activate both the *div* and *pelD* promoters by providing interaction surfaces for
524 the C-terminal domains of the α subunits (α -CTDs) of RNAP [46]. Indeed, our data suggest
525 that binding of CRP at CRP1 and CRP2 synergistically activate both the *pelD* and *div*
526 promoters. However, the relative contribution of these two sites to the activity of the *pelD*
527 and *div* promoters is different. The pertinent question is whether the identified organisation
528 of the DNA binding sites and the observed relationships between the binding molecules of
529 RNAP and global regulators can be rationalised with regard to the critical function of *pelD*
530 gene in bacterial virulence.

531 532 **Mechanism of growth phase dependent regulation of *pelD***

533 For *D. dadantii* it is vital to completely repress the expression of *pelD* (as well as
534 other *pel* genes) in exponential phase, especially since any leaky *pel* expression would
535 trigger a massive production of Pels due to the KdgR positive feedback loop [17]. If the
536 bacterial population density is low, an early activation of *pel* genes results in an early
537 activation of the plant defense reactions and ultimately in bacterial death [47] as observed,
538 for example, in *D.dadantii* mutant lacking the *fis* gene [22]. This justifies an establishment
539 of redundant mechanisms for efficient *pelD* repression during exponential growth.

540 Our data suggest that *D. dadantii* uses three different mechanisms to prevent
541 aberrant expression of *pelD* during exponential growth phase: i) direct hindrance of the
542 RNA polymerase binding *via* FIS2 and FIS3, ii) competition between FIS and activator
543 CRP for binding of the overlapping FIS2 and the CRP2 sites and, iii) potential competition
544 of the *div* promoter with *pelD* promoter for RNA polymerase binding. Our observations
545 allow us to propose a model for regulation of the expression of *pelD* by taking into account
546 all these factors and the expression patterns of FIS (10) and the *div* promoter (Fig 8). CRP
547 is obviously central for this regulation, as it is absolutely required for the activity of both the

548 *peID* and *div* promoters. The DNA region with two CRP binding sites organised at optimal
549 positions for activating two divergent (*peID* and *div*) promoters would serve as a trap for
550 RNA polymerase directing transcription in one or another direction depending on the
551 transcriptional environment. The expression peak of the *div* promoter in *D. dadantii* is
552 observed at 6h during early exponential phase, i.e. when FIS is near its maximum
553 concentration (Fig 4a, lower panel). Given that FIS1/1bis are low affinity sites, high FIS
554 concentrations perhaps weakly interfere with binding of RNAP to *div* but fully repress *peID*
555 via FIS2/3. In addition, in early exponential phase the DNA is highly supercoiled (9),
556 allowing maximal *div* promoter activity mainly supported by CRP binding at CRP1 site
557 centred at -60.5 with respect to the *div* transcription initiation site. Indeed, whereas FIS
558 precludes the binding of CRP at CRP2 site and activation of *peID*, it does not interfere with
559 binding of CRP at CRP1 site and activation of *div*, consistent with different impact of
560 individual CRP binding sites on the *peID* and *div* promoter activity (Fig. 5b). At this growth
561 stage the high-affinity *div* promoter can serve as an efficient trap withdrawing the RNA
562 polymerase molecules that could otherwise bind at the *peID* promoter. During mid-
563 exponential phase the concentration of FIS is still sufficient to repress the *peID* promoter
564 via high affinity FIS2/3sites, but on transition to stationary phase (12h), the FIS
565 concentration subsides (see Fig 4a, lower panel) enabling transcription of *peID*. Our data
566 suggest that the burst of *peID* expression on transition of cells to stationary phase is likely
567 facilitated by two additional mechanisms. First, the reduced transcription of *div* (e.g. due to
568 the global relaxation of DNA), would abolish competition with *peID*. Second, due to the
569 increased cAMP levels at this stage [43], the cooperative binding of cAMP-CRP to CRP1
570 and CRP2 activator sites [26] would stabilise RNAP binding at *peID* leading to its maximal
571 expression. We propose that growth phase dependent competition between FIS and CRP

572 binding in conjunction with alterations of DNA topology provide an efficient temporal
 573 mechanism enabling both tight repression and strong activation of the *peID* promoter. It is
 574 likely that binding and bending of the DNA by CRP [48] at the CRP1 and CRP2 sites
 575 generally facilitates the recruitment of the RNAP molecules, whereas the changing pattern
 576 of CRP site occupation (binding of CRP at CRP1 initially, and then at both CRP1 and
 577 CRP2), determines the distribution of polymerase between *div* and *peID*. This mechanism
 578 implies that inactivation of the *div* promoter, despite its potential to compete with the *peID*
 579 promoter for RNAP binding, could lead to decreased *peID* activity.

580

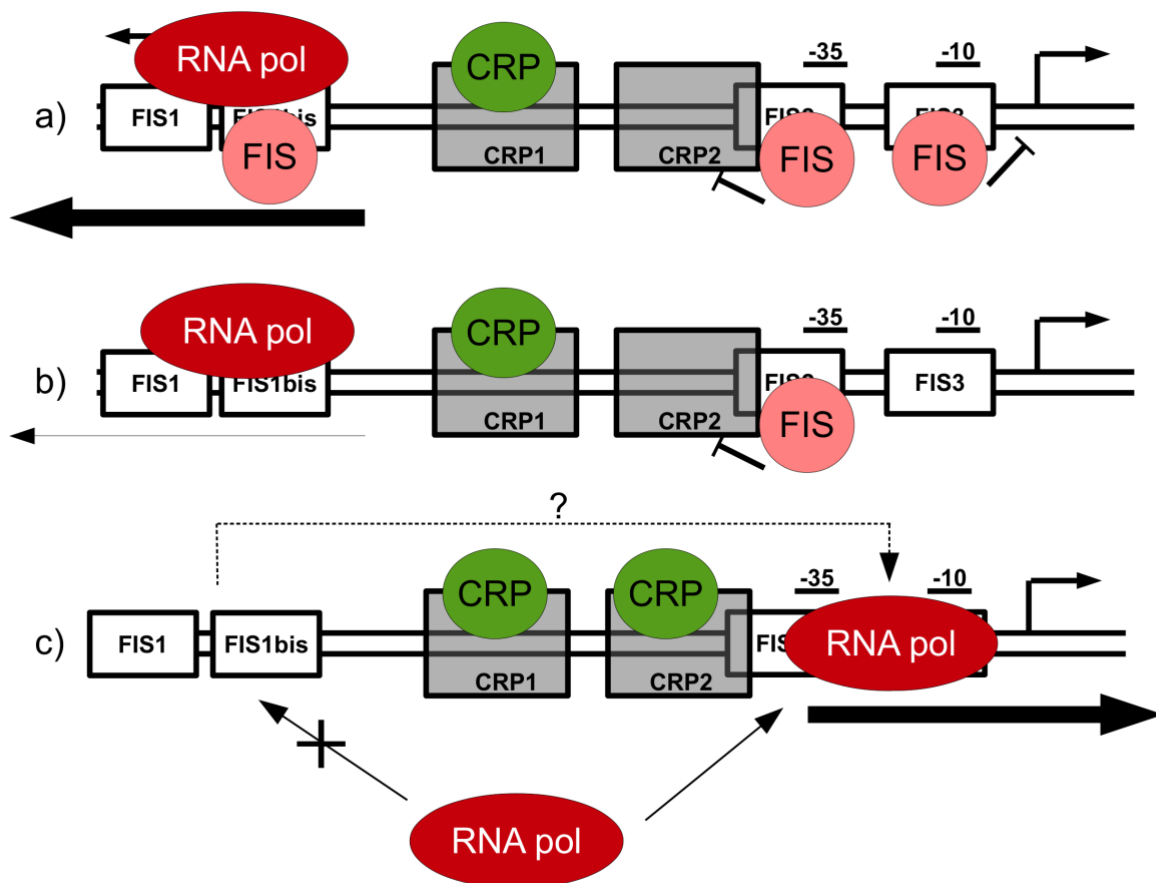

581

582 **Fig 8: Proposed model for the temporal control of *peID* by FIS, CRP and the divergent promoter.** For
 583 clarity, the *peID* regulatory region is represented in a linear fashion. Binding sites are represented by boxes
 584 (white for FIS, grey for CRP). Proteins are represented by ellipses: red for RNA polymerase, green for CRP,

585 pink for FIS. Large horizontal arrows indicate transcription. Lines ending with a bar indicate inhibition. a)
586 During early exponential phase, FIS sequentially occupies most of its binding sites and both the *peID* and *div*
587 promoters are repressed, albeit to different extent, since at this stage *div* is activated by high negative
588 superhelicity. The *div* promoter efficiently binds RNA polymerase due to its high affinity for RNAP and the low
589 affinity of the competitor FIS to the FIS1 and FIS1bis sites. Binding of CRP at CRP1 site also favours binding
590 of polymerase at *div* and so, the RNAP is “parking” at *div*. b) During the late exponential phase, DNA
591 relaxation inactivates *div* and presumably destabilises the binding of RNAP. At this stage, *peID* is still
592 repressed due to the overlapping high-affinity FIS sites. c) During transition to stationary phase FIS levels
593 subside and *peID* is de-repressed. RNA polymerase now preferentially binds *peID*. The activating effect of
594 *div* on *peID* at this stage is most likely due to a transfer of idling RNAP molecules previously “parking” at *div*
595 towards *peID*. This results in very strong transcription of *peID*.

596

597 **Biological implications**

598 Our data strongly suggest that the growth phase dependent regulation of *peID* is
599 under the control of changing composition of higher-order nucleoprotein complexes formed
600 in the *peID* regulatory region during the growth cycle. Such “alteration” of the composition
601 of regulatory nucleoprotein complexes during the growth cycle [49] seems to be a common
602 design principle employed for the growth phase-dependent gene regulation. Similar
603 regulatory mechanisms can be found not only at different promoters in single species but
604 also in different species, whereby involvement of several FIS binding sites in promoter
605 repression is not unusual. A well-known example is the negative autoregulation of the *fis*
606 promoter involving numerous FIS binding sites [50], and there are other examples, such as
607 the *mom* [36] and the *gyr* promoters of *E. coli* [6] and *Salmonella* [51], to name just a few.
608 However, multiple FIS binding sites can also be used to exert either an activating or
609 repressing effect [52].

610 On the other hand, there are only a few reports of a direct competition of FIS with

611 an activator [53,54]. The case of the *crp2* promoter is particularly relevant [54] as it shares
612 many similarities with the *pefD* promoter such as two high-affinity FIS binding sites
613 overlapping the -10 and -35 elements, whereby the FIS site overlapping the -35 element
614 also competes with binding of the activator CRP. Moreover, the *crp* regulatory region
615 harbours also a FIS-regulated divergent promoter competing with the *crp1* promoter, as
616 well as an upstream CRP binding site, which is little affected by FIS. Yet, there is no
617 sequence homology between the *D. dadantii pefD* and *E. coli crp* promoters, suggesting a
618 convergent evolution towards similar structural organisation of gene regulatory regions.

619 Also the *E. coli fis* promoter is subject to complex regulation involving FIS, CRP and a
620 supercoiling-dependent divergent promoter [45]. In this latter case the RNAP molecule
621 binding an upstream divergent site appears to directly interact with the RNAP bound at the
622 *fis* promoter and this interaction is implicated in sensing the changing DNA superhelicity
623 during the growth cycle. Similarly, in the *pefD* regulatory region it is the *div* promoter which
624 strongly depends on supercoiling and thus may serve as a sensor of DNA superhelicity
625 transmitting its changes to the *pefD* promoter. Whether the two RNAP molecules binding in
626 the *pefD* regulatory region can interact, is an open question that merits further
627 investigation. Theoretically, the 155 bp separation between the *div* and *pefD* transcription
628 start sites (given that RNAP footprints are typically 70 bp long) could suffice to avoid steric
629 hindrance between the RNAP molecules, but assuming that polymerase on average wraps
630 about 90 bp of on binding the promoter DNA [55,56] there could be competition, as is for
631 example, in the case of the *crp* promoter ([54,57] and Fig S6). It is noteworthy that also in
632 the *crp* regulatory region, only one of the promoters (*crp2*) appears to be strongly sensitive
633 to supercoiling, suggesting that the topological state of the DNA is one major variable
634 involved in modulating the growth phase-dependent impacts of regulatory nucleoprotein

635 complexes assembled on divergent promoter modules [54,57].

636 We infer that the organisation of *peID* promoter region reveals a strategic design of
637 protein binding sites evolved for reconciliation of strong expression with regulatability. The
638 *peID* gene is one among the many bacterial virulence genes known to be under the control
639 of several TFs and be also tightly environmentally regulated [58]. Indeed, it is not
640 uncommon to see more than five different TFs acting on a single virulence gene
641 [16,59,60]. By taking into account the binding of CRP, FIS and RNA polymerase at
642 multiple sites in *peID*, as well as many regulators unconsidered in this study, such as H-NS
643 and PecT, which are key components in the thermoregulation of the *peI* genes [61], or
644 PecS, which is known to interact with CRP [26], a highly dynamic regulatory mechanism
645 has to be envisioned. Comprehensive understanding of the strategic design underlying the
646 spatial organisation of regulatory binding sites in *peID* and the topological constraints
647 imposed on the cooperative and antagonistic interactions between various TFs remains an
648 important focus for further studies.

649

650

651 **FUNDING INFORMATION**

652 This work was supported by the Centre National de la Recherche Scientifique; Université
653 de Lyon; and Institut National des Sciences Appliquées [BQR 2013 « Topologie de l'ADN
654 et organisation du nucléoïde » to S.R.]. The funders had no role in study design, data
655 collection and interpretation, or the decision to submit the work for publication.

656

657 **ACKNOWLEDGEMENT**

658 The authors would like to thank the teams of Agnès Rodrigue and Xavier Charpentier for

659 providing access to their Tecan plate reader. We are grateful to Julien Wawrzyniak for the
660 purification of FIS and CRP proteins and Xuejiao Jiang for her assistance with RNAseq
661 data analysis that first allowed the detection of *div* transcription.

662

663 REFERENCES

- 664 [1] D.F. Browning, S.J.W. Busby, The regulation of bacterial transcription initiation, *Nat. Rev. Microbiol.* 2 (2004)
665 57–65. doi:10.1038/nrmicro787.
- 666 [2] A. Bhat, M. Shin, J.-H. Jeong, H.-J. Kim, H.-J. Lim, J.H. Rhee, S.-Y. Paik, K. Takeyasu, T. Tobe, H. Yen, G.
667 Lee, H.E. Choy, DNA looping-dependent autorepression of LEE1 P1 promoters by Ler in enteropathogenic
668 *Escherichia coli* (EPEC), *Proc. Natl. Acad. Sci. U. S. A.* 111 (2014) E2586–E2595.
669 doi:10.1073/pnas.1322033111.
- 670 [3] Z.-A. Ouafa, S. Reverchon, T. Lautier, G. Muskhelishvili, W. Nasser, The nucleoid-associated proteins H-NS and
671 FIS modulate the DNA supercoiling response of the *pel* genes, the major virulence factors in the plant pathogen
672 bacterium *Dickeya dadantii*, *Nucleic Acids Res.* 40 (2012) 4306–4319. doi:10.1093/nar/gks014.
- 673 [4] D. Skoko, D. Yoo, H. Bai, B. Schnurr, J. Yan, S.M. McLeod, J.F. Marko, R.C. Johnson, Mechanism of
674 chromosome compaction and looping by the *E. coli* nucleoid protein Fis, *J. Mol. Biol.* 364 (2006) 777–798.
675 doi:10.1016/j.jmb.2006.09.043.
- 676 [5] S.C. Dillon, C.J. Dorman, Bacterial nucleoid-associated proteins, nucleoid structure and gene expression, *Nat.*
677 *Rev. Microbiol.* 8 (2010) 185–195. doi:10.1038/nrmicro2261.
- 678 [6] R. Schneider, A. Travers, T. Kutateladze, G. Muskhelishvili, A DNA architectural protein couples cellular
679 physiology and DNA topology in *Escherichia coli*, *Mol. Microbiol.* 34 (1999) 953–964. doi:10.1046/j.1365-
680 2958.1999.01656.x.
- 681 [7] D.J. Jin, C. Cagliero, Y.N. Zhou, Role of RNA Polymerase and Transcription in the Organization of the Bacterial
682 Nucleoid, *Chem. Rev.* (2013) 130813134324001. doi:10.1021/cr4001429.
- 683 [8] A. Travers, G. Muskhelishvili, Bacterial chromatin, *Curr. Opin. Genet. Dev.* 15 (2005) 507–514.
684 doi:10.1016/j.gde.2005.08.006.
- 685 [9] R. Schneider, A. Travers, G. Muskhelishvili, FIS modulates growth phase-dependent topological transitions of
686 DNA in *Escherichia coli*, *Mol. Microbiol.* 26 (1997) 519–530.
- 687 [10] T. Ali Azam, A. Iwata, A. Nishimura, S. Ueda, A. Ishihama, Growth Phase-Dependent Variation in Protein
688 Composition of the *Escherichia coli* Nucleoid, *J. Bacteriol.* 181 (1999) 6361–6370.
- 689 [11] D.F. Browning, D.C. Grainger, S.J. Busby, Effects of nucleoid-associated proteins on bacterial chromosome
690 structure and gene expression, *Curr. Opin. Microbiol.* 13 (2010) 773–780. doi:10.1016/j.mib.2010.09.013.
- 691 [12] A. Duprey, S. Reverchon, W. Nasser, Bacterial virulence and Fis: adapting regulatory networks to the host
692 environment, *Trends Microbiol.* 22 (2014) 92–99. doi:10.1016/j.tim.2013.11.008.
- 693 [13] B. Ma, M.E. Hibbing, H.-S. Kim, R.M. Reedy, I. Yedidia, J. Breuer, J. Breuer, J.D. Glasner, N.T. Perna, A.
694 Kelman, A.O. Charkowski, Host Range and Molecular Phylogenies of the Soft Rot Enterobacterial Genera
695 *Pectobacterium* and *Dickeya*, *Phytopathology.* 97 (2007) 1150–1163. doi:10.1094/PHYTO-97-9-1150.
- 696 [14] S. Hassan, V.E. Shevchik, X. Robert, N. Hugouvieux-Cotte-Pattat, PelN Is a New Pectate Lyase of *Dickeya*
697 *dadantii* with Unusual Characteristics, *J. Bacteriol.* 195 (2013) 2197–2206. doi:10.1128/JB.02118-12.
- 698 [15] F. Tardy, W. Nasser, J. Robert-Baudouy, N. Hugouvieux-Cotte-Pattat, Comparative analysis of the five major
699 *Erwinia chrysanthemi* pectate lyases: enzyme characteristics and potential inhibitors., *J. Bacteriol.* 179 (1997)
700 2503–2511.
- 701 [16] S. Reverchon, W. Nasser, *Dickeya* ecology, environment sensing and regulation of virulence programme:
702 *Dickeya dadantii* pathogenicity, *Environ. Microbiol. Rep.* (2013) n/a-n/a. doi:10.1111/1758-2229.12073.
- 703 [17] S. Reverchon, W. Nasser, J. Robert-Baudouy, Characterization of *kdgR*, a gene of *Erwinia chrysanthemi* that
704 regulates pectin degradation, *Mol. Microbiol.* 5 (1991) 2203–2216.
- 705 [18] W. Nasser, S. Reverchon, G. Condemine, J. Robert-Baudouy, Specific Interactions of *Erwinia chrysanthemi*
706 *KdgR* Repressor with Different Operators of Genes Involved in Pectinolysis, *J. Mol. Biol.* 236 (1994) 427–440.
707 doi:10.1006/jmbi.1994.1155.
- 708 [19] W. Nasser, J. Robert-Baudouy, S. Reverchon, Antagonistic effect of CRP and *KdgR* in the transcription control

- 709 of the *Erwinia chrysanthemi* pectinolysis genes, *Mol. Microbiol.* 26 (1997) 1071–1082. doi:10.1046/j.1365-
710 2958.1997.6472020.x.
- 711 [20] S. Reverchon, F. Van Gijsegem, G. Effantin, O. Zghidi-Abouzid, W. Nasser, Systematic targeted mutagenesis of
712 the MarR/SlyA family members of *Dickeya dadantii* 3937 reveals a role for MfbR in the modulation of virulence
713 gene expression in response to acidic pH, *Mol. Microbiol.* 78 (2010) 1018–1037. doi:10.1111/j.1365-
714 2958.2010.07388.x.
- 715 [21] S. Reverchon, D. Expert, J. Robert-Baudouy, W. Nasser, The cyclic AMP receptor protein is the main activator
716 of pectinolysis genes in *Erwinia chrysanthemi*, *J. Bacteriol.* 179 (1997) 3500–3508.
- 717 [22] T. Lautier, W. Nasser, The DNA nucleoid-associated protein Fis co-ordinates the expression of the main
718 virulence genes in the phytopathogenic bacterium *Erwinia chrysanthemi*, *Mol. Microbiol.* 66 (2007) 1474–1490.
719 doi:10.1111/j.1365-2958.2007.06012.x.
- 720 [23] C. Beaulieu, M. Boccara, F. Van Gijsegem, Pathogenic Behavior of Pectinase-Defective *Erwinia chrysanthemi*
721 Mutants on Different Plants, *Mol. Plant. Microbe Interact.* 6 (1993) 197. doi:10.1094/MPMI-6-197.
- 722 [24] M. Boccara, A. Diolez, M. Rouve, A. Kotoujansky, The role of individual pectate lyases of *Erwinia chrysanthemi*
723 strain 3937 in pathogenicity on saintpaulia plants, *Physiol. Mol. Plant Pathol.* 33 (1988) 95–104.
724 doi:10.1016/0885-5765(88)90046-X.
- 725 [25] T. Lautier, N. Blot, G. Muskhelishvili, W. Nasser, Integration of two essential virulence modulating signals at the
726 *Erwinia chrysanthemi* pel gene promoters: a role for Fis in the growth-phase regulation, *Mol. Microbiol.* 66
727 (2007) 1491–1505. doi:10.1111/j.1365-2958.2007.06010.x.
- 728 [26] C. Rouanet, K. Nomura, S. Tsuyumu, W. Nasser, Regulation of pelD and pelE, Encoding Major Alkaline Pectate
729 Lyases in *Erwinia chrysanthemi*: Involvement of the Main Transcriptional Factors, *J. Bacteriol.* 181 (1999)
730 5948–5957.
- 731 [27] Miller JH, *Experiment in Molecular Genetics*, Cold Spring Harbor Laboratory Press, 1972.
- 732 [28] A. Duprey, V. Chansavang, F. Fremion, C. Gonther, Y. Louis, P. Lejeune, F. Springer, V. Desjardin, A.
733 Rodrigue, C. Dorel, “NiCo Buster”: engineering *E. coli* for fast and efficient capture of cobalt and nickel, *J. Biol.*
734 *Eng.* 8 (2014) 19. doi:10.1186/1754-1611-8-19.
- 735 [29] C. Marschall, V. Labrousse, M. Kreimer, D. Weichart, A. Kolb, R. Hengge-Aronis, Molecular analysis of the
736 regulation of *csiD*, a carbon starvation-inducible gene in *Escherichia coli* that is exclusively dependent on σ^S and
737 requires activation by cAMP-CRP, *J. Mol. Biol.* 276 (1998) 339–353. doi:10.1006/jmbi.1997.1533.
- 738 [30] J. Sambrook, D.W. Russell, *Molecular cloning : a laboratory manual*, 3rd ed., Cold Spring Harbor Laboratory
739 Press, 2001.
- 740 [31] H. De Jong, C. Ranquet, D. Ropers, C. Pinel, J. Geiselmann, Experimental and computational validation of
741 models of fluorescent and luminescent reporter genes in bacteria, *BMC Syst. Biol.* 4 (2010) 55.
- 742 [32] V.V. Verkhusha, I.M. Kuznetsova, O.V. Stepanenko, A.G. Zaraisky, M.M. Shavlovsky, K.K. Turoverov, V.N.
743 Uversky, High Stability of Discosoma DsRed As Compared to Aequorea EGFP†, *Biochemistry (Mosc.)*. 42
744 (2003) 7879–7884. doi:10.1021/bi034555t.
- 745 [33] N. Bardonnnet, A. Trautwetter, G. Couchoux-Luthaud, C. Blanco, Plasmids with the *uidA* reporter gene for the
746 detection of promoters and transcription signals, *Mol. Gen. Genet. MGG.* 212 (1988) 390–392.
- 747 [34] A. Hatoum, J. Roberts, Prevalence of RNA polymerase stalling at *Escherichia coli* promoters after open complex
748 formation, *Mol. Microbiol.* 68 (2008) 17–28. doi:10.1111/j.1365-2958.2008.06138.x.
- 749 [35] R. Münch, K. Hiller, A. Grote, M. Scheer, J. Klein, M. Schobert, D. Jahn, Virtual Footprint and PRODORIC: an
750 integrative framework for regulon prediction in prokaryotes, *Bioinformatics.* 21 (2005) 4187–4189.
751 doi:10.1093/bioinformatics/bti635.
- 752 [36] S. Karambelkar, G. Swapna, V. Nagaraja, Silencing of toxic gene expression by Fis, *Nucleic Acids Res.* 40
753 (2012) 4358–4367. doi:10.1093/nar/gks037.
- 754 [37] W. Nasser, C. Dorel, J. Wawrzyniak, F. Van Gijsegem, M.-C. Groleau, E. Déziel, S. Reverchon, Vfm a new
755 quorum sensing system controls the virulence of *Dickeya dadantii*, *Environ. Microbiol.* 15 (2013) 865–880.
756 doi:10.1111/1462-2920.12049.
- 757 [38] V. James, N. Hugouvieux-Cotte-Pattat, Regulatory systems modulating the transcription of the pectinase genes of
758 *Erwinia chrysanthemi* are conserved in *Escherichia coli*, *Microbiol. Read. Engl.* 142 (Pt 9) (1996) 2613–2619.
- 759 [39] H.S. Kim, Cloning and Expression of β -Glucuronidase from *Lactobacillus brevis* in *E. coli* and Application in
760 Bioconversion of Baicalin and Wogonoside, *J. Microbiol. Biotechnol.* 19 (2009) 1650–1655.
761 doi:10.4014/jmb.0904.04053.
- 762 [40] J. Eriksson, T. Nordström, P. Nyrén, Method enabling firefly luciferase-based bioluminometric assays at elevated
763 temperatures, *Anal. Biochem.* 314 (2003) 158–161. doi:10.1016/S0003-2697(02)00647-4.
- 764 [41] W.D. Kepseu, J.-A. Sepulchre, S. Reverchon, W. Nasser, Toward a quantitative modeling of the synthesis of the
765 pectate lyases, essential virulence factors in *Dickeya dadantii*, *J. Biol. Chem.* 285 (2010) 28565–28576.
766 doi:10.1074/jbc.M110.114710.

- 767 [42] A. Maxwell, DNA gyrase as a drug target, *Trends Microbiol.* 5 (1997) 102–109. doi:10.1016/S0966-
768 842X(96)10085-8.
- 769 [43] V.L. Balke, J.D. Gralla, Changes in the linking number of supercoiled DNA accompany growth transitions in
770 *Escherichia coli*, *J. Bacteriol.* 169 (1987) 4499–4506.
- 771 [44] F. Rojo, Mechanisms of transcriptional repression, *Curr. Opin. Microbiol.* 4 (2001) 145–151. doi:10.1016/S1369-
772 5274(00)00180-6.
- 773 [45] V. Gerganova, S. Maurer, L. Stoliar, A. Japaridze, G. Dietler, W. Nasser, T. Kutateladze, A. Travers, G.
774 Muskhelishvili, Upstream Binding of Idling RNA Polymerase Modulates Transcription Initiation from a Nearby
775 Promoter, *J. Biol. Chem.* (2015) jbc.M114.628131. doi:10.1074/jbc.M114.628131.
- 776 [46] S.M. McLeod, S.E. Aiyar, R.L. Gourse, R.C. Johnson, The C-terminal domains of the RNA polymerase α
777 subunits: contact site with fis and localization during co-activation with CRP at the *Escherichia coli* proP P2
778 promoter, *J. Mol. Biol.* 316 (2002) 517–529. doi:10.1006/jmbi.2001.5391.
- 779 [47] P.R. Davidsson, T. Kariola, O. Niemi, E.T. Palva, Pathogenicity of and plant immunity to soft rot pectobacteria,
780 *Front. Plant Sci.* 4 (2013). doi:10.3389/fpls.2013.00191.
- 781 [48] S.-H. Lin, J.C. Lee, Determinants of DNA Bending in the DNA–Cyclic AMP Receptor Protein Complexes in
782 *Escherichia coli*, *Biochemistry (Mosc.)*. 42 (2003) 4809–4818. doi:10.1021/bi027259+.
- 783 [49] W. Nasser, R. Schneider, A. Travers, G. Muskhelishvili, CRP Modulates fis Transcription by Alternate
784 Formation of Activating and Repressing Nucleoprotein Complexes, *J. Biol. Chem.* 276 (2001) 17878–17886.
785 doi:10.1074/jbc.M100632200.
- 786 [50] C.A. Ball, R. Osuna, K.C. Ferguson, R.C. Johnson, Dramatic changes in Fis levels upon nutrient upshift in
787 *Escherichia coli*, *J. Bacteriol.* 174 (1992) 8043–8056.
- 788 [51] O.M. Keane, C.J. Dorman, The gyr genes of *Salmonella enterica* serovar Typhimurium are repressed by the
789 factor for inversion stimulation, Fis, *Mol. Genet. Genomics.* 270 (2003) 56–65. doi:10.1007/s00438-003-0896-1.
- 790 [52] A. Chastanet, R. Losick, Just-in-Time Control of Spo0A Synthesis in *Bacillus subtilis* by Multiple Regulatory
791 Mechanisms ∇ , *J. Bacteriol.* 193 (2011) 6366–6374. doi:10.1128/JB.06057-11.
- 792 [53] D.J.P. Squire, M. Xu, J.A. Cole, S.J.W. Busby, D.F. Browning, Competition between NarL-dependent activation
793 and Fis-dependent repression controls expression from the *Escherichia coli* *yeaR* and *ogt* promoters, *Biochem. J.*
794 420 (2009) 249–257. doi:10.1042/BJ20090183.
- 795 [54] G. González-Gil, R. Kahmann, G. Muskhelishvili, Regulation of *crp* transcription by oscillation between distinct
796 nucleoprotein complexes, *EMBO J.* 17 (1998) 2877–2885.
- 797 [55] C. Rivetti, M. Guthold, C. Bustamante, Wrapping of DNA around the *E. coli* RNA polymerase open promoter
798 complex, *EMBO J.* 18 (1999) 4464–4475. doi:10.1093/emboj/18.16.4464.
- 799 [56] S. Maurer, J. Fritz, G. Muskhelishvili, A. Travers, RNA polymerase and an activator form discrete subcomplexes
800 in a transcription initiation complex, *EMBO J.* 25 (2006) 3784–3790. doi:10.1038/sj.emboj.7601261.
- 801 [57] A. Hanamura, H. Aiba, Molecular mechanism of negative autoregulation of *Escherichia coli* *crp* gene., *Nucleic*
802 *Acids Res.* 19 (1991) 4413–4419.
- 803 [58] J.S. Kroll, Bacterial virulence: an environmental response., *Arch. Dis. Child.* 66 (1991) 361–363.
- 804 [59] C. Altier, Genetic and environmental control of *Salmonella* invasion, *J. Microbiol.* 43 (2005) 85–92.
- 805 [60] T.L. Yahr, M.C. Wolfgang, Transcriptional regulation of the *Pseudomonas aeruginosa* type III secretion system,
806 *Mol. Microbiol.* 62 (2006) 631–640. doi:10.1111/j.1365-2958.2006.05412.x.
- 807 [61] E. Héroult, S. Reverchon, W. Nasser, Role of the LysR-type transcriptional regulator PecT and DNA supercoiling
808 in the thermoregulation of *pel* genes, the major virulence factors in *Dickeya dadantii*: *Dickeya dadantii* PecT
809 protein and virulence thermoregulation, *Environ. Microbiol.* 16 (2014) 734–745. doi:10.1111/1462-2920.12198.
- 810 [62] A. Kotoujansky, M. Lemattre, P. Boistard, Utilization of a thermosensitive episome bearing transposon TN10 to
811 isolate Hfr donor strains of *Erwinia carotovora* subsp. *chrysanthemii*, *J. Bacteriol.* 150 (1982) 122–131.
- 812 [63] G. González-Gil, P. Bringmann, R. Kahmann, FIS is a regulator of metabolism in *Escherichia coli*, *Mol.*
813 *Microbiol.* 22 (1996) 21–29. doi:10.1111/j.1365-2958.1996.tb02652.x.
- 814 [64] W.G. Miller, J.H. Leveau, S.E. Lindow, Improved *gfp* and *inaZ* broad-host-range promoter-probe vectors, *Mol.*
815 *Plant-Microbe Interact. MPMI.* 13 (2000) 1243–1250. doi:10.1094/MPMI.2000.13.11.1243.
- 816

817

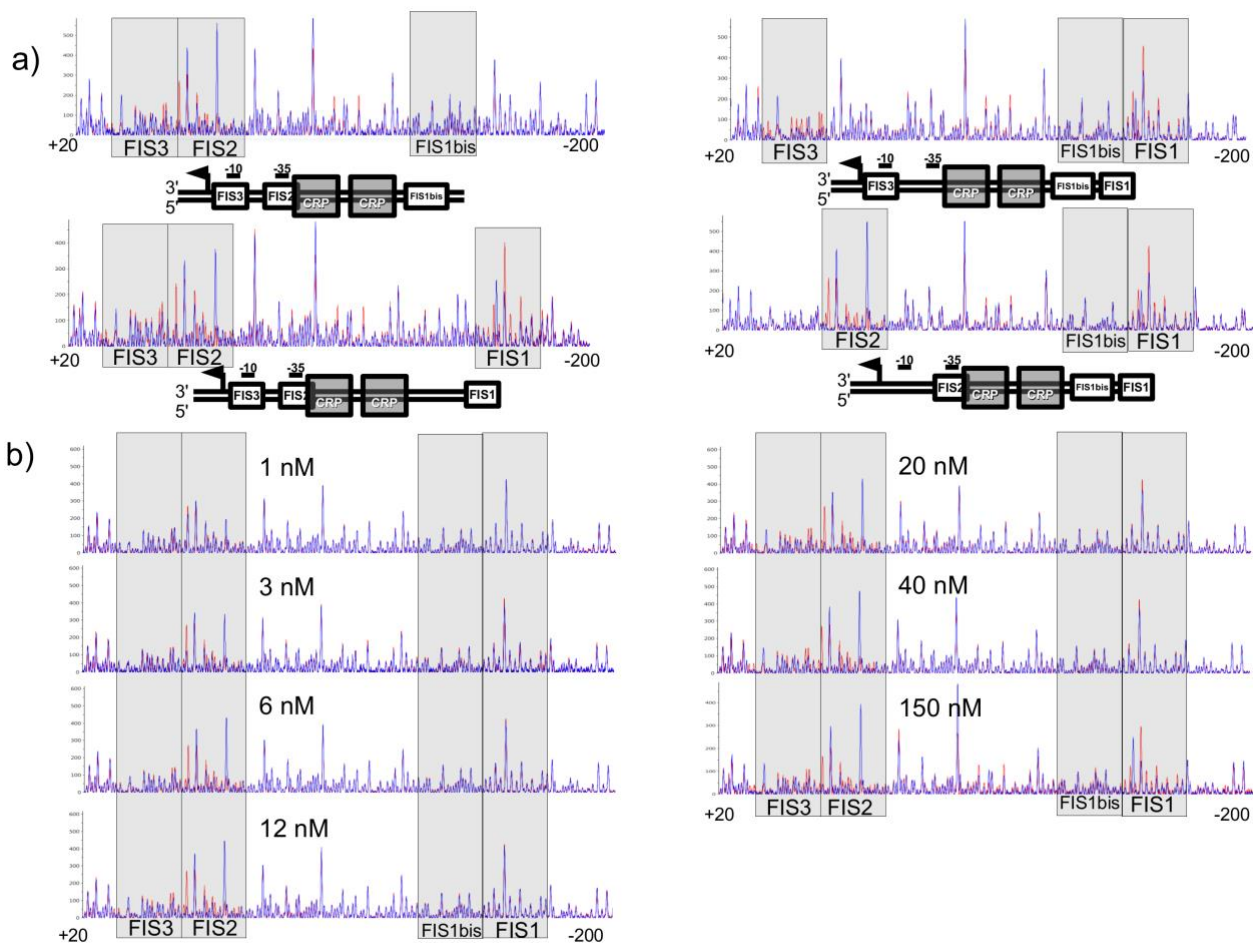

820

821 **Fig S1: DNase I footprinting of FIS binding in the *pelD* regulatory region.** DNase I footprinting was
 822 performed using fluorescently labelled linear *pelD* DNA. The profiles represent the pattern obtained for the
 823 template strand. The red and the blue profiles correspond respectively to the samples without and with FIS.
 824 a) Profiles for *pelD* DNA samples with inactivated FIS1, FIS1bis, FIS2 or FIS3 sites at 150 nM FIS
 825 concentration. b) Profiles of the wild type *pelD* DNA incubated with increasing concentrations of FIS (from 1
 826 to 150 nM)

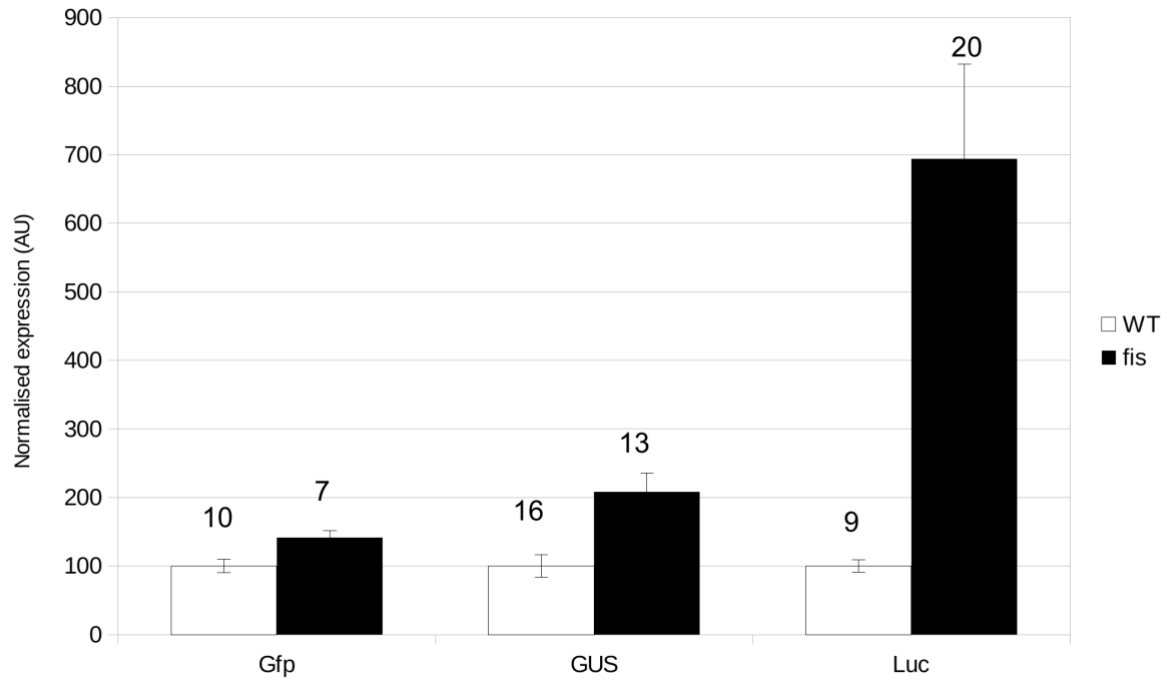

827

828 **Fig S2: Comparison between the Gfp and Luc reporter systems in *D. dadantii* and the GUS system in**
 829 ***E. coli*.** Bacteria transformed with the wild-type *peID* regulatory region in a reporter plasmid were cultured in
 830 equivalent conditions (see materials and methods). The normalised fluorescence and GUS specific activity
 831 were taken in early stationary phase and the luminescence at the maximum. Data represents the mean of 3
 832 (GUS) to 12 replicates (Gfp and Luc) and error bars represent the standard deviation. Numbers above the
 833 error bars indicate the coefficient of variation (in %).

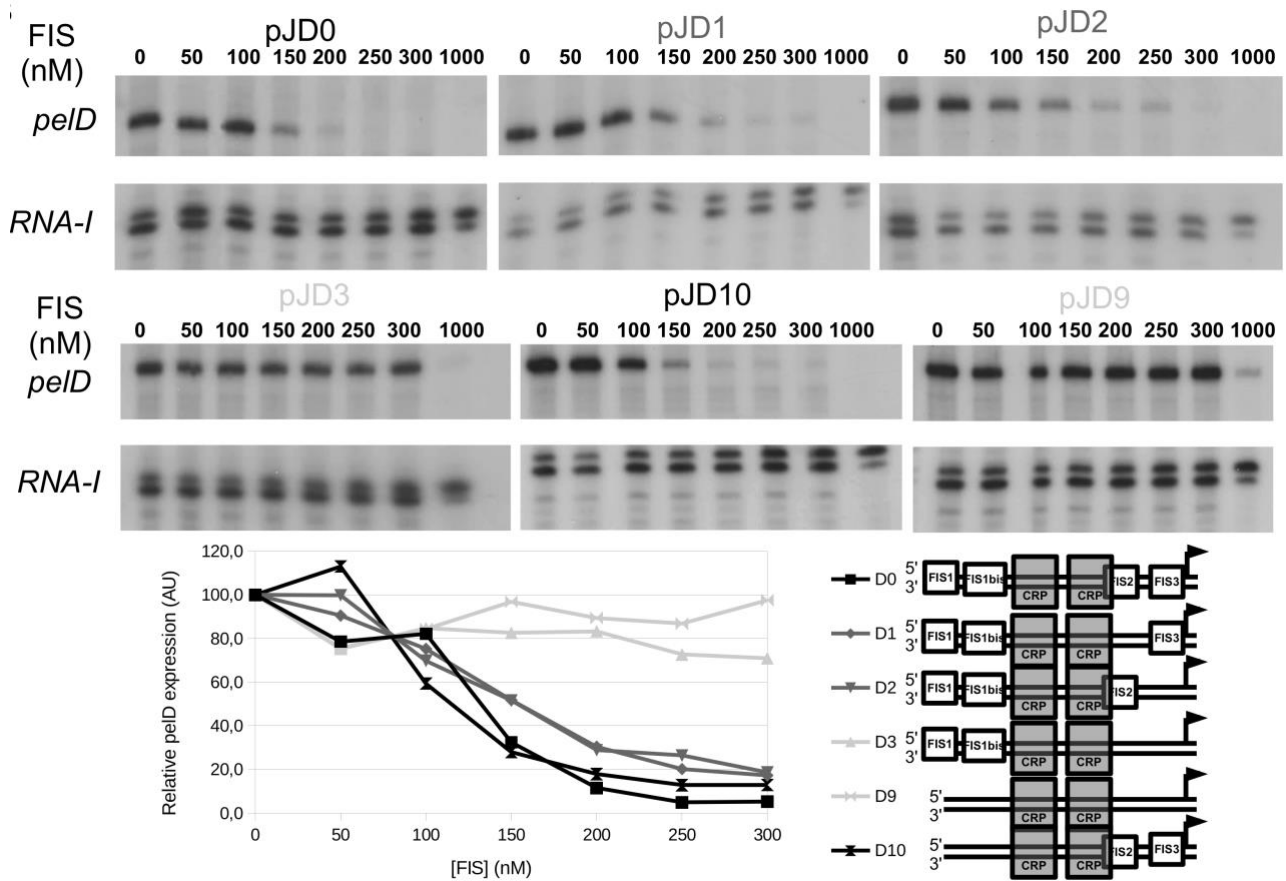

834

835 **Fig S3: Effect of FIS binding on *peiD* transcription *in vitro*.** *In vitro* transcription was performed using
 836 several *peiD* constructs (plasmids D0, D1, D2, D3, D9 and D10 indicated in the bottom left panel) in
 837 presence of 100 nM CRP, 40 nM RNA polymerase and varying concentrations of FIS. The RNA-I internal
 838 control was used as a standard for quantification of the *peiD* transcript (bottom right panel).

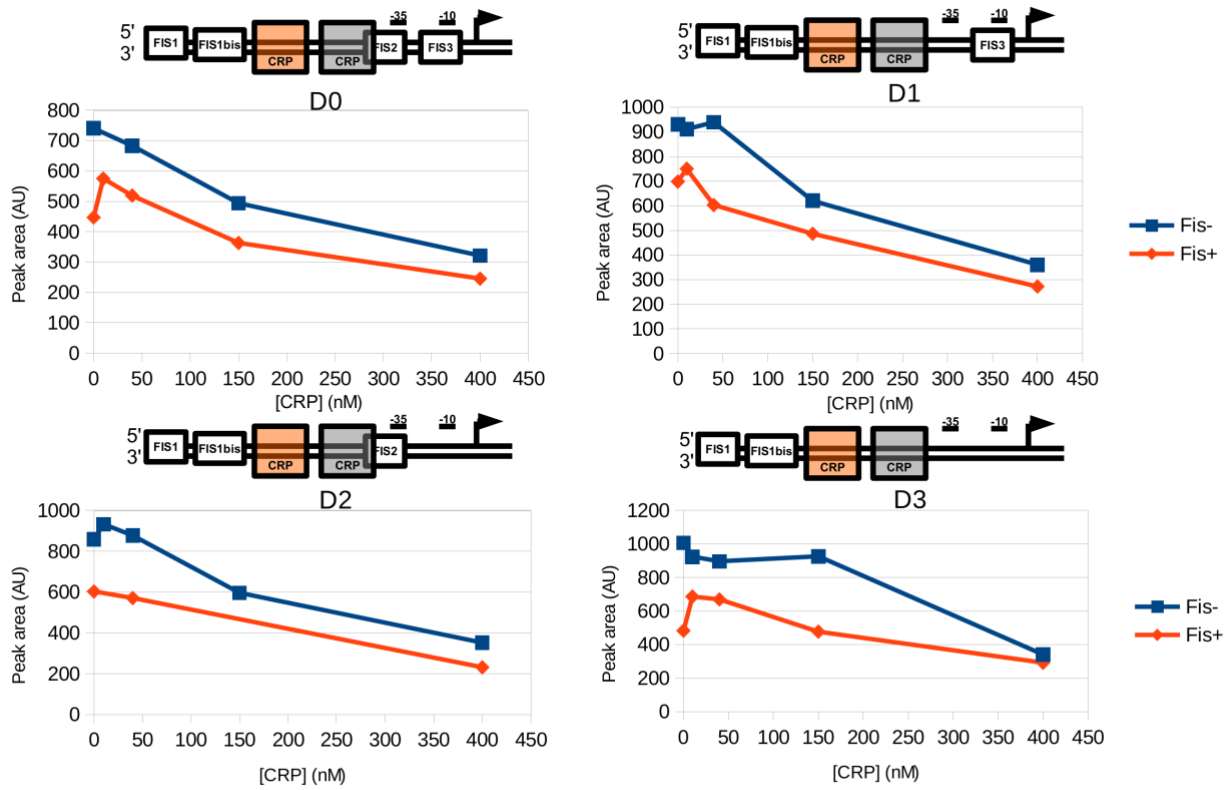

839

840 **Fig S4: Absence of modification of the CRP1 DNase I footprint by the presence of FIS.** A quantitative
 841 DNase I footprint was performed on fluorescently labelled *peID* regulatory regions, in identical conditions as
 842 in figure 5. The area of the peaks at one position inside CRP1 (at position -85 relatively to the transcription
 843 start site) for different CRP concentrations is represented.

844

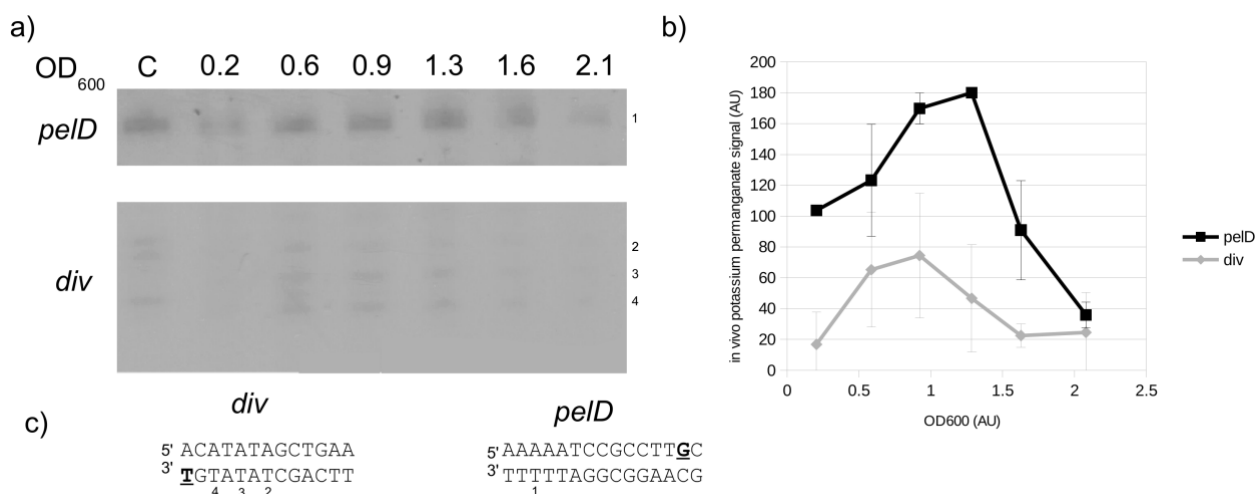

846

847 **Fig S5: *in vivo* potassium permanganate footprinting of the *pelD* regulatory region.** pKD0 (wild-type
 848 *pelD*) was transformed into *D. dadantii*. Bacteria were then cultured in M63S + PGA and an *in vivo*
 849 potassium permanganate footprinting was performed as described in materials and methods. (a) image of
 850 one replicate of the experiment. Lane C corresponds to an *in vitro* potassium permanganate footprinting
 851 control performed on the same plasmid with 100 nM CRP and 40 nM RNAP. Bands are numbered and
 852 localised in part c of the figure. (b) quantification of the intensity of the bands, represented as mean +/- SD of
 853 2 independent biological replicates. (c) Position of the attacked nucleotides of part a. Both strands are shown
 854 and transcription start sites are underlined.

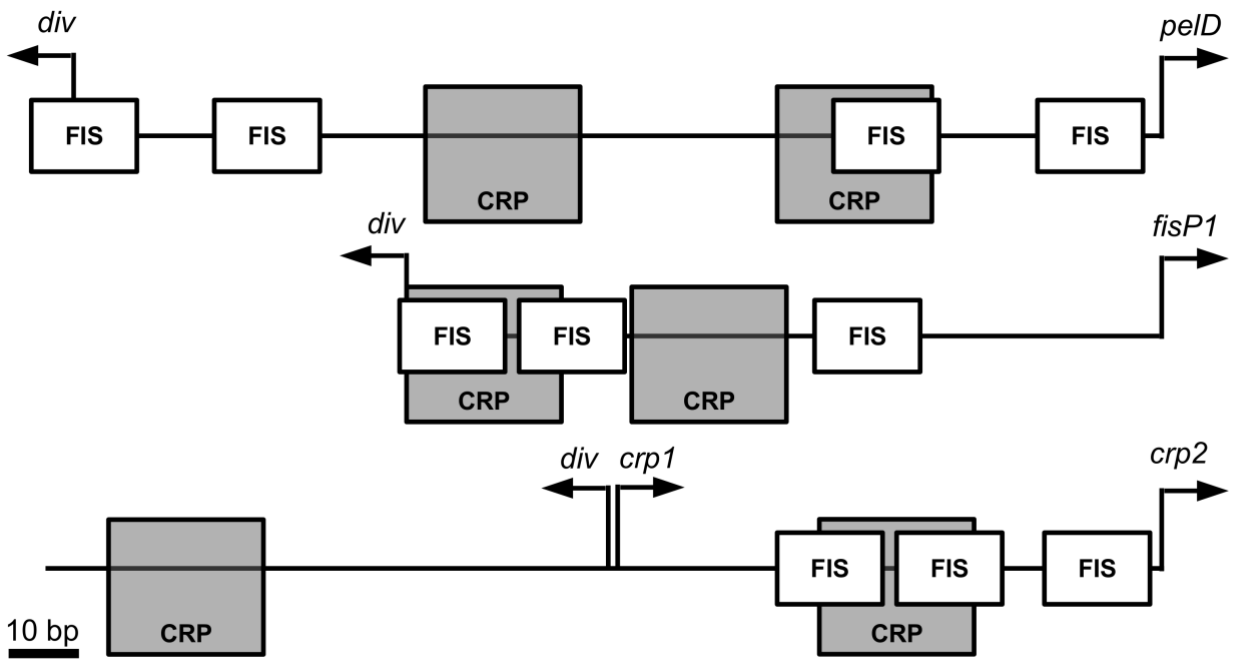

855

856 **Fig S6: Regulatory structure of 3 different relevant promoters regulated by a divergent promoter.** The
 857 *peID* (*D. dadantii*), *fis* (*E. coli*) and *crp* (*E. coli*) regulatory regions are represented. The known promoters are
 858 represented with an arrow, FIS sites by white boxes and CRP sites by gray boxes, as described in the
 859 literature and this work. The promoter which is coupled to *div* is drawn on the right. All regulatory regions
 860 and binding sites are represented to scale. The scale bar in the bottom left corner represents 10 base pairs.

861 **Table S1: strains, plasmids and oligos used in this study**

Strains	Description		Ref
<i>D. dadantii</i>			
3937 (A4922)	Wild-type strain isolated from <i>Saintpaulia ionantha</i>		[62]
A4474	3937 <i>fis</i> ::Cm ^R		[22]
<i>E. coli</i>			
CSH50	F- <i>araBAD-0 M(pro-lac) λ- rpsL-(strR) thi- fimE1::IS1-</i>		[27]
I3506	CSH50 <i>fis</i> ::Cm ^R		[63]
Plasmids	Description	Inactivated FIS sites	Ref
pNB4	Reporter vector with <i>uidA</i> , Amp ^R		[33]
pProbe-AT '	Reporter vector with <i>gfp</i> , Amp ^R		[64]

pBluescript SK+	Cloning vector, AmpR		Stratagene
pBluescript KS+	Cloning vector, AmpR		Stratagene
pUCter-Luc-Cm	Reporter vector with <i>luc</i> , AmpR CmR		(7)
pJV	<i>In vitro</i> transcription vector AmpR		This work
pWN2481 (pKD0)	pBluescript KS+ containing the wild-type <i>peID</i> regulatory region between sites EcoRI and HindIII	none	[26]
pKD1	pBluescript SK+ containing a mutated <i>peID</i> regulatory region at site SmaI (T7 promoter oriented)	2	This work
pKD2	pBluescript SK+ containing a mutated <i>peID</i> regulatory region at site SmaI (T7 promoter oriented)	3	This work
pKD3	pBluescript SK+ containing a mutated <i>peID</i> regulatory region at site SmaI (T7 promoter oriented)	2,3	This work
pKD4	pBluescript SK+ containing a mutated <i>peID</i> regulatory region at site SmaI (T7 promoter oriented)	1, 2, 3	This work
pKD5	pBluescript SK+ containing a mutated <i>peID</i> regulatory region at site SmaI (T7 promoter oriented)	1bis, 2, 3	This work
pKD7	pBluescript KS+ containing a mutated <i>peID</i> regulatory region between sites EcoRI and HindIII	1bis	This work
pKD9	pBluescript SK+ containing a mutated <i>peID</i> regulatory region at site SmaI (T7 promoter oriented)	1, 1bis, 2, 3	This work
pKD10	pBluescript KS+ containing a mutated <i>peID</i> regulatory region between sites EcoRI and HindIII	1, 1bis	This work
pKD24	pBluescript KS+ containing a mutated <i>peID</i> regulatory region between sites EcoRI and HindIII, with <i>div</i> inactivated	none	This work
pKD26	pBluescript KS+ containing a mutated <i>peID</i> regulatory region between sites EcoRI and HindIII, with CRP2 inactivated	none	This work
pKD27	pBluescript KS+ containing a mutated <i>peID</i> regulatory region between sites EcoRI and HindIII, with CRP1 inactivated	none	This work
pKD28	pBluescript KS+ containing a mutated <i>peID</i> regulatory region between sites EcoRI and HindIII, with CRP1 and CRP2 inactivated	none	This work
pND0	pNB4 containing the wild-type <i>peID</i> regulatory region between sites EcoRI and HindIII	none	This work
pLD0	pUCter-Luc-Cm containing the wild-type <i>peID</i> regulatory region between sites NheI and XhoI	none	This work
pPD0	pProbe-AT ' containing the wild-type <i>peID</i> regulatory region between sites EcoRI and HindIII	none	This work
pPD1	pProbe-AT ' containing a mutated <i>peID</i> regulatory region between sites EcoRI and HindIII	2	This work
pPD2	pProbe-AT ' containing a mutated <i>peID</i> regulatory region between sites EcoRI and HindIII	3	This work
pPD3	pProbe-AT ' containing a mutated <i>peID</i> regulatory region between sites EcoRI and HindIII	2,3	This work
pPD4	pProbe-AT ' containing a mutated <i>peID</i> regulatory region between sites EcoRI and HindIII	1, 2, 3	This work
pPD5	pProbe-AT ' containing a mutated <i>peID</i> regulatory region between sites EcoRI and HindIII	1bis, 2, 3	This work
pPD7	pProbe-AT ' containing a mutated <i>peID</i> regulatory region between sites EcoRI and HindIII	1bis	This work
pPD9	pProbe-AT ' containing a mutated <i>peID</i> regulatory region between sites EcoRI and HindIII	1, 1bis, 2, 3	This work
pPD24	pProbe-AT ' containing a mutated <i>peID</i> regulatory region between sites EcoRI and HindIII, with <i>div</i> inactivated	none	This work
pPD26	pProbe-AT ' containing a mutated <i>peID</i> regulatory region between sites EcoRI and HindIII, with CRP2 inactivated	none	This work
pPD27	pProbe-AT ' containing a mutated <i>peID</i> regulatory region between sites EcoRI and HindIII, with CRP1 inactivated	none	This work
pPD28	pProbe-AT ' containing a mutated <i>peID</i> regulatory region between sites EcoRI and HindIII, with CRP1 and CRP2 inactivated	none	This work
pJD0	pJV containing the wild-type <i>peID</i> regulatory region between sites EcoRI and Sall	none	This work
pJD1	pJV containing a mutated <i>peID</i> regulatory region between sites EcoRI and Sall	2	This work
pJD2	pJV containing a mutated <i>peID</i> regulatory region between sites EcoRI and Sall	3	This work
pJD3	pJV containing a mutated <i>peID</i> regulatory region between sites EcoRI and Sall	2,3	This work
pJD9	pJV containing a mutated <i>peID</i> regulatory region between sites EcoRI and Sall	1, 1bis, 2, 3	This work
pJD10	pJV containing a mutated <i>peID</i> regulatory region between sites EcoRI and Sall	1, 1bis	This work
pJD24	pJV containing a mutated <i>peID</i> regulatory region between sites EcoRI and Sall, with <i>div</i> inactivated	none	This work
pID0	pProbe-AT ' containing a wild-type <i>peID</i> regulatory region between sites KpnI and BamHI	none	This work
pID24	pProbe-AT ' containing a mutated <i>peID</i> regulatory region between sites KpnI and BamHI, with <i>div</i> inactivated	none	This work

	inactivated	
pID26	pProbe-AT ' containing a mutated <i>pelD</i> regulatory region between sites KpnI and BamHI, with CRP2 none inactivated	This work
pID27	pProbe-AT ' containing a mutated <i>pelD</i> regulatory region between sites KpnI and BamHI, with CRP1 none inactivated	This work
pID28	pProbe-AT ' containing a mutated <i>pelD</i> regulatory region between sites KpnI and BamHI, with CRP1 none and CRP2 inactivated	This work
Primers		Ref
DNase pel FW	HEX-ACTATAGGGCGAATTGG	This work
DNase pel REV	FAM-AATTAACCCTCACTAAAGG	This work
B0014 FW	AACAGCTGTCACACTGGCTCACCTTC	This work
B0014 REV	AAGAATTCAATAATAAAAAAGCCGATTAATAATC	This work
bla 3B4 fluo	HEX-CAGGAAGGCAAAATGCCGC	This work
pelDfis1bismut FW	GCTGAATTTAAAAtAAAAATTAATTCaAtATTCATAACTAAAAG	This work
pelDfis1bismut REV	CTTTTAGTTATGAATaTTGAATTAATTTTTaTTTTAAATTCAGC	This work
pelDFis1mutFW	TTTCAGATAAAAACiCTTATACATATAGtGAATTTAAAA	This work
pelDFis1mutREV	TTTTAAATTCaCTATATGTATAAGaGTTTTTATCTGAAA	This work
35rev v2 FW	GAATTTAAAAGAAAAATTAATTCtCATTCAACTAAAAGTTACC	This work
35rev v2 REV	GGTAACTTTTAGTTATGAATGaaGAATTAATTTTTCTTTAAATTC	This work
300	ACTATAGGGCGAATTGG	This work
395	CATAAAAAACGAGATTTTGAagtCAAAATAACAATCGAAAACGC	This work
396	GCGTTTTCGATTGTTTATTTTGactTCAAAATCTCGTTTTTTTATG	This work
397	CTAAAAGTTACCGGTCACGAagtCACTTTAGATAAAATTAATTAGC	This work
398	GCTAATTAATTTTATCTAAAGTGactTCGTGACCGGTAACCTTTAG	This work

862

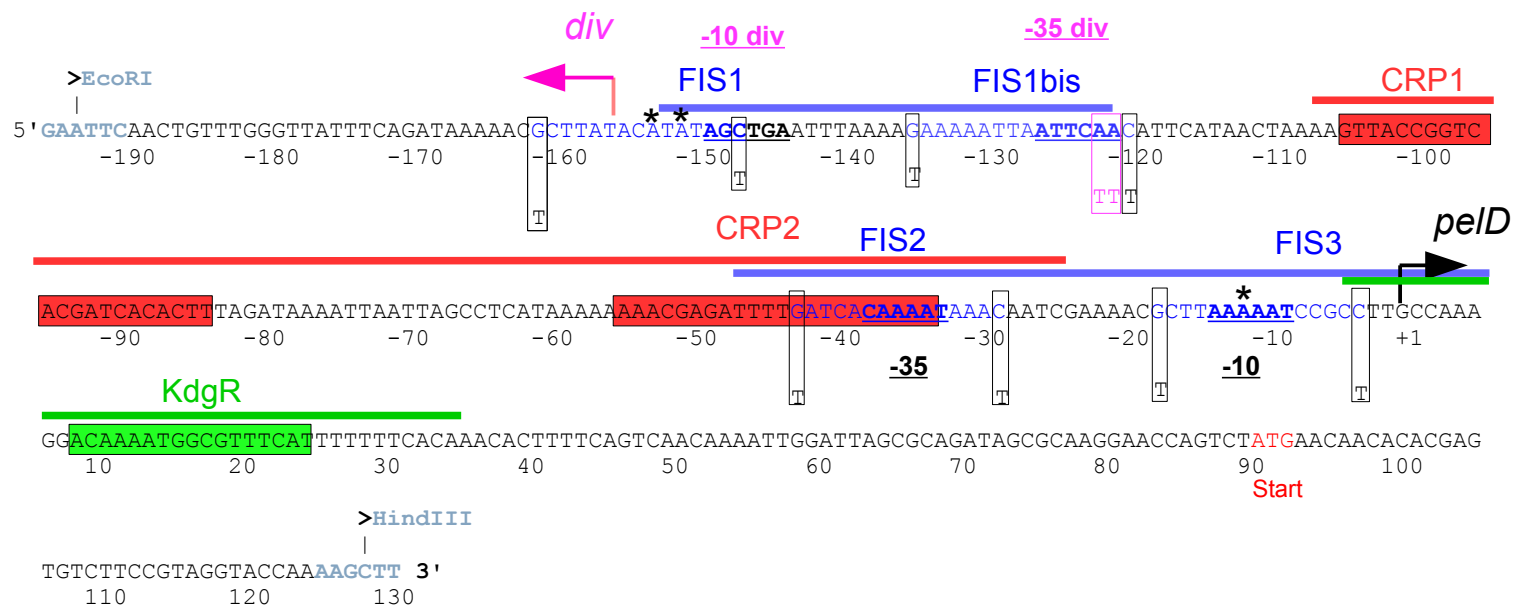

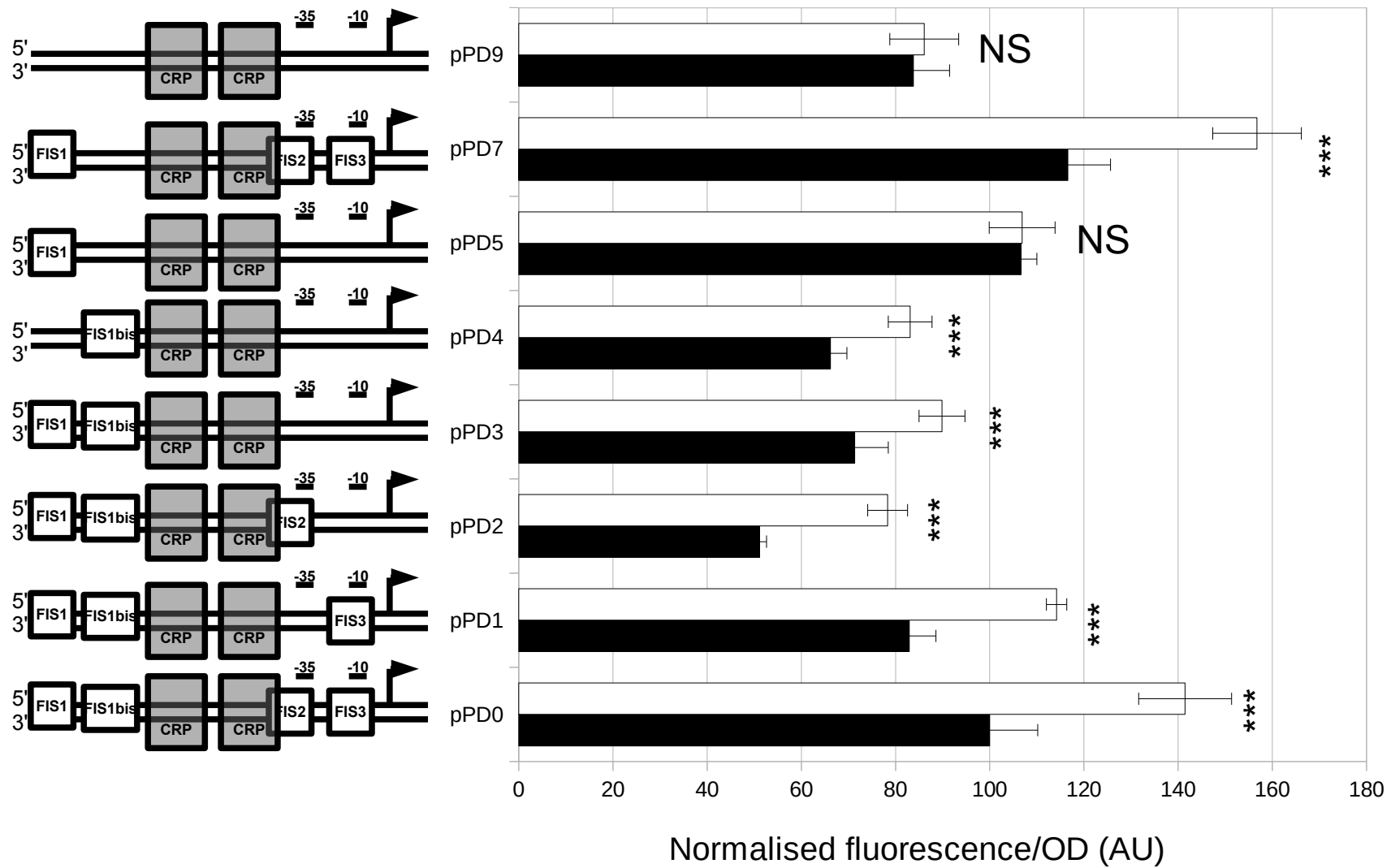

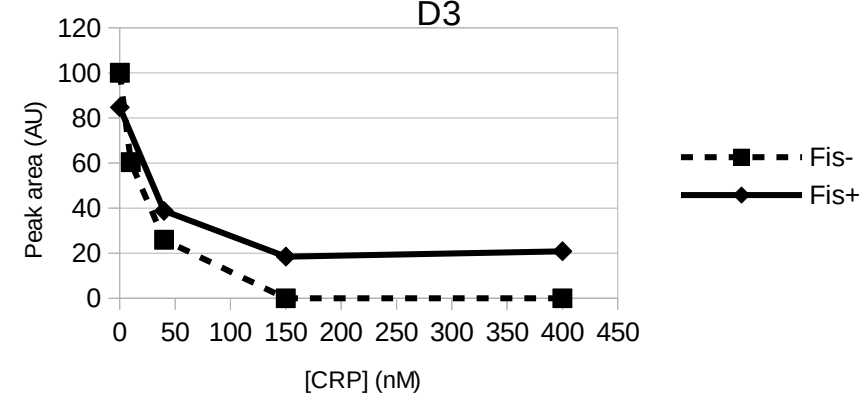
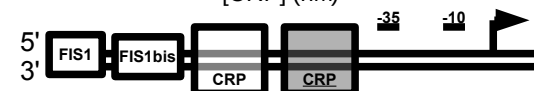
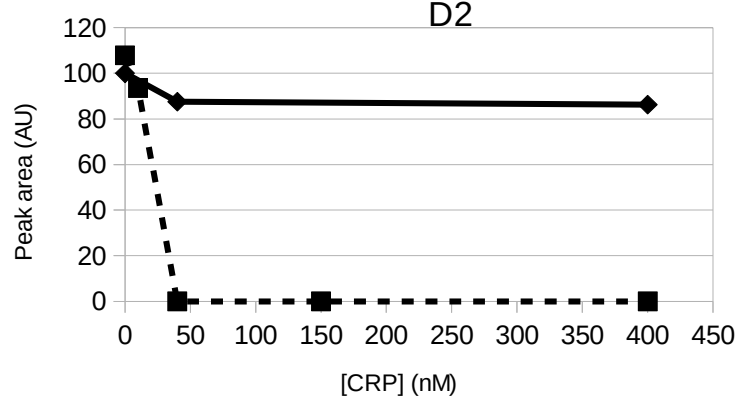
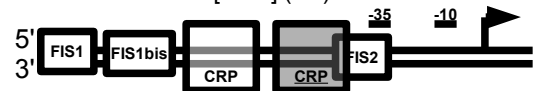
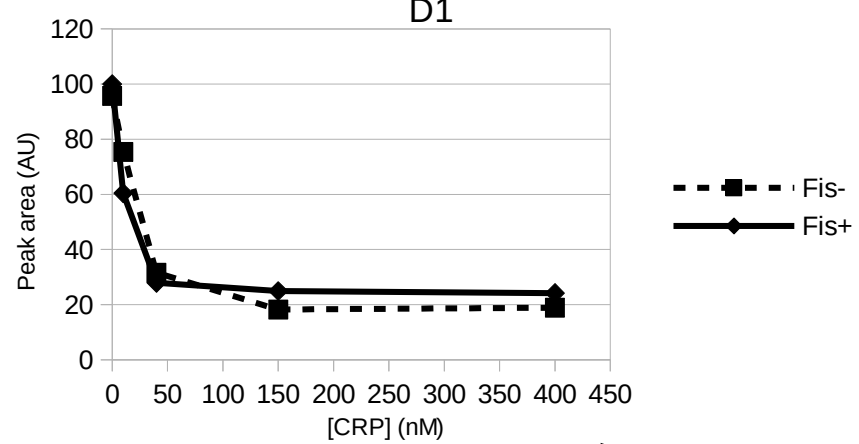
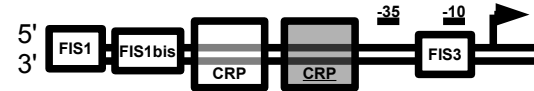
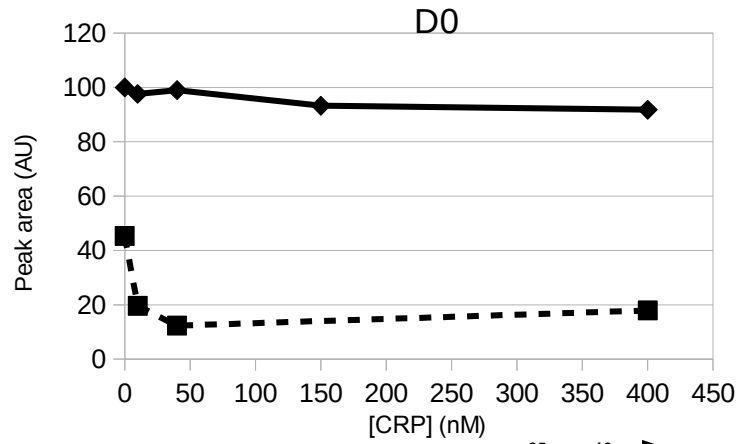
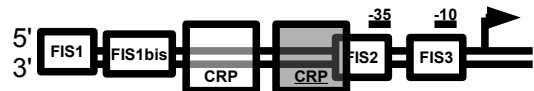

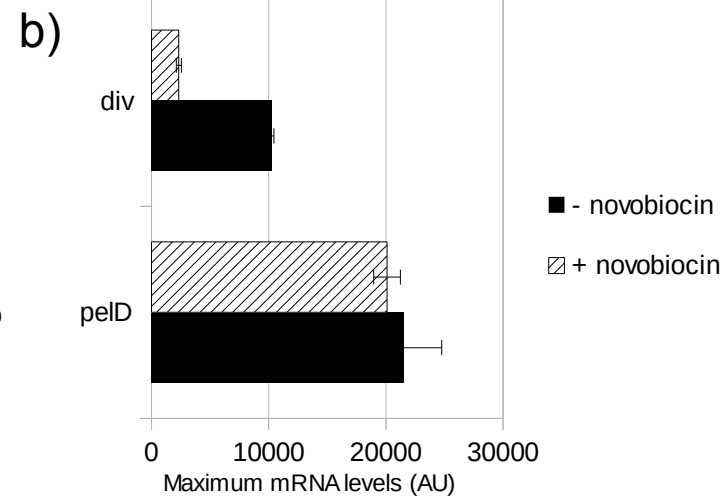
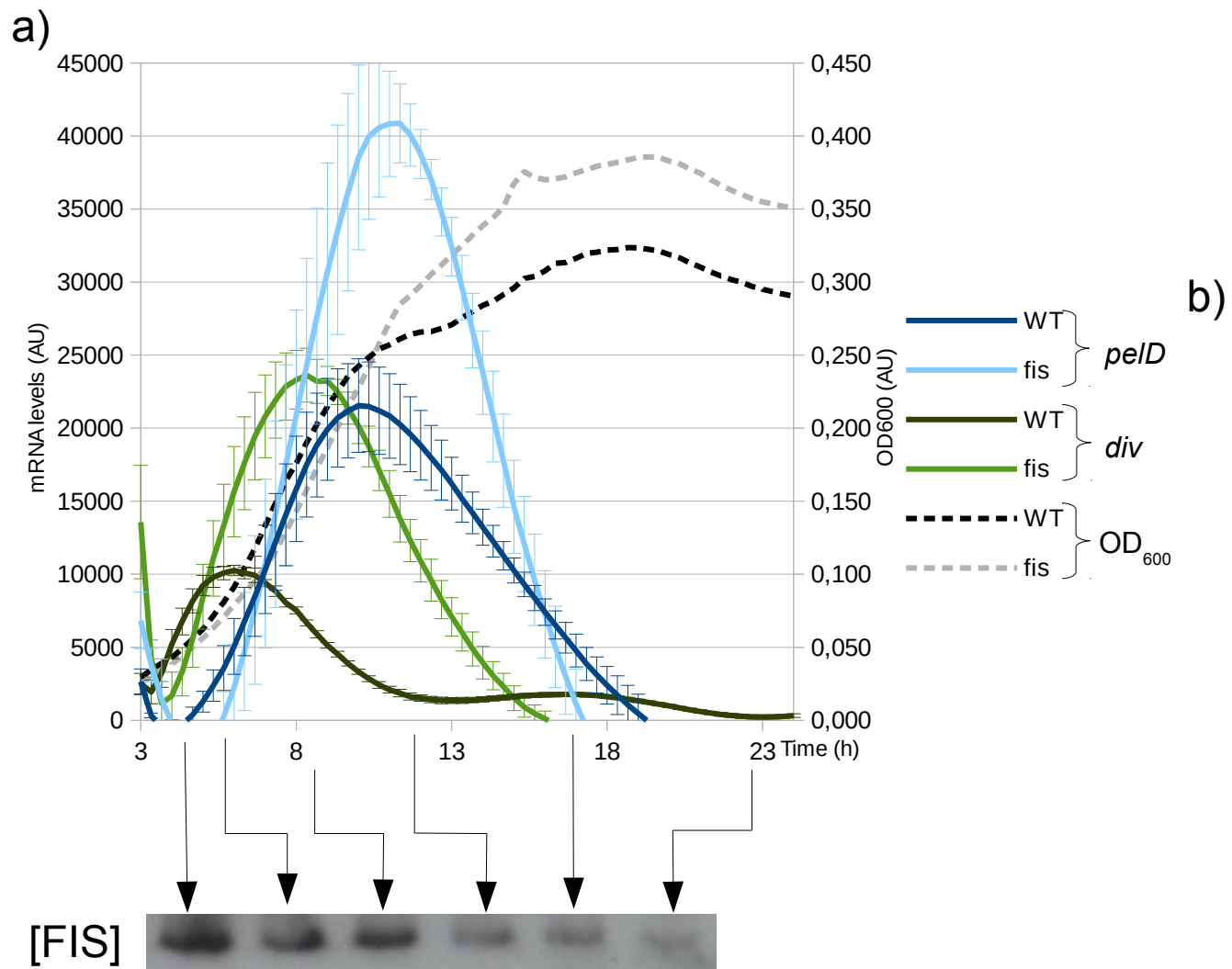

a)

CRP1	GTTACCGGTCACGATCACACTT
inactivated	GTTACCGGTCACGAagtCACTT
<div style="border: 1px solid black; width: 100px; height: 100px; margin: 5px auto;"></div>	
CRP2	AAACGAGATTTTGATCACAAA
inactivated	AAACGAGATTTTGAagtCAAAA
consensus	nnnTGTGAnnnnnnTCACAnnn

b)

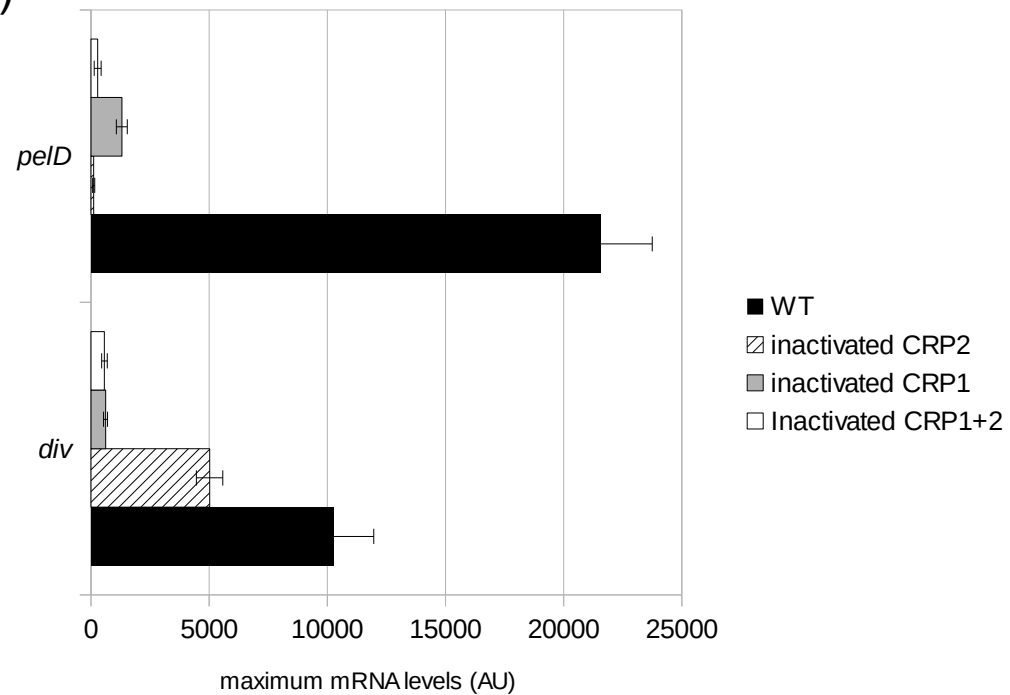

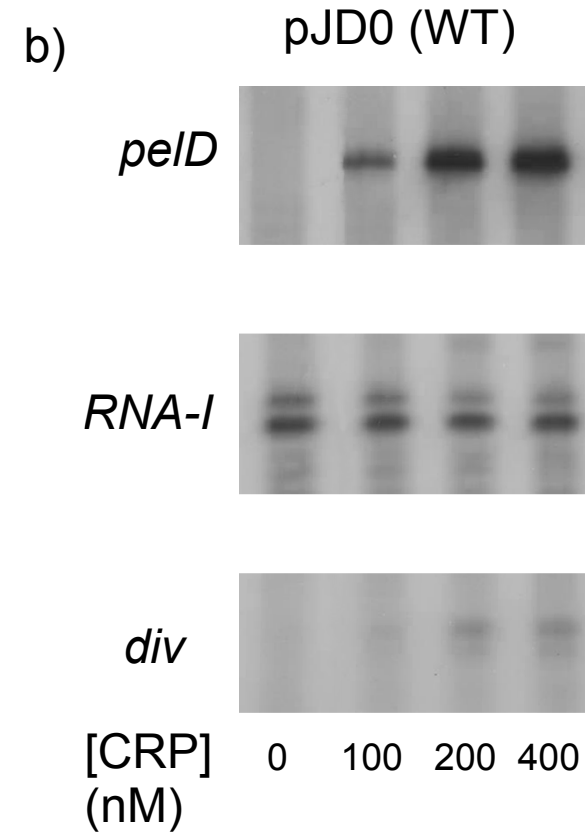
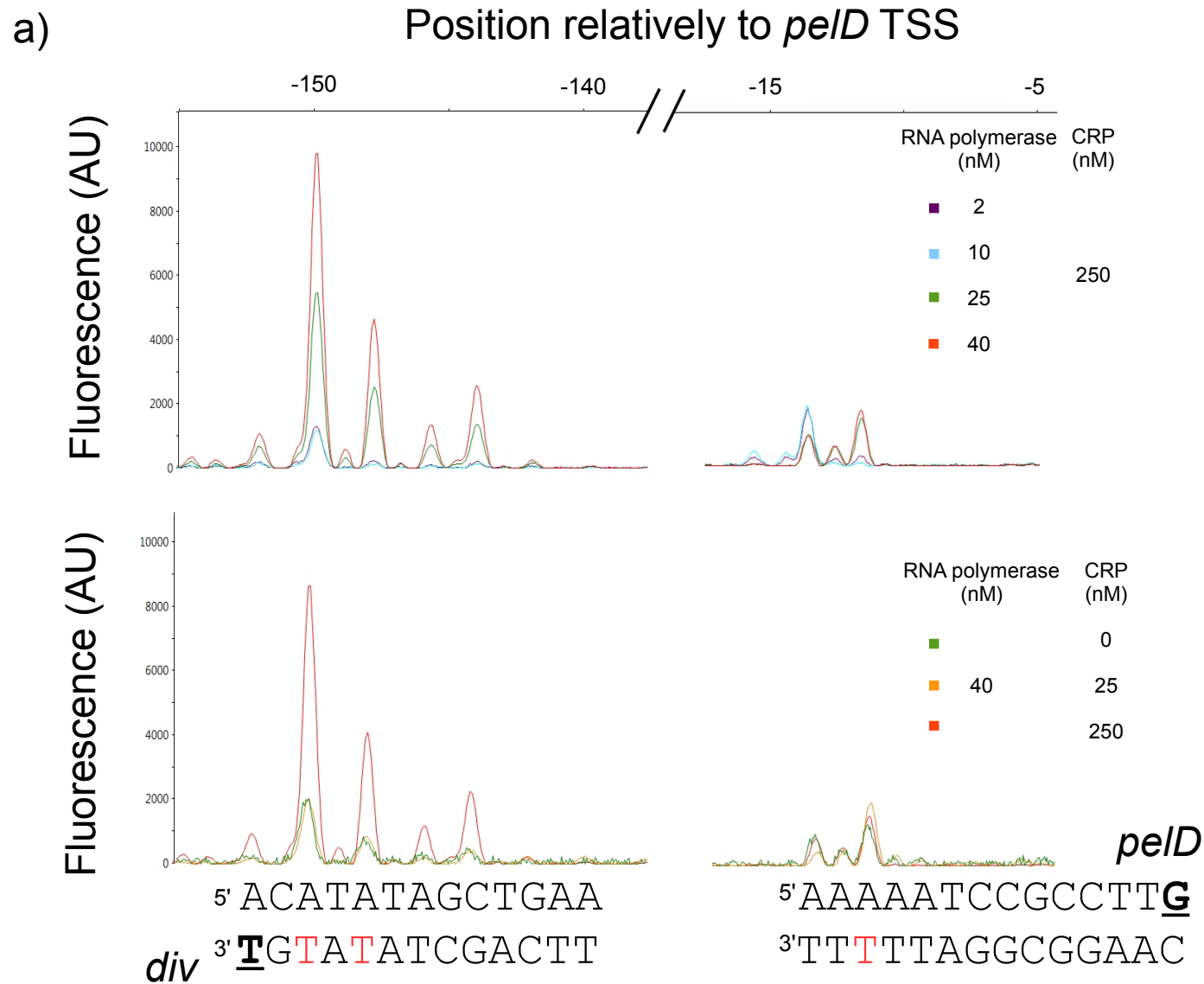

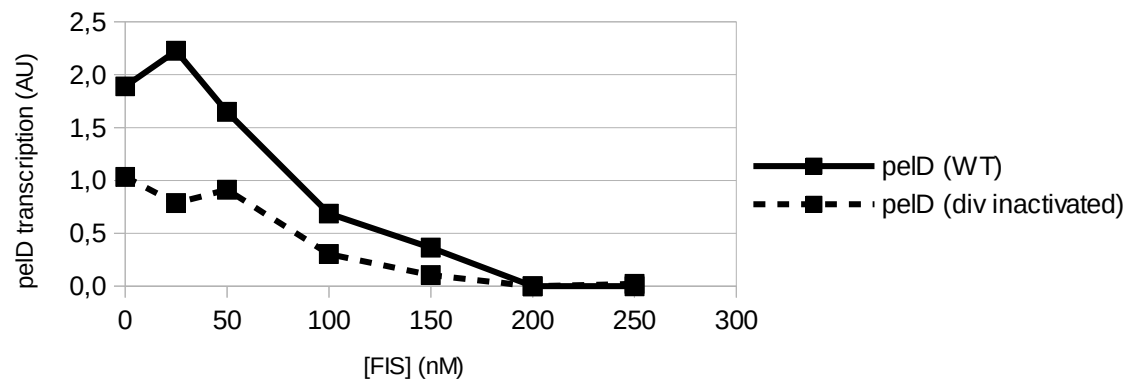
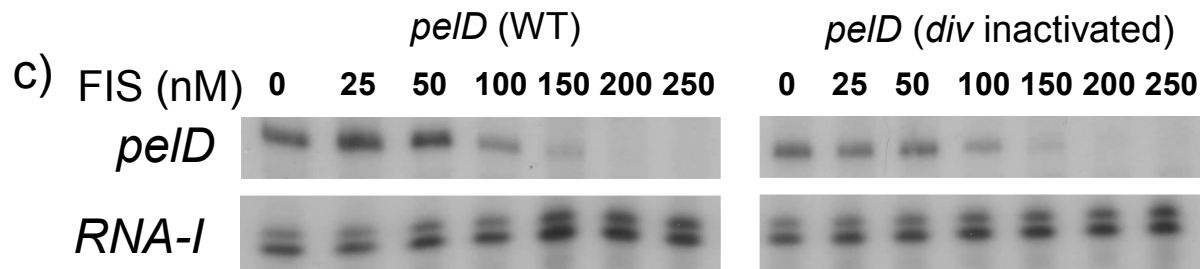
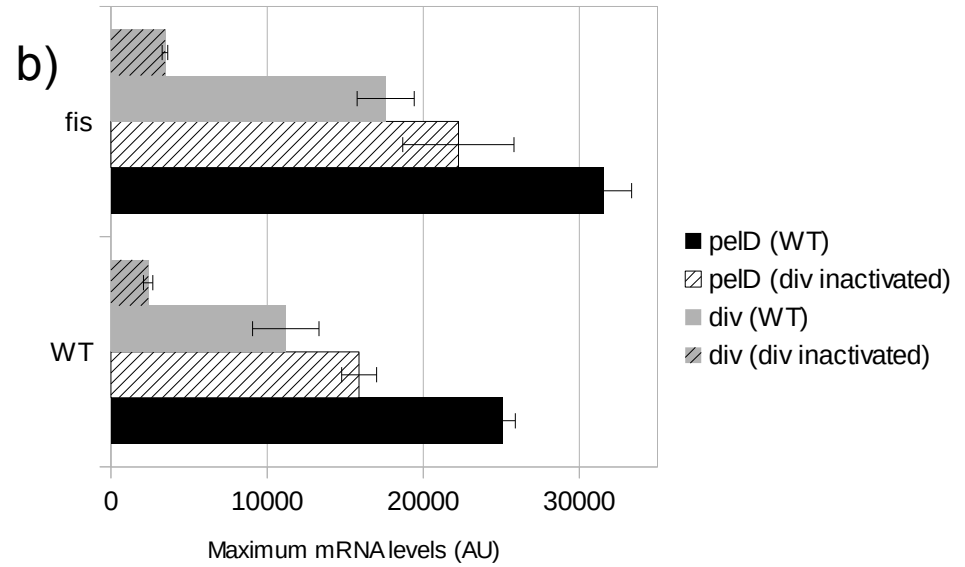
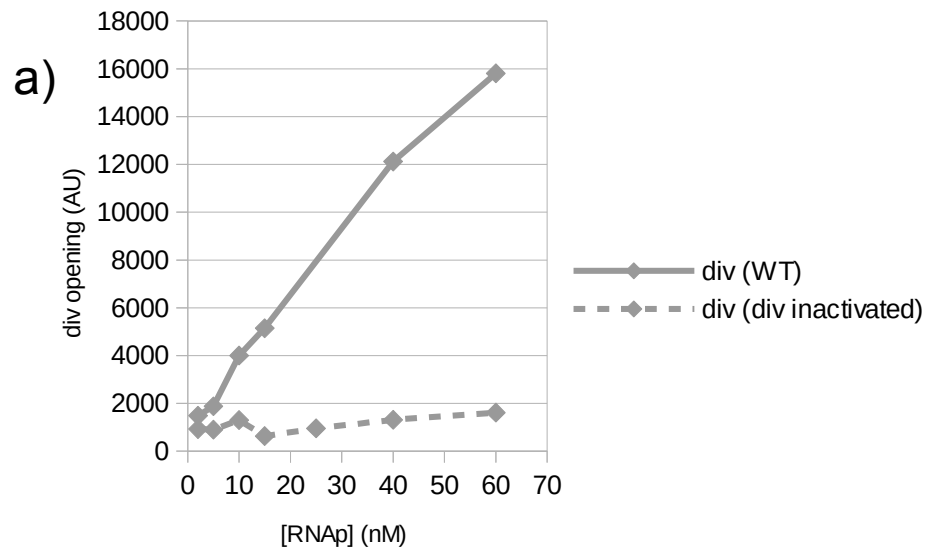

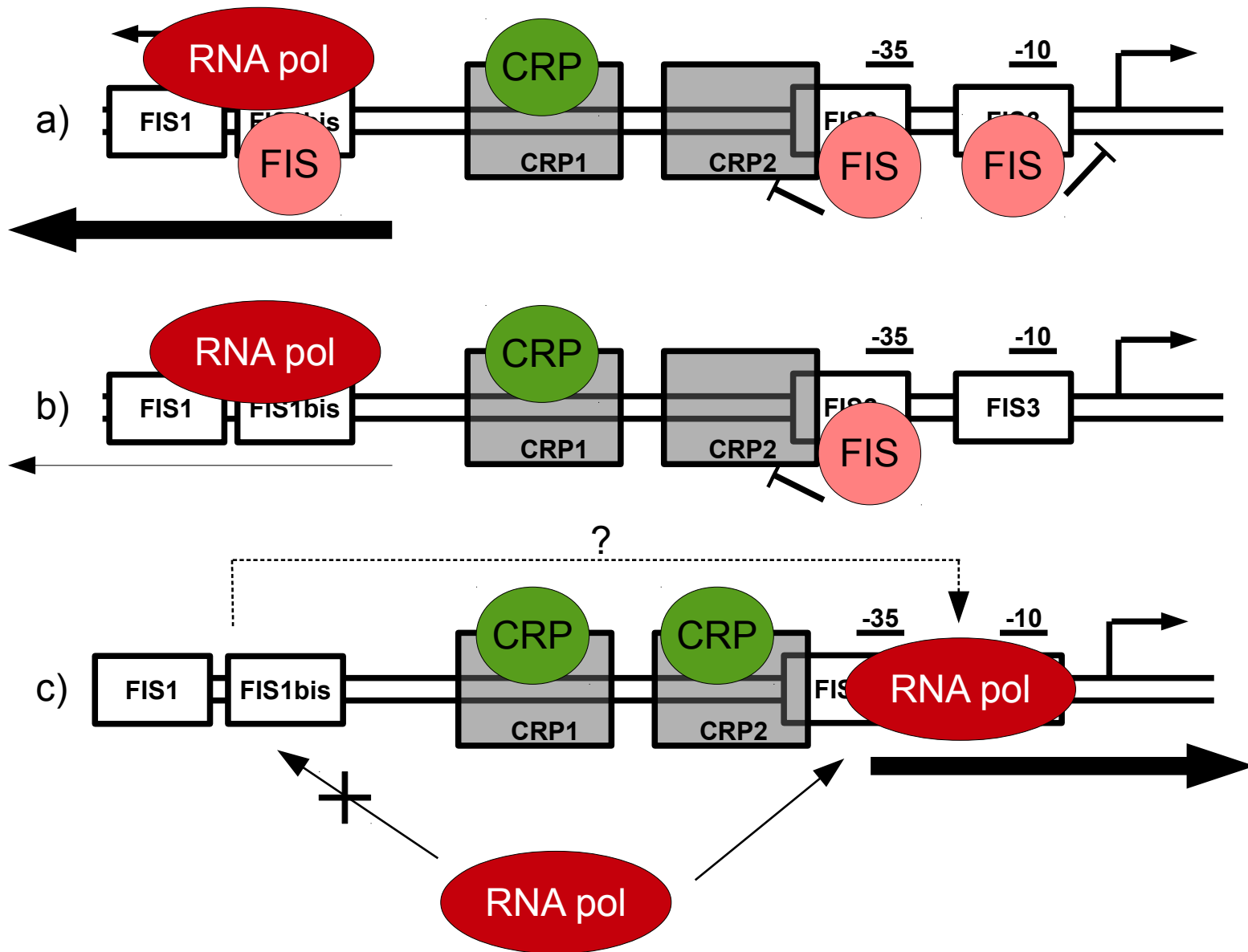

Supplementary

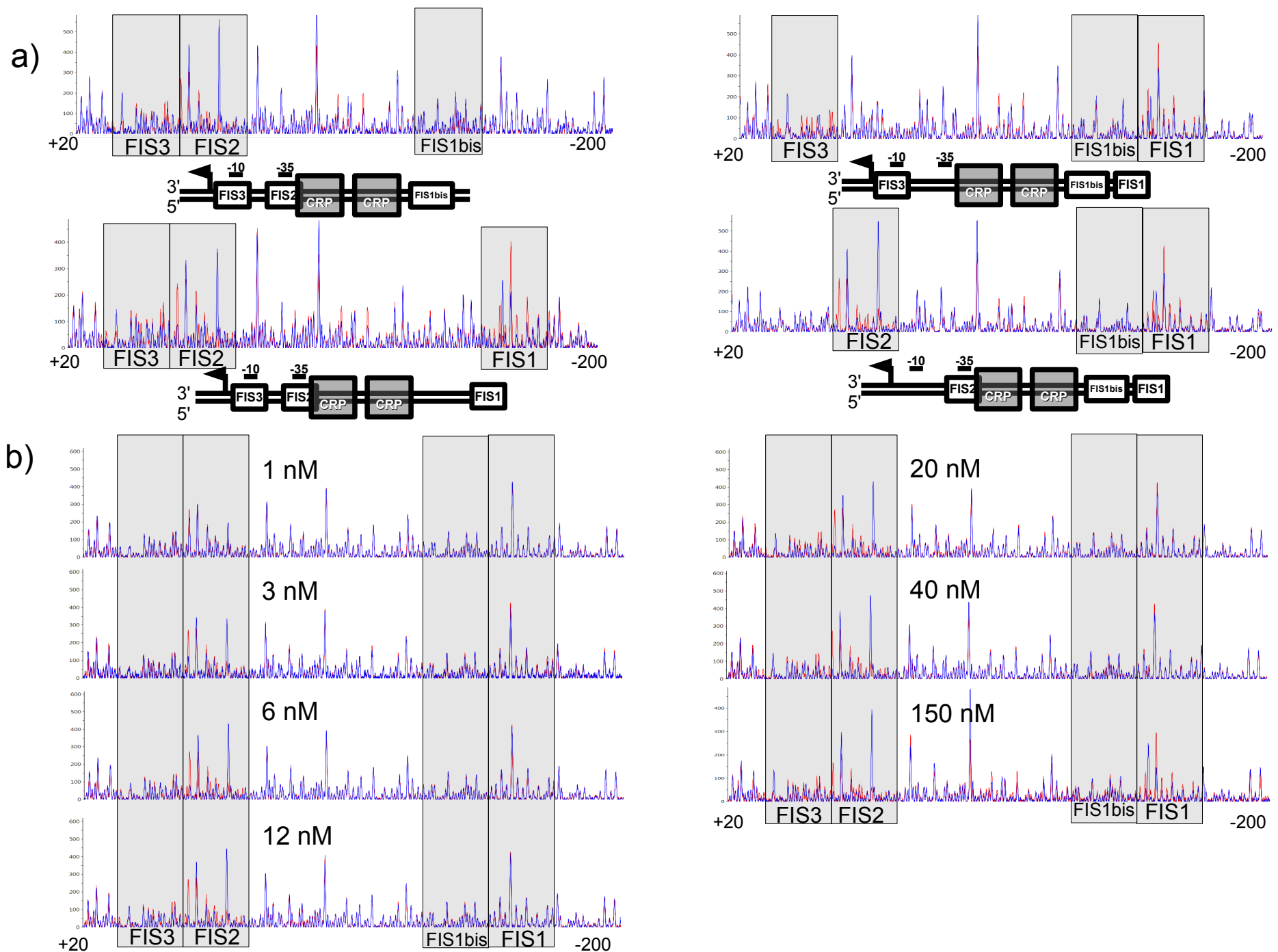

Fig S1: DNase I footprinting of FIS binding in the *peID* regulatory region. DNase I footprinting was performed using fluorescently labelled linear *peID* DNA. The profiles represent the pattern obtained for the template strand. The red and the blue profiles correspond respectively to the samples without and with FIS. a) Profiles for *peID* DNA samples with inactivated FIS1, FIS1bis, FIS2 or FIS3 sites at 150 nM FIS concentration. b) Profiles of the wild type *peID* DNA incubated with increasing concentrations of FIS (from 1 to 150 nM)

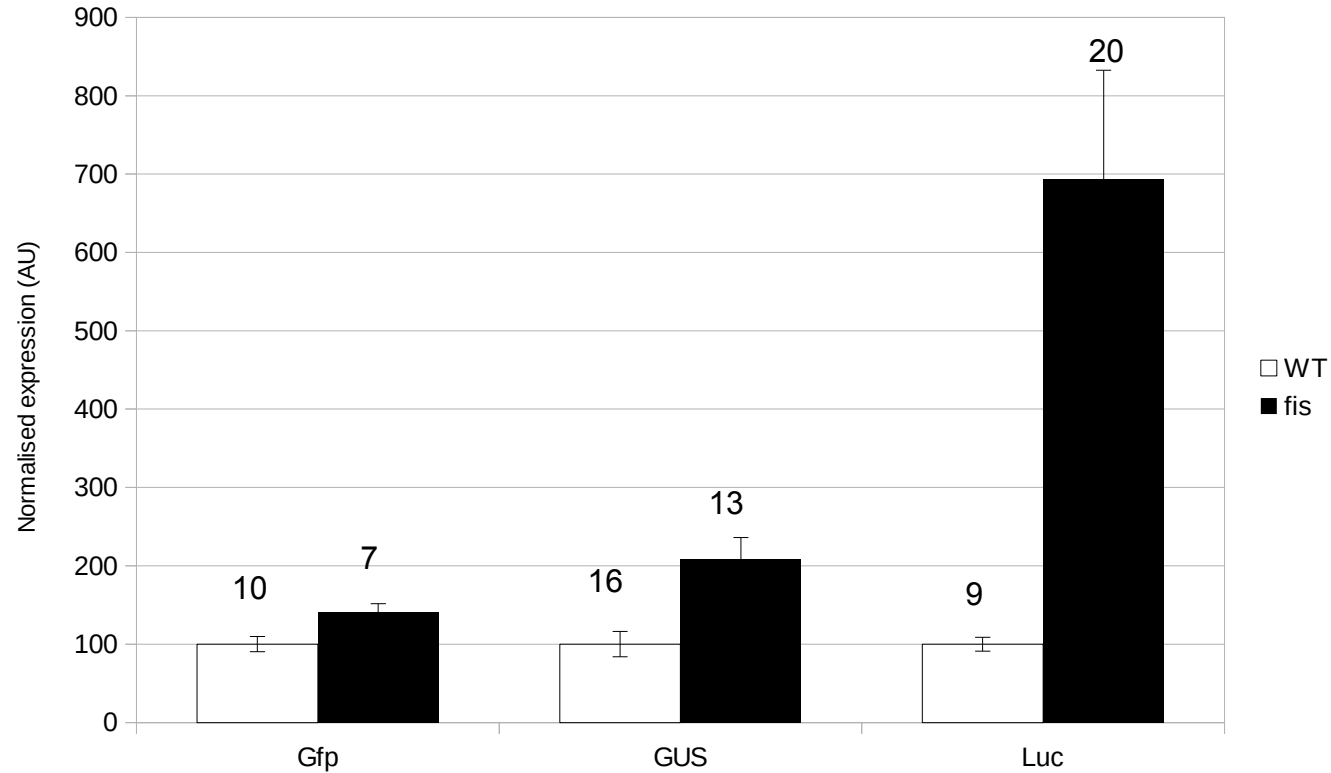

Fig S2: Comparison between the Gfp and Luc reporter systems in *D. dadantii* and the GUS system in *E. coli*. Bacteria transformed with the wild-type *peID* regulatory region in a reporter plasmid were cultured in equivalent conditions (see materials and methods). The normalised fluorescence and GUS specific activity were taken in early stationary phase and the luminescence at the maximum. Data represents the mean of 3 (GUS) to 12 replicates (Gfp and Luc) and error bars represent the standard deviation. Numbers above the error bars indicate the coefficient of variation (in %).

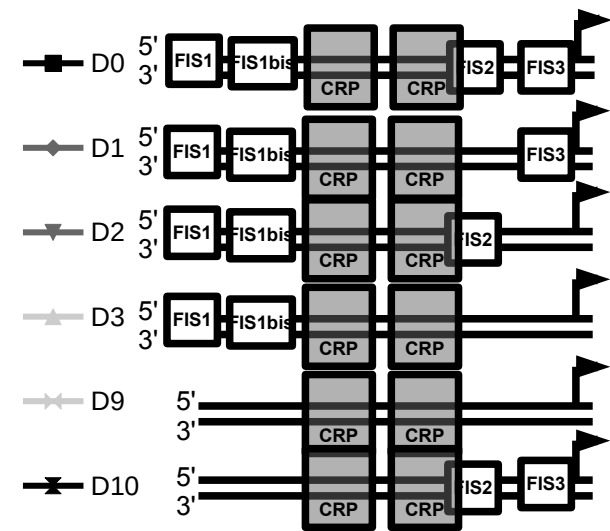
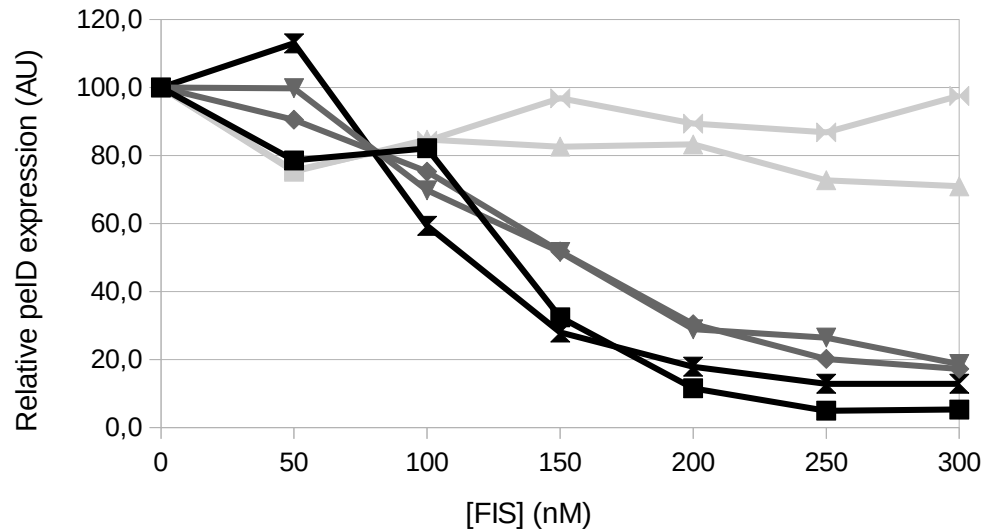
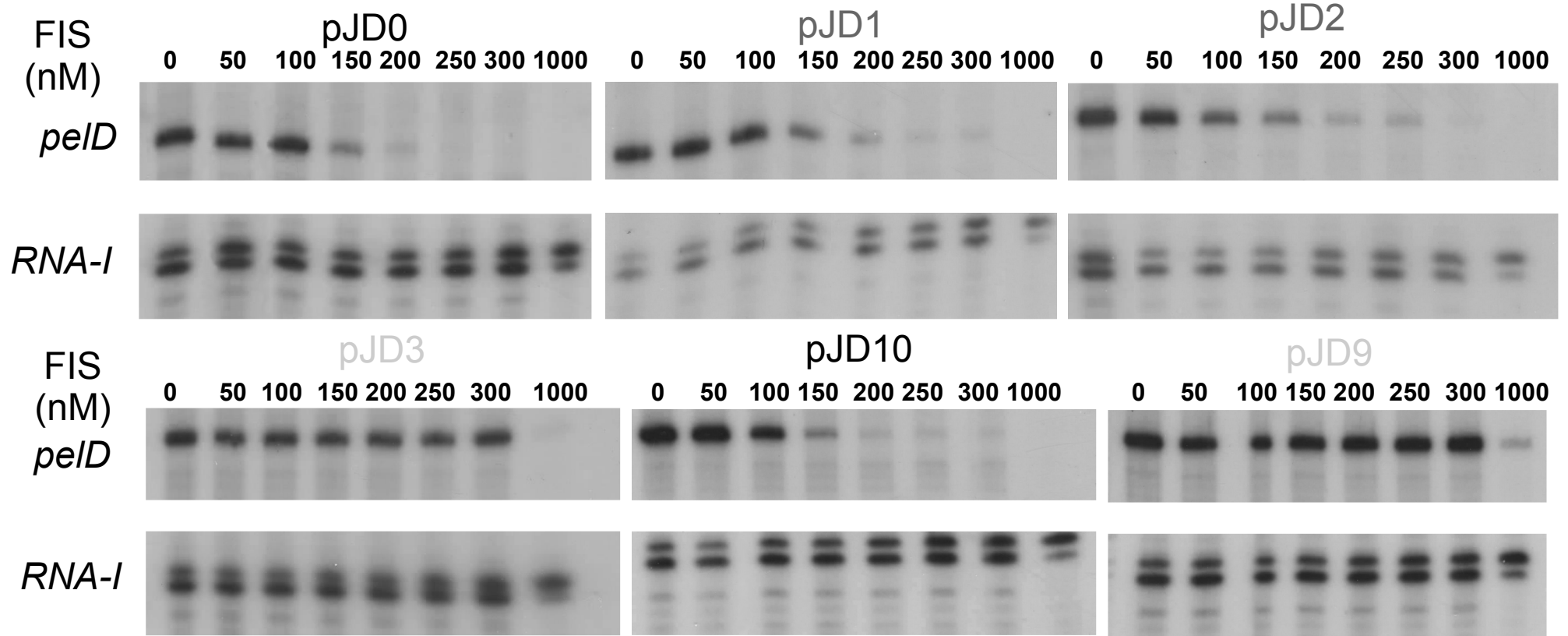

Fig S3: Effect of FIS binding on *peID* transcription *in vitro*. *In vitro* transcription was performed using several *peID* constructs (plasmids D0, D1, D2, D3, D9 and D10 indicated in the bottom left panel) in presence of 100 nM CRP, 40 nM RNA polymerase and varying concentrations of FIS. The *RNA-I* internal control was used as a standard for quantification of the *peID* transcript (bottom right panel).

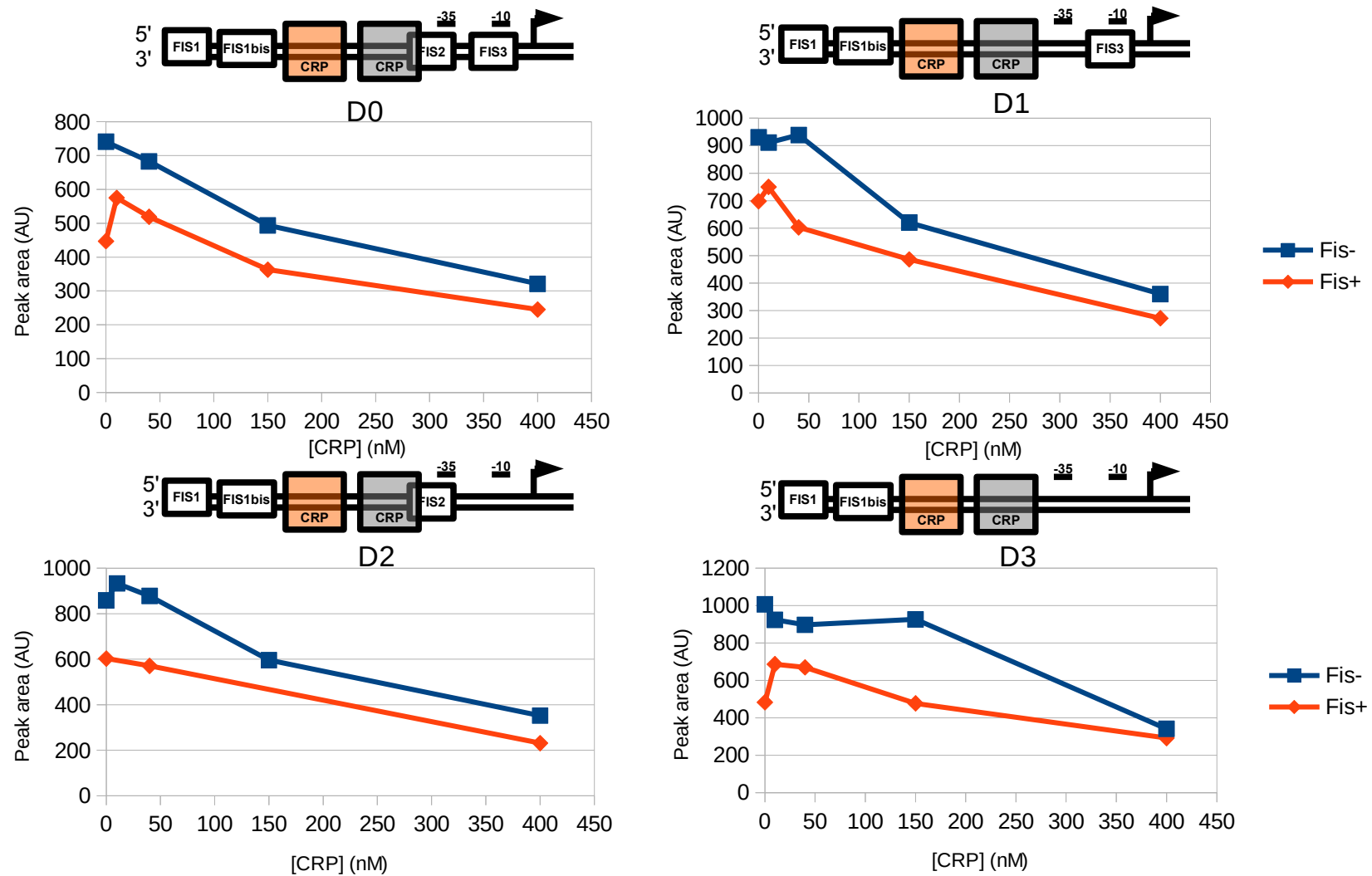

Fig S4: Absence of modification of the CRP1 DNase I footprint by the presence of FIS. A quantitative DNase I footprint was performed on fluorescently labelled *pefD* regulatory regions, in identical conditions as in figure 5. The area of the peaks at one position inside CRP1 (at position -85 relatively to the transcription start site) for different CRP concentrations is represented.

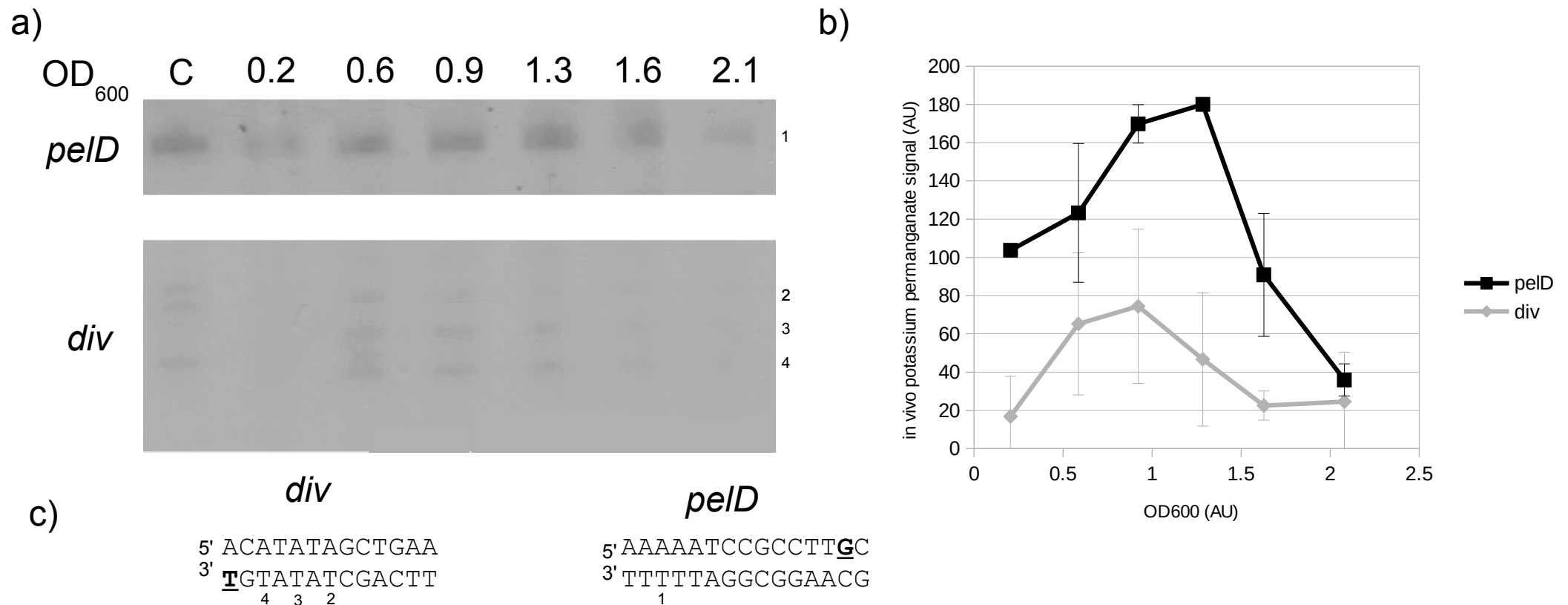

Fig S5: *in vivo* potassium permanganate footprinting of the *pelD* regulatory region. pKD0 (wild-type *pelD*) was transformed into *D. dadantii*. Bacteria were then cultured in M63S + PGA and an *in vivo* potassium permanganate footprinting was performed as described in materials and methods. (a) image of one replicate of the experiment. Lane C corresponds to an *in vitro* potassium permanganate footprinting control performed on the same plasmid with 100 nM CRP and 40 nM RNAP. Bands are numbered and localised in part c of the figure. (b) quantification of the intensity of the bands, represented as mean +/- SD of 2 independent biological replicates. (c) Position of the attacked nucleotides of part a. Both strands are shown and transcription start sites are underlined.

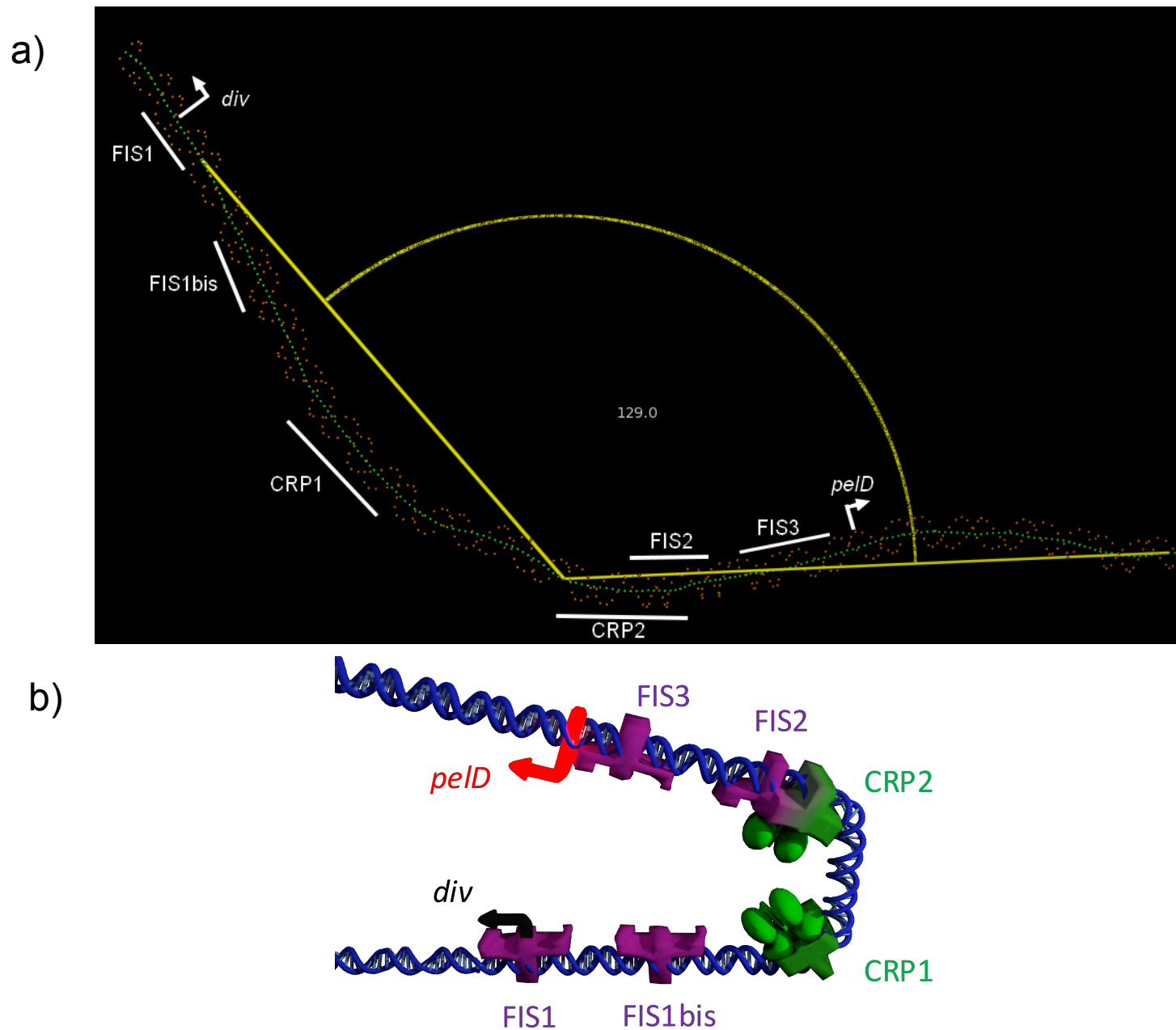

Fig S6: Predicted intrinsic and CRP-induced bending in the *peiD* regulatory region. a) The intrinsic curvature of the *peiD* was modeled using DNACurve (<http://www.lfd.uci.edu/~gohlke/dnacurve/>) and the angle (in yellow) was measured using PyMOL, which corresponds to a bending angle of 51°. The DNA molecule is represented by orange dots and its trajectory in green dots. The main features of the *peiD* regulatory region are shown in white. b) Schematic representation of the CRP-induced bend in the *peiD* regulatory region. Considering that CRP can bend DNA to an angle of around 90°, the presence of both CRP sites could bring *peiD* and *div* in close proximity, facilitating RNAP transfer between both.

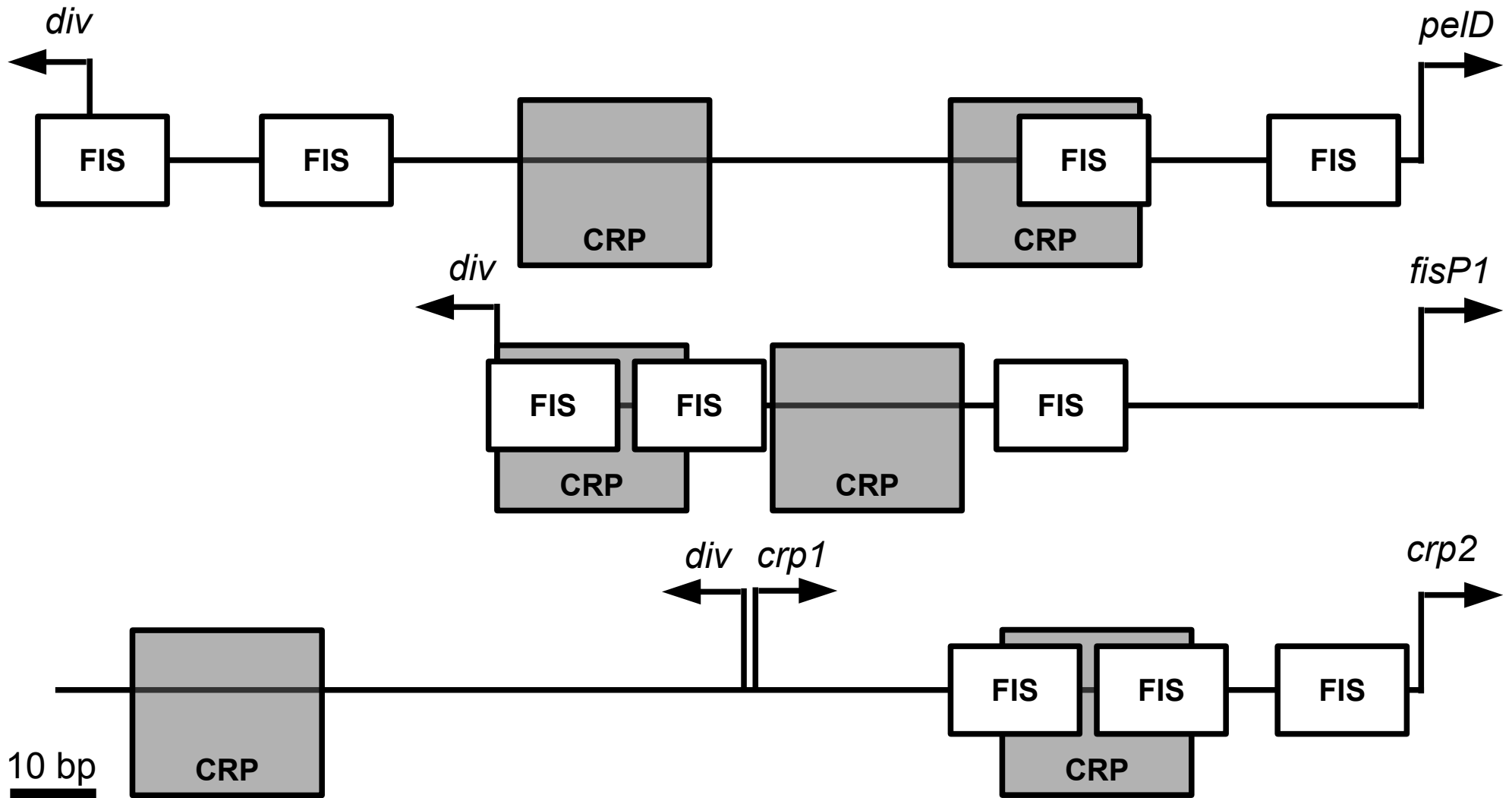

Fig S7: Regulatory structure of 3 different relevant promoters regulated by a divergent promoter. The *pelD* (*D. dadantii*), *fis* (*E. coli*) and *crp* (*E. coli*) regulatory regions are represented. The known promoters are represented with an arrow, FIS sites by white boxes and CRP sites by gray boxes, as described in the literature and this work. The promoter which is coupled to *div* is drawn on the right. All regulatory regions and binding sites are represented to scale. The scale bar in the bottom left corner represents 10 base pairs.

Supplementary table S1: strains, plasmids and oligos used in this study

Strains	Description		Ref
<i>D. dadantii</i>			
3937 (A4922)	Wild-type strain isolated from <i>Saintpaulia ionantha</i>		[1]
A4474	3937 <i>fis</i> ::Cm ^R		[2]
<i>E. coli</i>			
CSH50	F- <i>araBAD-0 M(pro-lac) λ- rpsL-(strR) thi- fimE1::IS1-</i>		[3]
I3506	CSH50 <i>fis</i> ::Cm ^R		[4]
Plasmids	Description	Inactivated FIS sites	Ref
pNB4	Reporter vector with <i>uidA</i> , AmpR		[5]
pProbe-AT '	Reporter vector with <i>gfp</i> , AmpR		[6]
pBluescript SK+	Cloning vector, AmpR		Stratagene
pBluescript KS+	Cloning vector, AmpR		Stratagene
pUCter-Luc-Cm	Reporter vector with <i>luc</i> , AmpR CmR		[7]
pJV	<i>In vitro</i> transcription vector AmpR		This work
pWN2481 (pKD0)	pBluescript KS+ containing the wild-type <i>peID</i> regulatory region between sites EcoRI and HindIII	none	[8]
pKD1	pBluescript SK+ containing a mutated <i>peID</i> regulatory region at site SmaI (T7 promoter oriented)	2	This work
pKD2	pBluescript SK+ containing a mutated <i>peID</i> regulatory region at site SmaI (T7 promoter oriented)	3	This work
pKD3	pBluescript SK+ containing a mutated <i>peID</i> regulatory region at site SmaI (T7 promoter oriented)	2,3	This work
pKD4	pBluescript SK+ containing a mutated <i>peID</i> regulatory region at site SmaI (T7 promoter oriented)	1, 2, 3	This work
pKD5	pBluescript SK+ containing a mutated <i>peID</i> regulatory region at site SmaI (T7 promoter oriented)	1bis, 2, 3	This work
pKD7	pBluescript KS+ containing a mutated <i>peID</i> regulatory region between sites EcoRI and HindIII	1bis	This work
pKD9	pBluescript SK+ containing a mutated <i>peID</i> regulatory region at site SmaI (T7 promoter oriented)	1, 1bis, 2, 3	This work
pKD10	pBluescript KS+ containing a mutated <i>peID</i> regulatory region between sites EcoRI and HindIII	1, 1bis	This work
pKD24	pBluescript KS+ containing a mutated <i>peID</i> regulatory region between sites EcoRI and HindIII, with <i>div</i> inactivated	none	This work
pKD26	pBluescript KS+ containing a mutated <i>peID</i> regulatory region between sites EcoRI and HindIII, with CRP2 inactivated	none	This work
pKD27	pBluescript KS+ containing a mutated <i>peID</i> regulatory region between sites EcoRI and HindIII, with CRP1 inactivated	none	This work
pKD28	pBluescript KS+ containing a mutated <i>peID</i> regulatory region between sites EcoRI and HindIII, with CRP1 and CRP2 inactivated	none	This work
pND0	pNB4 containing the wild-type <i>peID</i> regulatory region between sites EcoRI and HindIII	none	This work
pLD0	pUCter-Luc-Cm containing the wild-type <i>peID</i> regulatory region between sites NheI and XhoI	none	This work
pPD0	pProbe-AT ' containing the wild-type <i>peID</i> regulatory region between sites EcoRI and HindIII	none	This work
pPD1	pProbe-AT ' containing a mutated <i>peID</i> regulatory region between sites EcoRI and HindIII	2	This work
pPD2	pProbe-AT ' containing a mutated <i>peID</i> regulatory region between sites EcoRI and HindIII	3	This work
pPD3	pProbe-AT ' containing a mutated <i>peID</i> regulatory region between sites EcoRI and HindIII	2,3	This work
pPD4	pProbe-AT ' containing a mutated <i>peID</i> regulatory region between sites EcoRI and HindIII	1, 2, 3	This work
pPD5	pProbe-AT ' containing a mutated <i>peID</i> regulatory region between sites EcoRI and HindIII	1bis, 2, 3	This work
pPD7	pProbe-AT ' containing a mutated <i>peID</i> regulatory region between sites EcoRI and HindIII	1bis	This work

pPD9	pProbe-AT ' containing a mutated <i>peID</i> regulatory region between sites EcoRI and HindIII	1, 1bis, 2, 3	This work
pPD24	pProbe-AT ' containing a mutated <i>peID</i> regulatory region between sites EcoRI and HindIII, with <i>div</i> inactivated	none	This work
pPD26	pProbe-AT ' containing a mutated <i>peID</i> regulatory region between sites EcoRI and HindIII, with CRP2 inactivated	none	This work
pPD27	pProbe-AT ' containing a mutated <i>peID</i> regulatory region between sites EcoRI and HindIII, with CRP1 inactivated	none	This work
pPD28	pProbe-AT ' containing a mutated <i>peID</i> regulatory region between sites EcoRI and HindIII, with CRP1 and CRP2 inactivated	none	This work
pJD0	pJV containing the wild-type <i>peID</i> regulatory region between sites EcoRI and Sall	none	This work
pJD1	pJV containing a mutated <i>peID</i> regulatory region between sites EcoRI and Sall	2	This work
pJD2	pJV containing a mutated <i>peID</i> regulatory region between sites EcoRI and Sall	3	This work
pJD3	pJV containing a mutated <i>peID</i> regulatory region between sites EcoRI and Sall	2,3	This work
pJD9	pJV containing a mutated <i>peID</i> regulatory region between sites EcoRI and Sall	1, 1bis, 2, 3	This work
pJD10	pJV containing a mutated <i>peID</i> regulatory region between sites EcoRI and Sall	1, 1bis	This work
pJD24	pJV containing a mutated <i>peID</i> regulatory region between sites EcoRI and Sall, with <i>div</i> inactivated	none	This work
pID0	pProbe-AT ' containing a wild-type <i>peID</i> regulatory region between sites KpnI and BamHI	none	This work
pID24	pProbe-AT ' containing a mutated <i>peID</i> regulatory region between sites KpnI and BamHI, with <i>div</i> inactivated	none	This work
pID26	pProbe-AT ' containing a mutated <i>peID</i> regulatory region between sites KpnI and BamHI, with CRP2 inactivated	none	This work
pID27	pProbe-AT ' containing a mutated <i>peID</i> regulatory region between sites KpnI and BamHI, with CRP1 inactivated	none	This work
pID28	pProbe-AT ' containing a mutated <i>peID</i> regulatory region between sites KpnI and BamHI, with CRP1 and CRP2 inactivated	none	This work

Primers		Ref
DNase <i>peI</i> FW	HEX-ACTATAGGGCGAATTGG	This work
DNase <i>peI</i> REV	FAM-AATTAACCCTCACTAAAGG	This work
B0014 FW	AACAGCTGTCACACTGGCTCACCTTC	This work
B0014 REV	AAGAATTCATAATAAAAAAGCCGATTAATAATC	This work
<i>bla</i> 3B4 fluo	HEX-CAGGAAGGCAAAATGCCGC	This work
<i>peIDfis1bismut</i> FW	GCTGAATTTAAAAATAAATTAATTCAAtATTCATAACTAAAAG	This work
<i>peIDfis1bismut</i> REV	CTTTTAGTTATGAATaTTGAATTAATTTTTaTTTTAAATTCAGC	This work
<i>peIDfis1mut</i> FW	TTTCAGATAAAAACICTTATACATATAGTGAATTTAAAA	This work
<i>peIDfis1mut</i> REV	TTTTAAATTCaACTATATGTATAAGaGTTTTTATCTGAAA	This work
35rev v2 FW	GAATTTAAAAGAAAATAATTCTtCATTcATAACTAAAAGTTACC	This work
35rev v2 REV	GGTAACCTTTTAGTTATGAATGaaGAATTAATTTTTCTTTTAAATTC	This work
300	ACTATAGGGCGAATTGG	This work
395	CATAAAAAACGAGATTTTGAagtCAAAATAACAATCGAAAACGC	This work
396	GCGTTTTCGATTGTTTATTTGactTCAAAATCTCGTTTTTTTTATG	This work
397	CTAAAAGTTACCGGTCACGAagtCACTTTAGATAAAATTAATTAGC	This work
398	GCTAATTAATTTTATCTAAAGTgactTCGTGACCGGTAACCTTTAG	This work

References

- [1] A. Kotoujansky, M. Lemattre, P. Boistard, Utilization of a thermosensitive episome bearing transposon TN10 to isolate Hfr donor strains of

- Erwinia carotovora* subsp. *chrysanthemi*, J. Bacteriol. 150 (1982) 122–131.
- [2] T. Lautier, W. Nasser, The DNA nucleoid-associated protein Fis co-ordinates the expression of the main virulence genes in the phytopathogenic bacterium *Erwinia chrysanthemi*, Mol. Microbiol. 66 (2007) 1474–1490. doi:10.1111/j.1365-2958.2007.06012.x.
- [3] Miller JH, Experiment in Molecular Genetics, Cold Spring Harbor Laboratory Press, 1972.
- [4] G. González-Gil, P. Bringmann, R. Kahmann, FIS is a regulator of metabolism in *Escherichia coli*, Mol. Microbiol. 22 (1996) 21–29. doi:10.1111/j.1365-2958.1996.tb02652.x.
- [5] N. Bardonnnet, A. Trautwetter, G. Couchoux-Luthaud, C. Blanco, Plasmids with the *uidA* reporter gene for the detection of promoters and transcription signals, Mol. Gen. Genet. MGG. 212 (1988) 390–392.
- [6] W.G. Miller, J.H. Leveau, S.E. Lindow, Improved *gfp* and *inaZ* broad-host-range promoter-probe vectors, Mol. Plant-Microbe Interact. MPMI. 13 (2000) 1243–1250. doi:10.1094/MPMI.2000.13.11.1243.
- [7] X. Jiang, P. Sobetzko, W. Nasser, S. Reverchon, G. Muskhelishvili, Chromosomal “Stress-Response” Domains Govern the Spatiotemporal Expression of the Bacterial Virulence Program, mBio. 6 (2015) e00353-15. doi:10.1128/mBio.00353-15.
- [8] C. Rouanet, K. Nomura, S. Tsuyumu, W. Nasser, Regulation of *pelD* and *pelE*, Encoding Major Alkaline Pectate Lyases in *Erwinia chrysanthemi*: Involvement of the Main Transcriptional Factors, J. Bacteriol. 181 (1999) 5948–5957.