



HAL
open science

Fine-grained complexity of coloring unit disks and balls

Biro Csaba, Edouard Bonnet, Dániel Marx, Miltzow Tillmann, Pawel Rzażewski

► **To cite this version:**

Biro Csaba, Edouard Bonnet, Dániel Marx, Miltzow Tillmann, Pawel Rzażewski. Fine-grained complexity of coloring unit disks and balls. *Journal of Computational Geometry*, 2018. hal-01991656

HAL Id: hal-01991656

<https://hal.science/hal-01991656>

Submitted on 23 Jan 2019

HAL is a multi-disciplinary open access archive for the deposit and dissemination of scientific research documents, whether they are published or not. The documents may come from teaching and research institutions in France or abroad, or from public or private research centers.

L'archive ouverte pluridisciplinaire **HAL**, est destinée au dépôt et à la diffusion de documents scientifiques de niveau recherche, publiés ou non, émanant des établissements d'enseignement et de recherche français ou étrangers, des laboratoires publics ou privés.

1 **Fine-grained complexity of coloring unit disks and balls***2 *Csaba Biro*[†], *Édouard Bonnet*[‡], *Dániel Marx*[§], *Tillmann Miltzow*[¶], *Paweł Rzazewski*^{||}

3 ABSTRACT. On planar graphs, many classic algorithmic problems enjoy a certain “square
 4 root phenomenon” and can be solved significantly faster than what is known to be possible
 5 on general graphs: for example, INDEPENDENT SET, 3-COLORING, HAMILTONIAN CYCLE,
 6 DOMINATING SET can be solved in time $2^{O(\sqrt{n})}$ on an n -vertex planar graph, while no $2^{o(n)}$
 7 algorithms exist for general graphs, assuming the Exponential Time Hypothesis (ETH).
 8 The square root in the exponent seems to be best possible for planar graphs: assuming the
 9 ETH, the running time for these problems cannot be improved to $2^{o(\sqrt{n})}$. In some cases, a
 10 similar speedup can be obtained for 2-dimensional geometric problems, for example, there
 11 are $2^{O(\sqrt{n} \log n)}$ time algorithms for INDEPENDENT SET on unit disk graphs or for TSP on
 12 2-dimensional point sets.

13 In this paper, we explore whether such a speedup is possible for geometric coloring
 14 problems. On the one hand, geometric objects can behave similarly to planar graphs: 3-
 15 COLORING can be solved in time $2^{O(\sqrt{n})}$ on the intersection graph of n disks in the plane and,
 16 assuming the ETH, there is no such algorithm with running time $2^{o(\sqrt{n})}$. On the other hand,
 17 if the number ℓ of colors is part of the input, then no such speedup is possible: Coloring the
 18 intersection graph of n unit disks with ℓ colors cannot be solved in time $2^{o(n)}$, assuming the
 19 ETH. More precisely, we exhibit a smooth increase of complexity as the number ℓ of colors
 20 increases: If we restrict the number of colors to $\ell = \Theta(n^\alpha)$ for some $0 \leq \alpha \leq 1$, then the
 21 problem of coloring the intersection graph of n disks with ℓ colors

- 22 • can be solved in time $\exp\left(O\left(n^{\frac{1+\alpha}{2}} \log n\right)\right) = \exp\left(O\left(\sqrt{n\ell} \log n\right)\right)$, and
- 23 • cannot be solved in time $\exp\left(o\left(n^{\frac{1+\alpha}{2}}\right)\right) = \exp\left(o\left(\sqrt{n\ell}\right)\right)$, even on unit disks, unless
- 24 the ETH fails.

25 More generally, we consider the problem of coloring d -dimensional balls in the Eu-
 26 clidean space and obtain analogous results showing that the problem

*Supported by the European Research Council (ERC) Starting Grant PARAMTIGHT (no. 280152) and Consolidator Grant SYSTEMATICGRAPH (no. 725978).

[†]*Department of Mathematics, University of Louisville, csaba.biro@louisville.edu*

[‡]*Univ Lyon, CNRS, ENS de Lyon, Université Claude Bernard Lyon 1, LIP UMR5668, France, edouard.bonnet@dauphine.fr*

[§]*Institute for Computer Science and Control, Hungarian Academy of Sciences (MTA SZTAKI), dmarx@cs.bme.hu*

[¶]*Université libre de Bruxelles (ULB), Brussels, Belgium, t.miltzow@gmail.com*

^{||}*Faculty of Mathematics and Information Science, Warsaw University of Technology, p.rzazewski@mini.pw.edu.pl*

- 27 • can be solved in time $\exp\left(O\left(n^{\frac{d-1+\alpha}{d}} \log n\right)\right) = \exp\left(O\left(n^{1-1/d} \ell^{1/d} \log n\right)\right)$, and
- 28 • cannot be solved in time $\exp\left(O\left(n^{\frac{d-1+\alpha}{d}-\epsilon}\right)\right) = \exp\left(O\left(n^{1-1/d-\epsilon} \ell^{1/d}\right)\right)$ for any $\epsilon > 0$,
- 29 even for unit balls, unless the ETH fails.

30 Finally, we prove that fatness is crucial to obtain subexponential algorithms for
 31 coloring. We show that existence of an algorithm coloring an intersection graph of segments
 32 using a constant number of colors in time $2^{o(n)}$ already refutes the ETH.

33 1 Introduction

34 There are many examples of 2-dimensional geometric problems that are NP-hard, but can
 35 be solved significantly faster than the general case of the problem: for example, there are
 36 $2^{O(\sqrt{n} \log n)}$ time algorithms for TSP on 2-dimensional point sets or for INDEPENDENT SET
 37 on the intersection graph of unit disks in the plane [1, 23, 30], while only $2^{O(n)}$ time algo-
 38 rithms are known for these problems on general metrics or on arbitrary graphs. There is
 39 evidence that these running times are essentially best possible: under the Exponential Time
 40 Hypothesis (ETH) of Impagliazzo, Paturi, and Zane [19], the $2^{O(\sqrt{n} \log n)}$ time algorithms
 41 for these 2-dimensional problems cannot be improved to $2^{o(\sqrt{n})}$, and the $2^{O(n)}$ algorithms
 42 for the general case cannot be improved to $2^{o(n)}$. Thus running times with a square root in
 43 the exponent seems to be the natural complexity behavior of many 2-dimensional geometric
 44 problems. There is a similar “square root phenomenon” for planar graphs, where running
 45 times of the form $2^{O(\sqrt{n})}$, $2^{O(\sqrt{k})} \cdot n^{O(1)}$, or $n^{O(\sqrt{k})}$ are known for a number of problems
 46 [4, 7–15, 17, 18, 20, 21, 23, 27, 28, 31]. More generally, for d -dimensional geometric prob-
 47 lems, running times of the form $2^{O(n^{1-1/d})}$ or $n^{O(k^{1-1/d})}$ appear naturally, and Marx and
 48 Sidiropoulos [24] showed that, assuming the ETH, this form of running time is essentially
 49 best possible for some problems.

50 In this paper, we explore whether such a speedup is possible for geometric coloring
 51 problems. Deciding whether an n -vertex graph has an ℓ -coloring can be done in time $\ell^{O(n)}$
 52 by brute force, or in time $2^{O(n)}$ using dynamic programming. On planar graphs, we can
 53 decide 3-colorability significantly faster in time $2^{O(\sqrt{n})}$, for example, by observing that planar
 54 graphs have treewidth $O(\sqrt{n})$. Let us consider now the problem of coloring the intersection
 55 graph of a set of disks in the 2-dimensional plane, that is, assigning a color to each disk
 56 such that if two disks intersect, then they receive different colors. For a constant number of
 57 colors, geometric objects can behave similarly to planar graphs: 3-COLORING can be solved
 58 in time $2^{O(\sqrt{n})}$ on the intersection graph of n disks in the plane and, assuming the ETH,
 59 there is no such algorithm with running time $2^{o(\sqrt{n})}$. However, while every planar graph
 60 is 4-colorable, disks graphs can contain arbitrary large cliques, and hence ℓ -colorability is
 61 a meaningful question for larger, non-constant, values of ℓ as well. We show that if the
 62 number ℓ of colors is part of the input and can be up to $\Theta(n)$, then, surprisingly, no speedup
 63 is possible: Coloring the intersection graph of n disks with ℓ colors cannot be solved in
 64 time $2^{o(n)}$, assuming the ETH. Thus we understand the complexity of the problem when
 65 the number of colors is a constant or $\Theta(n)$, but what exactly happens between these two

66 extremes? Our main 2-dimensional result exhibits a smooth increase of complexity as the
 67 number ℓ of colors increases.

68 **Theorem 1.** *For any fixed $0 \leq \alpha \leq 1$, the problem of coloring the intersection graph of n
 69 disks with $\ell = \Theta(n^\alpha)$ colors*

- 70 • *can be solved in time $2^{O(n^{\frac{1+\alpha}{2}} \log n)} = 2^{O(\sqrt{n\ell} \log n)}$, and*
- 71 • *cannot be solved in time $2^{o(n^{\frac{1+\alpha}{2}})} = 2^{o(\sqrt{n\ell})}$, even for unit disks, unless the ETH fails.*

72 Let us remark that when we express the running time as a function of *two* parameters
 73 (number n of disks and number ℓ of colors) it is not obvious what we mean by claiming that a
 74 running time is “best possible.” In the statement of Theorem 1, we follow Fomin et al. [16],
 75 who studied the complexity of a two-parameter clustering problem in a similar way: We
 76 restrict the parameter ℓ to be $\Theta(n^\alpha)$ for some fixed α , and determine the complexity under
 77 this restriction as a univariate function of n .

78 The proofs of both statements in Theorem 1 are not very specific to disks and can be
 79 easily adapted to, say, axis-parallel squares or other fat objects. However, it seems that the
 80 requirement of fatness is essential for this type of complexity behavior as, for example, the
 81 coloring of the intersection graphs of line segments does not admit any speedup compared
 82 to the $2^{O(n)}$ algorithm, even for a constant number of colors.

83 **Theorem 2.** *There is no $2^{o(n)}$ time algorithm for 6-COLORING the intersection graph of
 84 line segments in the plane, unless the ETH fails.*

85 We actually show a stronger statement that proves the lower bound even if the
 86 segments have only two directions. Let us mention that very recently Theorem 2 was
 87 strengthened by a subset of authors, who modified the argument to show that the same lower
 88 bound holds even for 4-COLORING, while for 3-COLORING there exists a subexponential
 89 algorithm [2]. We include the proof of Theorem 2 for the sake of completeness.

90 We observe that both hardness proofs crucially use that the segments can be of
 91 different (non-constant) lengths. For unit segments, only a weaker lower bound was shown
 92 in [2]: assuming the ETH, there is no algorithm for 4-COLORING an intersection graph of
 93 unit segments in time $2^{o(n^{2/3})}$. The exact complexity of coloring the intersection graphs of
 94 unit line segments remains open.

95 How does the complexity change if we look at the generalization of the coloring
 96 problem into higher dimensions? It is known for some problems that if we generalize the
 97 problem from two dimensions to d dimensions, then the square root in the exponent of
 98 the running time changes to a $1 - 1/d$ power, which makes the running time closer and
 99 closer to the running time of the brute force as d increases [24]. This may suggest that the
 100 d -dimensional generalization of Theorem 1 should have $(n\ell)^{1-1/d}$ in the exponent instead
 101 of $\sqrt{n\ell}$. Actually, this is not exactly what happens:¹ the correct exponent appears to be

¹The astute reader can quickly realize that $2^{O((n\ell)^{1-1/d})}$ is certainly not the correct answer when, say,
 $\ell = \Theta(n)$ and $d = 3$: then $2^{O((n\ell)^{1-1/d})} = 2^{O(n^{4/3})}$ is worse than the running time $2^{O(n)}$ possible even for
 general graphs!

102 $n^{1-1/d}$ times $\ell^{1/d}$. That is, as d increases, the running time becomes less and less sensitive
 103 to the number of colors and approaches $2^{O(n)}$, even for constant number of colors.

104 **Theorem 3.** *For any fixed $0 \leq \alpha \leq 1$ and dimension $d \geq 2$, the problem of coloring the*
 105 *intersection graph of n balls in the d -dimensional Euclidean space with $\ell = \Theta(n^\alpha)$ colors*

- 106 • *can be solved in time $2^{O\left(n^{\frac{d-1+\alpha}{d} \log n}\right)} = 2^{O(n^{1-1/d} \ell^{1/d} \log n)}$, and*
- 107 • *cannot be solved in time $2^{O\left(n^{\frac{d-1+\alpha}{d} - \epsilon}\right)}$ for any $\epsilon > 0$, even for unit balls, unless the*
 108 *ETH fails.*

109 Note that the lower bound of Theorem 3 is slightly weaker than the lower bound
 110 of Theorem 1: we only prove that the exponent of n cannot be improved by any positive
 111 $\epsilon > 0$.

112 **Techniques.** The upper bounds of Theorems 1 and 3 follow fairly easily using
 113 standard techniques. Clearly, the problem of coloring disks with ℓ colors is non-trivial only
 114 if every point of the plane is contained in at most ℓ disks: otherwise the intersection graph
 115 would contain a clique of size larger than ℓ and we would immediately know that there is no
 116 ℓ -coloring. On the other hand, if every point is contained in at most ℓ of the n disks, then
 117 it is known that there is a balanced separator of size $O(\sqrt{n\ell})$ [26, 29, 30]. By finding such a
 118 separator and trying every possible coloring on the disks of the separator, we can branch into
 119 $\ell^{O(\sqrt{n\ell})}$ smaller instances (here it is convenient to generalize the problem into the list coloring
 120 problem, where certain colors are forbidden on certain disks). This recursive procedure has
 121 the running time claimed in Theorem 1. We can use higher-dimensional separation theorems
 122 and a similar approach to prove the upper bound of Theorem 3. This part is explained in
 123 detail in Section 2.

124 For the lower bound of Theorem 1, the first observation is that instances with the
 125 following structure seem to be the hardest: the set of disks consists of g^2 groups forming a
 126 $g \times g$ -grid and each group consists of ℓ pairwise intersecting disks such that disks in group
 127 (i, j) can intersect disks only from those other groups that are adjacent to (i, j) in the $g \times g$ -
 128 grid. Note that this instance has $n = g^2\ell$ disks. As a sanity check, let us observe that
 129 the $g\ell$ disks in any given row have $\ell^{g\ell}$ possible different colorings, hence we can solve the
 130 problem by a dynamic programming algorithm that sweeps the instance row by row in time
 131 in $2^{O(g\ell \log \ell)} = 2^{O(\sqrt{n\ell} \log \ell)}$, which is consistent with the upper bound of Theorem 1. We
 132 introduce the PARTIAL d -GRID COLORING problem as a slight generalization of such grid-like
 133 instances where some of the $g \times g$ groups can be missing, see Figure 1 for an illustration.

134 To prove that instances of this form cannot be solved significantly faster, we reduce
 135 from a restricted version of satisfiability where g^2k variables are partitioned into g^2 groups of
 136 size k each such that these groups form a $g \times g$ -grid and there are two types of constraints:
 137 clauses of size at most 3 where each variable comes from the same group and equality
 138 constraints forcing two variables from two adjacent groups to be equal. It is not very
 139 difficult to show that any 3-SAT instance with $O(gk)$ variables and $O(gk)$ clauses can be
 140 embedded into such a problem, hence the ETH implies that the problem cannot be solved in

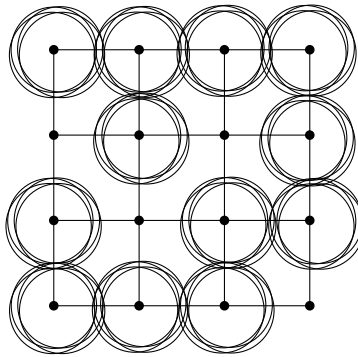

Figure 1: A grid of disks.

141 time $2^{o(gk)}$. We reduce such instances of 3-SAT to the coloring problem by representing each
 142 group of k variables with a group of $\ell = O(k)$ disks and make the following correspondence
 143 between truth assignments and colorings: if the i -th variable of the group is true, then we
 144 represent it by giving color $2i - 1$ to the $(2i - 1)$ -st disk and color $2i$ to the $2i$ -th disk, and
 145 we represent false by swapping these two colors. Then we implement gadgets that enforce
 146 the meaning of the clauses and the equality constraints. This way, we create an equivalent
 147 instance with $O(g^2)$ groups of $\ell = O(k)$ disks in each group, hence an algorithm with running
 148 time $2^{o(g\ell)} = 2^{o(gk)}$ would violate ETH, which is what we wanted to show.

149 A technical issue that arises in the reduction is that we want to consistently assign the
 150 same meaning to the colors everywhere throughout the created instance (e.g., in each group,
 151 we want to use colors $\{2i - 1, 2i\}$ on the $(2i - 1)$ -st and $2i$ -th disks of the group). This would
 152 be easy to do in the more general list coloring version of the problem where it is possible
 153 to distinguish colors using the lists. However, the colors are completely interchangeable in
 154 the ordinary coloring problem, for example, we can arbitrarily permute the colors in any
 155 proper coloring. An obvious approach is to use one of the groups as reference and define the
 156 color appearing on the i -th disk of the group to be interpreted as the i -th color. Then the
 157 challenge is to propagate this reference coloring to each and every gadget of the constructed
 158 instance. This may seem impossible at first: the “wires” propagating the reference coloring
 159 would need to cross the “wires” propagating streams of information between the gadgets. We
 160 get around this problem by splitting the reference coloring into two halves and propagating
 161 them separately.

162 The d -dimensional lower bound of Theorem 3 goes along the same lines, but we
 163 first prove a lower bound for a d -dimensional version of 3-SAT, where there are g^d groups
 164 of variables of size k each, arranged into a $g \times \dots \times g$ -grid. Based on earlier results by
 165 Marx and Sidiropoulos [24], we prove an almost tight lower bound for this d -dimensional
 166 3-SAT by embedding a 3-SAT instance with roughly $g^{d-1}k$ variables and clauses into the
 167 d -dimensional $g \times \dots \times g$ -grid. Then the reduction from this problem to coloring unit balls
 168 in d -dimensional space is very similar to the 2-dimensional case.

169 **2 Algorithms**

170 The *ply* (also called *thickness*) of a family of sets is the maximum number of sets that cover
 171 a single point. Fix $d \geq 2$ and let \mathcal{S} be a family of n d -dimensional convex objects. Note
 172 that the ply of \mathcal{S} is at most the chromatic number of the intersection graph of \mathcal{S} . Indeed,
 173 the subfamily of objects covering a same point forms a clique.

The *diameter* of a geometric object S is the supremum of the distance between any pair of points of S . The *width* of S is the infimum of distances between two parallel hyperplanes H_1, H_2 , such that S lies between H_1 and H_2 . A family \mathcal{S} of geometric objects is *B-fat* if for each $S \in \mathcal{S}$ it holds that

$$\frac{\text{diameter}(S)}{\text{width}(S)} \leq B.$$

174 The theorem below is a special case of Theorem 26 in the manuscript of Smith and
 175 Wormald [29], which was informally announced in the extended abstract presented at FOCS
 176 1998 [30].

177 **Theorem 4** (Smith, Wormald [29]). *For every $d \geq 1$ and $B \geq 0$, there exists a constant*
 178 *$c = c(d, B)$, such that for every B -fat collection \mathcal{S} of n d -dimensional convex sets with ply*
 179 *at most ℓ , there exists a d -dimensional sphere Q , such that:*

- 180 (i) *at most $\frac{d+1}{d+2} n$ elements of \mathcal{S} are entirely inside Q ,*
- 181 (ii) *at most $\frac{d+1}{d+2} n$ elements of \mathcal{S} are entirely outside Q ,*
- 182 (iii) *at most $cn^{1-1/d}\ell^{1/d}$ elements of \mathcal{S} intersect Q .*

183 Now, using a fairly standard divide-and-conquer approach we prove the main result
 184 of this section, which implies the upper bounds in Theorems 1 and 3.

185 **Theorem 5.** *Let G be an intersection graph of a B -fat collection $\mathcal{S} = \{S_1, S_2, \dots, S_n\}$ of*
 186 *n d -dimensional convex objects. For any integer $\ell \leq n$ and lists $L: \mathcal{S} \rightarrow 2^{[\ell]}$, we can decide*
 187 *whether G can be properly colored with lists L in time $n^{O(n^{1-1/d}\ell^{1/d})} = 2^{O(n^{1-1/d}\ell^{1/d} \log n)}$,*
 188 *using polynomial space.*

Proof. First, we will exhaustively check if G contains an $(\ell + 1)$ -clique. If so, we can immediately terminate, as ℓ colors are clearly not sufficient to color G . We can do it in time:

$$n^{\ell+1} \cdot n^{O(1)} = n^\ell \cdot n^{O(1)} = 2^{\ell \log n} \cdot n^{O(1)} = 2^{O(n^{1-1/d}\ell^{1/d} \log \ell)}.$$

189 Indeed, $\ell \log n \leq n^{1-1/d}\ell^{1/d} \log \ell$ is equivalent to $\ell^{1-1/d}/\log \ell \leq n^{1-1/d}/\log n$; which holds when
 190 n is sufficiently large ($n \geq 8$) since $\ell \leq n$ and $x \rightarrow x^{1-1/d}/\log x$ is increasing for $x \geq 8$.

191 From now on, we can assume that there is no $(\ell + 1)$ -clique in G and thus the ply of
 192 \mathcal{S} is at most ℓ . By Theorem 4, there exists a set $Q \subseteq \mathcal{S}$ of at most $cn^{1-1/d}\ell^{1/d}$ objects (or,
 193 equivalently, a subset of vertices of G) such that $\mathcal{S} \setminus Q$ is split into two parts $\mathcal{S}_1, \mathcal{S}_2$, each of
 194 size at most $\frac{d+1}{d+2} n$ and such that no object of \mathcal{S}_1 intersects an object of \mathcal{S}_2 .

We can find such a set in an exhaustive way in time:

$$n^{cn^{1-1/d}\ell^{1/d}} \cdot n^{O(1)} = 2^{O(n^{1-1/d}\ell^{1/d}\log n)}.$$

Now, for every coloring of Q with lists L , we can try to extend this coloring to \mathcal{S}_1 and \mathcal{S}_2 recursively, using the standard divide-and-conquer approach (note that the lists of objects in $\mathcal{S} \setminus Q$ are updated according to the coloring of Q). This gives us the total running time

$$T(n) \leq 2^{O(n^{1-1/d}\ell^{1/d}\log \ell)} \cdot 2 T\left(\frac{d+1}{d+2} n\right).$$

195 Solving this recursion we obtain the running time $2^{O(n^{1-1/d}\ell^{1/d}\log \ell)}$.

196 Thus, the total running time of the algorithm is $2^{O(n^{1-1/d}\ell^{1/d}\log n)}$. Observe that the
197 space used is polynomial. \square

198 Since finding a proper geometric representation of many types of intersection graphs
199 is NP-hard [32] (or even $\exists\mathbb{R}$ -hard [3]), we are often interested in designing *robust algorithms*.
200 An algorithm is robust if its input is a graph (without a geometric representation), and the
201 algorithm either gives a correct answer, or reports that the input graph is not an intersection
202 graph.

203 We point out that the above coloring procedure is robust. If G is not an intersection
204 graph of fat convex objects, then the algorithm either gives the correct answer (if G happens
205 to have appropriate separators), or we can correctly report that the input is invalid (the
206 exhaustive search step fails to find any separator).

207 Note that the running time could be slightly improved to $2^{O(n^{1-1/d}\ell^{1/d}\log \ell)}$ should
208 we have a faster algorithm for finding separators. It is worth noting that such (polynomial)
209 algorithms exist for d -dimensional balls, cubes, and many other shapes [26, 30]. In particular,
210 we obtain the following result for disks in a plane.

211 **Corollary 6.** *Given a set \mathcal{S} of n disks in the plane, the existence of a ℓ -coloring of an*
212 *intersection graph of \mathcal{S} can be decided in time $2^{O(\sqrt{n\ell}\log \ell)}$, using polynomial space.*

213 3 Intermediate problems

214 In this section, we introduce two technical problems, which will serve as an intermediate
215 step in our hardness reductions. Let us start with some notation and definitions. For an
216 integer n , we denote by $[n]$ the set $\{1, 2, \dots, n\}$. For a set S , we denote by 2^S the family
217 of all subsets of S . For a fixed dimension d and $i \in [d]$, we denote by e_i the d -dimensional
218 vector, whose i -th coordinate is equal to 1 and all remaining coordinates are equal to 0. For
219 a point $p \in \mathbb{N}^d$ and $i \in [d]$, by $p[i]$ we denote the i -th coordinate of p , i.e. $p \cdot e_i$, where ‘ \cdot ’
220 denotes the inner product of vectors. For two positive integers g, d , we denote by $R[g, d]$ the
221 d -dimensional g -grid, i.e., a graph whose vertices are all vectors from $[g]^d$, and two vertices
222 are adjacent if they differ on exactly one coordinate, and exactly by one (on that coordinate).
223 In other words, a and a' are adjacent if $a = a' \pm e_i$ for some $i \in [d]$.

224 We will often refer to vertices of a grid as *cells*. Moreover, if the value of g is either
 225 clear from the context or unimportant, we will call $R[g, d]$ simply a d -dimensional grid.

226 The first problem is called d -GRID 3-SAT and can be seen as a 3-SAT embedded in
 227 a grid.

Problem: d -GRID 3-SAT

Input: A d -dimensional grid $G = R[g, d]$, a positive integer k , a function $\zeta : v \in V(G) \mapsto \{v_1, v_2, \dots, v_k\}$ mapping each cell v to k fresh boolean variables, and a set \mathcal{C} of constraints of two kinds:

clause constraints: for a cell v , a set $\mathcal{C}(v)$ of pairwise variable-disjoint disjunctions of at most 3 literals on $\zeta(v)$;

equality constraints: for adjacent cells v and w , a set $\mathcal{C}(v, w)$ of pairwise variable-disjoint constraints of the form $v_i = w_j$ (with $i, j \in [k]$).

Question: Is there an assignment of the variables such that all constraints are satisfied?

228 Not all variables need to appear in some constraint.

229 The second technical problem is called PARTIAL d -GRID COLORING.

Problem: PARTIAL d -GRID COLORING

Input: An induced subgraph G of the d -dimensional grid $R[g, d]$, a positive integer ℓ , and a function $\rho : v \in V(G) \mapsto \{p_1^v, p_2^v, \dots, p_\ell^v\} \in ([\ell]^d)^\ell$ mapping each cell v to a set of ℓ points in $[\ell]^d$. It is possible that some points p_i^v and p_j^v are superimposed, i.e., they have exactly the same coordinates – they are still counted as different points.

Question: Is there an ℓ -coloring of all the points such that:

- two points in the same cell get different colors;
- if v and w are adjacent in G with $w = v + e_i$ (for some $i \in [d]$), and $p \in \rho(v)$ and $q \in \rho(w)$ receive the same color, then $p[i] \leq q[i]$?

230 The above definition is fairly technical but its underlying idea is simple. Let us first
 231 think of PARTIAL 2-GRID COLORING, the case when $d = 2$. We want to see a grid of unit
 232 disks (see Figure 1) as the centers of the disks in a discretized and normalized space (say,
 233 *inner grids*) where adjacencies between two contiguous cells (of the *outer grid*) is determined
 234 by exactly one coordinate within the inner grids. The forthcoming Section 4.1 and Figure 2
 235 show the direct correspondence between a grid of unit disks and an instance of PARTIAL
 236 2-GRID COLORING.

237 4 Two-Dimensional Lower Bounds

238 In this section, we discuss how to obtain a lower bound for the complexity of coloring unit
 239 disk graphs. We do it using a three-step reduction and the intermediate problems introduced
 240 in the previous section. Thanks to introducing these two intermediate steps, our construction
 241 is easy to generalize to higher dimensions (see Section 5).

242 We start with the last step of the reduction chain as it is the most direct. Furthermore
 243 it explains and motivates the introduction of PARTIAL d -GRID COLORING, or rather here
 244 PARTIAL 2-GRID COLORING, its special case in dimension 2. We will use the following
 245 theorem, whose proof can be found in Section 4.3.

246 **Theorem 8.** *For any $0 \leq \alpha \leq 1$, there is no $2^{o(\sqrt{n\ell})}$ algorithm solving PARTIAL 2-GRID
 247 COLORING on a total of n points and $\ell = \Theta(n^\alpha)$ points in each cell (that is n/ℓ cells), unless
 248 the ETH fails.*

249 4.1 Reduction from Partial 2-grid Coloring to ℓ -Coloring of unit disk graphs

250 *Proof of the third and last step of the lower bound of Theorem 1.* There is a transparent re-
 251 duction from PARTIAL 2-GRID COLORING to ℓ -COLORING on unit disk graphs. We follow,
 252 for instance, Theorems 1 and 3 in [22]. In that paper, a reduction is given from a problem
 253 called GRID TILING to INDEPENDENT SET on unit disk graphs. The same reduction applies
 254 from PARTIAL 2-GRID COLORING, which can be seen as a coloring variant of GRID TILING,
 255 to ℓ -COLORING on unit disk graphs.

256 Consider an instance of PARTIAL 2-GRID COLORING with n points in total, whose
 257 points are in $[\ell]^2$ in each cell. One turns every point $(x, y) \in [\ell]^2$ of every cell at position
 258 (i, j) into a disk centered at $((2\ell^2 + 0.1)i + x, (2\ell^2 + 0.1)j + y)$. The common radius of all
 259 the disks is set to ℓ^2 , and we set the number of colors to ℓ (see Figure 2). This way, the fact
 260 that two disks coming from adjacent cells along the x -axis (resp. y -axis) intersect is only
 261 determined by their x -coordinate (resp. y -coordinate). Indeed, the disks are big enough
 262 compared to the cells containing the points so that in the region where the disks of adjacent
 263 cells may intersect, their boundaries are close to horizontal or vertical straight lines (see the
 264 red rectangle in Figure 2). A formal explanation is detailed in Theorem 14.34 of [6]. Now
 265 Theorem 1 follows directly from Theorem 8. \square

266 **Remark 1.** *Note that we do not actually require that the relation of the number n of disks
 267 and the number ℓ of colors is $\ell = \Theta(n^\alpha)$ for some α . The claim holds also for other functions
 268 $\ell = \ell(n) = O(n)$, e.g. $\ell = \Theta(\log n)$.*

269 Then we detail the first step of the reduction chain.

270 4.2 Reduction from 3-Sat to 2-grid 3-Sat

271 **Theorem 7.** *For any $0 \leq \alpha \leq 1$ there is no algorithm solving 2-GRID 3-SAT with n variables
 272 in total and $k = \Theta(n^\alpha)$ variables per cell in time $2^{o(\sqrt{nk})} = 2^{o\left(n^{\frac{1+\alpha}{2}}\right)}$, unless the ETH fails.*

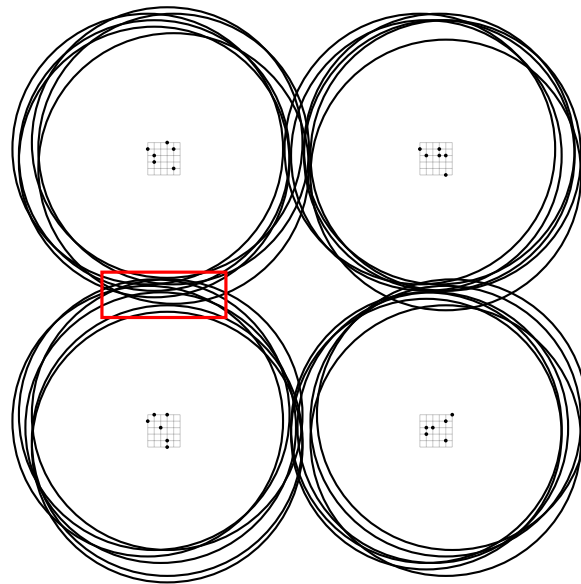

Figure 2: Illustration of how the disks are spaced out. In the region marked by the red rectangle, where disks of two adjacent cells may intersect, the boundary of each disk is close to a horizontal straight line. So, two disks do *not* intersect if and only if the y -coordinate of the center in the top cell is at most the y -coordinate of the center in the bottom cell.

273 *Proof.* The ETH together with the Sparsification Lemma [19] implies that there is no
 274 $2^{o(N+M)}$ algorithm to decide satisfiability of a 3-SAT formula with N variables and M
 275 clauses.

276 Let Φ be a 3-SAT formula with the variable set Var and the clause set \mathcal{C} . There
 277 is a simple polynomial-time procedure to modify Φ so that each variable appears at most
 278 3 times. Indeed, first note that we can assume that no variable appears more than once
 279 within a clause. For each variable v appearing $\Delta > 3$ times, we introduce Δ new variables
 280 $v_1, v_2, \dots, v_\Delta$ and substitute each appearance of v with a different v_i . We also add clauses
 281 $(v_1 \vee \neg v_2), (v_2 \vee \neg v_3), \dots, (v_{\Delta-1} \vee \neg v_\Delta), (v_\Delta \vee \neg v_1)$ to \mathcal{C} . This chain of clauses enforces
 282 that all v_i 's have the same truth-value in any satisfying assignment. Note that each newly
 283 introduced variable has exactly 3 occurrences. We repeat this until there are no variables
 284 with more than 3 occurrences. Thus we introduced at most $3|\mathcal{C}|$ new variables and $3|\mathcal{C}|$
 285 new clauses. So we can assume that each variable of Φ appears at most three times, let
 286 $N := |Var|$ and $M := |\mathcal{C}|$. Clearly $M = \Theta(N)$.

287 We choose $k = \Theta(N^{2\alpha/(1+\alpha)})$ (actual constants will follow from the description
 288 below). Now we want to cover the set of variables by $g = 7 \lceil 6M/k \rceil = \Theta(k^{(1-\alpha)/2\alpha})$ groups
 289 $\mathcal{V}_1, \dots, \mathcal{V}_g$ such that the following conditions hold:

- 290 • for each clause C , there exists a group \mathcal{V}_i , such that all variables of C belong to \mathcal{V}_i ;
 291 we say this group contains the clause C ;
- 292 • if two clauses C, C' share a variable, then they are contained in different groups;

- each group contains at most $k/2$ variables.

To form these groups, we first construct a partition \mathcal{P}_0 of the clauses into $g' = g/7 = \lceil 6M/k \rceil$ groups of size at most $\lfloor M/g' \rfloor \leq k/6$. As each variable occurs in at most three clauses, and thus every clause shares some variable with at most six other clauses, we can easily define a second refined partition \mathcal{P}_1 of the clauses into $g = 7g'$ groups, such that no two clauses that share a variable are contained in the same group. We denote these groups by $\mathcal{C}_1, \dots, \mathcal{C}_g$. Now, we set \mathcal{V}_i to be exactly the set of variables contained in the set of clauses \mathcal{C}_i . As each clause has at most three variables, each group \mathcal{V}_i contains at most $3 \cdot k/6 = k/2$ variables. Now, we construct an instance $I(\Phi)$ of 2-GRID 3-SAT. Let $G = R[g, 2]$ with k variables in

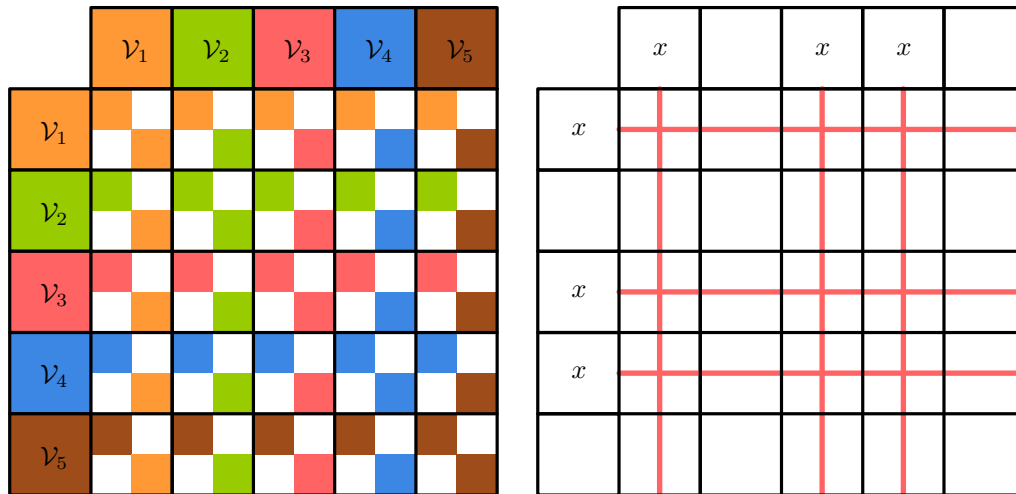

Figure 3: Allocation of the variables. Each color corresponds to a set of variables. Note that for any variable x , the set of cells containing x is connected.

each cell. Note that the number of variables in $I(\Phi)$ is $g^2k = \Theta(k^{1/\alpha})$.

The cell (i, j) should contain the information about truth assignment of $\mathcal{V}_i \cup \mathcal{V}_j$. Note that if a variable appears in both \mathcal{V}_i and \mathcal{V}_j , it will be represented just once in the cell (i, j) . As each group \mathcal{V}_i contains at most $k/2$ variables, each cell has enough space to accommodate all this information. To make all cells contain exactly k variables, we can add some dummy variables, which will not appear in any constraints. The total number of dummy variables added is at most $g^2 \cdot k$, so the total number n of variables is $\Theta(k^{1/\alpha})$. Observe that the variable group \mathcal{V}_i is contained exactly in the i -th row and i -th column of G . Now, we add each clause $C \in \mathcal{C}_i$ to the set of clause constraints of the cell (i, i) . Finally, we need to make sure that all copies of a single variable have the same truth assignment. Observe that for each variable x the cells containing x form a connected set (see Fig. 3). Therefore the consistency can be ensured using equality constraints. Note that since no variable appears more than once in a single cell, the equality constraints related to each edge of G are variable-disjoint.

It is easy to see that Φ is satisfiable if and only if $I(\Phi)$ is satisfiable. Furthermore $N = O(gk) = O(\sqrt{g^2k^2}) = O(\sqrt{nk})$. This implies that a $2^{O(\sqrt{nk})}$ algorithm for 2-GRID 3-SAT refutes the ETH. \square

319 4.3 Reduction from 2-grid 3-Sat to Partial 2-grid Coloring

320 The next step is reducing 2-GRID 3-SAT to PARTIAL 2-GRID COLORING. This step is the
321 most important part of the proof.

322 **Theorem 8.** *For any $0 \leq \alpha \leq 1$, there is no $2^{o(\sqrt{n\ell})}$ algorithm solving PARTIAL 2-GRID
323 COLORING on a total of n points and $\ell = \Theta(n^\alpha)$ points in each cell (that is n/ℓ cells), unless
324 the ETH fails.*

325 *Proof.* We present a reduction from 2-GRID 3-SAT to PARTIAL 2-GRID COLORING. Let
326 $I = (G, k, \zeta, \mathcal{C})$ be an instance of 2-GRID 3-SAT, where $G = R[g, 2]$ and each cell contains
327 k variables. We think of G as embedded in the plane in a natural way, with edges being
328 horizontal or vertical segments. We construct an equivalent instance $J = (F, \ell, \rho)$ of PARTIAL
329 2-GRID COLORING with $|V(F)| = \Theta(|V(G)|) = \Theta(g^2)$ and $\ell := 4k$ points per cell, where F
330 is an induced subgraph of $R[g', 2]$ with $g' = \Theta(g)$.

331 First, we will explain the most basic building blocks of our construction, i.e., standard
332 cells, reference cell, variable-assignment cells, local reference cells, and wires. Then we are
333 ready to give an overview of the whole reduction. We finish with an elaborate explanation
334 of more complicated gadgets and proof of their correctness.

335 **Standard cells.** A *standard cell* is a cell where the points p_1, \dots, p_ℓ are on the main
336 diagonal, that is $p_i = (i, i)$ for every $i \in [\ell]$ (see cells A and B of Figure 5a). When we
337 talk about the ordering of the points in a standard cell, we always mean the left-to-right (or
338 equivalently, top-to-bottom) ordering. Standard cells will be used for the basic pieces of the
339 construction, i.e., variable-assignment cells, local reference cells, and wires (see below).

340 **Reference coloring.** Later in the construction we will choose one standard cell \bar{R} , which
341 will be given a special function. We will refer to the coloring of \bar{R} as the *reference coloring*.
342 For each $i \in [\ell]$, we define the color i to be the color used for the point p_i in \bar{R} . Now, saying
343 that a point somewhere else has color i , has an absolute meaning; it means using the same
344 color as used for point p_i in \bar{R} .

345 **Variable-assignment cells.** For each cell $v = (i, j) \in V(G)$, we introduce in F a standard
346 cell $A(v) = (\delta i, \delta j)$, where δ is a large constant (the coordinates of cells refer to their position
347 in $R[g', 2]$, which is a supergraph of F). The cells $A(v)$ for $v \in V(G)$ are responsible
348 for encoding the truth assignment of variables in $\zeta(v)$. Therefore we call them *variable-*
349 *assignment cells*. We will partition variable-assignment cells into two types. The cell $A(v)$
350 for $v = (i, j)$ of I is called *even* if $i + j$ is even. Otherwise $A(v)$ is *odd*. Note that if v and w
351 are adjacent cells in I , then $A(v)$ and $A(w)$ have different parity.

352 As each variable-assignment cell contains $\ell = 4k$ points, there are $\ell! = 2^{O(\ell \log \ell)}$
353 ways to color these points with ℓ colors. We will only make use of $2^{\ell/4} = 2^k$ colorings
354 among those. In our construction, we will make sure that each variable-assignment cell
355 receives one of the *standard colorings*. If the cell $A(v)$ is even, the coloring φ of $A(v)$ is
356 standard if $\{\varphi(p_{2i-1}), \varphi(p_{2i})\} = \{2i-1, 2i\}$ for $i \in [k]$ and $\varphi(p_i) = i$ for $i \in [4k] \setminus [2k]$. If
357 the cell $A(v)$ is odd, its standard colorings φ are the ones with $\varphi(p_i) = i$ for $i \in [2k]$ and
358 $\{\varphi(p_{2i-1}), \varphi(p_{2i})\} = \{2i-1, 2i\}$ for $i \in [2k] \setminus [k]$. The choice of the particular standard
359 coloring for the points in $A(v)$ defines the actual assignment of variables in $\zeta(v)$. If $A(v)$ is

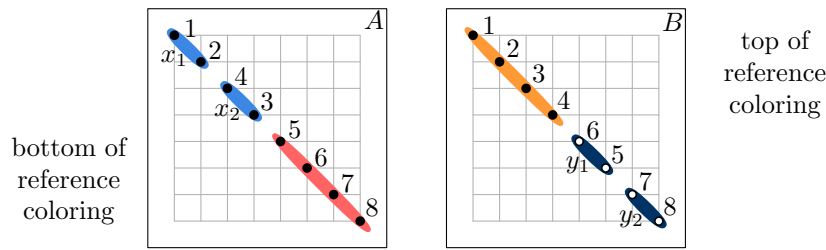

Figure 4: Variable-assignment cells of even parity contain the bottom half of the reference coloring as in cell A and cells of odd parity contain the top part of the reference coloring, as in cell B .

360 even, then for each $i \in [k]$, we interpret the coloring in the following way:

361
$$p_{2i-1} \mapsto 2i - 1, p_{2i} \mapsto 2i \text{ as setting the variable } v_i \text{ to true;}$$

362
$$p_{2i-1} \mapsto 2i, p_{2i} \mapsto 2i - 1 \text{ as setting the variable } v_i \text{ to false.}$$

363 If $A(v)$ is odd, for each $i \in [k]$, we interpret it in that way:

364
$$p_{2k+2i-1} \mapsto 2i - 1, p_{2k+2i} \mapsto 2i \text{ as setting the variable } v_i \text{ to true;}$$

365
$$p_{2k+2i-1} \mapsto 2i, p_{2k+2i} \mapsto 2i - 1 \text{ as setting the variable } v_i \text{ to false.}$$

366 Observe that in even (odd, respectively) cells $A(v)$ the assignment of variables is
 367 only encoded by the coloring of the first (last, respectively) $2k$ points in $A(v)$. The colors of
 368 the remaining points are exactly the same as in the reference coloring, so each cell contains
 369 exactly one half of the reference coloring.

370 **Local reference cells.** For all $i, j \in [g - 1]$, we introduce a new standard cell $R(i, j) :=$
 371 $(\delta i + \delta/2, \delta j + \delta/2)$, called a *local reference cell*. Moreover, we set the reference \bar{R} to be
 372 $R(1, 1)$. In the construction, we will ensure that the coloring of each local reference cell is
 373 exactly the same, i.e., is exactly the reference coloring.

374 Consider the variable-assignment cell $A(v)$ for $v = (i, j)$. We say that a local reference
 375 cell $R(i', j')$ is associated with $A(v)$, if $j - j' \in \{0, 1\}$ and $i - i' \in \{0, 1\}$. Note that each
 376 variable-assignment cell has one, two, or four associated local reference cells. Moreover, if
 377 v, w are adjacent cells of I , then $A(v)$ and $A(w)$ share at least one associated local reference
 378 cell.

379 **Wires.** If two standard cells are adjacent, then they must be colored in the same way;
 380 thus having a path of standard cells, allows us to transport the information from one cell to
 381 another. Let us prove that claim. Let A and B be two adjacent standard cells, such that A
 382 is left of B (see Figure 5a; the argument is similar if the cells are vertically adjacent).

383 Let p_1, \dots, p_ℓ be the points of the cell A and q_1, \dots, q_ℓ be the points of the cell B .
 384 Note that the color of q_1 is necessarily equal to the color of p_1 , because the x -coordinates
 385 of points p_2, p_3, \dots, p_ℓ exceed the x -coordinate of q_1 . Inductively, we can show that for
 386 every $i \geq 2$, the color of q_i is the same as the color of p_i . Indeed, the colors used for
 387 $p_{i+1}, p_{i+2}, \dots, p_\ell$ are not available for q_i , because these points are too close to q_i . On the

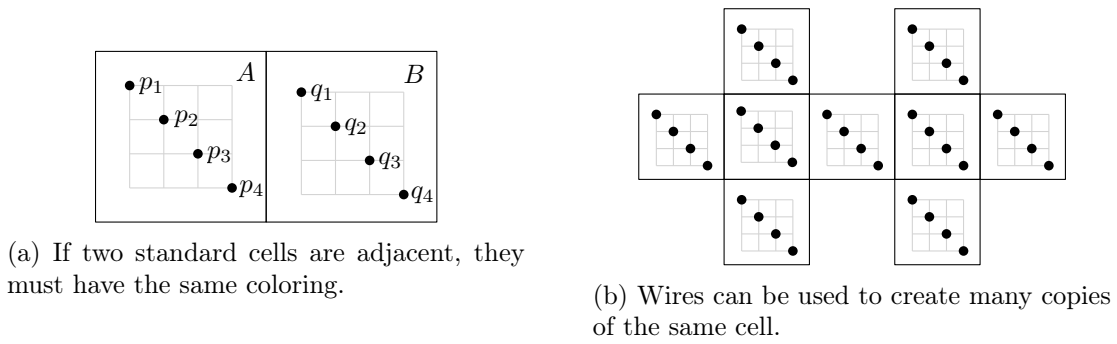

Figure 5: Construction and usage of wires.

388 other hand, by the inductive assumption, all colors used on p_1, p_2, \dots, p_{i-1} are already used
 389 for points q_1, q_2, \dots, q_{i-1} . Thus the only possible choice for the color of q_i is the color of p_i .

390 Observe that the use of wires allows us to create many copies of the same cell (see
 391 Fig. 5b). We say two cells are the same, if the point configuration and their coloring must
 392 be necessarily the same.

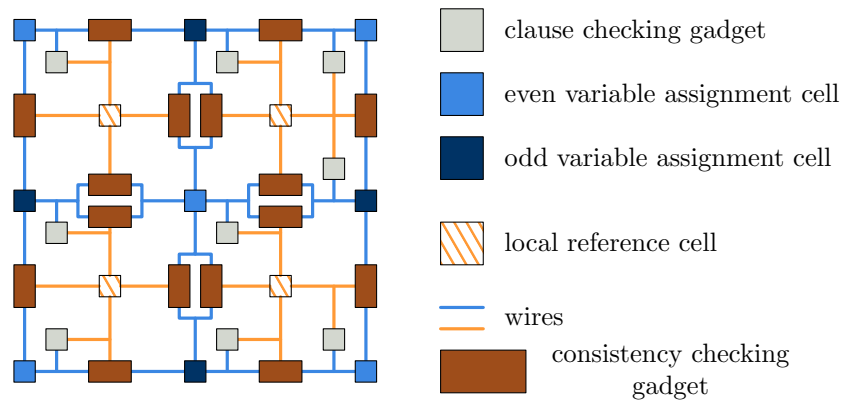

Figure 6: Illustration of the instance J . Each blue square represents a cell $A(v)$ corresponding to the cell v of I (light blue cells represent even cells and dark blue ones represent odd cells). The orange squares are local reference cells, which contain the reference coloring. Gray and brown squares represent, respectively, clause-checking and consistency gadgets.

393 **Overview of the construction** Before we move on to describe more complicated gadgets,
 394 we explain the overview of the construction. Figure 6 presents the arrangement of the cells
 395 in F . For each variable-assignment cell $A(v)$, we introduce a *clause-checking gadget*, which
 396 is responsible for ensuring that all clauses in $\mathcal{C}(v)$ are satisfied. This gadget requires an
 397 access to the reference coloring, which can be attained from the local reference cells (we can
 398 choose any of the local reference cells associated with $A(v)$). For each edge vw of G , we
 399 introduce a *consistency gadget*. In fact, for inner edges of G (i.e., the ones not incident with
 400 the outer face²) we introduce two consistency gadgets, one for each face incident with vw .

²by a face we mean a region of the plane bounded by edges of G

401 This gadget is responsible for ensuring the consistency on three different levels:

- 402 • to force all equality constraints $\mathcal{C}(v, w)$ to be satisfied,
- 403 • to ensure that each of $A(v)$ and $A(w)$ receives one of the standard colorings,
- 404 • to ensure that the local reference cell contains exactly the reference coloring.

405 This gadget also requires access to the reference coloring, so we join it with the appropriate
406 local reference cell (see Fig. 6).

407 To join the variable-assignment cells and local reference cells with appropriate gad-
408 gets, we will use wires. Notice that each cell A can interact with at most four other cells,
409 which may not be enough, if we want to attach several gadgets to A (see e.g. the middle
410 variable assignment cell in Figure 6). However, since wires allow us to create an exact copy
411 of A , we can attach any constant number of gadgets to copies of A , adding only a constant
412 number of additional cells. Moreover, we can do it in a way that ensures that no two gad-
413 gets interact with each other (anywhere but on A). Thus, when we say that we attach some
414 gadget to a cell, we will not discuss how exactly we do this.

415 Every gadget uses only a constant number of cells. Thus, making the constant δ
416 large enough and using wires, we can make sure that different gadgets do not interact with
417 each other (except for the shared cells). The total number of points in the construction is
418 clearly increased only by a constant factor.

419 **Permuting points and colors.** Recall that when describing wires, we have not used the
420 second coordinate of the points p_1, \dots, p_ℓ and q_1, \dots, q_ℓ . In fact, those coordinates can be
421 chosen at our convenience, and the argument supporting the claim in the paragraphs on
422 the wires would still work. Combining this observation horizontally and vertically, we can
423 force any permutation of the colors (see Figure 7a). The gadget is realized as follows. Let
424 σ be our target permutation. To the right of a standard cell A , we put a cell B . For each
425 $i \in [\ell]$, we add a point $(i, \sigma(i))$ to B , so there are ℓ points in total. Below the cell B , we put
426 a standard cell C . We observe that in any feasible coloring of those three cells, for every
427 $i \in [\ell]$, the points p_i and $q_{\sigma(i)}$ have the same color, where p_i (resp. q_i) is the point in (i, i)
428 in the cell A (resp. cell C). Although permutation gadgets are more complicated than wires,
429 the formal argument of correctness is identical as in the case of wires, as the propagation of
430 colors between neighboring cells depends on only one coordinate.

431 **Forgetting color assignment.** Besides permuting points and colors, it is also possible to
432 forget the color assignment of some points. Figure 7b shows a forgetting gadget attached
433 to standard cells A and C . In the cell A we have the coloring from left to right a, b, c, d .
434 In the cell C , the first two points can be colored either a, b or b, a . In particular, if A is an
435 even variable-assignment cell, then by looking at C we cannot distinguish anymore whether
436 the variable was set to true or to false. Thus, using a forgetting gadget attached to two
437 standard cells, we may force equality of colors of some corresponding points, while giving
438 some freedom of choosing the others. This concept will be used in the next paragraph.

439 **Parallelism.** As we may have hinted in the previous paragraph, subparts of a given cell
440 can act independently. In particular, this means that we can choose to forget any subset

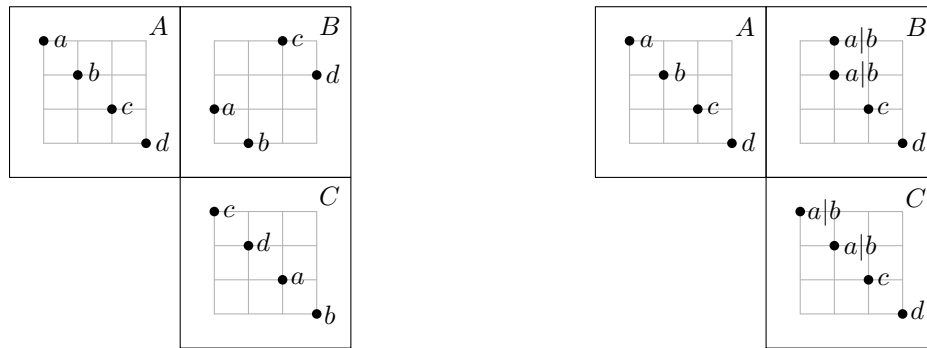

(a) The coloring of C is the coloring of A with the permutation $\sigma = (3, 4, 1, 2)$ applied.

(b) In the cell C , colors a and b are now interchangeable.

Figure 7: Permutation gadget (left) and forgetting gadget (right), attached to cells A and C .

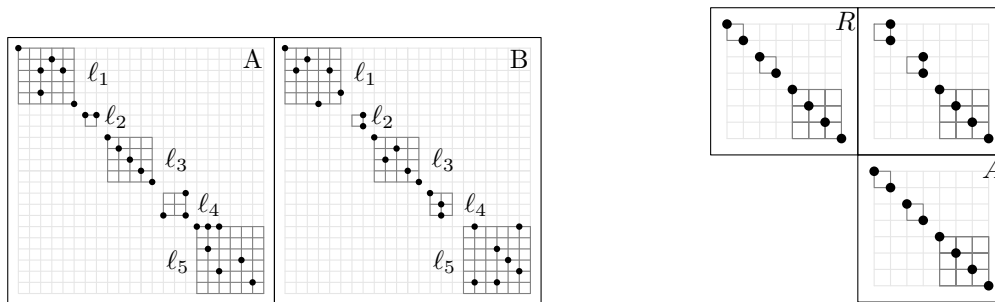

(a) The sets of colors used within corresponding boxes of A and B are equal.

(b) If R contains the reference coloring, then A receives one of standard colorings (for an even cell).

Figure 8: Boxes in adjacent cells with the same box-structure act independently from each other.

441 of information but preserve the rest. It is important to note that this is a more general
 442 phenomenon. Let ℓ_1, \dots, ℓ_t be positive integers summing up to ℓ . Consider an arrangement
 443 of cells where the points of each cell are all contained in the same square boxes of side lengths
 444 respectively ℓ_1, \dots, ℓ_t , along the diagonal as shown in Figure 8a. For each $h \in [t]$, the h -th
 445 box (of side length ℓ_h) contains exactly ℓ_h points.

446 One may observe that a slight generalization of the argument given in the paragraph
 447 on wires shows that if A and B are adjacent cells with the same box-structure, i.e., each has
 448 points grouped in t boxes of sizes ℓ_1, \dots, ℓ_t , then for each $h \in [t]$, the set of colors used on
 449 points in h -th box in A is exactly the same as the set of colors used in h -th box in B (see
 450 Figure 8a).

451 We point out that the combination of this observation and the forgetting gadget
 452 attached to a local reference cell and a variable-assignment cell A can be used to ensure that
 453 A receives one of the standard colorings (see Fig. 8b). The construction of the forgetting

454 gadget varies depending on the parity of A . In general the gadget preserves the colors of $2k$
 455 points containing the copy of one half of the reference coloring, and allows any permutation
 456 of colors within two-element boxes representing the variables. We will use a similar approach
 to check several clauses in parallel within the same group of a constant number of cells.

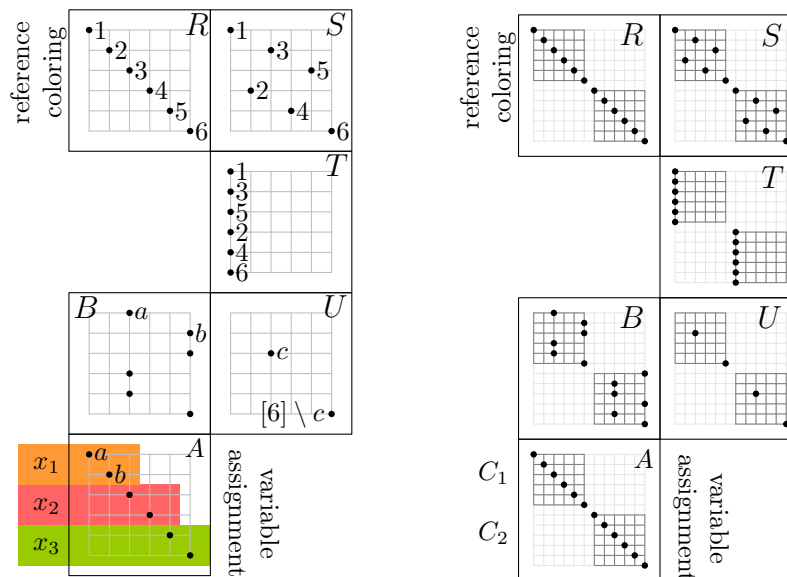

Figure 9: Illustration of the clause-checking gadget. To the left, one clause $x_1 \vee \neg x_2 \vee x_3$ is represented. To the right, two clauses are checked in parallel.

457

458 **Clause gadget.** We detail how a disjunction of three literals is encoded (see the left part of
 459 Figure 9). Clauses with fewer literals are just a simplification of what comes next. First, we
 460 will explain how to express a clause C , whose variables x_1, x_2, x_3 are contained in a (6×6) -
 461 box of a variable-assignment cell A . In the next paragraph we will show how to check several
 462 variable-disjoint clauses in one constant-size gadget. In general, in what follows, one should
 463 think of the coordinates that we will specify as coordinates within a box part of the cell,
 464 rather than as coordinates in the cell. The same applies to the colors, we should always look
 465 at the set of colors appearing in the particular box. Obviously, the clause-checking gadget
 466 needs to interact with variable-assignment encoding the values of x_1, x_2, x_3 . For simplicity of
 467 notation assume that x_1 is encoded by coloring points p_1, p_2 with colors 1, 2; x_2 is encoded by
 468 coloring points p_3, p_4 with colors 3, 4 and; x_3 is encoded by coloring points p_5, p_6 with colors
 469 5, 6. Our clause-checking gadget needs also an access to the reference coloring contained in
 470 the cell R . This is necessary to be able to distinguish between colors e.g. 1 and 2, and thus
 471 between setting x_1 to true or to false.

472 First consider cells S , T , and U . The cell R contains the reference coloring and we
 473 force the order of the colors in cell T to be from top to bottom 1, 3, 5, 2, 4, 6, similarly as we
 474 did in a permutation gadget. Consider now cell U . It has one point at position $p = (3, 3)$
 475 and 5 points superimposed at position $(6, 6)$. Now, because of cell T , the point p can only
 476 have a color $c \in \{1, 3, 5\}$. All the other colors should be given to the 5 superimposed points.

477 Then, consider cells A and B .

478 The cell A contains the variable assignment. Recall that for each variable we use two
 479 points. If a variable occupying rows $2i - 1$ and $2i$ in the cell A occurs positively in C , then
 480 we place in cell B a point in row $2i - 1$ in the third column of the box and a point in the
 481 row $2i$ in the sixth column; if the variable appears negatively, we do the opposite: we place
 482 in cell B a point in the row $2i - 1$ in the sixth column and a point in row $2i$ in the third
 483 column. Note that the colors of points in B are forced, looking from top to bottom they
 484 are the same as in A . By construction, the colors in the sixth column are not available to
 485 the point p . Therefore, the point p can be colored if and only if one of colors 1,3,5 appears
 486 in the third column of B , i.e., one of literals is true. Since the remaining points in U can
 487 receive any distinct colors, we conclude that the whole set of cells constituting the gadget
 488 can be colored if and only if the clause is satisfied by the truth assignment.

489 **Checking clauses in parallel.** Consider the cell v of 2-GRID 3-SAT. Let C_1, \dots, C_f be
 490 the clauses of $\mathcal{C}(v)$ and recall that these clauses are pairwise variable-disjoint. Let σ be a
 491 permutation of points in $A(v)$, such that the $2|C_1|$ points encoding the variables of C_1 appear
 492 on positions $1, 2, \dots, 2|C_1|$, the $2|C_1|$ points encoding the variables of C_2 appear on positions
 493 $2|C_1| + 1, 2|C_1| + 2, \dots, 2|C_1| + 2|C_2|$ and so on. The points encoding variables which do not
 494 appear in any clause from $\mathcal{C}(v)$ and the points which do not encode any variable (i.e., the
 495 points carrying a half of the reference coloring) appear on the last position, in any order.

496 We introduce a new standard cell A , and using a permutation gadget we ensure that
 497 it contains the copies of points of $A(v)$ in the permutation σ . In the same way we introduce
 498 a standard cell R , which contains the reference coloring with the permutation σ applied.
 499 An illustration on how two clauses can be checked simultaneously is shown on the right
 500 part of Figure 9. Observe that since the clauses in $\mathcal{C}(v)$ are pairwise variable-disjoint, one
 501 clause-checking gadget is enough to ensure the satisfiability of all clauses in $\mathcal{C}(v)$.

502 Thus, for each cell $A(v)$ and its associated local reference cell R , we introduce a
 503 clause-checking gadget corresponding to the clauses in $\mathcal{C}(v)$, and join it with $A(v)$ and R .

504 **Equality check.** Let A be a cell of J and let the points p_{2i-1}, p_{2i} (p_{2j-1}, p_{2j} for $2i <$
 505 $2j - 1$) in the cell A encode the variable x (y , respectively). Suppose we want to make
 506 sure that always $x = y$. This is equivalent to saying that in any proper coloring φ , we have
 507 $\varphi(p_{2i-1}) + 1 = \varphi(p_{2i})$ whenever $\varphi(p_{2j-1}) + 1 = \varphi(p_{2j})$.

508 Such an equivalence of two variables can be expressed by two clauses $C_1 = x \vee \neg y$
 509 and $C_2 = \neg x \vee y$. Thus, if we have an access to the reference coloring, we can ensure
 510 the equivalence using the clause-checking gadget. Observe that C_1 and C_2 are not variable-
 511 disjoint, so in fact we need to use two clause-checking gadgets. However, two clause-checking
 512 gadgets are enough to ensure the equivalence of any set of pairwise-disjoint pairs of variables
 513 represented in the single cell. Observe that A does not have to be a variable-assignment cell
 514 (i.e., does not have to carry a half of the reference coloring). In fact, we will use the equality
 515 checks for cells where each pair of points p_{2i-1}, p_{2i} corresponds to some variable, encoded in
 516 an analogous way as in variable-assignment cells.

517 **Consistency gadget.** The last gadget, called the consistency gadget, will join every three
 518 cells $A(v), A(w), R$, where $A(v)$ and $A(w)$ are variable-assignment cells corresponding to

519 adjacent cells v and w of I , and a R is a local reference cell associated with both $A(v)$
 520 and $A(w)$. This gadget is responsible for ensuring that colorings of these three cells are
 521 consistent, that is:

- 522 • each cell $A(v)$, $A(w)$ is colored with a standard coloring,
- 523 • the equality constraints $\mathcal{C}(v, w)$ in the 2-GRID 3-SAT instance I are satisfied,
- 524 • R has exactly the reference coloring.

525 For schematic picture of the gadget, refer to Figure 10. Suppose that $A(v)$ is even, $A(w)$ is
 526 odd, and v is above w in I (all other cases are symmetric). We denote the points of $A(v)$
 527 by p_1, p_2, \dots, p_ℓ , the points of $A(w)$ by q_1, q_2, \dots, q_ℓ , and the points by R by r_1, r_2, \dots, r_ℓ
 528 (going from top-left to bottom-right). First, we introduce two forgetting gadgets and attach
 529 one of them to R and $A(v)$, and the other one to R and $A(w)$. The first gadget forgets the
 530 top half of the reference coloring, i.e., it ensures that in every coloring φ we have

- 531 • $\{\varphi(p_{2i-1}), \varphi(p_{2i})\} = \{\varphi(r_{2i-1}), \varphi(r_{2i})\}$ for $i \in [k]$,
- 532 • $\varphi(p_{2i-1}) = \varphi(r_{2i-1})$ and $\varphi(p_{2i}) = \varphi(r_{2i})$ for $i \in [2k] \setminus [k]$.

533 The second gadget forgets the bottom half of the reference coloring, i.e., it ensures that in
 534 every coloring φ we have

- 535 • $\varphi(q_{2i-1}) = \varphi(r_{2i-1})$ and $\varphi(q_{2i}) = \varphi(r_{2i})$ for $i \in [k]$,
- 536 • $\{\varphi(q_{2i-1}), \varphi(q_{2i})\} = \{\varphi(r_{2i-1}), \varphi(r_{2i})\}$ for $i \in [2k] \setminus [k]$.

537 We also introduce a new standard cell S . Let s_1, s_2, \dots, s_ℓ be the points in S . With
 538 two additional forgetting gadgets, one attached to S and $A(v)$, and the other one attached
 539 to S and $A(w)$, we ensure that in every coloring φ we have:

- 540 • $\varphi(s_{2i-1}) = \varphi(p_{2i-1})$ and $\varphi(s_{2i}) = \varphi(p_{2i})$ for $i \in [k]$,
- 541 • $\varphi(s_{2i-1}) = \varphi(q_{2i-1})$ and $\varphi(s_{2i}) = \varphi(q_{2i})$ for $i \in [2k] \setminus [k]$.

542 Note that the cell S contains the information about the values of all variables in $\zeta(v)$ (first
 543 $2k$ points) and in $\zeta(w)$ (second $2k$ points). Now consider the set of equality constraints
 544 $\mathcal{C}(v, w)$, recall that each of them is of the form $v_i = w_j$. Thus we want to ensure that in
 545 every coloring φ , we have $\varphi(s_{2i-1}) + 1 = \varphi(s_{2i})$ if and only if $\varphi(s_{2k+2j-1}) + 1 = \varphi(s_{2k+2j})$.
 546 We can easily do it by performing the equality check on S , using two clause gadgets and R
 547 as a reference coloring.

548 It is straightforward to observe that if I is satisfiable, then J can be colored with ℓ
 549 colors, in a way described above. The opposite implication follows from the claims below.

550 **Claim 1.** The coloring of each $R(i, j)$ for $i, j \in [g - 1]$ is exactly the same as the coloring
 551 of $\bar{R} = R(1, 1)$.

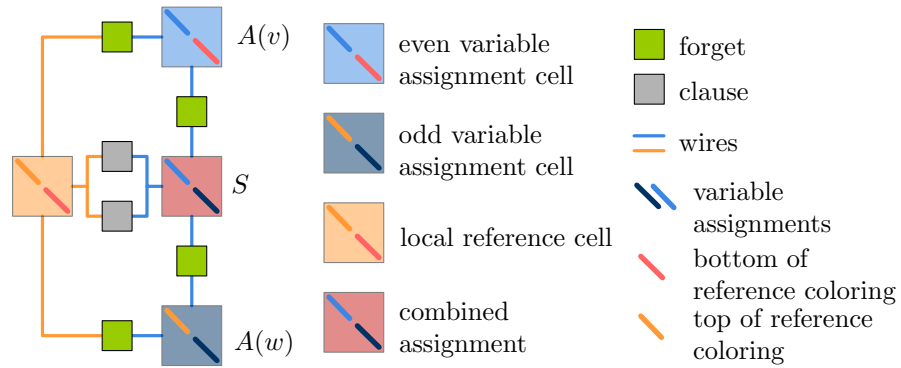

Figure 10: Overview of the consistency gadget. The clause gadgets serve to realize the equality constraints $\mathcal{C}(v, w)$.

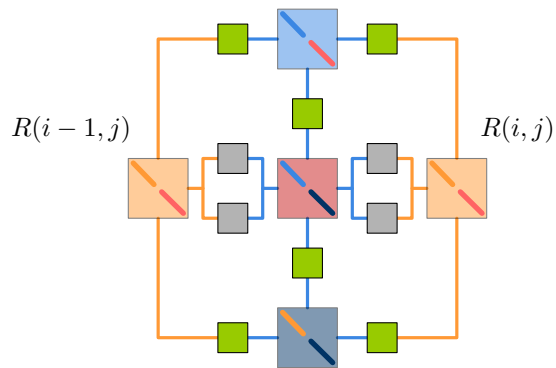

Figure 11: Two consistency gadgets ensure propagation of the reference coloring.

552 *Proof.* To show this, we will prove that the coloring of $R(i, j)$ is the same as the coloring of
 553 $R(i - 1, j)$ for each $2 \leq i \leq g - 1$ and $j \in [g - 1]$. The case for $R(i, j - 1)$ is analogous, and
 554 the claim follows inductively.

555 Let $v = (i, j)$ and $w = (i, j + 1)$ be cells of I . Note that v and w are adjacent and
 556 $A(v)$ and $A(w)$ are associated with both $R(i - 1, j)$ and $R(i, j)$. Without loss of generality
 557 assume that v is even and w is odd, see Fig. 11 for illustration.

558 Intuitively, the consistency gadget corresponding to the edge vw and the left face
 559 bounded by vw (we shall call it the left consistency gadget) is responsible for copying one
 560 half of the coloring of $R(i - 1, j)$ to $A(v)$ and the other half to $A(w)$. Analogously, the
 561 consistency gadget corresponding to vw and the right face bounded by vw (we shall call
 562 it the right consistency gadget) is responsible for copying these halves to $R(i, j)$, making
 563 sure that the coloring of $R(i, j)$ is exactly the same as the coloring of $R(i - 1, j)$. More
 564 formally, for $f \in [\ell]$, by p_f, q_f, r_f , and r'_f we denote, respectively, the points of $A(v), A(w),$
 565 $R(i - 1, j)$, and $R(i, j)$. By the correctness of the left consistency gadget, we know that for
 566 every coloring φ , we have:

- 567 • $\varphi(r_f) = \varphi(q_f)$ for all $f \in [2k]$,
- 568 • $\varphi(r_f) = \varphi(p_f)$ for all $f \in [4k] \setminus [2k]$.

569 Analogously, by the correctness of the right consistency gadget, we know that for every
 570 coloring φ , we have:

- 571 • $\varphi(q_f) = \varphi(r'_f)$ for all $f \in [2k]$,
- 572 • $\varphi(p_f) = \varphi(r'_f)$ for all $f \in [4k] \setminus [2k]$.

573 This shows that $\varphi(r_f) = \varphi(r'_f)$ for every coloring φ and every $f \in [\ell]$, which proves the
 574 claim. \square

575 **Claim 2.** The following statements are true.

- 576 1. The coloring of each $A(v)$ is one of the standard colorings.
- 577 2. For each pair of adjacent cells v, w of I , all local constraints $\mathcal{C}(v, w)$ are satisfied.
- 578 3. For each cell v of I , all constraints $\mathcal{C}(v)$ are satisfied.

579 The claim follows directly from Claim 1 and the correctness of forget, clause-checking,
 580 and consistency gadgets.

581 Now, observe that the total number of points in F is $n = O(g^2\ell) = O(n')$, where
 582 $n' = g^2k$ is the total number of variables in I . Thus, the existence of an algorithm solving J
 583 in time $2^{o(\sqrt{n\ell})}$ could be used to solve I in time $2^{o(\sqrt{n'k})}$, which, by Theorem 7, contradicts
 584 the ETH. \square

585 **5 Higher Dimensional Lower Bounds**

586 Recall that in the hardness proof of 2-GRID 3-SAT and PARTIAL 2-GRID COLORING (see
 587 Theorems 7 and 8) we started with a 3-SAT instance with N variables and $\Theta(N)$ clauses,
 588 we formed $g = \Theta(N/k)$ groups, each containing $O(k)$ variables, and we arranged them on
 589 in such a way that every pair of groups met in a separate grid cell. This required $O(g^2)$ grid
 590 cells.

591 Suppose we want to try a similiar approach to obtain a tight (i.e., matching the
 592 upper bound in Theorem 5 lower bound in $d \geq 3$ dimensions. We observe that the naive
 593 approach of creating $\Theta(N/k)$ groups is not enough. Indeed, a standard computation shows
 594 that the bound in Theorem 5 is attained for the grid $R[g, d]$ with $g = \Theta((N/k)^{1/(d-1)})$ and k
 595 variables/points per cell. Thus we have to refine our reduction from 3-SAT to d -GRID 3-SAT.

596 **5.1 Embeddings**

597 For integers $g, d \geq 1$, we denote by $H[g, d]$ the d -dimensional *Hamming grid*, i.e., a graph
 598 whose vertices are all points from $[g]^d$, and two vertices are adjacent if their Hamming
 599 distance is exactly one (in other words, they differ on exactly one coordinate).

600 An *embedding* of a graph F into a graph G is a mapping $f: V(F) \rightarrow 2^{V(G)}$, such
 601 that:

- 602 • for each $v \in V(F)$, the set $f(v)$ is connected in G ,
- 603 • for each edge uv of G , the sets $f(u)$ and $f(v)$ *touch*, i.e., either they have a non-empty
 604 intersection or there is an edge in G joining a vertex from $f(u)$ to a vertex of $f(v)$.

605 The *depth* of an embedding f is the maximum number of vertices of F mapped to sets
 606 containing the same vertex of G , that is $\max\{|S| : S \subseteq V(F) \text{ and } \bigcap_{v \in S} f(v) \neq \emptyset\}$.

607 Observe that if f is an embedding of G into F with depth D , and f' is an embedding
 608 of F into H with depth D' , then the composition $f' \circ f$ of f and f' is an embedding of F
 609 into H with depth $D \cdot D'$.

610 Now we will present a series of results about graph embeddings. We start with
 611 embedding arbitrary graphs into Hamming grids.

612 **Theorem 9** (Marx, Sidiropoulos [25]). *Let $d \geq 2$. For every graph G with m edges, no
 613 isolated vertices, and with maximum degree Δ , there is an embedding f from G to $H[g, d-1]$
 614 having depth $O(d^2 \Delta)$, where $g = O(m^{1/(d-1)} \cdot \frac{\log m}{\log \log m})$. Moreover, such an embedding can
 615 be found in deterministic polynomial time.*

616 The next step will be embedding a Hamming grid into another, smaller Hamming
 617 grid.

618 **Lemma 10.** *For every $g, d \geq 1$ and every $k = O(g^d)$, there exists $g' = O(g/k^{1/d})$ and an
 619 embedding f of $H[g, d]$ into $H[g', d]$ with depth $O(k)$. Moreover, this embedding can be found
 620 in deterministic polynomial time.*

621 *Proof.* Let $s = \lfloor k^{1/d} \rfloor$ and $g' = \lceil g/s \rceil = O(g/k^{1/d})$. Let $v = (a_1, a_2, \dots, a_d)$ be a vertex of
 622 $H[g, d]$. We define f by mapping v to the singleton containing $(1 + \lfloor a_1/s \rfloor, 1 + \lfloor a_2/s \rfloor, \dots, 1 +$
 623 $\lfloor a_d/s \rfloor)$. Note that the number of vertices of $H[g, d]$ mapped to a single vertex is $s^d = O(k)$
 624 It is straightforward to verify that f is an embedding. \square

625 Finally, Hamming grids can be embedded in grids.

626 **Theorem 11** (Marx, Sidiropoulos [25]). *For every $d, g \geq 1$ there is an embedding f from*
 627 *$H[g, d-1]$ to $R[g, d]$ having depth at most d . Moreover, such an embedding can be found in*
 628 *deterministic polynomial time.*

629 Now, by combining the above results, we show how we can efficiently embed an
 630 incidence graph of a 3-SAT formula into the grid.

631 **Lemma 12.** *Let Φ be a 3-SAT formula over the variable set $Var = \{x_1, x_2, \dots, x_N\}$, such*
 632 *that each variable appears in at most $\Delta \geq 3$ clauses, and let $k = O(N)$ be an integer. There*
 633 *exists $g = O(\Delta(\Delta N/k)^{1/(d-1)} \cdot \frac{\log(\Delta N)}{\log \log(\Delta N)})$ and a mapping φ of variables of Φ to subsets of*
 634 *vertices of $R[g, d]$, such that:*

- 635 (i) *for every $x \in Var$, the set $\varphi(x)$ is connected,*
- 636 (ii) *for every $v \in V(R[g, d])$, the number of variables x such that $v \in \varphi(x)$ is $O(\Delta d^3 k)$,*
- 637 (iii) *for every clause C , there exists a vertex $v(C) \in V(R[g, d])$ such that $v(C) \in \bigcap_{x \in C} \varphi(x)$*
 638 *(if there is more than one such vertex, we set $v(C)$ to be any of them);*
- 639 (iv) *if for two clauses C, C' it holds that $v(C) = v(C')$, then C and C' are variable-disjoint.*

640 *Moreover, such a mapping can be found in polynomial time.*

641 *Proof.* Let $\mathcal{C} = \{C_1, C_2, \dots, C_M\}$ be the set of clauses of Φ . Consider an incidence graph G of
 642 Φ , i.e., the bipartite graph with the vertex set $Var \cup \mathcal{C}$, and the edge set $\{xC : x \in Var, C \in \mathcal{C},$
 643 $\text{and } x \in C\}$. Note that the maximum degree of G is Δ .

644 By Theorem 9, we can find an embedding f from G to $H[g', d-1]$ for $g' =$
 645 $O((\Delta N)^{1/(d-1)} \cdot \frac{\log(\Delta N)}{\log \log(\Delta N)})$, with depth $O(d^2 \Delta)$. Now, by Lemma 10, there exists an embed-
 646 ding f' of $H[g', d-1]$ into $H[g'', d-1]$ for $g'' = O(g'/k^{1/(d-1)}) = O((\Delta N/k)^{1/(d-1)} \cdot \frac{\log(\Delta N)}{\log \log(\Delta N)})$
 647 with depth $O(k)$. By Theorem 11, there is an embedding f'' of $H[g'', d-1]$ into $R[g'', d]$
 648 with depth at most d .

649 Let $b = 3\Delta + 1$. Next, consider the following depth-1 embedding f''' of $R[g'', d]$
 650 into $R[g, d]$, where $g = bg'' = O(\Delta(\Delta N/k)^{1/(d-1)} \cdot \frac{\log(\Delta N)}{\log \log(\Delta N)})$. For $a = (a_1, a_2, \dots, a_d) \in$
 651 $V(R[g'', d])$, we define $f'''(a) = \bigcup_{q=1}^d \bigcup_{p=0}^{b-1} \{(ba_1, ba_2, \dots, ba_d) + pe_q\}$.

652 The composition φ' of f, f', f'' , and f''' is an embedding of G into $R[g, d]$ with depth
 653 $O(d^3 \Delta k)$.

654 By the properties of f''' , we observe that for every clause C the set $\varphi'(C)$ contains
 655 a vertex of the form ba , where $a = (a_1, a_2, \dots, a_d)$ for integers a_1, a_2, \dots, a_d . We set $v'(C)$
 656 to be such a vertex (if there is more than one, we pick an arbitrary one).

657 Consider a clause C and let $v'(C) = ba$ for $a = (a_1, a_2, \dots, a_d)$. Let \mathcal{C}' be the set
 658 of clauses C' , such that $v'(C') = ba$. We want to partition \mathcal{C}' into at most $b - 1 = 3\Delta$
 659 groups $\mathcal{C}'_1, \mathcal{C}'_2, \dots, \mathcal{C}'_{b-1}$, such that the clauses in one group are variable-disjoint. We can
 660 easily do it with a greedy algorithm – note that each clause may share a variable with at
 661 most $3(\Delta - 1) < 3\Delta$ other clauses. Now, for every clause C of \mathcal{C}'_i , for $i \in [b - 1]$, we will
 662 extend φ' , by including $v(C) := ba + ie_1 + e_2$ in $\varphi'(C)$. It is not hard to verify that φ' is
 663 still an embedding of G into $R[g, d]$ with depth $O(d^3\Delta k)$.

664 Finally, for every $x \in Var$, we define a mapping φ of variables of Φ to subsets of
 665 vertices of $R[g, d]$ in the following way: $\varphi(x) = \varphi'(x) \cup \bigcup_{C: x \in C} \varphi'(C)$. Note that each $\varphi(x)$
 666 is connected, since $\varphi'(x)$ and every $\varphi'(C)$ is connected, and $\varphi'(x)$ and $\varphi'(C)$ touch whenever
 667 $x \in C$.

668 Moreover, recall that the depth of φ' is $O(d^3\Delta k)$. Since the number of variables
 669 mapped by φ to any fixed vertex of $R[g, d]$ is at most three times larger, so it is $O(d^3\Delta k)$.
 670 The last two properties follow from the observation that $v(C)$ belongs to $\varphi(x)$ for every
 671 $x \in C$. □

672 Now we are ready to prove the following theorem, which is a generalization of The-
 673 orem 7 to higher dimensions.

674 **Theorem 13.** *For any integer $d \geq 3$ and reals $\epsilon > 0$ and $0 \leq \alpha \leq 1$, there is no algorithm*
 675 *solving d -GRID 3-SAT with n variables in total and $k = \Theta(n^\alpha)$ variables per cell in time*
 676 $2^{O\left(n^{\frac{d-1+\alpha}{d}-\epsilon}\right)} = 2^{O(n^{1-1/d-\epsilon}k^{1/d})}$, *unless the ETH fails.*

677 *Proof.* Let Φ be a 3-SAT instance with N variables and $\Theta(N)$ clauses, and let each variable
 678 appear in at most $\Delta = 3$ clauses. By the ETH and the Sparsification Lemma [19], there is
 679 no algorithm deciding the satisfiability of Φ in time $2^{o(N)}$.

680 Let $k = \Theta\left(\left(\frac{N^{1/(d-1)} \log N}{\log \log N}\right)^{d/(1/(d-1)+1/\alpha)}\right)$, $g = O\left((N/k)^{1/(d-1)} \cdot \frac{\log N}{\log \log N}\right)$, and let
 681 φ be the mapping of variables of Φ to the subsets of vertices of $R[g, d]$ given by Lemma 12
 682 (recall that $\Delta = 3$).

683 Now we construct an instance $I(\Phi)$ just as we did in the proof of Theorem 7. For
 684 every cell v of $R[g, d]$ we add variables $\varphi^{-1}(v)$. For each clause C , we add the clause
 685 constraint to the cell $v(C)$. Moreover, using equality constraints, we ensure that all copies
 686 of the same variable get the same truth assignment (recall that each set $\varphi(x)$ is connected).
 687 It is clear that $I(\Phi)$ is a satisfiable instance of d -GRID 3-SAT if and only if Φ is satisfiable.

The number of cells in $I(\Phi)$ is $g^d = O\left((N/k)^{d/(d-1)} \left(\frac{\log N}{\log \log N}\right)^d\right)$. The total number

of variables is thus

$$n = g^d k = O\left(\left(\frac{N}{k}\right)^{d/(d-1)} k \cdot \left(\frac{\log N}{\log \log N}\right)^d\right) = O\left(\left(N^d/k\right)^{1/(d-1)} \cdot \left(\frac{\log N}{\log \log N}\right)^d\right),$$

688 and a direct computation shows that $k = \Theta(n^\alpha)$.

689 Suppose we have an algorithm solving d -GRID 3-SAT in time $2^{O\left(n^{\frac{d-1+\alpha}{d}-\epsilon}\right)}$ for some
 690 $\epsilon > 0$. Applying it to $I(\Phi)$ gives a total running time $\exp\left(O\left(n^{\frac{d-1+\alpha}{d}-\epsilon}\right)\right) = 2^{o(N)}$. So we
 691 can use this algorithm to solve Φ in time $2^{o(N)}$, thus refuting the ETH. \square

692 5.2 Reduction from d -grid 3-Sat to Partial d -grid Coloring

693 After establishing the hardness of d -GRID 3-SAT, we can proceed to showing the hardness
 694 of PARTIAL d -GRID COLORING.

695 **Theorem 14.** *For any integer $d \geq 3$, and reals $0 \leq \alpha \leq 1$ and $\epsilon > 0$, there is no*
 696 *$2^{O(n^{1-1/d-\epsilon}\ell^{1/d})}$ algorithm solving PARTIAL d -GRID COLORING on a total of n points and*
 697 *$\ell = \Theta(n^\alpha)$ points in each cell, unless the ETH fails.*

698 The proof of Theorem 14 is a consequence of Theorem 13 and of the gadgets con-
 699 structed in Section 4. The reduction is now from d -GRID 3-SAT and we only have to very
 700 slightly adapt the construction. The overall picture is the grid-like structure of Figure 6
 701 extended to dimension d . From an instance I of d -GRID 3-SAT produced by the reduction
 702 of Theorem 13 on the grid $R[g, d]$ with k variables per cell, we build an equivalent instance
 703 J of PARTIAL d -GRID COLORING on a subgraph of $R[g', d]$ with $g' = \Theta(g)$ with $\ell := 4k$
 704 points (and colors), in the following way. A cell of I is again called *even* (resp. *odd*) if
 705 its coordinates sum up to an even integer (resp. odd integer). For each even/odd cell of
 706 I , we have a corresponding even/odd *standard* cell in J (in the grid $R[g', d]$). We define
 707 similarly a *standard cell* as a cell in which the ℓ points p_1, \dots, p_ℓ are in the main diagonal,
 708 i.e., $p_i = (i, i, \dots, i) \in [\ell]^d$ for all $i \in [\ell]$. Observe that, as in the 2-dimensional case, two
 709 adjacent standard cells have to be colored in the same way (see Figure 12).

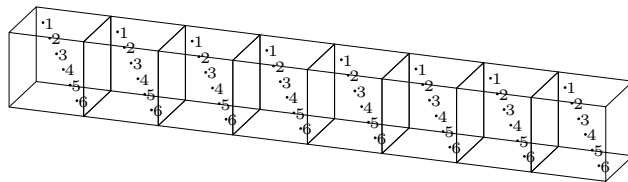

Figure 12: A wire in dimension 3. The coloring of any cell forces the same coloring in the others.

710 In each even/odd cell of J , the truth assignment of the k variables is encoded the
 711 same way as in the 2-dimensional case. Each of those cells are wired via a constant number
 712 (four is enough) of adjacent standard cells to one clause gadget (responsible for ensuring
 713 the satisfiability of the clauses on those very variables). One can notice that, planarity not

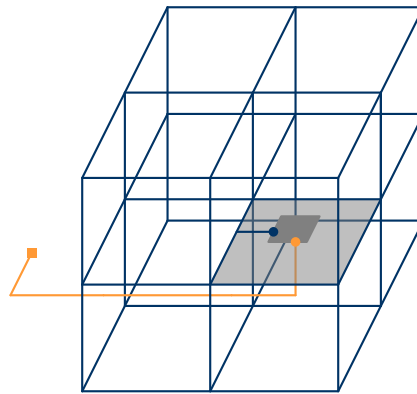

Figure 13: Wiring the reference coloring (depicted in blue), to the place where it is needed.

714 being an obstacle anymore, bringing the reference coloring to the clause gadgets is no longer
 715 a delicate issue. We can therefore simplify a bit our reduction for $d \geq 3$.

716 First, we do not require the local reference coloring cells of the planar case. Now, we
 717 only have one global reference coloring cell, and we wire this cell to every clause gadget. We
 718 can do it, as all gadgets are embedded in a two-dimensional subspace, so we can always
 719 use extra dimensions to find place for wires (see Fig. 13).

720 Secondly, we no longer need two consistency gadgets between two adjacent even and
 721 odd cells. Now, between every even cell (resp. every odd cell) and each of its $2d$ neighboring
 722 odd cells (resp. even cells), we have one consistency gadget. Each even/odd cell is attached
 723 to $2d$ wires as represented in Figure 14 in dimension 3.

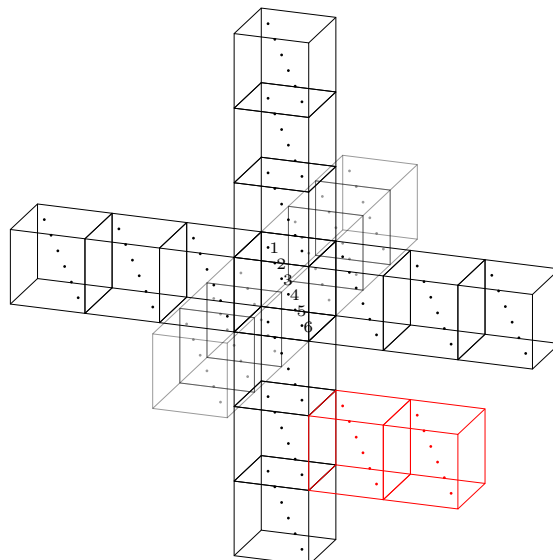

Figure 14: The $2d$ wires leaving a, say, even cell to reach each one of the $2d$ consistency gadgets shared with the $2d$ adjacent odd cells. The cells in red are part of the wires to the clause gadget.

724 Every consistency and clause gadget is embedded into a plane (subset of cells in
 725 an affine subspace of dimension 2) supported by say, e_1 and e_2 , the first two vectors of
 726 the canonical basis. The wires which should be plugged to the corresponding gadget are
 727 naturally guided towards the plane (see Figure 15 where we give the example of the clause
 728 gadget). This construction can be realized with $g' = 100g$. The soundness follows from the
 729 2-dimensional case.

730 It is noteworthy that we are not using the extra dimensions for those crucial gadgets.
 731 The higher dimensional space is mainly needed and used in Section 5.1 to get Theorem 13.

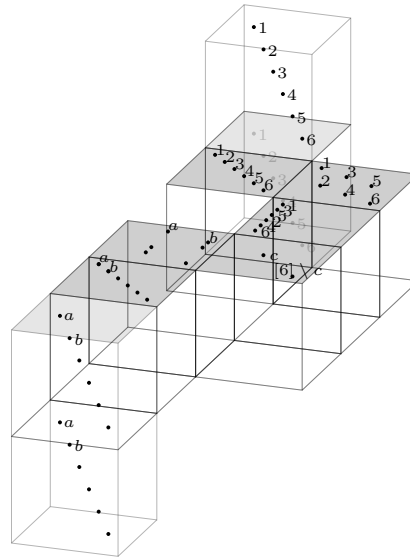

Figure 15: The clause gadget in dimension 3. The wires meet in a plane where the information is projected to 2 dimensions. The core of the gadget is then identical to the 2-dimensional case.

732 The final step in proving the lower bound in Theorem 3 is reducing PARTIAL d -GRID
 733 COLORING to ℓ -COLORING of an intersection graph of d -dimensional unit balls. It is very
 734 similar to the one in Theorem 1 (see also [24, Theorem 3.1.]).

735 5.3 Reduction from Partial d -grid Coloring to ℓ -Coloring of unit d -ball graphs

736 *Proof of the third and last step of the lower bound of Theorem 3.* There is a transparent re-
 737 duction from PARTIAL d -GRID COLORING to ℓ -COLORING on intersection graphs of d -
 738 dimensional balls. Recall that the points of an instance of PARTIAL d -GRID COLORING
 739 are in $[\ell]^d$ in each cell, and that the cells created by the reduction of Theorem 14 are in $[g']^d$
 740 with $g' = \Theta(g)$.

741 One turns every point $(x_1, \dots, x_d) \in [\ell]^d$ of every cell at position $(i_1, \dots, i_d) \in [g']^d$
 742 into a d -dimensional ball centered at $((2(d-1)\ell^2 + 0.1)i_1 + x_1, \dots, (2(d-1)\ell^2 + 0.1)i_d + x_d)$.
 743 The common radius of all the balls is set to $(d-1)\ell^2$, and we set the number of colors to ℓ .
 744 The correctness of this reduction is similar to the 2-dimensional case and is detailed in [25,

745 Theorem 3.1.]. □

746 6 Segments

747 First we will present the hardness proof for the list coloring problem, and then we will show
 748 how to modify it to obtain the result for 6-coloring. The segments in our construction will
 749 be axis-parallel, the class of intersection graphs of such segments is denoted by 2-DIR. In
 750 the description, we will identify the vertices of the intersection graph with the segments.

751 **Theorem 15.** *There is no algorithm working in time $2^{o(n)}$ for the list 6-coloring of 2-DIR*
 752 *graphs with n vertices, unless the ETH fails.*

753 *Proof.* We reduce from 3-coloring of graphs with maximum degree at most 4. Let G be a
 754 graph with n vertices and $m = \Theta(n)$ edges. It is a folklore result that, assuming the ETH,
 755 there is no algorithm solving this problem in time $2^{o(n)}$ (see for instance Lemma 1 in [5]).

756 Let the vertex set of G be $V = \{v_1, v_2, \dots, v_n\}$. We construct a 2-DIR graph G' with
 757 lists L of colors from the set $\{1, 2, 3, 4, 5, 6\}$, such that G is 3-colorable if and only if G' is
 758 list-colorable with respect to the lists L .

759 For each vertex v_i we introduce two segments: a horizontal one, called x_i , and a
 760 vertical one, called y_i , so that they form a half of a $n \times n$ grid (see Figure 16). When i
 761 increases, x_i becomes longer and y_i shorter. One may observe that the intersection graph
 762 induced by those segments is *not* grid-like. We set the lists of each x_i to $\{1, 2, 3\}$ and the
 763 lists of each y_i to $\{4, 5, 6\}$.

764 Each color $c \in \{1, 2, 3\}$ will be identified with the color $c + 3$. Thus, we want to
 765 ensure that in any feasible 6-coloring f of G' we have:

- 766 1. $f(x_i) + 3 = f(y_i)$ for all $i \in [n]$,
- 767 2. $f(x_i) + 3 \neq f(y_j)$ for all $i > j$ such that $v_i v_j$ is an edge of G .

768 This is achieved by using *equality gadgets* and *inequality gadgets*. At the crossing point of
 769 x_i and y_i , we put an equality gadget (represented by a circle on Figure 16). Moreover, for
 770 each edge $v_i v_j$ of G , we put an inequality gadget at the crossing point of x_i and y_j , $i > j$
 771 (represented by a square on Figure 16).

772 The equality gadget consists of 9 segments, arranged as depicted on Figure 17. Con-
 773 sider the equality gadget and suppose x_i gets the color 1. Then a_1 receives color 4, and b_1
 774 and c_1 colors 5 and 6, respectively. Thus the only choice for the color for y_i is 4. This can
 775 be extended to remaining segments of the gadget e.g. by coloring a_2 with color 2, a_3 with
 776 color 3, b_2, c_2 with color 5, and b_3, c_3 with color 6. The other cases are symmetric.

777 The inequality gadget consists of 7 segments, arranged as depicted on Figure 18. So
 778 now consider an inequality gadget and suppose the color of x_i is 1. Then p_1 and p_2 get
 779 colors 5 and 6, respectively. Thus the only choice for x' is 4, which prevent y_j from receiving
 780 color 4. This coloring can be extended to remaining segments by coloring q_1, q_2 with color
 781 2 and r_1, r_2 with color 3. The other cases are again symmetric.

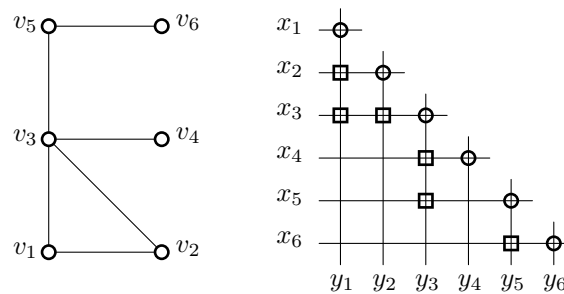

Figure 16: A graph G (left) and a high-level construction of G' (right). Circles denote equality gadgets and squares denote inequality gadget

This proves that G' has a coloring with lists L if and only if G is 3-colorable.

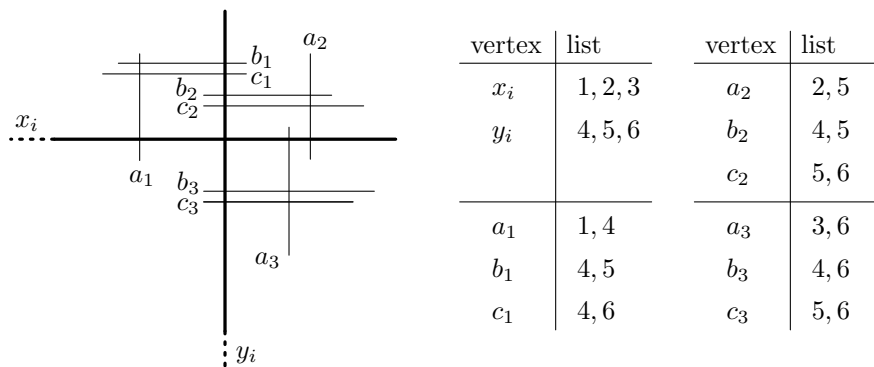

Figure 17: Equality gadget.

782

783 The number of vertices of G' is $n' = \underbrace{2n}_{x_i, y_i} + \underbrace{9n}_{\text{equality}} + \underbrace{7m}_{\text{inequality}} = \Theta(n)$.

784 Now suppose we can find a list coloring of G' in time $2^{o(n')}$. This yields an algorithm
 785 for 3-coloring of G in time $2^{o(n')} = 2^{o(n)}$, which in turn contradicts the ETH. \square

786 To obtain Theorem 2, we modify the construction above to simulate the lists of
 787 available colors.

788 **Theorem 2.** *There is no $2^{o(n)}$ time algorithm for 6-COLORING the intersection graph of*
 789 *line segments in the plane, unless the ETH fails.*

790 *Proof.* We modify the construction from the proof of Theorem 15. We first introduce six
 791 overlapping segments R_1, R_2, \dots, R_6 , whose coloring will serve as a reference coloring. Since
 792 these segments are pairwise intersecting, each of them receives a different color. We will
 793 denote by $i \in \{1, 2, \dots, 6\}$ the color assigned to R_i .

794 Now, for each segment v of G' , we want to simulate the list $L(v)$ from the instance
 795 of list 6-coloring constructed in the proof of Theorem 15. For every color $i \notin L(v)$, we want

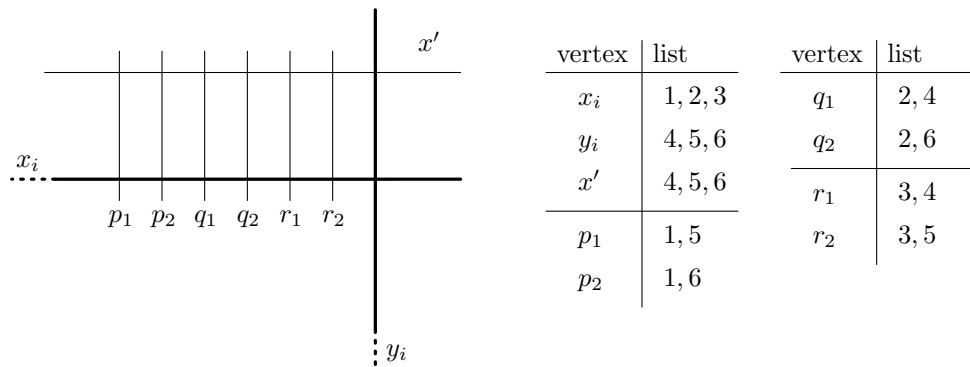

Figure 18: Inequality gadget.

796 to introduce a segment s_i intersecting v , which will always receive color i .

797 To achieve this, we first need to transport the reference coloring to every gadget.
 798 We will do it using bundles of overlapping segments, the overall high-level idea is depicted
 799 in Figure 19. We make sure that a bundle consisting of overlapping segments colored 1,2,3
 800 intersects all y_i 's, and a bundle consisting of overlapping segments colored 4,5,6 intersects
 801 all x_i 's. Observe that this already simulates the lists for every x_i, y_i ($i \in [n]$).

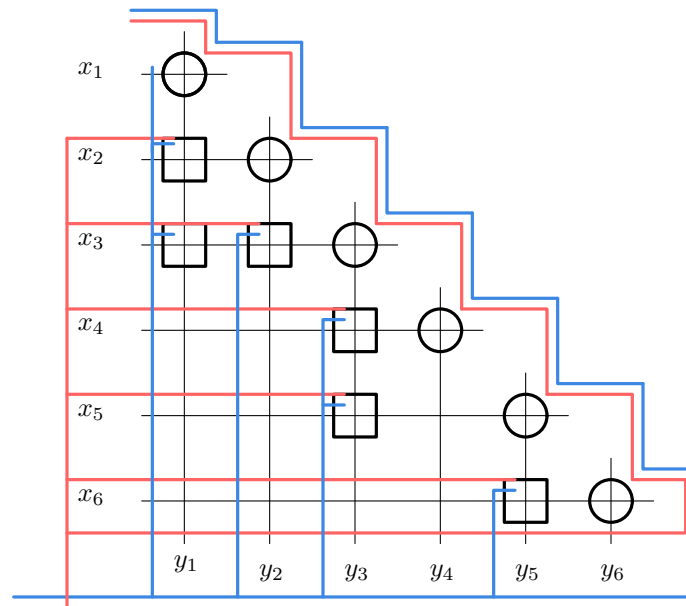

Figure 19: Reference coloring is transported to every gadget. Red and blue lines denote, respectively, triples of overlapping segments with colors 1,2,3, and 4,5,6. Parallel lines depicted close to each other are in fact overlapping. Segments R_1, R_2, \dots, R_6 are positioned in the lower left corner of the picture.

802 Such a construction relies on a constant-size gadget, which allows us to split, join,
 803 or turn the reference coloring. In other words, we want to be able to split a bundle into two

804 perpendicular bundles, carrying the same information (splitting, see e.g. red bundles in the
 805 left of Figure 19), join two bundles carrying distinct sets of colors into a single one (joining,
 806 this happens next to the inequality gadgets), or change the orientation of a bundle from a
 807 horizontal to vertical (turning, see the top-right bundles in Figure 19). We always need to
 808 make sure that the color of each overlapping segment in the bundle is uniquely determined.

809 The construction of the gadget for splitting a bundle of six segments is depicted in
 810 Figure 20. Turning a bundle or splitting a bundle of three colors can be easily realized
 811 by finishing unnecessary segments just after leaving the gadget. Also note that joining is
 812 actually the same as splitting. In order to join two perpendicular bundles, each carrying
 813 three colors, we add three segments to each of bundles (this will make sure that they receive
 814 the colors not appearing in the bundle), and attaching the extended bundles to a split
 815 gadget.

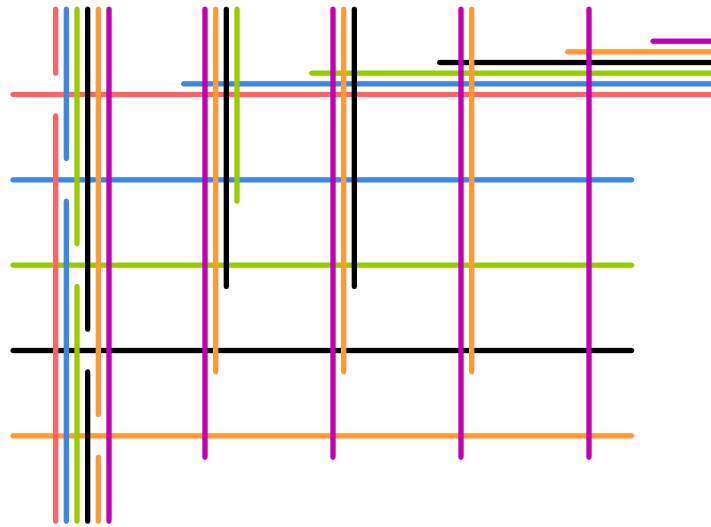

Figure 20: Split gadget for 6 colors. The parallel segments depicted close to each other are in fact overlapping. Observe that the depicted 6-coloring is the only possible (up to the permutation of colors).

816 Note that the number of segments in this gadget is constant. Now, the only thing left
 817 is to connect every segment in every gadget to appropriate segments carrying the reference
 818 coloring. This can easily be done using a constant number of additional segments per gadget
 819 (see Figure 21).

820 The total size of the construction increases by a constant factor, as we introduce
 821 $O(n)$ constant-size split gadgets. Thus an algorithm for 6-coloring the constructed 2-DIR
 822 graph in time $2^{o(n')}$ could be used to 3-color the input graph G in time $2^{o(n)}$, contradicting
 823 the ETH. \square

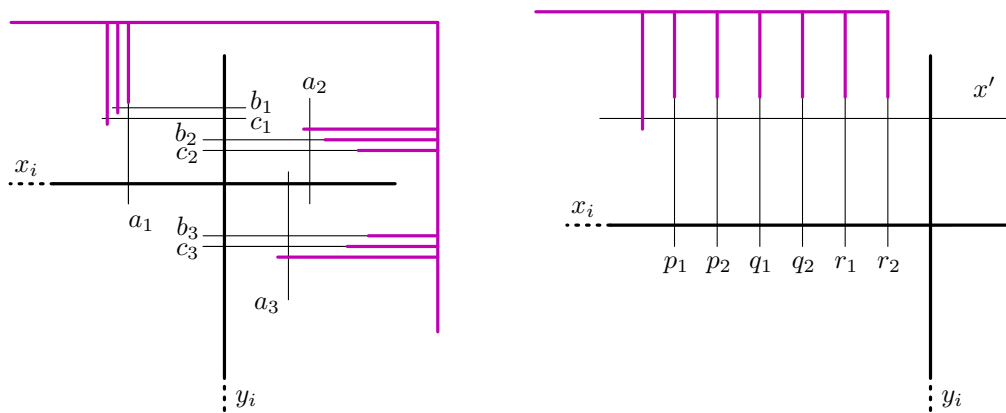

Figure 21: Simulation of lists for vertices in equality and inequality gadgets. Violet lines denote tuples of overlapping segments, carrying the reference coloring. We finish unwanted segments just after leaving the turning gadgets.

824 References

- 825 [1] J. Alber and J. Fiala. Geometric separation and exact solutions for the parameterized
826 independent set problem on disk graphs. *J. Algorithms*, 52(2):134–151, 2004.
- 827 [2] É. Bonnet and P. Rzażewski. Optimality program in segment and string graphs. *CoRR*,
828 abs/1712.08907, 2017.
- 829 [3] J. Cardinal. Computational geometry column 62. *SIGACT News*, 46(4):69–78, 2015.
- 830 [4] R. H. Chitnis, M. Hajiaghayi, and D. Marx. Tight bounds for Planar Strongly Con-
831 nected Steiner Subgraph with fixed number of terminals (and extensions). In *SODA*
832 *2014 Proc.*, pages 1782–1801, 2014.
- 833 [5] M. Cygan, F. V. Fomin, A. Golovnev, A. S. Kulikov, I. Mihajlin, J. W. Pachocki, and
834 A. Socała. Tight lower bounds on graph embedding problems. *CoRR*, abs/1602.05016,
835 2016.
- 836 [6] M. Cygan, F. V. Fomin, L. Kowalik, D. Lokshtanov, D. Marx, M. Pilipczuk,
837 M. Pilipczuk, and S. Saurabh. *Parameterized Algorithms*. Springer Publishing Com-
838 pany, Incorporated, 1st edition, 2015.
- 839 [7] E. D. Demaine, F. V. Fomin, M. T. Hajiaghayi, and D. M. Thilikos. Bidimensional
840 parameters and local treewidth. *SIAM J. Discrete Math.*, 18(3):501–511, 2004.
- 841 [8] E. D. Demaine, F. V. Fomin, M. T. Hajiaghayi, and D. M. Thilikos. Fixed-parameter
842 algorithms for (k, r) -Center in planar graphs and map graphs. *ACM Transactions on*
843 *Algorithms*, 1(1):33–47, 2005.
- 844 [9] E. D. Demaine, F. V. Fomin, M. T. Hajiaghayi, and D. M. Thilikos. Subexponential
845 parameterized algorithms on bounded-genus graphs and H -minor-free graphs. *J. ACM*,
846 52(6):866–893, 2005.

- 847 [10] E. D. Demaine and M. Hajiaghayi. The bidimensionality theory and its algorithmic
848 applications. *Comput. J.*, 51(3):292–302, 2008.
- 849 [11] E. D. Demaine and M. Hajiaghayi. Linearity of grid minors in treewidth with applica-
850 tions through bidimensionality. *Combinatorica*, 28(1):19–36, 2008.
- 851 [12] E. D. Demaine and M. T. Hajiaghayi. Fast algorithms for hard graph problems: Bidi-
852 mensionality, minors, and local treewidth. In *GD 2014 Proc.*, pages 517–533, 2004.
- 853 [13] F. Dorn, F. V. Fomin, D. Lokshtanov, V. Raman, and S. Saurabh. Beyond bidimension-
854 ality: Parameterized subexponential algorithms on directed graphs. In *STACS 2010*
855 *Proc.*, pages 251–262, 2010.
- 856 [14] F. Dorn, F. V. Fomin, and D. M. Thilikos. Subexponential parameterized algorithms.
857 *Computer Science Review*, 2(1):29–39, 2008.
- 858 [15] F. Dorn, E. Penninkx, H. L. Bodlaender, and F. V. Fomin. Efficient exact algorithms
859 on planar graphs: Exploiting sphere cut decompositions. *Algorithmica*, 58(3):790–810,
860 2010.
- 861 [16] F. V. Fomin, S. Kratsch, M. Pilipczuk, M. Pilipczuk, and Y. Villanger. Tight bounds
862 for parameterized complexity of cluster editing with a small number of clusters. *J.*
863 *Comput. Syst. Sci.*, 80(7):1430–1447, 2014.
- 864 [17] F. V. Fomin, D. Lokshtanov, V. Raman, and S. Saurabh. Subexponential algorithms
865 for partial cover problems. *Inf. Process. Lett.*, 111(16):814–818, 2011.
- 866 [18] F. V. Fomin and D. M. Thilikos. Dominating sets in planar graphs: Branch-width and
867 exponential speed-up. *SIAM J. Comput.*, 36(2):281–309, 2006.
- 868 [19] R. Impagliazzo, R. Paturi, and F. Zane. Which problems have strongly exponential
869 complexity? *J. Comput. Syst. Sci.*, 63(4):512–530, 2001.
- 870 [20] P. N. Klein and D. Marx. Solving Planar k -Terminal Cut in $O(n^{c\sqrt{k}})$ time. In *ICALP*
871 *2012 Proc.*, pages 569–580, 2012.
- 872 [21] P. N. Klein and D. Marx. A subexponential parameterized algorithm for Subset TSP
873 on planar graphs. In *SODA 2014 Proc.*, pages 1812–1830, 2014.
- 874 [22] D. Marx. Efficient approximation schemes for geometric problems? In *ESA 2005 Proc.*,
875 pages 448–459, 2005.
- 876 [23] D. Marx and M. Pilipczuk. Optimal parameterized algorithms for planar facility loca-
877 tion problems using voronoi diagrams. In N. Bansal and I. Finocchi, editors, *ESA 2015*
878 *Proc.*, volume 9294 of *LNCS*, pages 865–877. Springer, 2015.
- 879 [24] D. Marx and A. Sidiropoulos. The limited blessing of low dimensionality: When $1-1/d$
880 is the best possible exponent for d -dimensional geometric problems. *SOCG 2014 Proc.*,
881 pages 67:67–67:76, New York, NY, USA, 2014. ACM.

- 882 [25] D. Marx and A. Sidiropoulos. The limited blessing of low dimensionality: When
883 $1-1/d$ is the best possible exponent for d -dimensional geometric problems. *CoRR*,
884 abs/1612.01171, 2016.
- 885 [26] G. L. Miller, S.-H. Teng, W. Thurston, and S. A. Vavasis. Separators for sphere-packings
886 and nearest neighbor graphs. *J. ACM*, 44(1):1–29, Jan. 1997.
- 887 [27] M. Pilipczuk, M. Pilipczuk, P. Sankowski, and E. J. van Leeuwen. Subexponential-
888 time parameterized algorithm for Steiner Tree on planar graphs. In *STACS 2013 Proc.*,
889 pages 353–364, 2013.
- 890 [28] M. Pilipczuk, M. Pilipczuk, P. Sankowski, and E. J. van Leeuwen. Network sparsifica-
891 tion for steiner problems on planar and bounded-genus graphs. In *FOCS 2014 Proc.*,
892 pages 276–285. IEEE Computer Society, 2014.
- 893 [29] W. D. Smith and N. C. Wormald. Geometric separator theorems. available online at
894 <https://www.math.uwaterloo.ca/~nwormald/papers/focssep.ps.gz>.
- 895 [30] W. D. Smith and N. C. Wormald. Geometric separator theorems and applications.
896 FOCS 1998 Proc., pages 232–243, Washington, DC, USA, 1998. IEEE Computer Soci-
897 ety.
- 898 [31] D. M. Thilikos. Fast sub-exponential algorithms and compactness in planar graphs. In
899 *ESA 2011 Proc.*, pages 358–369, 2011.
- 900 [32] E. J. van Leeuwen and J. van Leeuwen. *Convex Polygon Intersection Graphs*, pages
901 377–388. Springer Berlin Heidelberg, Berlin, Heidelberg, 2011.