



HAL
open science

Thermometric chains for ITER superconductive magnets

J. Manzagol, A. Attard, N. Luchier, Patrick Bonnay, C. Mariette, J-M.
Poncet, F. Viargues, J. Journeaux, S. Huygen

► To cite this version:

J. Manzagol, A. Attard, N. Luchier, Patrick Bonnay, C. Mariette, et al.. Thermometric chains for ITER superconductive magnets. Fusion Engineering and Design, 2019, 10.1016/j.fusengdes.2019.01.047 . hal-01990606

HAL Id: hal-01990606

<https://hal.science/hal-01990606>

Submitted on 20 Jul 2022

HAL is a multi-disciplinary open access archive for the deposit and dissemination of scientific research documents, whether they are published or not. The documents may come from teaching and research institutions in France or abroad, or from public or private research centers.

L'archive ouverte pluridisciplinaire **HAL**, est destinée au dépôt et à la diffusion de documents scientifiques de niveau recherche, publiés ou non, émanant des établissements d'enseignement et de recherche français ou étrangers, des laboratoires publics ou privés.



Distributed under a Creative Commons Attribution - NonCommercial 4.0 International License

Thermometric chains for ITER superconductive magnets

J. Manzagol^a, A. Attard^a, N. Luchier^a, P. Bonnay^a, C. Mariette^a, J.-M. Poncet^a, F. Viargues^a,
J.-Y. Journeaux^b, S. Huygen^b.

^aUniv. Grenoble Alpes, CEA, INAC-SBT, F-38054 Grenoble Cedex 9, France

^bITER Organization, Route de Vinon sur Verdon, CS 90 040 13067 Saint Paul-lez-Durance Cedex, France

High environmental constraints are applied on the ITER magnets and therefore on their cryogenic thermometric chains. Accurate and reliable temperature measurements of the ITER magnets and their cooling circuits is of fundamental importance to make sure they operate under well controlled and reliable conditions. Therefore, thermometric chains shall reach a high operation reliability. In this paper, we present the full thermometric chain installed on the ITER magnets and their helium piping as well as the associated components production.

The thermometric chain is described from the signals conditioning electronics, to the sensor and its on-pipe assembly. The thermometric block design is based on the CERN's developed one for the LHC, which has been further optimized thanks to thermal simulations carried out by CEA to reach a high quality level for an industrial production. The ITER specifications are challenging in terms of accuracy and call for severe environmental constraints, in particular regarding irradiation level, electromagnetic immunity and distance between the sensors and the electronic measuring system. A focus will be made on this system, which has been recently developed by CEA. It is based on a lock-in measurement and amplification of small signals, and provides a web interface and a software to monitor and record the temperatures. This measuring device provides a reliable system for resistive temperature sensors between a few ohms and 100 kOhms.

During last two years, around 2600 thermo-blocks and nearly 50 crates of five boards, with eight channels each, have been produced and tested at CEA low temperature laboratory. All these developments and tests have been carried out thanks to three test benches built up at CEA Grenoble and in one industrial electronics laboratory. Test benches results on the entire production are presented.

Keywords: cryogenics, thermometric chain, thermometers, electronic conditioner, EMC, industrial production.

1 Introduction

Safe operation of large Nb₃Sn magnets in the range of 4K requires a precise and reliable liquid helium temperature measurement. Among the superconducting tokamaks, ITER reach certainly the highest complexity and magnetic fields, which require high-level technical specifications. ITER thermometric chain has to manage severe environmental constraints from vacuum and cryogenic conditions to high radiation and high EMC (electromagnetic compatibility) levels. The low-level signal (few mV and μ A @4K) has to be carried out the \varnothing 29m cryostat via several feeders, which leads to a 350m long chain to be available for the CODAC (Control, Data Access and Communication) system. The "Thermometric chain" section (2) describes the thermometric chain from the conditioner to the thermo-block support. The "Industrial productions" section (3) presents the production of each components and the "Test results" section (4) presents the test benches results. Section 5 summarizes the achieved work.

2 The thermometric chain

The thermometric chain is describe from the electronic conditioner to the thermo-block support.

2.1 The electronic conditioner

The conditioner (Fig. 1) used the CEA/SBT developed board, dedicated to cryogenic and fast transient temperatures measurements; the CABTR (Centrale d'Acquisition Basses Températures Rapide). It provides a low power dissipation (2.5nW@10k Ω or ~2K for CX1050 CERNOX™ sensor) and for various type of resistive sensors, thanks to a switching excitation system [1] from current to tension source depending on the resistance range. A synchronous low-level signal detection or lock-in measurement and amplification allows an electronics noise reduction and enable the extension of the chain length up to 350m as required by the IO (ITER Organization). Its bandwidth can be raised up to 100Hz depending on chain length and cables linear capacitances (<130pF/m). The eight dedicated channels of each board are available for a PLC (Programmable Logical controller) via an Ethernet fieldbus (Modbus TCP and Profinet IO). The CABTR allows uploading via a web interface and dedicated software of the calibration

Author's email: jean.manzagol@cea.fr

data of all main available sensors. An external device can be plugged to the CABTR to make a self-diagnostic and a calibration against standard resistances and so to detect any malfunction or degradation. The CABTR



Fig. 1: ITER's 19" crate with five CABTR boards (40 channels)

2.2 The cables and the feedthroughs

The whole chain (Fig. 2) is composed of four cable sections, two electrical feedthroughs and a patch panel. On Fig. 2, "Red" cables are single channel single shielded one and attached to the thermo-block, when "Blue" cables are 10 channels cable respectively single shielded in the cryostat and double shielded outside the cryostat. The cryostat entrance feedthroughs (300K) are mounted on DN160 flanges when the vacuum barrier feedthroughs (80K) are mounted on single DN40 flanges (Fig. 3). All are equipped with connectors on both side, mounted on the 10 channels cables. The cable shield connecting systems provide a sound 360° connection on all connectors, terminal blocks and on the patch panel to reach IO's EMC technical specifications.



Fig. 3: 300K feedthroughs from the production (left) and 80K feedthrough prototype with its connectors (right)

2.3 The thermometric block

Based on CERN's design [2], the thermo-block is composed of a double sided PCB (Printed Circuit Board) counter glued on a thick copper heat sink, split in three parts to intercept the heat load (Fig. 4). A cavity, machined in the third heat sink received the sensor of which the leads are soldered on thermalizing circuit of the PCB. The sensor is then encapsulated into epoxide resin. All on shelves, available sensors can be integrated in this cavity. A thermo-mechanical shield protects the whole component from 80K radiation (Fig. 5).

2.4 The support of the thermo-block

reaches an electronic accuracy of 0.01% of the resistance, which gives 0.3mK @4.2K (with CX1050 Lake Shore sensor).

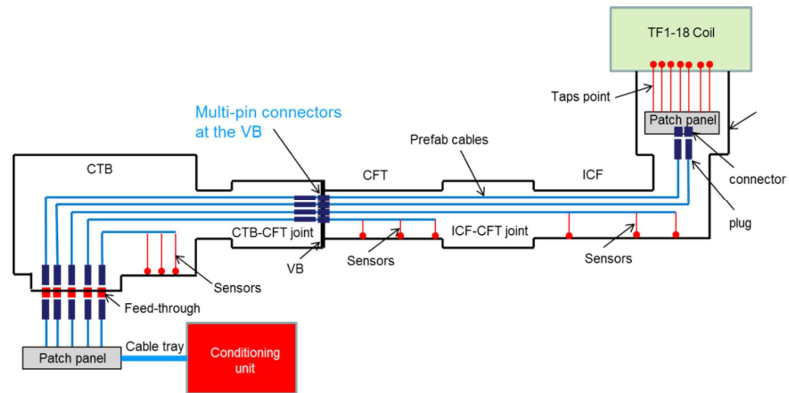

Fig. 2: ITER nominal chain structure; here for TF1-18 coils and associated feeder

To avoid any weakness on the barrier between the vacuum and the cryogen, the IO chose to implement the coolant temperature measurement from the outside of the pipe (Fig. 6). The thermo-block support is made of copper T shaped pieces also split in three parts for the same thermal reason as for the thermo-block heat sinks.

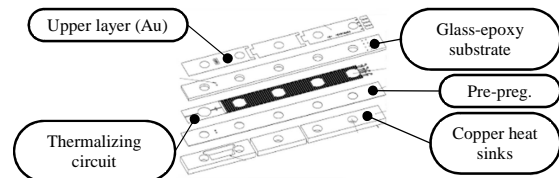

Fig. 4: PCB stack-up details

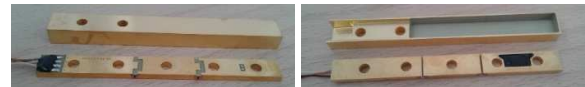

Fig. 5: Top (left) and bottom (right) sides of the thermo-block and its shield

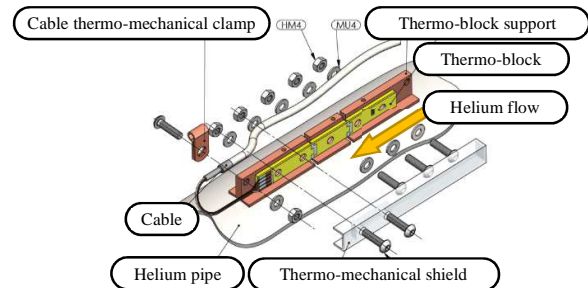

Fig. 6: Over all assembly of a thermo-block on a SST pipe

Results of CEA modeling [3] shows that the thermal anchoring of the copper blocks on the pipe is of premium importance to minimize the temperature measurement error. The copper blocks are therefore oven vacuum brazed onto the SST pipe. To ease the support brazing and/or the SST pipe welding on ITER pipe work, the support is axially symmetrical and the thermo-block can be mounted in both direction.

2.5 Specification of the thermometric chain

In this section, we explain the main specifications of the cryogenic measuring chains for magnet structures,

coils and helium pipes, and for the thermal shield of the feeders. For monitoring the operating margin of the magnets, the most accurate thermometric block should provide the following accuracy, with a 10mK resolution below 100K:

- $\pm 0.1\text{K}$ from 4.2K to 10K,
- $\pm 0.3\text{K}$ between 10K and 80K,
- $\pm 1\text{K}$ above 80K.

Moreover, severe environmental conditions, in terms of magnetic field, vacuum, radiation and EMC are to be considered. A radiation level of 5MGy integrated over 20 years has to be taken into account, and a limited sensitivity to the applied magnetic field should be guaranteed. The whole thermometric chain should withstand the cryogenic cool-downs and warm-ups of the ITER magnets as well as the IEC61000-4-4 criterion “A” standards (no signal degradation during test – 0.2mK@8K) for the EMC specification. This is assessed by ESD (Electro-static discharge) on the signal cables ($\pm 2\text{kV}$) and on the supply power cables and the cubicles grounding ($\pm 4\text{kV}$).

3 Industrial productions

The complete industrial production has been achieved in nearly two and half years from the first temperature sensors order to the last DN160 feedthroughs flange delivery. This section summarized these productions and the main difficulties encountered.

3.1 The in crate CABTR

SEICO (Nantes – France) produced the 220 boards integrated in 44 19” crates in 8 months and with very minor production defaults. The 1650 associated M12 connectors have been produced by Phoenix Contact (Blomberg - Germany). SEICO produces also ten diagnostic tools. Different CABTR configurations are

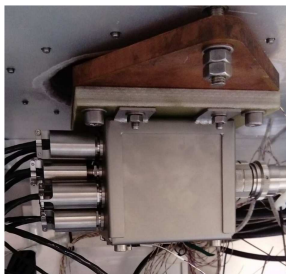

Fig. 7: Nominal patch panel mounted over hung on BETTI.

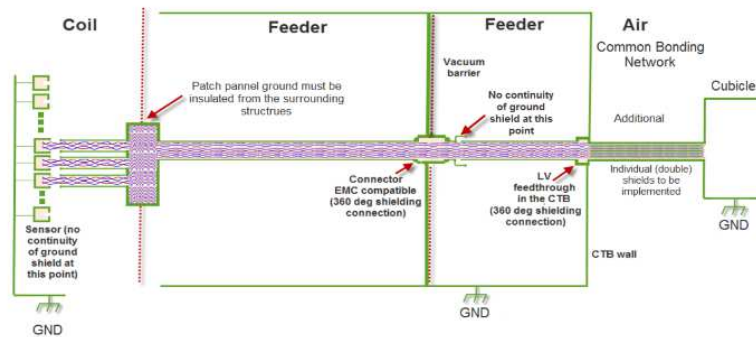

Fig. 8: Ground shield connections scheme on the T sensor cables from a coil to the cubicle



Fig. 9: Results @77K for produced thermo-blocks after five LN₂ cycles on CYTROGEN test bench - IO’s criteria: $\pm 300\text{mK}$

now commercially available and distributed by SEICO under CEA license.

3.2 The cables and the feedthroughs

Nearly 35km of single channel cable have been produced under CEA’s responsibility by AXON’Cable&Interconnect (Montmirail – France).

The 10 channels cables, for the inner and outside cryostat (~70km), first specified and tested by CEA/SBT, will also be produced by AXON but under the IO’s responsibility (2019).

After a 19 units pre-series, CONESYS Europe (Colomiers – France) produced, in 6 months, the 220 units of 10 channels feedthrough mounted on 55 DN160 flanges and the 440 associated connectors. Only one flange was presenting a leak tightness default and has been replaced.

3.3 The assembled thermo-blocks

PROTECNO-GTID (Brest – France) produced and assembled the nominal 2183 thermo-blocks unit on an overall production of more than 2600 units (prototype series and production pre-series). LAKE SHORE Cryotronics (Westerville – USA) via CRYOFORUM (Triel/Seine – France) provides the CX1050 CERNOX™ and the platinum PT103 sensors. Less than 2.6% of the thermo-blocks production has been rejected after CEA cryogenic tests and controls including the “calibration default” coming from the sensor itself.

4 Tests results

All the production has been controlled and tested at CEA laboratory on two test benches; CYTROGEN dedicated to the five thermal cycles @77K and the dielectric tests for 100% of the thermo-block production and BETTI dedicated to the control at 4.2K and 77K and to the EMC tests for 10% of all components production.

4.1 Thermometric chain behavior under EMC test on BETTI

10% of the CABTR production has been functionally tested on BETTI test bench, especially for the EMC severe specifications. The IO's thermo-block insulation specification (100V DC) and the ground shield connections scheme (Fig. 8), are coming from IO's strategy against the Eddy currents in the structure. The patch panel (Fig. 7) is therefore electrically insulated from the structures and the cable shield is not connected at the thermo-block level. Despite this specification, the entire chain responds to the IEC61000 4-4 requirement as shown on Fig. 10, where a 25mΩ peak to peak variation gives 0.2mK@8K (on a CX1050 sensor) during ESD (± 2 kV on cable shielding).

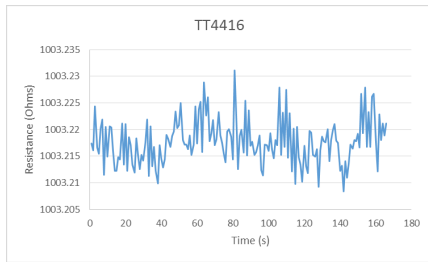

Fig. 10: Standard resistance variation during ESD on the shielding

4.2 Results after 5 cycles @77K on CYTROGEN test bench

The 2610 units were thermally cycled five time at 77K in an LN₂ bath. Fig. 9 shows CYTROGEN results for the whole production. An average gap of ± 66 mK ($\sigma=42$ mK) has been measured after five cycles at 77K and for all CERNOXTM and PT103 sensor types.

4.3 Results on BETTI test bench @4.2K

Fig. 11 shows the spread of the 105 tested thermo-blocks equipped with calibrated CERNOXTM sensor. The gap is the difference between the temperature measured by the thermo-block mounted outside a test section and the temperature of the LHe static bath inside the test section. An average gap of ± 7 mK ($\sigma=6$ mK) has been measured on the production, which is far below the IO's technical specification (± 100 mK). To minimize the overall budget, part of the thermo-blocks were equipped with un-calibrated CERNOXTM sensors (552 on 1408 overall CERNOXTM sensors).

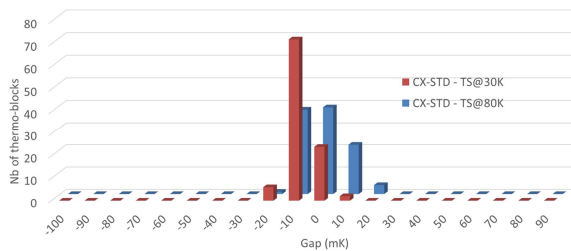

Fig. 11: Gap @4.2K between measured and reference temperature for two thermal shield temperatures and for calibrated CERNOXTM sensors (ref. CX-1050-SD-HT-1.4L).

These thermo-blocks will be mounted by pair for redundancy and calibrated against its twin-calibrated thermo-block during the first tokamak cooldowns. Fig. 12 shows the spread of the 72 tested units equipped with un-calibrated sensor.

An average gap of ± 16 mK ($\sigma=22$ mK) has been measured on the production, which is also below the IO's technical specification (± 200 mK). For this un-calibrated thermo-block an "SBT best fit" was defined among the 1032 calibrated ones, taken into account the 2 control points given by Lake Shore (4.2K and 77K).

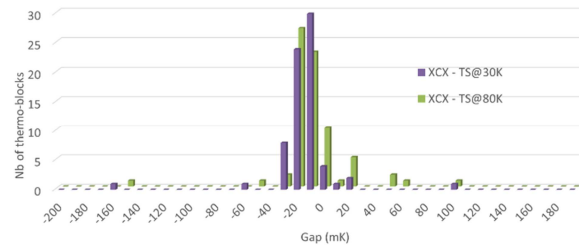

Fig. 12: Gap @4.2K between measured and reference temperature for two thermal shield temperatures and for un-calibrated CERNOXTM sensors (ref. XCX-1050-SD-HT-376).

5 Conclusion

With an entire production under QA records, CEA/SBT provides the IO with a complete, reliable and industrial thermometric chain with the specification of all associated components taken into account the severe environmental conditions.

The SBT electronic industrial sensor conditioner provides a low-level signal recording for long distance chain. It could be used on many other cryogenic applications on ITER and on others high sized physical instruments.

The views and opinions expressed herein do not necessarily reflect those of the ITER Organization

Acknowledgments

The authors thank A. Girard, A. Devred, N. Mitchell and F. Rodriguez-Mateos, for their implication during the project build-up and S. Guillaume, A. Delattre, L. Bizel-Bizelot, R. Desbuisson, J. Cezkowski, T. Jourdan, F. Bancel, G. Marzo, P. Saint-Bonnet and the industrials for their technical support and their strong commitment during the project.

References

- [1] Patent: "Method for managing a current or voltage supply of a resistive temperature sensor arranged inside a cryostat". FR3016036 – 2015-07-03 (BOPI 2015-27).
- [2] C. Balle, J. Casas, "Industrial type cryogenic thermometer with built-in heat interception", Adv. Cryog. Eng. 41, (1996).
- [3] Poncet, J.-M.; Manzagol, J.; Attard, A.; Luchier, N. Materials Science and Engineering, Volume: 171 Issue 1 (2017)