



**HAL**  
open science

## Heat pumps for simultaneous heating and cooling

Paul Byrne, Redouane Ghouali, Ahmadou Tidiane Diaby

► **To cite this version:**

Paul Byrne, Redouane Ghouali, Ahmadou Tidiane Diaby. Heat pumps for simultaneous heating and cooling. Heat Pumps: Performance and Applications, 2018. hal-01990466

**HAL Id: hal-01990466**

**<https://hal.science/hal-01990466v1>**

Submitted on 23 Jan 2019

**HAL** is a multi-disciplinary open access archive for the deposit and dissemination of scientific research documents, whether they are published or not. The documents may come from teaching and research institutions in France or abroad, or from public or private research centers.

L'archive ouverte pluridisciplinaire **HAL**, est destinée au dépôt et à la diffusion de documents scientifiques de niveau recherche, publiés ou non, émanant des établissements d'enseignement et de recherche français ou étrangers, des laboratoires publics ou privés.

*Chapter*

## **Heat pumps for simultaneous heating and cooling**

*Paul Byrne\**, *Redouane Ghouali*, *Ahmadou Tidiane Diaby*

Laboratoire de Génie Civil et de Génie Mécanique, Université de Rennes, Rennes, France

### **ABSTRACT**

Thermal demands of many buildings and industrial processes involve heating and cooling, simultaneously or slightly delayed. The typical example is the sport centre comprising a swimming pool and an ice rink. The ambient air and the water of the swimming pool have to be heated while the ice rink has to be cooled. Other examples of simultaneous heating and cooling can be found in office or residential buildings for server room cooling, indoor air heating and cooling and domestic hot water production. The food industry also often necessitate to cool the products and to wash workbenches with hot water.

Heat pumps are able to transfer heat from a heat source to a heat sink using mechanical work. They can produce simultaneously heating and cooling energies to carry out energy savings. The question is how far can we take benefit of this asset?

This chapter first presents the major situations where heating and cooling demands could occur simultaneously and could be satisfied by heat pumps. The heat pump performance expressed in terms of coefficient of performance and exergy efficiency is then presented for the subcritical vapour-compression thermodynamic cycle. Finally, the integration of such systems in buildings and processes is discussed.

**Keywords:** simultaneous demand, heating, cooling, domestic hot water, desalination

## 1. INTRODUCTION

Global warming is one of the actual major concerns. Energy savings should be accomplished in every sector. The building sector is one of the major consumers accounting for around 40 % of energy consumption and 25 % of greenhouse gas emissions of developed countries [1]. Heat pumps are efficient and reliable devices to heat and cool useful media. When equipped to do so, they can also produce simultaneously heating and cooling energies to help reduce the global energy consumption of buildings.

However, in some cases, the simultaneity of heating and cooling is not as frequent as desired. A simultaneity factor is defined to evaluate the interest of the use of a special heat pump for simultaneous heating and cooling (HPS). It is calculated for different building types demanding energy for space heating, space cooling and domestic hot water (DHW) production.

The heat pump instantaneous performance is considerably improved if the heating and cooling energies are recovered at the same time. The seasonal performance that integrates periods of simultaneous operation and only heating or only cooling is improved according to the simultaneity factor. Energy and exergy performance factors are subsequently detailed in the next section.

Finally, some applications involving simultaneous demands for heating and cooling satisfied by heat pumps are presented. The presentation relies on real systems, experimental demonstrators and simulation results. This book chapter is a compilation of our previous works in the field and of complementary results from the literature.

## 2. SIMULTANEOUS HEATING AND COOLING DEMANDS

Because of the evolution of thermal regulations in Europe, building envelopes have improved conducting to the decrease of heating needs. Besides, more surface areas for glazings and the increase of heat gains by electrical equipment increase global air-conditioning demands. Isaac et al. projects a 72 % increase of cooling energy demand from the year 2000 to the year 2100 due to climate change [2]. In residential buildings of mild climate regions, the demand for cooling energy now catches up the heating demand.

The topic of simultaneous heating and cooling was studied in the Annex 48 of the ECBCS programme (Energy Conservation in and Community Systems) of the IEA (International Energy Agency) [3]. The title of the annex is "Heat Pumping and Reversible Air Conditioning". This document highlights that some buildings present simultaneous or slightly delayed heating and cooling demands. Possible solutions to satisfy these demands for office buildings and health care institutions using heat pumping technology are detailed. An external source or sink is required because of the frequent unbalance of heating and cooling demands. Report R2 presents the different possible media usable as a heat sink or heat source [4]. They cite: outdoor air, ventilation air, ground water, surface water, a closed water loop inside the building for heat transfer, waste water, condensing water from cooling towers or refrigeration systems, ground closed loops, direct expansion ground heat exchangers, solar collectors and process heat or exhaust products.

A hot and/or cold storage system is also necessary to ensure longer operating times in the simultaneous mode to the heat pump. With a storage, the simultaneity factor presented hereafter will enhance.

## 2.1. RATIO OF SIMULTANEOUS NEEDS

Ghoubali et al. presented the simultaneity factor in one of our previous publications [5]. It is named RSN, standing for Ratio of Simultaneous Needs in heating and cooling. Equation (1) calculates the RSN on a 24-hour period. It is defined as the minimum ratio between cooling demand and total heating demand including space heating and DHW production. The 24-hour integration time implies that DHW, space heating and space cooling storage tanks are implemented. Therefore, the energy is produced as much as possible every day by the heat pump in operated a simultaneous mode.

$$RSN_{daily} = \min \left( \frac{\sum_{24h}(Q_c)}{\sum_{24h}(Q_h + Q_{DHW})}, \frac{\sum_{24h}(Q_h + Q_{DHW})}{\sum_{24h}(Q_c)} \right) \quad (1)$$

The average RSN over the year allows to identify which buildings demand more simultaneous heating and cooling energies with:

- $RSN_{yearly} = 0\%$  corresponding to no simultaneous needs,
- $RSN_{yearly} = 100\%$  corresponding to perfectly matching simultaneous needs in heating and cooling every day of the year.

Some complementary simulations taught that if the integration time is taken shorter, meaning that the system uses smaller thermal storage tanks or no storage, the yearly RSN decreases dramatically. One can conclude that well-sized storage tanks are required for this type of heat pump for simultaneous heating and cooling in the building application.

## 2.2. SPACE HEATING, DHW PRODUCTION AND SPACE COOLING

The high performance of the HPS strongly depends on the simultaneity ratio. The energy demands of three types of buildings were studied using TRNSYS software: a low-energy building, an office building and a retail store [5]. Figure 1 shows isometric views of the three buildings modeled using the 3D module of TRNSYS. The parallelepipeds placed in front of the windows correspond to shading masks.

- (a) Highly insulated residential buildings: cooling becomes sometimes necessary to address the problem of overheating during the hot season and DHW needs also exist.
- (b) Highly glazed office buildings: rooms facing north (in the northern hemisphere) receive less solar gains than rooms facing south. In addition, solutions of “cloud computing” or server rooms in office towers require large cooling needs throughout the year and heating needs during winter in some other parts of the building.
- (c) Retail stores: some stores require space heating and food cooling systems.

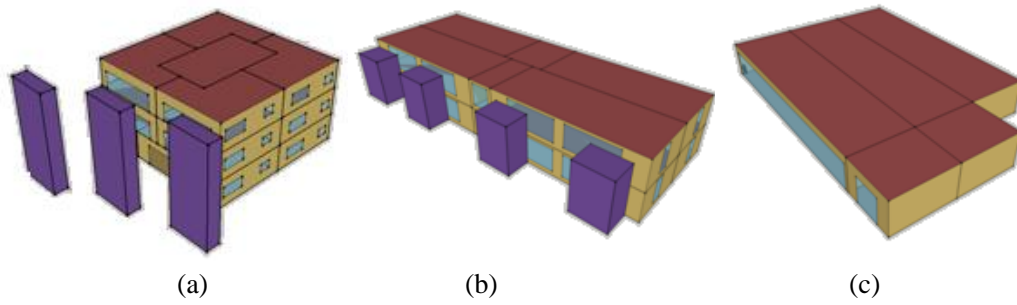

Figure 1. 3D view of residential building (a), office building (b) and retail store (c)

Table 1 presents the characteristics of the simulated buildings with occupation scenarios and assumptions on lighting and electrical equipment. The floor areas were estimated to obtain thermal heating and cooling powers that fit to the heating and cooling capacity of around 20 kW. The number of zones depends on the use and the orientation of each room. The internal gains were simulated assuming that the total heat gain was a multiple of pieces of equipment having the power of a standard personal computer (230 W). The walls of office and residential buildings have a U-value of  $0.112 \text{ W}\cdot\text{m}^{-2}\cdot\text{K}^{-1}$ , which corresponds to a high level of insulation. The U-value of the retail store walls is  $0.217 \text{ W}\cdot\text{m}^{-2}\cdot\text{K}^{-1}$ . The windows of all buildings are low-emissivity and argon-filled double glazings. They have the low heat transfer coefficient of  $U_w = 1.5 \text{ W}\cdot\text{m}^{-2}\cdot\text{K}^{-1}$ .

Table 1: Characteristics of the studied buildings [5]

Building type	Floor area (m <sup>2</sup> )	Number of thermal zones	Number of people	Occupation Scenario		Lighting (W/m <sup>2</sup> )	Number of pieces of equipment of 230 W
				Week days	Weekend		
Low-Energy Building	675	15	24	6h-9h 18h-24h	6h-24h	5	64
Office building	792	12	123	8h-20h	No occupation	10	141
Retail store	1467	5	134	8h-21h	Saturday 8h-21h	10	9

The buildings were simulated using the multi-zone building TYPE 56 of TRNSYS software to assess the thermal demands for space heating, space cooling and DHW production. The weather data files of three French cities (Rennes, Marseille and Strasbourg) were used. The following thermal demands for domestic hot water were assumed:

- Low-energy residential building: 40 litres per day and per resident at 60 °C [6]
- Office building: 5 litres per day and per employee at 60 °C [7]
- Retail store: 10 litres per day and per person at 45 °C [6]

The simulation results of daily RSN for a low-energy residential building, an office building and a retail store are presented in figure 2 using the weather data files of a typical year in Rennes (France). Due to French thermal regulation RT2012, DHW represents the major part of the building's thermal demand. DHW is merely constant over the year (just depending on the cold-water temperature). The demands for cooling and DHW during

summer are comparable. For the other two buildings, higher RSN values are achieved during mid-seasons. Table 2 summarizes the yearly RSN values for oceanic, mediterranean and continental climates. Following these simulations, residential and office buildings are interesting buildings for a HPS.

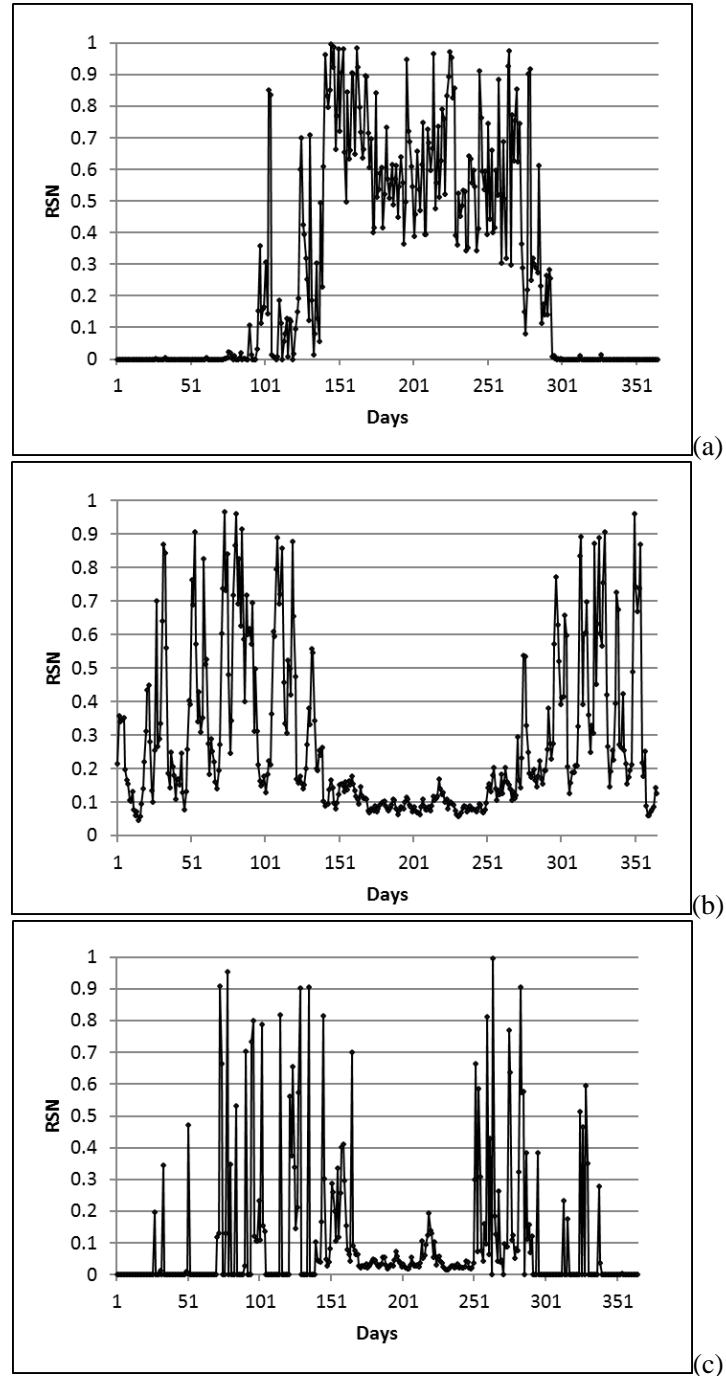

Figure 2: Evolution of RSN in a low-energy residential building (a), an office building (b) and a retail store (c) in Rennes [5]

Table 2: Yearly RSN [5]

<b>Building type</b>	<b>Low-Energy Building</b>	<b>Office building</b>	<b>Retail store</b>
Rennes (oceanic)	28.00%	28.17%	10.17%
Marseille (mediterranean)	30.52%	24.37%	10.26%
Strasbourg (continental)	22.50%	22.57%	6.86%

Higher RSN values are obtained for the residential and the office buildings that are well insulated. The RSN as a function of the insulation level was simulated with TRNSYS for a hotel of 45 bedrooms in Rennes. The building is described in a previous publication [8]. The DHW demand corresponds to 40 litres per day and per person at 60 °C. The hotel was supposed fully occupied every day of the year by 1 person per room. The U-value of the walls and the roof is calculated for 0.1 (high level of insulation), 0.2 (medium) to 0.3  $\text{W}\cdot\text{m}^{-2}\cdot\text{K}^{-1}$  (low). Figure 3 shows that the evolutions are very similar throughout the days. However, Table 3, presenting the yearly values, shows a sensitivity to the insulation level.

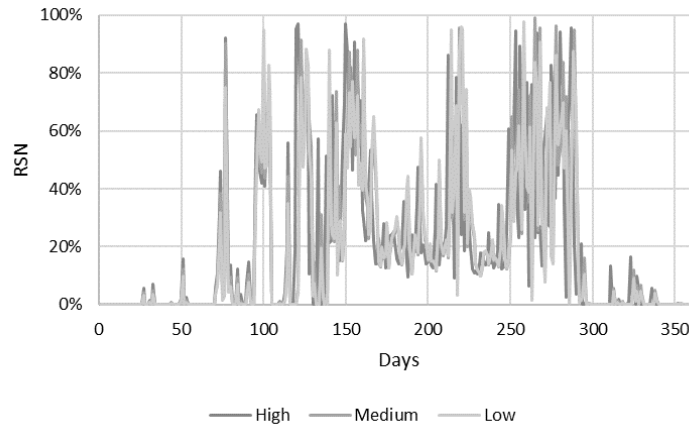

Figure 3: Evolution of RSN for a 25-bedroom hotel in Rennes

Table 3: RSN value depending on the insulation level

<b>U-value (<math>\text{W}\cdot\text{m}^{-2}\cdot\text{K}^{-1}</math>)</b>	<b>RSN</b>
0.1	20.33%
0.2	19.83%
0.3	19.26%

### 2.3. DESALINATION AND SPACE COOLING

The correlation between cooling and freshwater demands was studied for a review article [9]. In addition to climate change, water scarcity was also taken into account to put in parallel the cooling degree-days and the precipitation decrease per inhabitant of five cities throughout the world. The precipitation decrease can be seen as a possible need for desalination. The average value of cooling degree-days (CDD) for the five cities was evaluated at the value of

1930 CDD using TRNSYS weather data files [9]. According to Stocker et al. [10], climate change and precipitation decrease from 1901 to 2012 are assessed to  $+1.085\text{ }^{\circ}\text{C}$  and  $-1.85\%$ . The variations with respect to the average values are shown in Figure 4. Climate change is almost equivalent in the five cities. However, in cities where cooling degree-days have the higher values, the water scarcity is increasing more than in other cities.

This tendency sets a link between space cooling and desalination demands. Some desalination processes use heat as a driving force. Among the principal desalination processes (Table 4), membrane distillation (MD) seems the most suitable to a coupling with a refrigerating machine because it operates at temperatures compatible with the ones of the condenser of a heat pump [11].

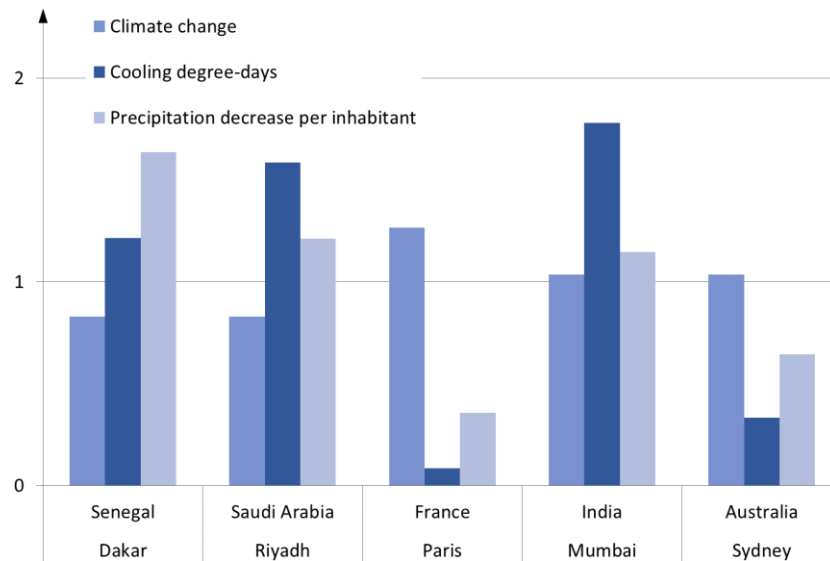

Figure 4: Relationship between relative values of climate change, cooling degree-days and precipitation decrease per inhabitant of five cities [9]

Table 4: Compatibility assessment of desalination systems with refrigerating devices [11]

Systems	Process type	Operating temperature	Compatibility with a refrigerating device
Electrodialysis	Mechanical / Membrane	Not appropriate	No
Reverse Osmosis	Mechanical / Membrane	Low influence	No
Multiple Effect Distillation	Thermal	$70\text{ }^{\circ}\text{C} - 80\text{ }^{\circ}\text{C}$	Yes, with a high temperature HP
Multi-Stage Flash distillation	Thermal	$80\text{ }^{\circ}\text{C} - 120\text{ }^{\circ}\text{C}$	No
Membrane Distillation	Thermal / Membrane	$40\text{ }^{\circ}\text{C} - 80\text{ }^{\circ}\text{C}$	Yes, with a standard HP
Thermal Vapour Compression	Mechanical / Thermal	$60\text{ }^{\circ}\text{C} - 70\text{ }^{\circ}\text{C}$	No refrigerating effect



## 2.4. SUMMARY ON SIMULTANEOUS NEEDS IN HEATING AND COOLING

Many simultaneous demands in heating and cooling exist in buildings for space heating and cooling and DHW production in mild climates. Low-energy residential buildings and office buildings are the best targets for HPSs. Their insulation level should be high to maximize the use of the simultaneous mode.

Desalination can become a usage for heat recovery of air-conditioners in hot regions. As the sales of air-conditioning units are continuously growing (to the levels of 1100 and 500 million units for residential and commercial stocks in 2016 [12]), the rejected heat that usually participate to the heat island effect in big cities could be valorised.

Many industrial processes use heating and cooling energies. The 2015 World Energy Outlook from the International Energy Agency reveals that 0.7 % of the global final energy is consumed for process cooling and refrigeration whereas 12.6 % is consumed for process heat [13]. The 0.7 % should be consumed to produce simultaneously cooling energy and heating energy for the lower temperature needs of processes. The same report insists on the fact that cooling energy for power plants is a specific issue linked to hydric stress. Finally, navigation is also cited as a growing sector that needs heating, cooling and freshwater.

## 3. HPS PERFORMANCE

The performance of the HPS depends on the application. In this section, the performance factors of the vapour-compression thermodynamic cycle (Figure 5) are given according to the first and second laws of thermodynamics [14].

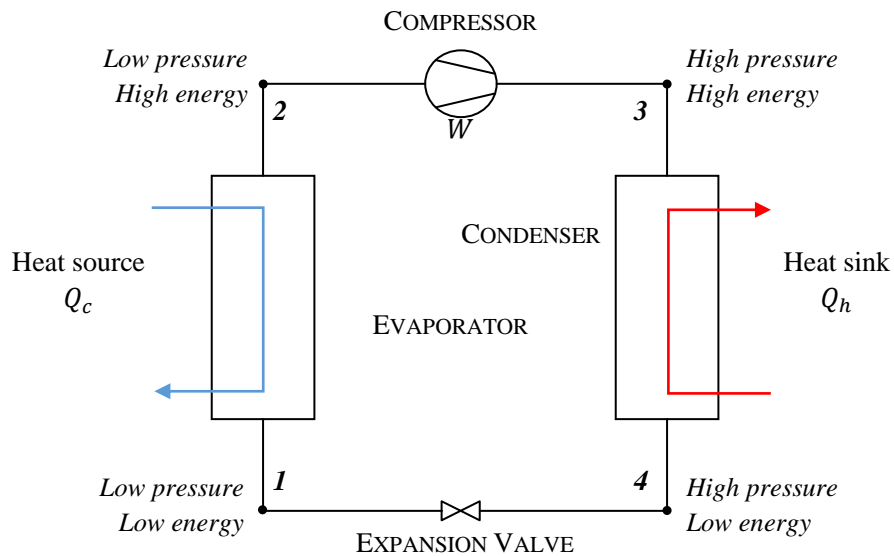

Figure 5: Vapour-compression cycle [14]

### 3.1. ENERGY PERFORMANCE

The coefficient of performance (COP) of a heat pump cycle corresponds to the useful energy produced over the mechanical work or with an instantaneous viewpoint, to the useful thermal capacity over the mechanical power. For a space-heating heat pump or a heat pump water heater, the useful energy is the heating energy (equation (2)). For a chiller or an air-conditioner, the COP is calculated using the cooling energy (equation (3)). For a HPS, both heating and cooling energies are counted at the numerator (equation (4)).

$$COP_{heating} = \frac{Q_h}{W} \quad (2)$$

$$COP_{cooling} = \frac{Q_c}{W} \quad (3)$$

$$COP_{HPS} = \frac{Q_h + Q_c}{W} \quad (4)$$

The annual energy performance is assessed through the concept of seasonal coefficient of performance (SCOP) given in equation (5).

$$SCOP = \frac{\sum_{8760h}(Q_c + Q_h + Q_{DHW})}{\sum_{8760h}(W)} \quad (5)$$

### 3.2. EXERGY PERFORMANCE

The reverse Carnot cycle sets the performance of ideal heat pumping or refrigerating cycles. All transformations are thermodynamically reversible. Compression and expansion are isentropic and heat transfers are isothermal. Feidt presents the Carnot COP as a limit for the coefficient of performance [15]. The gap between the maximum performance and the real cycle performance can be evaluated using an exergy analysis. Exergy is a thermodynamic property defined as the maximum mechanical work available in a system referring to a specified environment temperature [16]. No exergy is destroyed during a reversible process. Real processes are irreversible ones because there are always heat losses or pressure drops that correspond to friction. For refrigeration cycles, the specific exergy of a fluid at any state is given by equation (6), where  $h_0$ ,  $T_0$  and  $s_0$  are respectively the reference values of specific enthalpy, temperature and specific entropy. The exergy rate during a transformation of the refrigerant circulating in a refrigeration circuit with a mass flow rate  $\dot{m}$  is given by equation (7).

$$ex = (h - h_0) - T_0(s - s_0) \quad (6)$$

$$\dot{E}x = \dot{m}[(h_{out} - h_{in}) - T_0(s_{out} - s_{in})] \quad (7)$$

For heat pump cycles, exergy is used to evaluate the degree of irreversibility of the processes. The objective of an optimization study is then to minimize the exergy destruction for each component of the heat pump. To define the exergy efficiency of the complete heat pump cycle, the Carnot efficiency is used following equation (8), where  $T_0$  is commonly

taken as the ambient temperature [17] and  $\overline{T}_{so}$  corresponds to the logarithmic average of the source temperature (equation (9)). Using this form of the Carnot efficiency enables to evaluate exergy as the mechanical work ideally recoverable from an amount of thermal energy  $Q$  measured on the source side. Equation (10) considers grandeurs in instantaneous values. The difference between the exergy assessed with the thermophysical properties of the refrigerant (equation (7)) and by the measurement at the electric power input or the heat source and sink (equation (10)) corresponds to the destroyed energy during the transformations.

$$\eta_{Carnot} = \left| 1 - \frac{T_0}{\overline{T}_{so}} \right| \quad (8)$$

$$\overline{T} = \frac{T_{in} - T_{out}}{\ln\left(\frac{T_{in}}{T_{out}}\right)} \quad (9)$$

$$\dot{E}x_{th} = \dot{Q} \cdot \eta_{Carnot} \quad (10)$$

When calculated instantaneously, exergy efficiency is the ratio of the produced exergy rate over the exergy rate supplied to the system, which is the electric power consumed by the compressor (equations (11), (12) and (13)). Electric energy and mechanical work are considered as pure forms of exergy. The power consumed by the auxiliaries is also taken into account in the exergy efficiency calculation.

$$\eta_{ex-heating} = \frac{\dot{E}x_{heating}}{\dot{W}_{compressor} + \dot{W}_{auxiliaries}} \quad (11)$$

$$\eta_{ex-cooling} = \frac{\dot{E}x_{cooling}}{\dot{W}_{compressor} + \dot{W}_{auxiliaries}} \quad (12)$$

$$\eta_{ex-HPS} = \frac{\dot{E}x_{heating} + \dot{E}x_{cooling}}{\dot{W}_{compressor} + \dot{W}_{auxiliaries}} \quad (13)$$

For desalination systems, the exergy rate of a water flow (subscript w) is defined by equation (14). The chemical specific exergy enables to take into account the amount of salt that could be contained in the water.

$$\dot{E}x_w = \dot{m}[(h - h_0) - T_0(s - s_0) + e_{ch}] \quad (14)$$

The exergy efficiency of the HPS for simultaneous cooling and desalination is assessed by equations (15) and (16) depending on the definition of useful energy and water flows. The economical exergy efficiency divides the useful thermal and freshwater productions by the inputs to the system that have to be payed. The process exergy efficiency integrates all inputs and outputs considering that all streams have a potential value or price, such as the brine (subscript sw,out) that could be reused. The electric exergy rate refers to the air-conditioner including auxiliaries and the pump refers to the seawater pump.

$$\eta_{ex,eco} = \frac{\dot{E}x_{th} + \dot{E}x_{w,out}}{\dot{E}x_{elec} + \dot{E}x_{pump}} \quad (15)$$

$$\eta_{ex,pro} = \frac{\dot{E}x_{th} + \dot{E}x_{w,out} + \dot{E}x_{sw,out}}{\dot{E}x_{elec} + \dot{E}x_{pump} + \dot{E}x_{sw,in}} \quad (16)$$

## 4. APPLICATIONS

This section details the previous works carried out in our laboratory and other applications studied in the field of research on simultaneous heating and cooling. It tries to be exhaustive. The authors apologize if all research works have not been identified in that field. The results are classified into three categories: (1) heating and cooling for buildings including DHW production, (2) simultaneous cooling and desalination and (3) other applications such as food or process industry and district heating and cooling.

### 4.1. SIMULTANEOUS HEATING AND COOLING OF BUILDINGS

A R407C experimental prototype having a heating capacity of 15 kW was designed, constructed and tested by our research team [18-19]. The experimental COP in a simultaneous mode ranged between over 5 with evaporating / condensing temperatures equal to  $-1.2\text{ }^{\circ}\text{C} / 55.3\text{ }^{\circ}\text{C}$  and near 11 with  $0.9\text{ }^{\circ}\text{C} / 31.4\text{ }^{\circ}\text{C}$  [18]. The R407C HPS behaviour was also assessed in dynamic conditions [19]. The multi-production objective of the machine implies more components. These supplementary components can generally be used to satisfy other duties in a smart way, such as defrosting. The proposed solution for defrosting is an alternation of the heating and the simultaneous mode: (1) storing energy in the cold storage during winter in a heating mode (Figure 6) and (2) using this energy as a heat source to carry on producing hot water while defrosting (Figure 7). The amount of stored energy corresponds to the subcooling capacity of refrigerant (from  $30.9\text{ }^{\circ}\text{C}$  to  $19\text{ }^{\circ}\text{C}$ , around  $20\text{ kJ.kg}^{-1}$ , in Figure 6) multiplied by the frosting phase time in the heating mode. A two-phase thermosiphon forms between the water evaporator and the frosted air evaporator helping the defrosting process that lasts several minutes. The stored energy corresponding to around  $20\text{ kJ.kg}^{-1}$  and the evaporating energy to around  $170\text{ kJ.kg}^{-1}$ , if the refrigerant mass flow rate were constant, the time ratios in heating and simultaneous modes would be 88 % and 12 %, equivalent to frosting and defrosting phases of a standard air-source heat pump. For the HPS, the operation in the simultaneous mode does not shut down the heat production during defrosting. The integrated performance during winter is thus enhanced.

The DHW production temperature is higher than the water temperature needed for space heating. In this case, the dual heat production by a heat pump should be controlled either using a priority to DHW or assisted by an auxiliary electric heater as a backup in the DHW tank. The coupling of the HPS to buildings was studied numerically. Providing high values of RSN, the residential low-energy building with the climate of Rennes was selected. Figure 8 shows the impact of hot water production temperature on the SCOP and on the part of the backup in the total electric consumption. The SCOP takes into account the DHW preproduction by the HPS up to the space heating supply temperature varying between  $32.5$  and  $57.5 \pm 2.5\text{ }^{\circ}\text{C}$ . The optimum SCOP is obtained with a hot water production temperature from  $40\text{ }^{\circ}\text{C}$  (inlet temperature) to  $45\text{ }^{\circ}\text{C}$  (outlet temperature). In low-energy buildings, the weight of domestic hot water represent more than 60 % of the total thermal needs, therefore the use of a backup decreases significantly the global performance as it can be noticed when the HPS produces hot water from  $30$  to  $35\text{ }^{\circ}\text{C}$ . Conversely, the backup part decreases down to 4 % at  $60\text{ }^{\circ}\text{C}$  but it does not counterbalance the SCOP loss of the HPS.

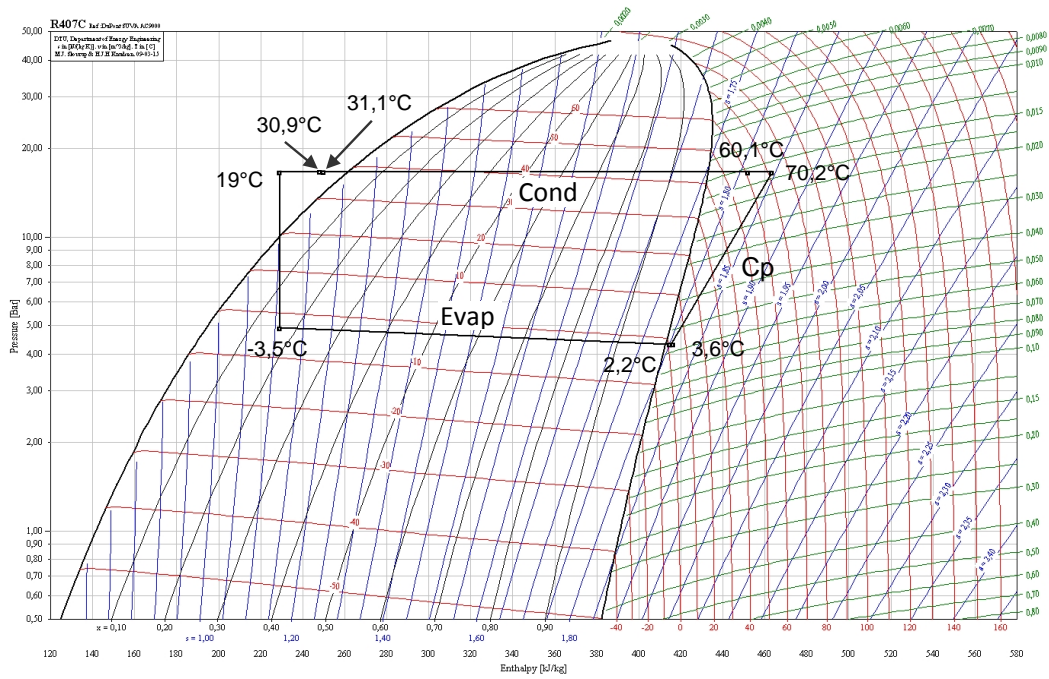

Figure 6: Thermodynamic cycle drawn with experimental measurements during a heating mode [20]

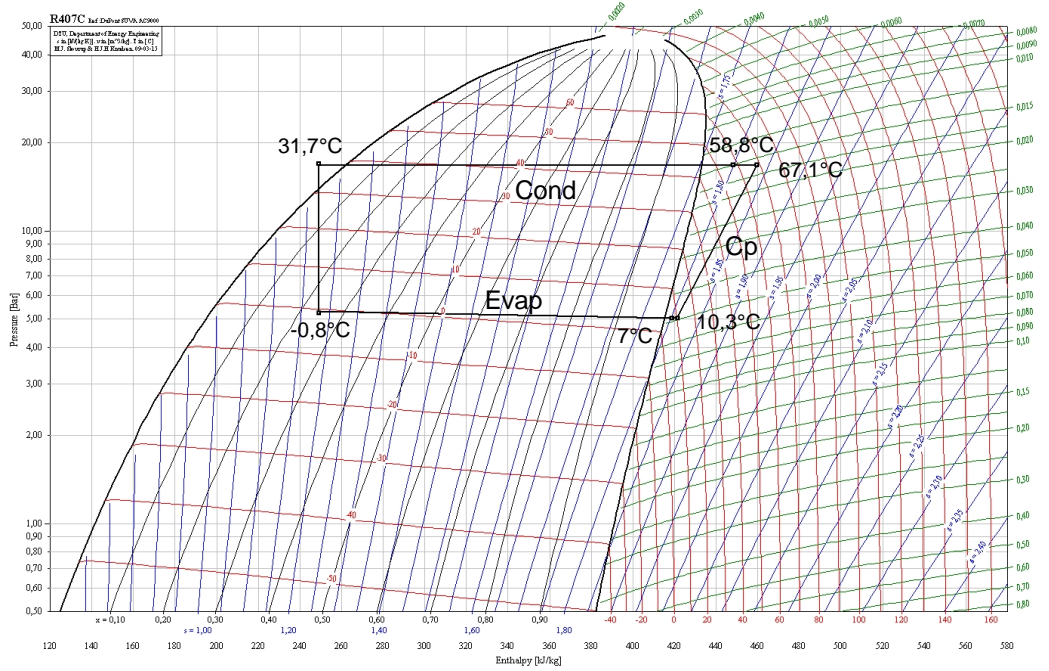

Figure 7: Thermodynamic cycle drawn with experimental measurements during a simultaneous mode [20]

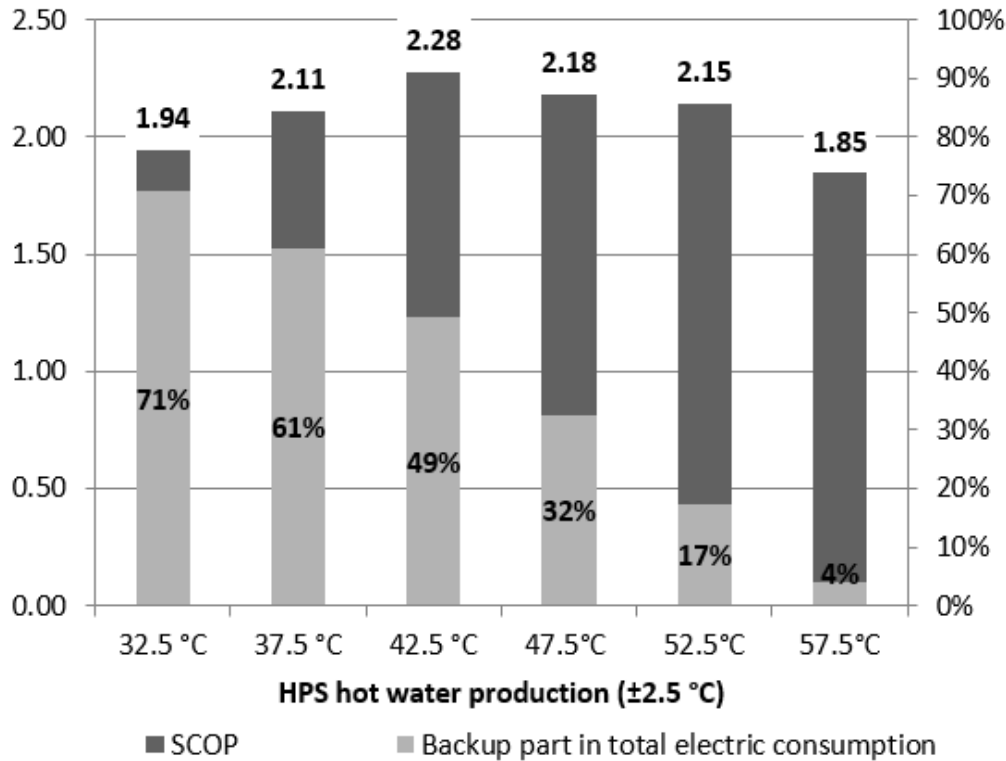

Figure 8: Impact of hot water production temperature on SCOP for a residential low-energy building [5]

The HPS was also coupled to the hotel of 45 bedrooms that is briefly described at the end of section 2.2 [8]. The hotel has heating and cooling thermal demands. In this study, the DHW is entirely produced by the HPS. The performance of the HPS is compared to the one of a standard heat pump having the same heating capacity in the heating mode and the same cooling capacity in the cooling mode. An electric backup is used for DHW production during summer for the standard reversible heat pump, which is assumed to be switched in a cooling mode. Table 5 shows the following annual performance factors:

- the annual heat pump COP defined as the total useful thermal energy produced by the heat pump (only) divided by the total electric energy consumed by the heat pump (only);
- the annual system SCOP defined as the total useful thermal energy produced by the heat pump and the electric backups divided by the total electric energy consumed by the heat pump and the electric backups;
- the exergy efficiency is the average exergy efficiency weighted by the thermal energy over a year of simulation.

Table 5 shows that the HPS has globally a higher performance than the standard reversible heat pump. The performance is globally higher than in figure 8 because of the building type. The hotel is a standard building (complying with French thermal regulation RT2005, not a low-energy building) that has a higher heating demand. The heat pump works during longer times at lower condensing temperatures, so with higher COP. The switch in a cooling mode of the standard heat pump during winter reduces dramatically the system

SCOP. Heat pump COP and exergy efficiency record the highest improvement in Brussels, where the climate is colder during winter. Using the winter alternating sequence between heating and simultaneous modes, the HPS works on average with a higher COP.

Table 5: Performance factors of heat pumps depending on the site [8]

Machine	Site	Heat pump COP	System SCOP	Exergy efficiency
HPS	Rennes	4.34	3.80	36 %
Standard HP		3.84	1.64	31 %
HPS	Marseille	5.33	4.76	33 %
Standard HP		5.02	1.99	31 %
HPS	Brussels	3.61	3.44	36 %
Standard HP		3.04	1.59	23 %

Many other authors work on such systems for simultaneous production in various applications. Chua et al. [21] evocate a significant reduction of carbon footprint using improved heat pumps for heating and cooling. Liu and Hong [22] compare ground source heat pumps to variable refrigerant flow systems, both able to provide heating and cooling energies to four perimeter zones and one core zone of a simulated small office building. Gong et al. [23] present an air-conditioning/heat-pump system recovering heat for domestic hot water production. A prototype of 7 kW cooling capacity was constructed. Its coefficient of performance reached the value of 6. Dong et al. obtained an integrated energy performance of 4.32, which was 1.58 times higher than the standard system [24]. They also proved that the refrigeration circuit is a robust network that can be quite easily modified to satisfy other demands. Fatouh and Elgendy have developed a prototype of water-to-water heat pump using R134a as a refrigerant achieving a maximum COP of 4.9 [25]. Corberan et al. worked on a dual source heat pump with a simultaneous mode [26]. This plug-and-play system for existing buildings has a full recovery mode allying DHW production and cooling. However, this mode was not used very often because the demand of the studied building was very separate between summer and winter. Nevertheless, due to simultaneous heating and cooling, energy can be saved and installation cost of equipment can be reduced compared to two uncoupled systems [27]. HPSs or heat pumps with heat recovery seem commercially adapted to collective buildings with thermal demands from around 50 kW. Some companies start to propose heat pumps for simultaneous heating and cooling for commercial and office buildings [28]. Heat recovery also becomes a major issue for manufacturers [29].

## 4.2. SIMULTANEOUS COOLING AND DESALINATION

Some desalination systems consume heat to produce freshwater. A simulation study was carried out by our research team on this topic [30]. It evaluates the performance of a heat pump coupled to an air gap membrane distillation unit (Figure 9). Water vapour is vaporised because of a vapour pressure gradient between the hot channel and the condensation channel. The vapour pressure gradient is created by the temperature difference between hot and cold fluids. Vapour transfers through a microporous and hydrophobic membrane and condenses on a cold plate. Seawater is pumped to enter the cold channel and to cool the cold plate. The heat rejected by the heat pump is transferred to the seawater after the recovery heat exchanger

(heat gain in Figure 9). The recovery heat exchanger preheats the seawater with the heat contained in the brine.

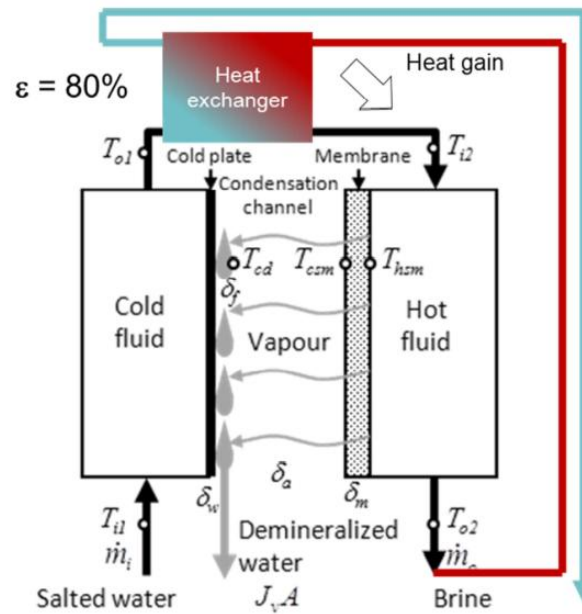

Figure 9: Scheme of air gap membrane distillation system [30]

A comparison of the HPS for cooling and desalination with the association of a chiller and a reverse osmosis desalination plant is proposed for the climate of Dakar, Senegal (Figure 10). The annual electricity consumption and the freshwater production depend strongly on temperature  $T_{i2}$  of the seawater entering the hot channel. If the source temperature is high, the HPS consumes more than the chiller because the condensing temperature is higher than the average one of the air condenser of the chiller. For that amount of freshwater production, the electricity consumption of the reverse osmosis unit is negligible compared to the one of the chiller. Conversely, the freshwater production increases with the temperature difference that drives the vapour transfer inside the MD unit.

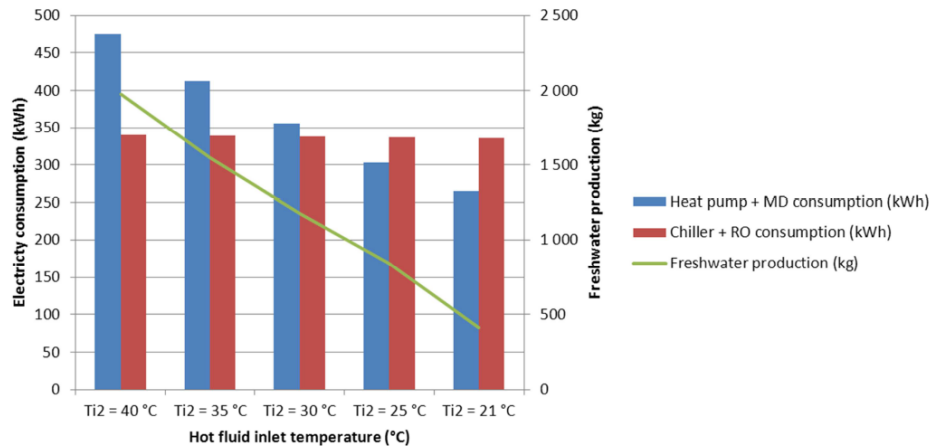

Figure 10: Comparison between a heat pump for simultaneous cooling and desalination and the association of a chiller and a reverse osmosis desalination system [30]



Diaby et al. performed an exergy analysis on a system for simultaneous air-conditioning and freshwater production [11]. Table 4 shows the detailed results of exergy rates and economical and process exergy efficiencies for two operating scenarios.

Scenario 1 simulates a continuous operation through an open loop. The desalination system (same principle as in Figure 9) is assumed to be connected to an infinite seawater volume. The brine is directly discharged to the sea. The inlet temperature of the cold channel is considered constant for a given test.

Scenario 2 corresponds to a batch mode that can be used in rural areas. A tank is assumed to be filled up regularly with a new amount of seawater or brackish water. An initial tank volume of 100 L is assumed acceptable considering a daily filling-up. The dynamic model using Engineering Equation Solver [31] was useful because the salt concentration, the temperature and the mass of the tank evolve with time.

The exergy rate of the seawater pump is considered constant and equal to 50 W for Scenario 1 and 5 W for Scenario 2. Scenario 1 supposes to pump the seawater from the sea. Therefore, the pipe length and the pressure drops require a more powerful pump. In both scenarios, the process exergy efficiency including exergy amounts from feed seawater and brine increases progressively as  $T_{il}$  (in Scenario 1) or  $T_{tank}$  (in Scenario 2) increases. However, the higher exergy efficiencies on an economical viewpoint are found for the higher flow rate and the lower temperatures in both scenarios. This result is mainly explained by the fact that the electric power consumed by the compressor is lower.

Table 6: Exergy analysis of individual components

Scenario	Flow rate [l/min]	$T_{il}, T_{tank}$ [°C]	$\dot{E}x_{elec}$ [kW]	$\dot{E}x_{th}$ [kW]	$\dot{E}x_{sw,out}$ [kW]	$\dot{E}x_{w,out}$ [kW]	$\dot{E}x_{sw,in}$ [kW]	$\eta_{ex,eco}$ [%]	$\eta_{ex,pro}$ [%]	
1	2	15	0.797	0.248	0.008	0.034	0.006	30.0	33.7	
		20	0.822	0.244	0.000	0.063	0.006	28.7	35.9	
		25	0.847	0.238	0.004	0.099	0.025	29.3	40.2	
		30	0.871	0.232	0.020	0.142	0.052	<b>30.8</b>	<b>45.3</b>	
	5	15	0.596	0.251	0.019	0.006	0.003	<b>39.3</b>	39.0	
		20	0.632	0.255	0.000	0.038	0.001	37.4	43.0	
		25	0.668	0.256	0.011	0.095	0.006	36.5	49.0	
		30	0.704	0.256	0.052	0.176	0.013	35.8	<b>55.3</b>	
		2	15.0	0.797	0.248	0.008	0.034	0.006	31.7	35.6
			33.8	0.889	0.227	0.040	0.180	0.081	34.4	52.1
36.0	0.899		0.223	0.054	0.203	0.100	<b>35.8</b>	54.9		
36.2	0.900		0.223	0.067	0.219	0.097	35.3	<b>55.4</b>		
5	15.0	0.596	0.251	0.019	0.006	0.003	<b>42.2</b>	41.9		
	35.6	0.743	0.254	0.129	0.293	0.026	37.5	65.5		
	38.2	0.761	0.253	0.177	0.359	0.035	37.5	68.4		
	38.6	0.764	0.253	0.185	0.369	0.035	37.4	<b>68.8</b>		

Other techniques like the crystallization method can be employed to carry out simultaneous cooling, desalination and heating [9]. According to thermodynamics, the ice formed by freezing seawater is pure. It can be subsequently melted to produce freshwater. Crystallization is known to consume low energy [32]. Absorption or adsorption chillers (discussed in the next section) can also be interesting options for higher capacities [33].

### 4.3. OTHER SIMULTANEOUS HEATING AND COOLING SYSTEMS AND APPLICATIONS

Absorption systems are promising solutions (Figure 11) [34]. The principle is based on the chemical affinity of an absorbent and a refrigerant. The two most commonly used couples are (1) water and lithium bromide (LiBr) for medium temperature cooling and (2) ammonia and water for low temperature cooling. At low pressure and low temperature, the refrigerant evaporates and produces cooling energy. The absorption of the refrigerant occurs in the absorber. Some heat is recovered in the absorber. The solution is pumped to the generator. At high temperature and higher pressure, the refrigerant is desorbed by a high temperature heat source. The refrigerant in a vapour phase is sent to the condenser to recover a second amount of heat. The weak solution (mainly absorbent) returns to the absorber.

The principle of adsorption systems is based on the chemical interaction between the refrigerant and a solid adsorbent. The adsorbent is contained into two compartments that are reversed when saturation of is obtained in one part. A high-temperature desorbing source is also needed.

Simultaneous heating and cooling with absorption or adsorption systems can become interesting if a high temperature heat source (such as waste heat or solar heat) is employed. Trigeration absorption chillers combining power, heating and cooling energies are also promising alternatives. High energy savings can be achieved [35-37]. Absorption and adsorption technologies need to be better known by the public so that the end-user would adhere to it and the installation costs would decrease.

Table 7 reports the main advantages and disadvantages of these technologies compared to the vapour-compression system.

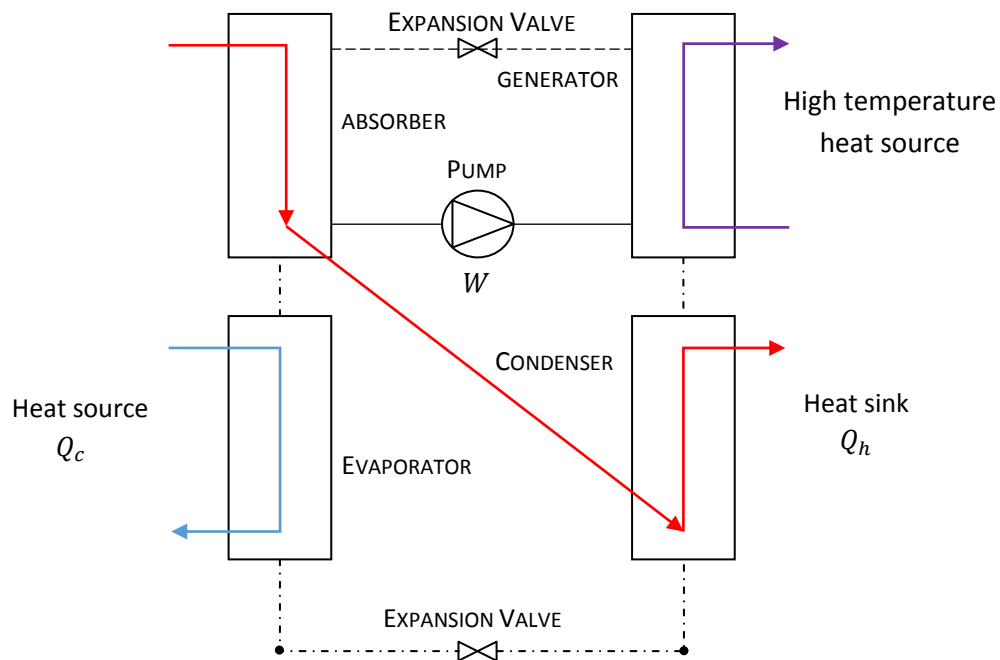

Figure 11: Absorption system cycle

Table 7: Comparison of absorption, adsorption and vapour-compression heat pumps [38]

<b>Thermal process</b>	<b>Advantages</b>	<b>Disadvantages</b>
Absorption	Noiseless Low amount of electrical energy required to operate the pump Environmental friendly refrigerant	High installation costs High temperature heat source needed Crystallization risk (if LiBr-Water is used)
Adsorption	Low operation and maintenance costs Simple construction No corrosive and environmentally friendly refrigerant No mechanical and electrical energy required	High investment costs Poor mass and heat transfer Low COP
Vapour-compression	High efficiency Low cost	Environmental impact of the refrigerant Higher amount of electrical energy required to operate the compressor

A district heating and cooling system including a heat recovery chiller was studied for high-density business areas in Japan [39]. The simulation results show 29 % of energy savings compared with the individual heat source system. Two advantages were highlighted: economy of scale in chillers/heat pumps and thermal storage effect.

Other researchers also previously studied simultaneous heating and cooling systems for special applications such as industrial processes or the food industry. Lecrivain [40] highlights the performance of a HPS that produces hot water at 95 °C and chilled water, saving energy compared to a solution allying a natural gas boiler and a cooling unit. Ghosh [41] quantified the economic benefits of a HPS for an industrial purpose. He found that with the electricity price of India, a HPS has a payback time lower than 18 months. Sarkar et al. worked on a CO<sub>2</sub> heat pump for simultaneous cooling/refrigeration and heating for process plants where heating at about 100 to 140 °C is required [17] [42]. White et al. worked on a CO<sub>2</sub> heat pump for the food industry, able to heat water up to 90 °C for cleaning, sterilisation or process heating [43]. They predicted reductions of energy cost by 33 % and of CO<sub>2</sub> emissions by 52 %.

## 5. CONCLUSIONS

The building sector is one of the major energy consumers. The demand for heating and cooling can be assessed through the ratio of simultaneous needs (RSN) defined in this chapter. Residential and office buildings often have simultaneous demands and the tendency is towards more overlapping of heating and cooling demands due to climate change and more severe requirements of thermal regulations.

Heat pumps are good solutions to produce heating and cooling simultaneously. They can save huge amounts of energy and greenhouse gas emissions. Moreover, desalination can become an important consumer of heat for hot climates. An external heat source or heat sink must be chosen to balance the productions depending on the demands. They necessitate a heat storage to improve the RSN and to become cost-competitive. The savings can even be enlarged when using the system at a district heating and cooling scale. Finally, many other applications exist in the industry and in agro-food companies. Heat pumps for simultaneous heating and cooling can valorise all of them.

## REFERENCES

- [1] Ren Z, Paevere P, Grozev G, Egan S, Anticev J. Assessment of end-use electricity consumption and peak demand by Townsville's housing stock. *Energy Policy* 61 (2013) 888-893
- [2] Isaac M., van Vuuren D.P. Modeling global residential sector energy demand for heating and air conditioning in the context of climate change, *Energy Policy* 37 (2009) 507–521
- [3] Stabat, P. Analysis of heating and cooling demands in the purpose of assessing the reversibility and heat recovery potentials, IEA EBC Annex 48 project report R1 (2011)
- [4] Bertagnolio S., Stabat, P. Review of heat recovery and heat pumping solutions, IEA EBC Annex 48 project report R2 (2011)
- [5] Ghouali R., Byrne P., Miriel J., Bazantay F. Simulation study of heat pumps for simultaneous heating and cooling coupled to buildings. *Energy and Buildings* 72 (2014) 141–149
- [6] Recknagel H., Sprenger E., Schramek E.R. Recknagel, *Manuel pratique du génie climatique : chauffage et production d'eau chaude sanitaire*, PYC Edition (1996) 222
- [7] AICVF, Association des Ingénieurs en Climatologie, Ventilation et Froid, Volume 6 : Bâtiments non résidentiels (2000)
- [8] Byrne P., Miriel J., Lénat Y. Modelling and simulation of a heat pump for simultaneous heating and cooling. *Building Simulation: An International Journal* 5 (2012) 219–232
- [9] Byrne P., Fournaison L., Delahaye A., Ait Oumeziane Y., Serres L., Loulergue P., Szymczyk A., Mugnier D., Malaval J.-L., Bourdais R., Gueguen H., Sow O., Orfi J., Mare T. A review on the coupling of cooling, desalination and solar photovoltaic systems. *Renewable and Sustainable Energy Reviews* 47 (2015) 703–717
- [10] Stocker T.F., Qin D., Plattner G.K., Tignor M., Allen S.K., Boschung J., Nauels A., Xia Y., Bex V., Midgley P.M. IPCC, 2013: Summary for Policymakers. In: *Climate Change 2013: The Physical Science Basis*
- [11] Diaby A.T., Byrne P., Loulergue P., Balannec B., Szymczyk A., Mare T., Sow O. Design study of the coupling of an air gap membrane distillation unit to an air conditioner. *Desalination* 420 (2017) 308-317
- [12] IEA/OECD. *The Future of Cooling. Opportunities for energy-efficient air conditioning.* International Energy Agency (2018)
- [13] IEA/OECD. *2015 World Energy Outlook.* International Energy Agency (2015)
- [14] Byrne P. Advances in air-source heat pump water heaters. Chapter 4 pp. 93-122 of book: *Novel Concepts for Energy-Efficient Water Heating Systems: Theoretical Analysis and Experimental Investigation.* Editor: Nova Science Publishers. Scientific editors: MSc. Douglas F. Barbin and Prof. Dr. Vivaldo Silveira Jr. January 2013
- [15] Feidt M. Thermodynamics applied to reverse cycle machines, a review. *International Journal of Refrigeration* 33 (2010) 1327-1342
- [16] Dincer I., Cengel Y.A. Energy, entropy and exergy concepts and their role in thermal engineering, *Entropy*, Vol 3 (2001), pp. 116-149
- [17] Sarkar J., Bhattacharyya S., Ram Gopal M. Optimization of a transcritical CO<sub>2</sub> heat pump cycle for simultaneous cooling and heating applications, *International Journal of Refrigeration* 27 (8) (2004) 830-838

- 
- [18] Byrne P., Miriel J., Lenat Y. Experimental study of an air-source heat pump for simultaneous heating and cooling – part 1: basic concepts and performance verification, *Applied Energy* 88 (2011) 1841-1847
- [19] Byrne P., Miriel J., Lenat Y. Experimental study of an air-source heat pump for simultaneous heating and cooling – part 2: dynamic behaviour and two-phase thermosiphon defrosting technique. *Applied Energy* 88 (2011) 3072-3078
- [20] Byrne P. Etude expérimentale et simulée d'une thermofrigopompe de petite à moyenne puissance à équilibrage sur air. PhD Thesis, INSA Rennes (2009)
- [21] Chua K.J., Chou S.K., Yang W.M. Advances in heat pumps systems: a review. *Applied Energy* 87 (2010) 3611–3624
- [22] Liu X., Hong T. A comparison of energy efficiency between variable refrigerant flow systems and ground source heat pumps. *Energy and Buildings* 42 (2010) 584–589
- [23] Gong G., Zeng W., Wang L., Wu C. A new heat recovery technique for air-conditioning/heat-pump system, *Applied Thermal Engineering* 28 (2008) 2360-2370
- [24] Dong J., Li H., Yao Y., Jiang Y., Zhang X. Experimental study on the performance of a multi-functional domestic air conditioner with integrated water heater. *Applied Thermal Engineering* 120 (2017) 393-401
- [25] Fatouh M., Elgendy E., Experimental investigation of a vapor compression heat pump used for cooling and heating applications, *Energy* 36 (5) (2011) 1-8
- [26] Corberán J.M., Cazorla-Marín A., Marchante-Avellaneda J., Montagud C. Dual source heat pump, a high efficiency and cost-effective alternative for heating, cooling and DHW production. *International Journal of Low-Carbon Technologies* 13 (2018) 161-176
- [27] Patel R.P., Kapadia R.G. Performance evaluation of a vapour compression refrigeration system for simultaneous cooling and heating by using R22 and alternative refrigerants. *International Journal of Engineering Research & Technology* 2 (2013) 1809-1815
- [28] Energie Transfert Thermique. Développement d'une gamme de thermofrigopompes au propane. *Chaud Froid Performance* 817 (2018) 40-44
- [29] Mitsubishi Electronics. VRF City Multi Product Catalogue (2016) 17
- [30] Byrne P, Ait Oumeziane Y, Serres L, Miriel J. Study of a heat pump for simultaneous cooling and desalination. *Applied Mechanics and Materials* 819 (2016) 152-159
- [31] Klein S. Engineering Equation Solver, Version 10.200-3D, ©1992-2017
- [32] Johnson WE. Indirect freezing, *Desalination* 31 (1979) 417-425
- [33] Ghaffour N, Lattemann S, Missimer T, Ng KC, Sinha S, Amy G. Renewable energy-driven innovative energy-efficient desalination technologies. *Applied Energy* 136 (2014) 1155 –1165
- [34] Settino J., Sant T., Micallef C., Farrugia M., Spiteri Staines C., Licari J., Micallef A. Overview of solar technologies for electricity, heating and cooling production. *Renewable and Sustainable Energy Reviews* 90 (2018) 892-909
- [35] Hernandez J., Sanchez-Cifuentes A. Trigeneration: an alternative for energy savings, *Applied Energy* 76 (2003) 219 – 227
- [36] Wu D.W., Wang R.Z. Combined cooling, heating and power: A review, *Progress in Energy and Combustion Science* 32 (2006) 459 – 495
- [37] Deng J., Wang R.Z., Han G.Y. A review of thermally activated cooling technologies for combined cooling, heating and power systems, *Progress in Energy and Combustion Science* 37 (2011) 172 – 203

- [38] Allouhi A., Kousksou T., Jamil A., Bruel P., Mourad Y., Zeraouli Y. Solar driven cooling systems: An updated review. *Renewable and Sustainable Energy Reviews* 44 (2015) 159-181
- [39] Nagota T., Shimoda Y., Mizuno M. Verification of the energy-saving effect of the district heating and cooling system—Simulation of an electric-driven heat pump system, *Energy and Buildings* 40 (2008) 732–741
- [40] Lecrivain E., Laroche G., Vallot A. La production simultanée d'eau glacée et d'eau chaude à 95°C par une thermofrigopompe d'une laiterie, *Revue Internationale du Froid* 5 (1982) 221-225
- [41] Ghosh S., Devotta S., Patwardhan V.S. The economics of heat pump systems for simultaneous heating and cooling, *Heat Recovery Systems* 7 (1987) 159-166
- [42] Sarkar J., Bhattacharyya S., Ram Gopal M. Simulation of a transcritical CO<sub>2</sub> heat pump cycle for simultaneous cooling and heating applications, *International Journal of Refrigeration* 29 (5) (2006) 735-743
- [43] White S.D., Cleland D.J., Cotter S.D., Stephenson R.A., Kallu R.D.S., Fleming A.K. A heat pump for simultaneous refrigeration and water heating. *IPENZ Trans* (1997) 24

---

## NOMENCLATURE

### Abbreviations

CDD	cooling degree-days
Cond	condenser
COP	coefficient of performance
Cp	compressor
DHW	domestic hot water
Evap	evaporator
HP	heat pump
HPS	heat pump for simultaneous heating and cooling
MD	membrane distillation
RSN	ratio of simultaneous needs in heating and cooling
RT	French thermal regulation (Réglementation Thermique)
SCOP	seasonal coefficient of performance

### Latin letters

$ex$	specific exergy ( $J.kg^{-1}$ )
$\dot{E}x$	exergy rate (W)
$h$	enthalpy ( $J.kg^{-1}$ )
$\dot{m}$	mass flow rate ( $kg.s^{-1}$ )
$Q$	thermal energy (J)
$s$	entropy ( $J.kg^{-1}.K^{-1}$ )
$T$	temperature (K)
$U$	heat transfer coefficient ( $W.m^{-2}.K^{-1}$ )
$W$	mechanical work (J)

### Greek letters

$\eta$	efficiency (%)
--------	----------------

### Subscripts

0	reference state
c	cooling
ch	chemical
eco	economical
ex	exergy
h	heating
pro	process
so	source
sw	seawater
th	thermal
w	window, water