



HAL
open science

Good practices and uncertainty assessment process on AACMM

Salma El Asmai, François Hennebelle, Patrick Jullion, Christophe Gabeau, Stéphane Lacaud, Renald Vincent, Patrice Maligner, Jean-François Fontaine

► **To cite this version:**

Salma El Asmai, François Hennebelle, Patrick Jullion, Christophe Gabeau, Stéphane Lacaud, et al.. Good practices and uncertainty assessment process on AACMM. 18ème Congrès International de Métrologie (CIM 2017), Sep 2017, PARIS, France. hal-01988707

HAL Id: hal-01988707

<https://hal.science/hal-01988707>

Submitted on 21 Jan 2019

HAL is a multi-disciplinary open access archive for the deposit and dissemination of scientific research documents, whether they are published or not. The documents may come from teaching and research institutions in France or abroad, or from public or private research centers.

L'archive ouverte pluridisciplinaire **HAL**, est destinée au dépôt et à la diffusion de documents scientifiques de niveau recherche, publiés ou non, émanant des établissements d'enseignement et de recherche français ou étrangers, des laboratoires publics ou privés.

Good practices and uncertainty assessment process on AACMM

Salma EL ASMAI¹, François HENNEBELLE¹, Patrick JULLION¹, Christophe GABEAU², Stéphane LACAUD², Renald VINCENT³, Patrice MALIGNER⁴, Jean-François FONTAINE¹

1: Le2i FRE2005, CNRS, Arts et Métiers, UBFC, Avenue des plaines de l'Yonne, 89000 AUXERRE

2: KREON Technologies, ESTER Technopole, 19 Rue Columbia, 87068 LIMOGES

3: CETIM, 52 Avenue Félix Louat, 60300 Senlis, 60300 SENLIS

4: Abaqsys ingénierie, 6 Route de Moneteau, 89000 Auxerre, 89000 MONETEAU

ABSTRACT

This paper presents a methodology of evaluating the performance of Articulated Arm Coordinate Measuring Machines (AACMM) for general acceptance – based on the manufacturer's specifications, and on site – based mainly on the application requirements. The first part of this paper takes stock of ISO 10360-12: 2016 standard, which defines the tests that the AACMM user should perform to validate or not the performance of his machine. The various tests recommended by the standard are analyzed and their practical usefulness is explained. In the second part of the paper, an on-site uncertainty estimation methodology is proposed. The interest of the on-site verification methodology proposed is illustrated by actual tests with different artifacts. Moreover, an Aimes Products patented innovative removable tetrahedral artifact [1], highly adapted for quick on-site verification is presented as well. The advantages and disadvantages of the commonly used length artifacts are discussed.

No one of the available AACMM standards addressed the on-site verification topic. The importance of the proposed methodology is to enable the user to assess the uncertainties in the measurement site, which may be actually different from the uncertainties of the AACMM in the optimal environmental conditions, provided by the manufacturer. The aim of the on-site verification tests is not providing an exact estimation of the uncertainty of measurement; it is rather giving an order of magnitude of the uncertainty in the site. The overall aim of these tests is to be able to detect if there are any important issues in the site and to evaluate if we are far from the required tolerance.

1 INTRODUCTION

Articulated Arm Coordinate Measuring Machines (AACMM) are portable three-dimensional measuring machines with 6 or 7 rotary axes. Their flexibility, convenience and reduced cost are among the key elements enabling these devices to fully integrate the projects of "the factory of the future". However, their uncertainty – generally of a few tens of micrometers for a measuring range of 1m50 to 4m50 – remains much larger than the uncertainty of classical three-dimensional measuring machines. Indeed, the user's manipulation and the measurement site environment contribute to amplify these uncertainties.

To help the user correctly use AACMMs and evaluate its performance, the ASME B89.4.22.2004 standard [2] specifies the environment tests and some practical performance evaluation tests, using a

kinematic seatⁱ and a ball bar. The ISO 10360-12:2016 standard [3] recently released provides a complete methodology of verification of AACMMs performance, based on comparisons with the maximal permissible errors provided by the manufacturer. In this regard, many articles have addressed the AACMM uncertainty evaluation topic. González-Madruga et al. [4] have proposed a new methodology of uncertainty evaluation based on a gauge with four virtual circles. Each circle consist of three kinematic seats. The gauge is measured in different positions in the working range of the AACMM to evaluate its performance. In the same logic, Piratelli-Filho et al. [5] have previously proposed a virtual ball bar for AACMM performance evaluation. The virtual ball bar consist of a bar containing two groups of four kinematic seats. Each group of kinematic seats is measured as a virtual sphere. Acero et al. [6] proposed in 2016 a new methodology of verification of AACMMs using a capacitive sensor indexed metrology platform (IMP) to generate unlimited number of reference lengths. This new methodology has the advantage of reducing the cost of calibration and the time and space needed for it. Cuesta et al. [7] proposed a feature-based gauge that aims to evaluate at the same time the AACMM but also the operator skills. As it is commonly known that the impact of the operator on the measurements is very important, the aim of this new method with the feature-based gauge is a better identification of the uncertainty sources (operator or AACMM).

Other authors have proposed tests for AACMMs calibration rather than their uncertainty evaluation. Santolaria et al. [8] presented a procedure of AACMM calibration and method of correction of its kinematic parameters with a gauge containing four spheres. Gao et al. [9] proposed a calibration method for robotic AACMMs based on denavit-hartenberg kinematic model for robotic systems. The approach was tested by evaluating the uncertainties with an AACMM test rig. Santolaria et al. [10] presented a methodology of AACMMs calibration based on a spherical reflector and four laser trackers, to generate virtual calibrated lengths.

This paper is organized into two parts. In the first part, we present the tests recommended by ISO 10360-12:2016 and discuss their usefulness and the interesting information that can be extracted from them. In the second part, we address the AACMM performance on-site verification by proposing adapted tests that the user can perform before starting the measurements. We differentiate between repeatability/reproducibility verification tests and general verification tests. These general verification tests are performed with length or volume artifacts. They enable the user to generally assess the accuracy (systematic error) and the precision (Random error) [11] of the AACMM in the site. This approach have been partially addressed by Romdhani et al. [12]; the paper identified these two errors (accuracy and precision) thanks to a Monte Carlo simulation on multiple levels. In this paper, we propose a test to determine the value of these errors in the measurement site.

2 TESTS RECOMMENDED BY ISO 10360-12:2016

“The standard ISO 10360-12:2016 was published in October 2016. It specifies the acceptance tests for verifying the performance of an Articulated Arm Coordinate Measuring Machine (AACMM) by measuring calibrated test lengths as stated by the manufacturer. It also specifies the reverification tests that enable the user to periodically reverify the performance of the AACMM. It applies to AACMMs using tactile probes and optionally optical distance sensors (also referred to as laser line scanners or laser line probes)” [3]. ISO 10360-12:2016 specifies also the manner of execution of the acceptance and reverification tests to demonstrate the stated requirements, the rules for proving conformance, and some applications for which the acceptance and reverification tests can be used.”

The Figure 1 below presents a summary of the recommended tests in ISO 10360-12:2016.

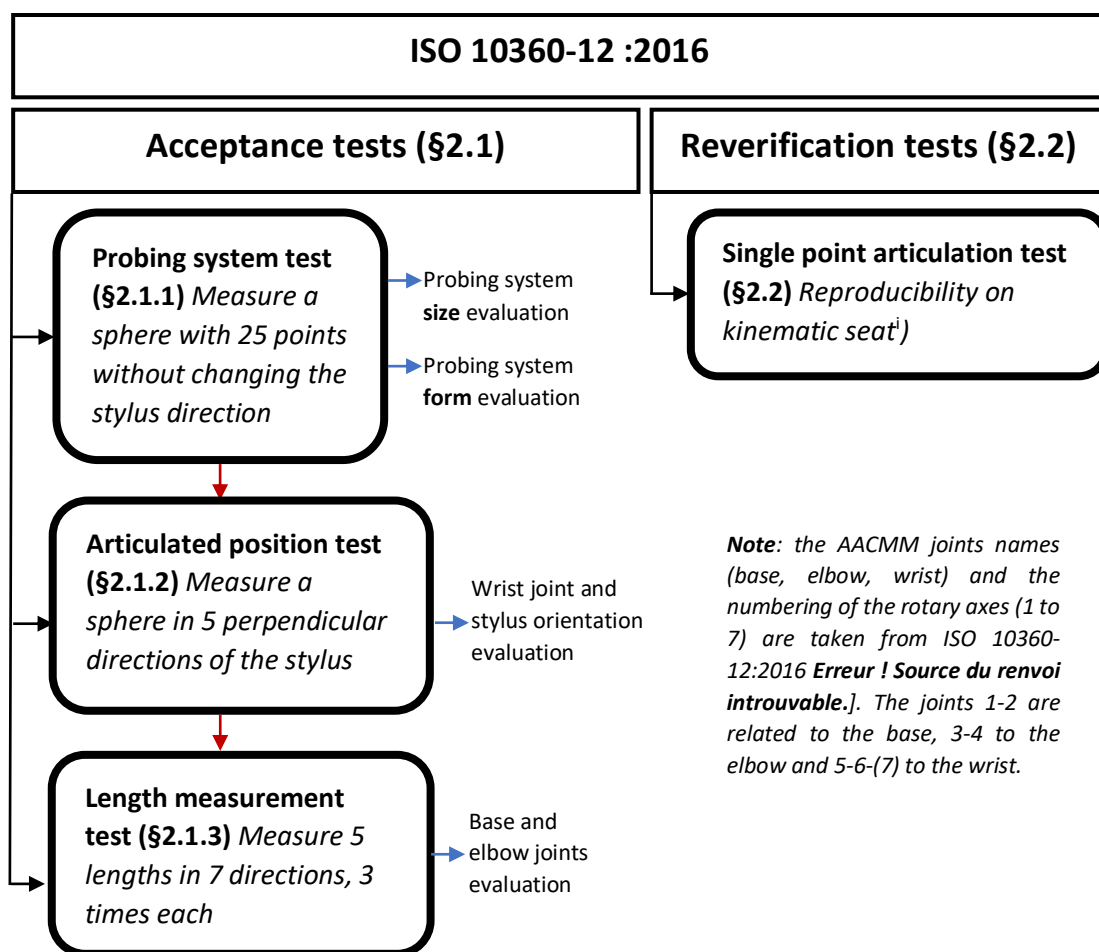

Figure 1 : Summary of the recommended tests in ISO 10360-12:2016

2.1 ACCEPTANCE TESTS

The acceptance tests are the tests that the user should perform after purchasing the AACMM or after a maintenance intervention, a renovation, etc. to make sure that the machine conforms to the manufacturer's specifications. In this section, we analyze the usefulness and the information extracted from each of the acceptance tests recommended by ISO 10360-12:2016.

2.1.1 Probing system test

The first test to perform is the probing system test. In this test, the user measures a sphere in two different positions in the working volume of the AACMM. The sphere is measured with 25 points uniformly distributed on at least one hemisphere. It is important that the user does not change the direction of the stylus while measuring, because the aim of the test is to characterize the probing system, independently of any other uncertainty source (joints, segments, mechanical deformation, etc.). It is also important to make sure that the AACMM elbow is properly balanced while measuring, to avoid any vibration or mechanical strain that may increase the uncertainty.

The test requires measuring 25 points on the sphere, because the probing system form error, that we want to identify by this test, is the maximal radial distance between the points of the probing system sphere. Therefore, the more points we probe on the sphere, the more likely it is to coincide with the extremal points. 25 points is then a compromise between the measurement time and the actual needed information.

2.1.2 Articulated positions test

The second test to perform, after passing the probing system test, is the articulated positions test. In this test, the user measures 5 times a sphere in two different positions in the working volume of the AACMM. In each time, the user measures five points on the sphere without changing the direction of the stylus. The aim of the test is to assess the uncertainty resulting from the movement of the wrist joint (axes 5, 6 and eventually 7). The importance of this test is to see how different are the measurements of the same point, with different positions of the AACMM wrist. In fact, the user measures the same point (sphere center) five times, with different positions of the wrist joint, and then calculates the diameter of the circumscribed sphere to the five centers. This test can be seen as a reproducibility of the wrist joint, which means, that it also can be performed with a kinematic seat¹.

It is worth noting that if there is any problem with the probing system calibration procedure of the AACMM, it will be identified with this test.

2.1.3 Length measurement test

The length measurement test is the last test to perform among the acceptance tests, after validating the previous two tests (probing system test and articulated positions test). In this test, the user measures 5 standards lengths in 7 directions (1 vertical, 3 horizontal and 3 at 45 degrees) and each measurement should be repeated 3 times. Altogether, the test includes 105 length measurements. The aim of the test is to assess the uncertainty resulting from the movement of the base and the elbow joints (axes 1 to 4), the segments orientation and the mechanical deformation of the structure in different measuring positions in the working volume. It is important to perform the test in the optimal environment conditions to limit the contribution of any other uncertainty sources in the results.

The difficulty of the test lies in finding the artifact with which the test can be performed. In fact, ISO 10360-12 requires that at least one of the lengths used in the test covers 66% of the AACMM working volume. For example, with a commonly used AACMM with a working volume of 3 meters, the user needs to have a length artifact of 2 meters, and find a way to orientate the 2 meters artifact in 7 different directions.

We propose for the purpose of this test, the tetronom ball bar artifact of the company Aimess Products, shown in Figure 2. It is a patented system based on joining several ball bars to build a longer ball bar. The ends of the bars are made of a magnet with a cavity, where the joining sphere is maintained. An extensible tripod help orientate the ball bar in different directions. The advantage of this artifact is its transportability, as it is easily removable and mountable. This is not the case for classical ball bars or step gauges which are heavy and bulky and require a swivel support to be directed in the different orientations required from ISO 10360-12:2016, plus the problems of rigidity for these artifacts are important.

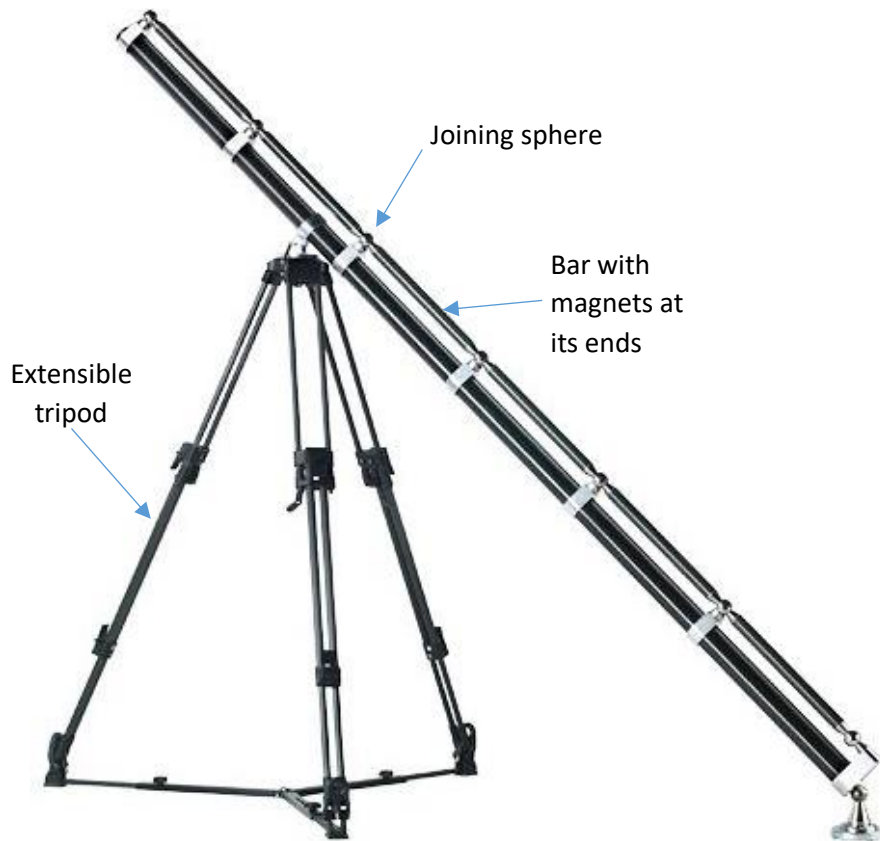

Figure 2: [1] Tetronom Ball Bar

The acceptance tests, as stated previously are performed after important events (purchase, maintenance, renovation, etc.) to check if the AACMM conforms to the manufacturer's specifications in the optimal environment and working conditions. However, the checking of the AACMM performance cannot be limited to these occasional tests; the AACMM should be periodically checked to make sure that nothing there have no evolution, problems or deterioration in the AACMM structure over time. The periodic reverification tests recommended by ISO 10360-12 are presented in the following section.

2.2 REVERIFICATION TESTS: SINGLE POINT ARTICULATION TEST

The reverification tests are the tests that the user should perform periodically to reverify the performance of the AACMM. Their aim is to make sure that there has been no deterioration in the AACMM structure or evolution in its parameters over time. ISO 10360-12:2016 proposes in Annex D (informative) the single point articulation and specifies that the user can perform as reverification test, and specifies that it is useful to carry out some additional length measurement tests. The usefulness of this test and its limits are presented in the following paragraph.

In this test, the user places the probe sphere in a kinematic seatⁱ and balances the AACMM elbow from side to side two times (for example from right to left and then from left to right) and measures 10 points. This test is fast and efficient to detect in fact problems resulting from the base or the wrist joint. It is important to mention though that the user can perform this test without moving much the elbow joint, which means that there might a problem with the elbow joint that the user will not be able detect based only on this test results. Therefore, we assume that the user will do better to perform

the single point articulation test balancing the AACMM from side to side (as described in ISO 10360-12:2016) in two directions, for example from left to right and from front to back and vice versa. In this case, the user will have moved the base, the elbow and the wrist joints.

The test presented in this section (cf. §2) aim to assess the AACMM inherent uncertainty – independently of any external factors such as environment – and to verify that it matches the manufacturer’s specifications. However, these tests are not sufficient to evaluate the uncertainty measurement on-site, as the on-site environmental conditions can be different from the manufacturer’s optimal specifications. In the following section, we discuss the importance of on-site verification and we propose some example of artifacts that help perform these test. We also propose a methodology of on-site measurement uncertainty assessment.

3 ON-SITE VERIFICATION

The tests recommended by ISO 10360-12:2016 are acceptance and periodic reverification tests. The acceptance tests are performed after the purchase of the AACMM, a maintenance intervention on the machine, a renovation, etc. On the other hand, the reverification tests aim to periodically check the performance of the AACMM and detect if any evolution or any problem has occurred in the meantime. Hence, the standard does not address the on-site verification topic, which we address in this section of the paper.

One of the main advantages of AACMMs is their portability. They are mainly meant to be used in different environments and to perform measurements in different conditions. Therefore, the reverification of their performance before any on-site measurement is highly recommended to detect if the conditions in the site are favorable to measure and to estimate the measurement uncertainty in the site. In the following paragraphs, we propose some on-site verification tests and we present the artifacts required to perform these tests.

The AACMMs uncertainty is divided into two types, namely the precision and the accuracy. The precision is the random error due mainly to vibration, to the operator and to the metrological traceability chain. The accuracy is the systematic error due to calibration residual errors, to temperature and other factors. The repeatability error [11] can be identified through tests with repeatable kinematic seats. The Figure 3 below summarizes the on-site verification possible tests.

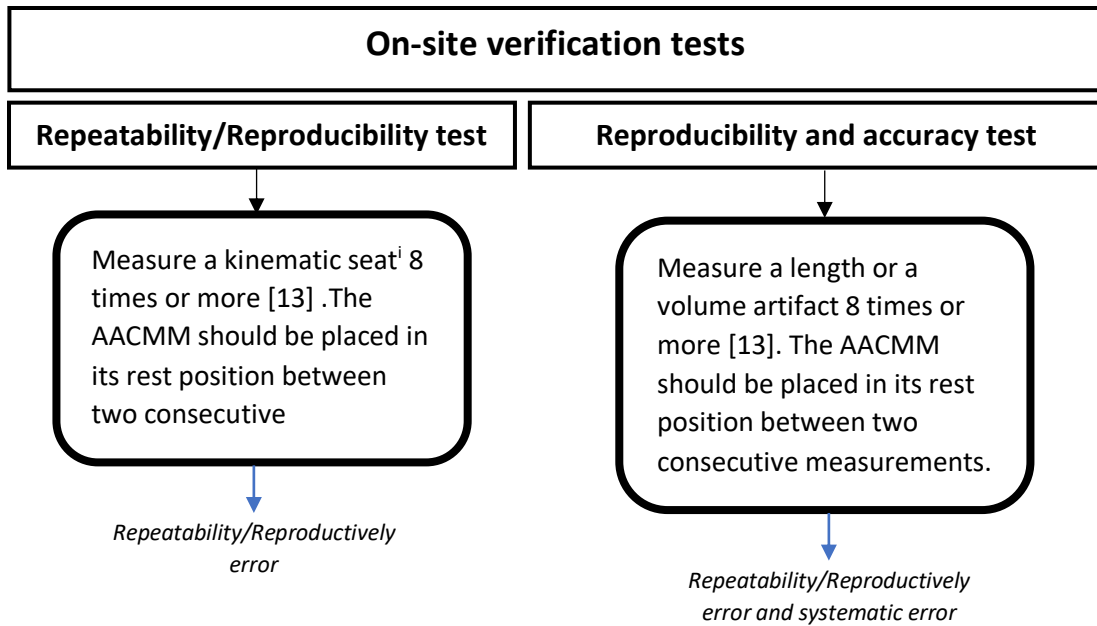

Figure 3 : Summary of the recommended on-site verification tests

The repeatability/reproducibility [11] test is a fast test that enables the user to quickly detect important problems in the measuring site due to vibration, to a bad fixation or any malfunction in the metrological traceability chain. On the other hand, the reproducibility and accuracy [11] test is highly recommended because it includes the reproducibility part, and in addition, enables the user to generally assess the AACMM systematic error [11] the in the site.

The on-site verification tests are different from the acceptance and the periodic reverification tests, regarding that the on-site verification's aim is characterizing the measurement conditions when we know that the AACMM conforms to the specifications, whereas the acceptance and periodic reverification tests are performed in the optimal conditions specified by the manufacturer, to characterize exclusively the AACMM.

The Table 1 below presents the main uncertainty sources in acceptance/periodic reverification tests and in on-site verification tests.

Table 1: main uncertainty sources

Errors	Acceptance and periodic reverification tests	On-site verification tests
Precision (Random error) [11]	<ul style="list-style-type: none"> - Limited vibrations and environmental fluctuations - Structure repeatability 	<ul style="list-style-type: none"> - Variable vibrations and environmental fluctuations - Non-optimal metrological traceability chain
Accuracy (systematic error) [11]	<ul style="list-style-type: none"> - Calibration - Mechanical deformation due to the operator 	<ul style="list-style-type: none"> - Temperature - User's dexterity

In the following paragraphs, we present an illustration of on-site verification test. In fact, we have realized the on-site verification tests proposed in Figure 3 with different artifacts. We have actually performed the repeatability test with a kinematic seat and the reproducibility and accuracy test with a step gauge, a ball bar and a patented innovative volume artifact called tetronom that is fully presented later.

3.1 ON-SITE REPEATABILITY/REPRODUCIBILITY VERIFICATION TESTⁱⁱ

A repeatability/reproducibility test consists of measuring a kinematic seatⁱ several times. For a repeatability test, the kinematic seat is always measured in the same configuration whereas for a reproducibility test, the kinematic seat is measured in different configurations. For example, the ISO 10360-12:2016 reverification test, presented in the paragraph §2.2 is a reproducibility test.

As stated previously, the repeatability/reproducibility enables the user to detect if there are any important vibrations in the site or an eventual malfunction in the metrological traceability chain, such as a bad fixation of one component of the chain.

A recommended test would be to measure the kinematic seat 20 times, trying in each time to measure the seat in a different position (balancing the AACMM from side to side and back and forth). It is highly recommended to replace the AACMM in its rest position after each measurement. Comparing the standard deviation of the 20 measurements to the AACMM SPAT¹ error given by the manufacturer, or to the tolerance required for the measurements, the user can identify whether the site conditions may be favorable to measure or for sure are not.

To illustrate the importance of on-site repeatability tests, we have performed two repeatability tests in the same conditions. The tests, as said above, consist of measuring a kinematic seat 20 times. The only one difference is that in the first test, the AACMM was not placed in its rest position at all during the test, whilst in the second test, the AACMM was placed in its rest position after each measurement. After analyzing the tests results presented below, we found that the metrological traceability chain was not optimal (unstable fixation of the AACMM). The detection of this problem would not have been possible if the on-site repeatability tests were not performed.

The retrieved data at the end of each of the tests are the coordinates (X,Y,Z) of the 20 points. The standard deviation of these coordinates is calculated in Table 2 and the graphic representation of the coordinate X of the 20 points is presented in Figure 4.

Table 2 : Repeatability tests numerical results

test	Standard deviation the direction X	Standard deviation the direction Y	Standard deviation the direction Z
Test 1 (Repeatability without placing the AACMM in its rest position between the measurements)	7	4	5
Test 2 (Repeatability with placing the AACMM in its rest position between the measurements)	80	47	4

As shown in Table 2, the difference between the results of the two tests is huge, especially for the direction X. The Figure 4 shows the evolution of the x-coordinate during the tests (for the 20 measurements).

ⁱ Kinematic seat: a seat that can move in a controlled way.

ⁱⁱ Repeatability/reproducibility verification test: a test that allows to verify the repeatability/reproducibility of the measurements.

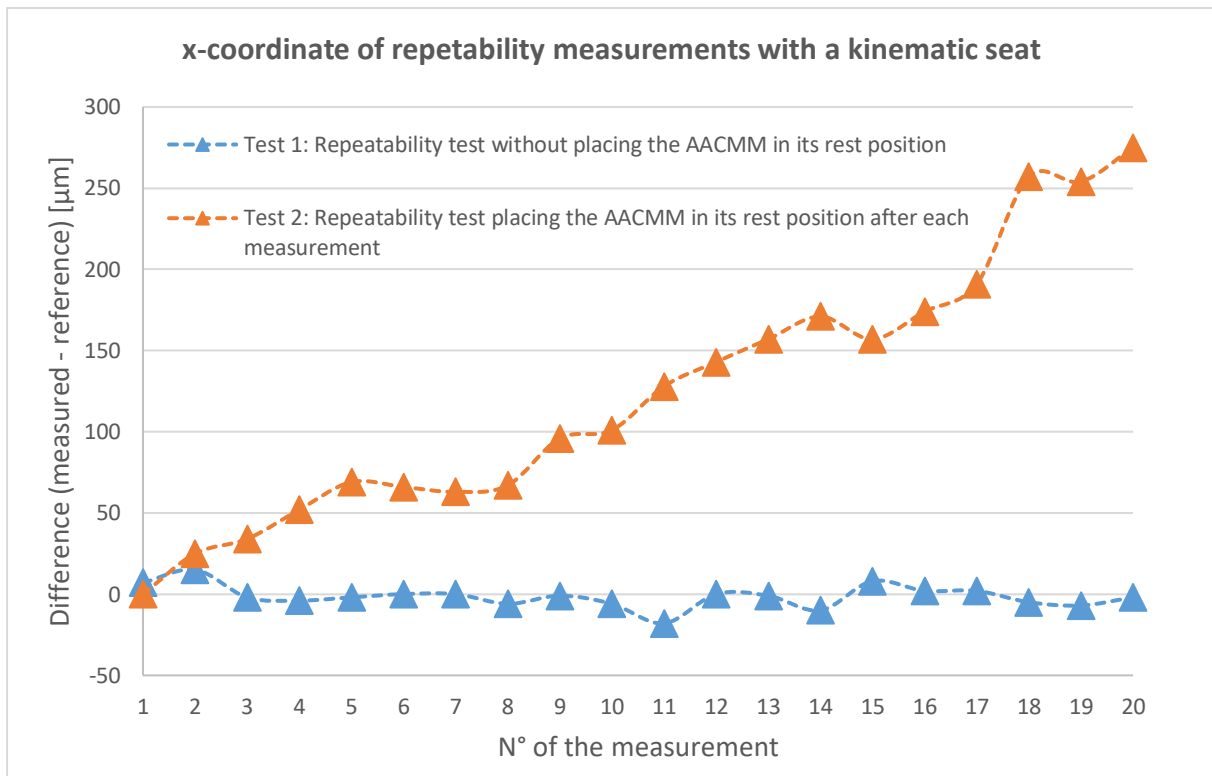

Figure 4 : Repeatability test graphic results

Note: The reference value for plotting the measurements results in Figure 4 is the average value of the test 1.

Let us stress one more time that both of the tests were carried out in the same conditions. The important deviation of the measurements in the second test is actually due to an unstable fixation of the AACMM, that we could not identify visually. As the AACMM was not placed in its rest position during the first test, this problem has not been detected with this test. **If the second verification test was not done, the user could have started his measurements in these unfavorable conditions.**

To summarize, On-site repeatability tests are important and should include different positions of the AACMM (including the return to the rest position). However, they allow the user to detect only important problems in the measurement site due to random sources. They do not allow any estimation of the uncertainty in the site.

For assessing the measurement site uncertainty, the verification tests presented in the following paragraphs (using length or volume artifacts) are recommended.

3.2 ON-SITE VERIFICATION TEST USING STANDARD LENGTH ARTIFACTS

The length artifacts that can be used for on-site verification using a tactile probe are gauges, ball bars and bars with kinematic seats. Annex B of ISO 10360-12:2016 presents the methodology of measuring these artifacts. An on-site verification test with any of these artifacts, consists of measuring the artifact with different positions of the AACMM (Elbow balanced on the right side then on the left side) and with different orientations of the probing system stylus (perpendicular to the surface, tangent, inclined, etc.). It is important to mention that, to be able to estimate the on-site measurement uncertainty, each measurement should be repeated 8 times or more [13].

To illustrate on-site verification test method using length artifacts, we have performed the test with a step gauge and a ball bar. The tests are presented in the next paragraphs.

3.2.1 On-site test with a gauge and resultsⁱⁱ Erreur ! Signet non défini.

As an illustration of on-site verification tests, we have carried out ten measurements of a Mitutoyo step gauge, in each of the following positions:

- **Position 1:** Bidirectionalⁱⁱⁱ test. The AACMM is balanced to the right to measure one side of the gauge and is balanced to left to measure the other side of the gauge. The stylus is perpendicular to the measured gauge plan. This position is noted **LN/RN** according to the notations of Figure 5.
- **Position 2:** The AACMM is balanced to the right to measure one side of the gauge and is balanced to left to measure the other side of the gauge. The stylus forming a 45 degrees angle with the measured gauge plane. This position is noted **LI/RI** according to the notations of Figure 5.
- **Position 3:** The AACMM elbow balanced to the left side. The stylus is vertical and tangent to the measured gauge plan. This position is noted **LV/LV** according to the notations of Figure 5.
- **Position 4:** The AACMM elbow balanced to the right side. The stylus is vertical and tangent to the measured gauge plan. This position is noted **RV/RV** according to the notations of Figure 5.

The Figure 5 below shows the test conditions and the measurement positions. The nominal value of the measured length is 610 mm.

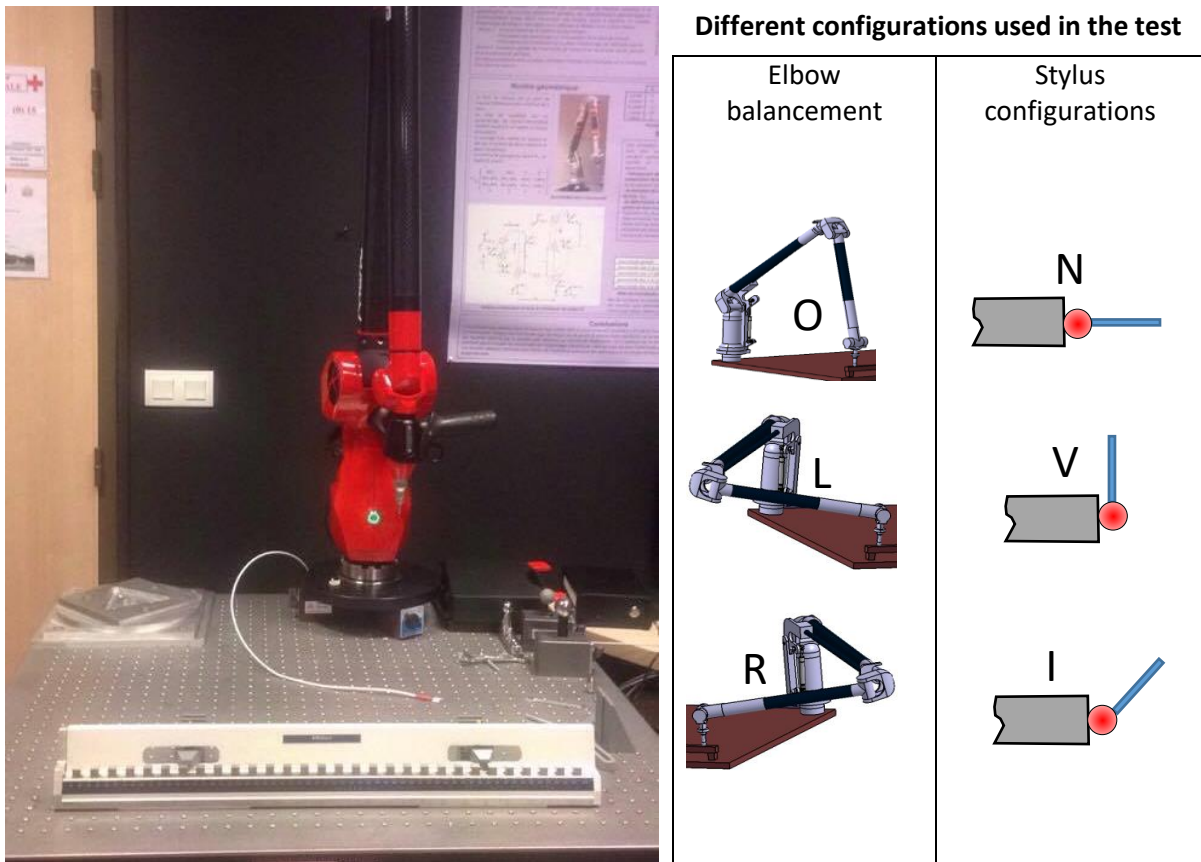

Figure 5 : On-site verification test with a step gauge

Note: The AACMM has an internal balancing system that balances the elbow in the horizontal bend position, either to the left or to the right. This is the most stable position to measure. Therefore, the user should not measure in a vertical position (position "O" in Figure 5), unless the measured item is

large and is not possible to measure with the AACMM balanced horizontally. That is why, in the test with the gauge presented in this paragraph and in the test with the ball bar presented in the next paragraph (cf. §3.2.2), we have not tested the vertical position. In fact, these artifacts can be used for on-site verifications tests only when measuring small items, which do not require the use of the AACMM in the vertical position.

Figure 6 shows a graphic representation of the test results.

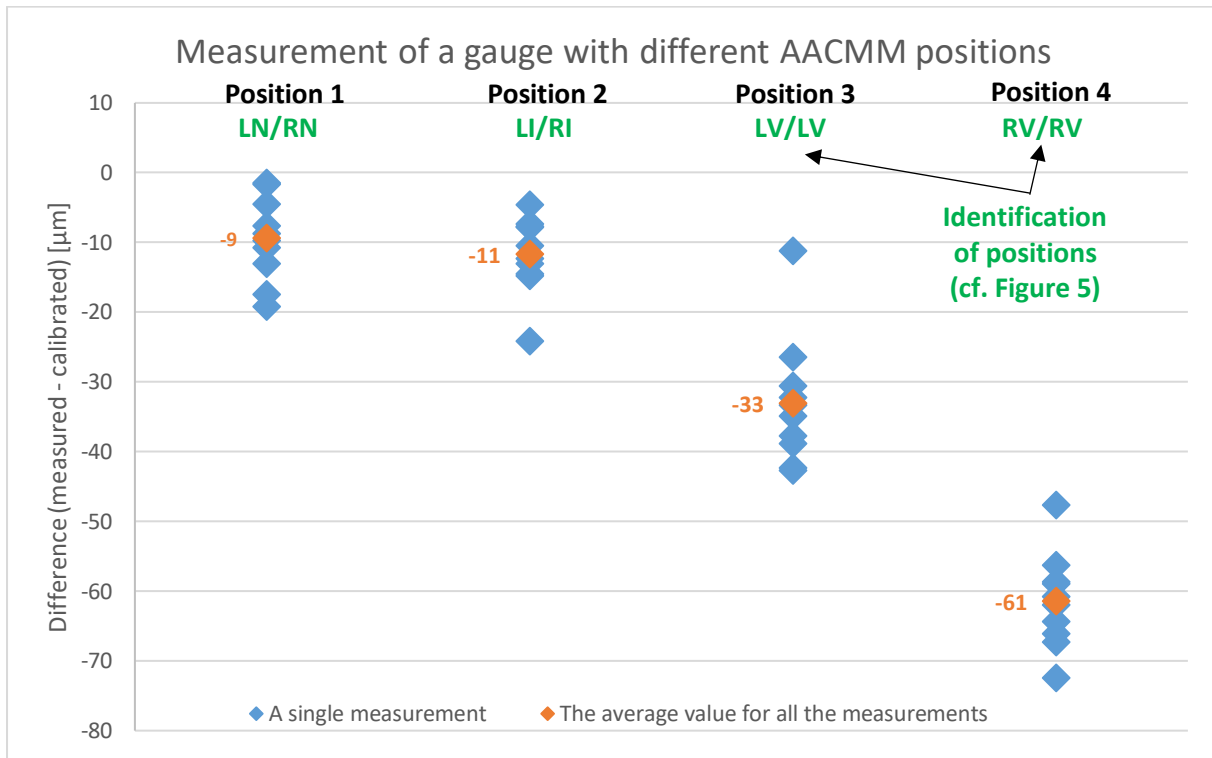

Figure 6: Graphic results of the on-site verification test with a gauge

The Figure 6 above shows that the measurement AACMM position has a significant impact on the results. The distribution of the values around the average value is almost the same for all the positions, but the average value differs from a position to another.

The Table 3 below contains the numerical results of the test, and the calculations of the last line are explained right after.

Table 3: Results of the on-site verification using a step gauge

Positions (cf. Figure 5)	Average error of the measured lengths ^{iv} [μm]	Standard deviation of the measured lengths [μm]	Range of error ^v [μm]
Position 1 (LN/RN)	-9	6	18
Position 2 (LI/RI)	-12	6	20
Position 3 (LT/LT)	-33	9	31
Position 4 (RT/RT)	-61	7	25
All 4 Positions together	-29	22	71

The last line of Table 3 correspond to all the positions together (40 measurements: 4 positions with 10 repetition each). The average error, the standard deviation and the range of error in the last line were calculated directly from the 40 measurements.

Assuming that the distribution of the measured values is Gaussian normal, the AACMM random error (or precision) in the site is characterized by the standard deviation of the 40 measurements (last line of Table 3), and the systematic error (or accuracy) is the average value of the differences between the measured lengths and the calibrated value (measured – calibrated).

The on-site verification results are then:

- **Precision** (*Random error*) = $22 \times \frac{L}{610}$ [μm], where L is the measured length in mm. (The error is in μm though)
- **Accuracy** (*systematic error*) = $-29 \mu\text{m}$

It is worth noting that for a Gaussian normal distribution $\mathcal{N}(\mu, \sigma^2)$, whose mean value is μ and standard deviation is σ , 99,73% of the population is contained in the range $[\mu - 3 \times \sigma, \mu + 3 \times \sigma]$. This means that the maximal deviation between two values does not exceed $6 \times \sigma$, with a probability of 99,73%. In our case, we verify that in fact: $6 \times \underset{\text{Standard deviation}}{22} = 132 > \underset{\text{Maximal deviation}}{71}$, which does not contradict the

Gaussian normal distribution assumption.

3.2.2 On-site test with a ball barⁱⁱ

We have presented an on-site test with a gauge in the previous paragraph. In this paragraph, we perform the same test, with the same positions, using a ball bar. The results of both on-site tests (with a gauge and with a ball bar) will be compared, and the advantages and disadvantages of these different length artifacts will be discussed in the next paragraph.

The Figure 7 below shows the test conditions and the measurement positions. The nominal value of the measured length is 400 mm. Each sphere of the ball bar was measured with 4 points.

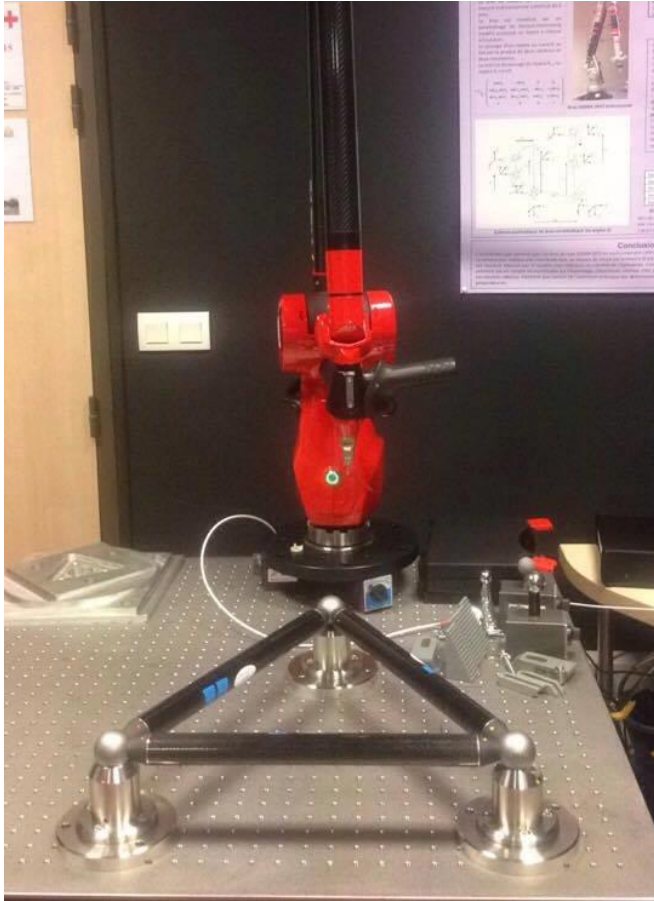

Different configurations used in the test

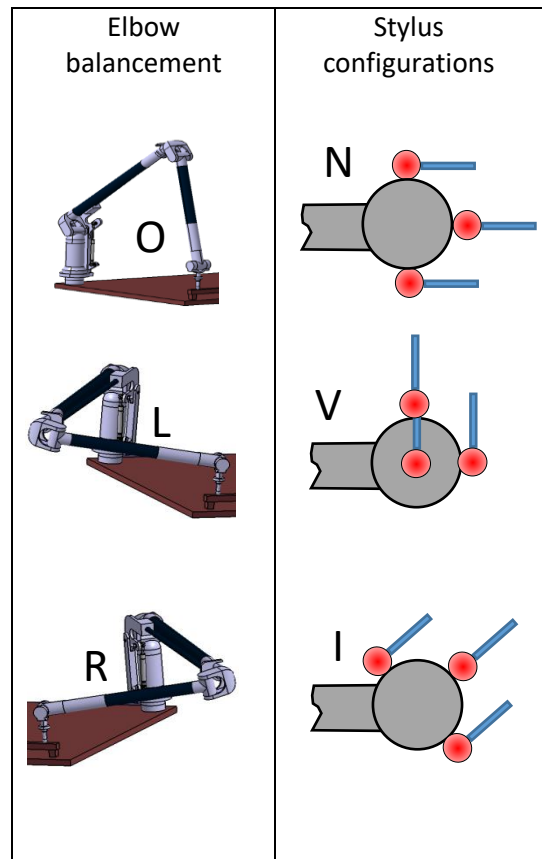

Figure 7 : On-site verification test with a ball bar

A graphic representation of the test results is shown in Figure 8.

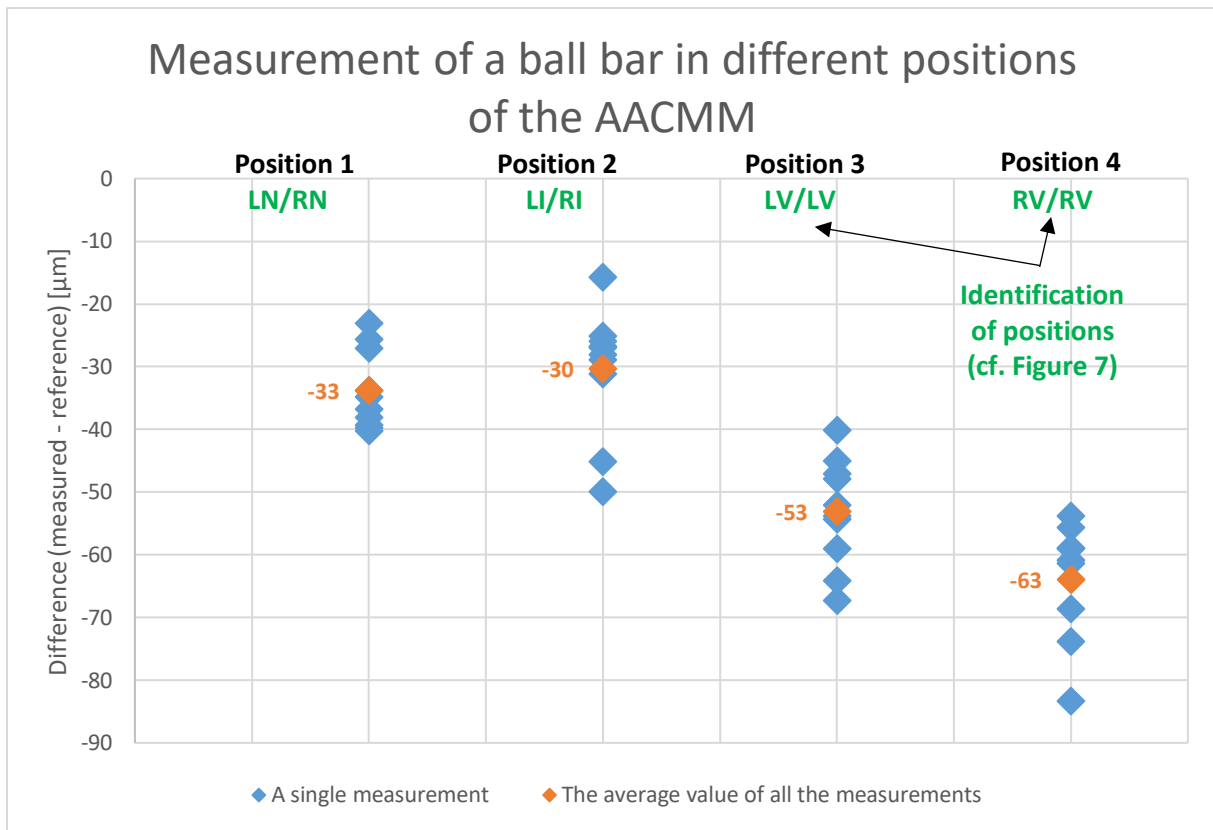

Figure 8 : Graphic results of the on-site verification test with a ball bar

The Figure 8 above shows that the measurement AACMM position has an effect on the results when using a ball bar (as when using a step gauge, cf. Figure 6). As for the step gauge, the distribution of the values around the average value is almost the same for all the positions but the average value differs from a position to another.

The Table 4 below contains the numerical results of the test.

Table 4 : Results of the on-site verification using a ball bar

Positions (cf. Figure 7)	Average error of the measured lengths ^{iv} [μm]	Standard deviation of the measured lengths [μm]	Range of error ^v [μm]
Position 1 (LN/RN)	-34	6	18
Position 2 (LI/RI)	-30	10	20
Position 3 (LT/LT)	-53	9	31
Position 4 (RT/RT)	-64	10	25
All 4 Positions together	-45	16	71

Following the uncertainty methodology presented in the paragraph §3.2.1, we obtain the following results:

- **Precision (Random error) = $16 \times \frac{L}{400}$ [μm]**, where L is the measured length in mm. (The error is in μm though)
- **Accuracy (systematic error) = -45 μm**

We verify again that: $6 \times \underbrace{16}_{\text{Standard deviation}} = 72 > \underbrace{68}_{\text{Maximal deviation}}$, which does not contradict the Gaussian normal distribution assumption. (cf. §3.2.1 for details).

The results of the on-site verification tests with a gauge and with a ball bar are discussed in the next paragraph.

3.2.3 Results discussion and Advantages and disadvantages of length artifacts

The two on-site tests with a gauge and with a ball bar presented in the previous paragraphs §3.2.1 and §3.2.2 were performed in order to identify the advantages and limits of each one. The Table 5 below summarizes the results.

Table 5 : Summary of on-site verification tests using length artifacts

Positions (cf. Figure 5 et Figure 7)	Accuracy [μm]		Precision (Relative standard deviation [$\times \frac{L}{400}$] μm) ^{vi}		Range of error [μm]	
	gauge	Ball bar	gauge	Ball bar	gauge	Ball bar
Position 1 (LN/RN)	-9	-34	6	6	18	17
Position 2 (LI/RI)	-12	-30	6	10	20	34
Position 3 (LT/LT)	-33	-53	9	9	31	27
Position 4 (RT/RT)	-61	-64	7	10	25	29
all 4 Positions together	-29	-45	14	16	71	68



It seems that the ball bar and the gauge provide the same precision, as the standard deviation as well as the maximal deviation are approximatively the same for both of the gauge and the ball bar. However, the systematic error is lesser using a ball bar than using a gauge.

On-site verification tests, as mentioned previously, can be performed with a bar with kinematic seats as well. The bar with kinematic seats is certainly easier and faster to measure. However, it does not allow the user to perform the test in all the possible positions of measurement in a real application. In fact, a kinematic seat can only be measured with the probing system stylus normal or inclined. It cannot be measured with the stylus tangent. Hence, a limit of this artifact is that it does not allow the user to test all the possible AACMM measurement positions.

To sum up, we have discussed the advantages and disadvantages of the common length artifacts in Table 6.

Table 6 : Advantages and disadvantages of length artifacts

Artifact	Step gauge	Ball Bar	Bar with kinematic seats ⁱ
----------	------------	----------	---------------------------------------

illustration			
Advantages	-Very common artifact	-Possible optical measurements -Common artifact	-High repeatability and reproducibility -Easy and direct measurement of the point
Disadvantages	-Only tactile measurements -Creation of a frame of reference before measuring - less reproducibility	-Time of measurement (4 points at least)	-Only tactile measurements -Not common - Less representative of real applications

On-site verification with length artifacts is efficient when measuring small items. However, the measured items can be larger than a gauge or ball bar. In this case, a verification in the volume is required. The user should measure the length artifact in different directions in the volume. For this purpose, the tetronom, a patented artifact adapted to on-site verifications is presented in the following paragraph.

3.3 ON-SITE VERIFICATION TEST USING A TETRAHEDRAL ARTIFACT

3.3.1 Presentation of the Tetronom artifact

The tetronom (cf. Figure 9) is a removable and traceable tetrahedral artifact. It consists of six single bars and four spheres. Each sphere is in contact with three bars. The ends of the bars are made of a magnet with a cavity, where the joining sphere is maintained. The advantages of this system is the easy mounting (in an isostatic way) and its very low thermal expansion.

The mounting of the tetronom is adapted to on-site verification tests because it is fast and easy. In fact, each bar has two colored marks at its ends and each support is marked with colored dots as well (cf. Figure 10). The user simply joins the bars that have the same color with the matching support. For example; the three bars that have a red dot at one of their ends are mounted on the same sphere, which is mounted on the support with red marks, and so on (cf. Figure 10).

The bars are made of carbon fiber reinforced plastic (CFRP) to keep it light and easily portable, and the spheres are preferably in matte stainless steel balls, so that the artifact can be used with tactile probing systems but also with laser scanning devices.

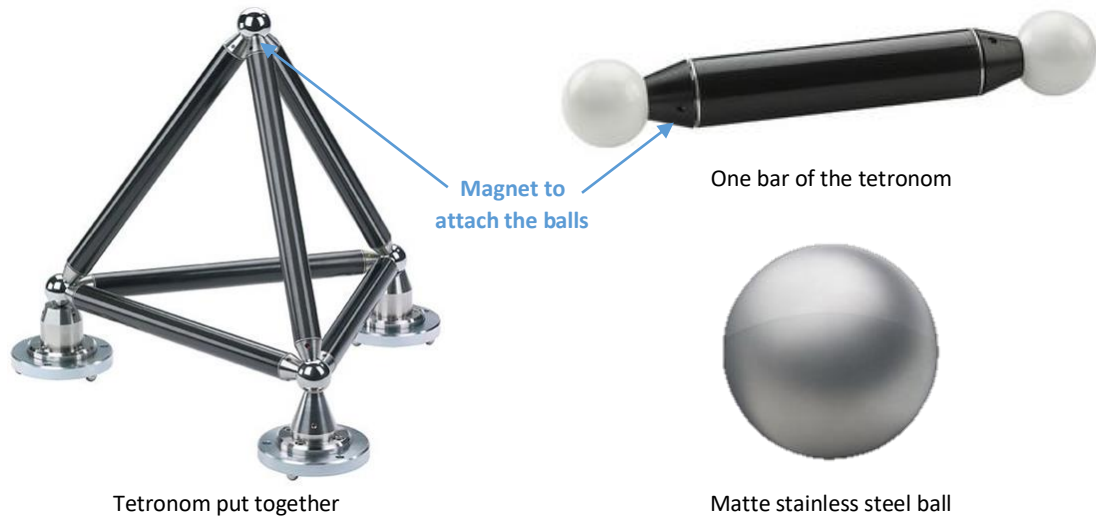

Figure 9 : [1]Artifact Tetronom for on-site verification

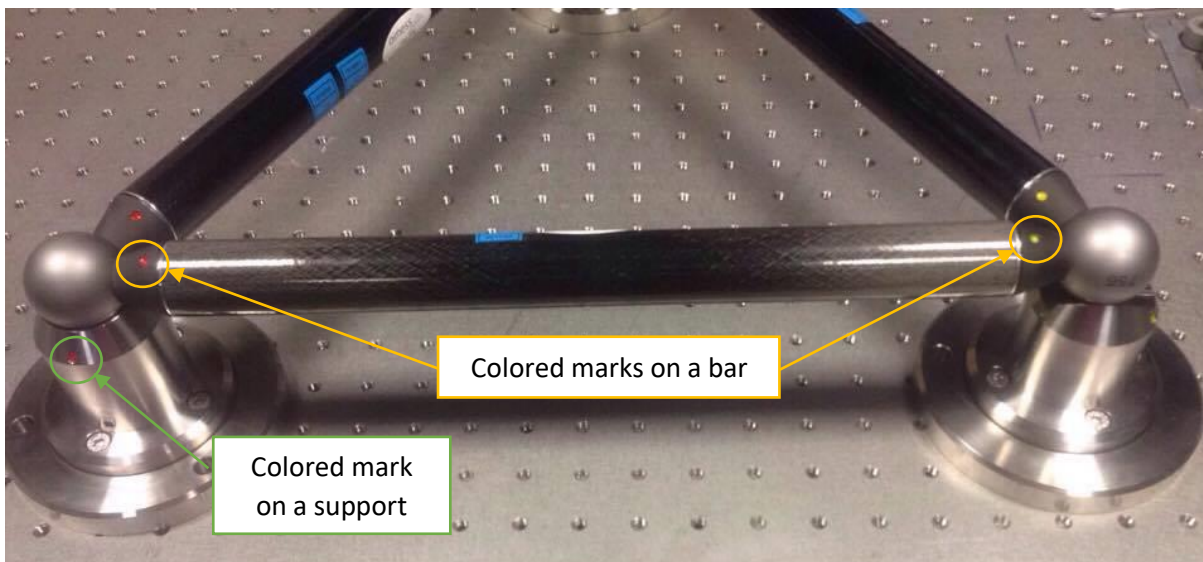

Figure 10 : Mounting the tetronom based on the matching colored marks on the supports and the bars

3.3.2 Tetronom patented 3-2-1 assembly principle

The tetronom is fixed on the three supports with a 3-2-1 fixation principle. One of the three spheres of the base is in contact with three concave surfaces in its support (cf. support 1 in Figure 11), which eliminates the three translations in space. Another sphere is in contact with two plan surfaces in its support (cf. support 2 in Figure 11), which eliminates two rotations. Finally, the last sphere of the base is in contact with the only one surface of its support (cf. support 3 in Figure 11), which eliminates the remaining rotation. Thanks to this isostatic fixation, the tetronom presents two important advantages: very high mounting repeatability and stress-free structure.

It is also possible to measure the tetronom at a different height by adding extensions to the base spheres supports (cf. Figure 12).

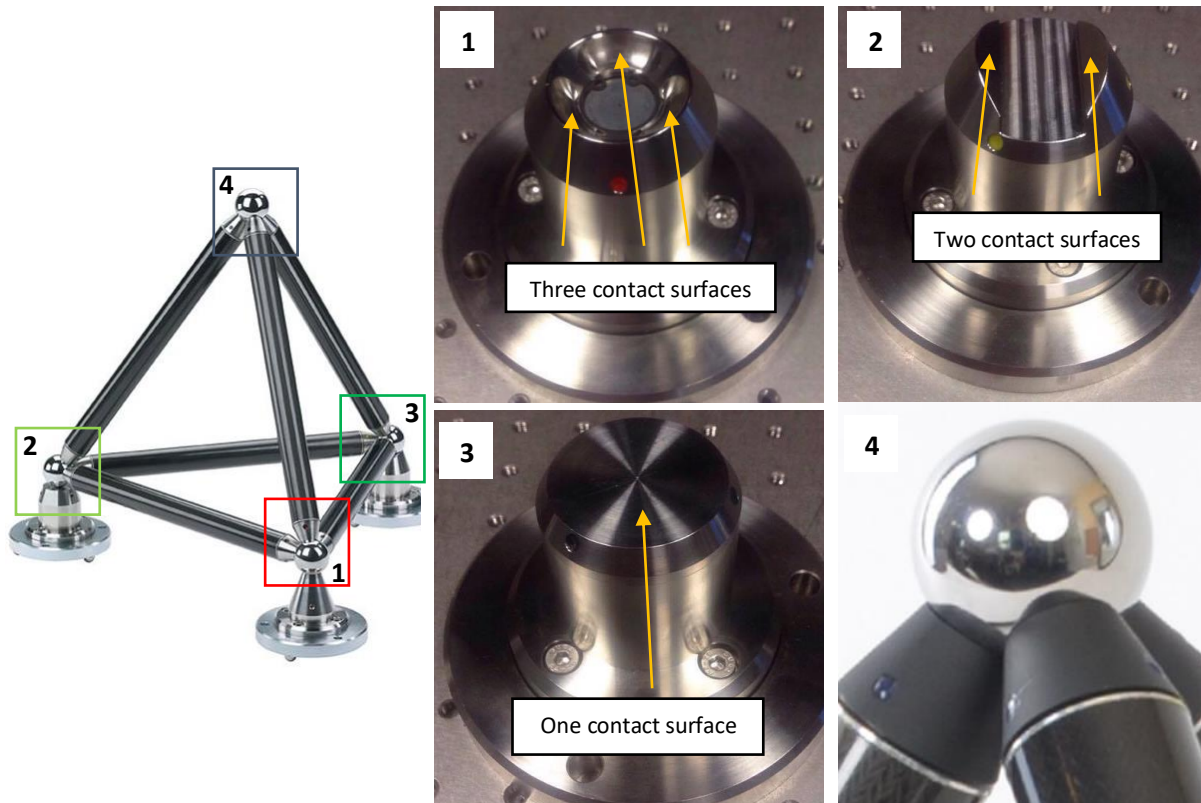

Figure 11 : isostatic 3-2-1 alignment of the tetronom

3.3.3 Illustration of the tetronom and resultsⁱⁱ

To illustrate the use of the tetronom for on-site verification, a tetronom of 400 mm (length of the bars) was used. The on-site test consists of measuring the six lengths of the tetronom 10 times. The test was performed with the support extensions (cf. Figure 12). Each sphere is measured with 5 points.

An illustration of the conditions of the test is presented in Figure 12.

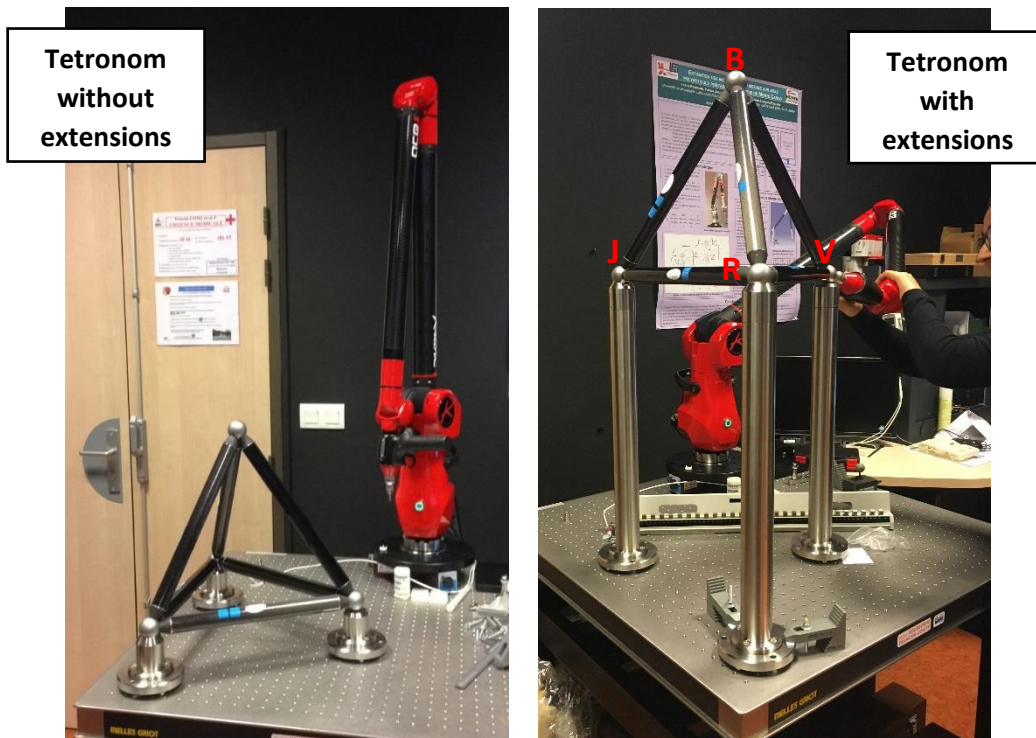

Figure 12 : On-site verification using a tetronom artifact

The results of the test are presented in Table 7 and the calculation details are explained right after.

Table 7 : Results of the on-site verification using a tetronom artifact with support extensions

Lengths (cf. Figure 12)	Average measured error ^{vii} [μm]	Standard deviation of the measured errors ^{viii} [μm]	Range of error on the length measured ^{ix} [μm]
Length 1 (RJ)	-35	25	84
Length 2 (RV)	70	12	40
Length 3 (JV)	-4	32	125
Length 4 (RB)	-2	11	42
Length 5 (JB)	48	51	147
Length 6 (VB)	31	10	32
All 6 lengths together	18	44	209

Each length (L_i ; $1 \leq i \leq 6$) was measured 10 times. For each measurement, the difference between the measured value and the calibrated length was calculated, let us note it d_{ij} ; $1 \leq i \leq 6$; $1 \leq j \leq 10$. The average value and the standard deviation displayed in each line of Table 7 correspond to the values d_{ij} ; $1 \leq j \leq 10$, for a given i (which means a given length of the tetronom). The last line considers all 6 lengths together, which means that the average value and the standard value of the last line correspond to all the d_{ij} ; $1 \leq i \leq 6$; $1 \leq j \leq 10$ values. The same goes for the maximal deviation.

Following the uncertainty methodology presented in the paragraph §Erreur ! Source du renvoi introuvable.3.2.1, we obtain the following results:

- **Precision (Random error) = $44 \times \frac{L}{400}$ [μm]**, where L is the measured length in mm. (The error is in μm though)
- **Accuracy (systematic error) = 18 μm**

We verify that: $6 \times \frac{44}{\text{Standard deviation}} = 264 > \frac{209}{\text{Maximal deviation}}$, which does not contradict the Gaussian normal distribution assumption. (cf. §3.2.1 for details).

The comparison of on-site verification tests results using length artifact or the tetronom is presented in the next paragraph.

3.3.4 On-site verification tests comparison and analysis

In the previous paragraphs, on-site verification tests performed with a step gauge, a ball bar and a tetronom (cf. §3.3.1) were presented. The Table 8 summarizes the test's results.

Table 8 : On-site verification tests with different artifacts

Artifact	Accuracy [11] (systematic error)	Precision [11] (Random error) $[\times \frac{L}{400} \mu\text{m}]^{\text{vi}}$
Gauge	-29	14
Ball bar	-45	16
Tetronom	18	44

Before discussing the results, let us mention that the AACMM calibration is realized on average in the whole working volume. This means that the systematic error in the whole working volume, on average, is zero. Therefore, the systematic error in a specific area in the working volume might be negative or positive, but is zero on average in the working volume. However, the random error is expected to be lesser in a smaller area than a larger area, because moving the AACMM in a smaller area induces less difficulty of measuring for the user, which is one of the main sources of random uncertainty. To sum up, it is expected that the larger the measurement area, the greater the random error and the less the systematic error.

As expected, the results show that the gauge and the ball bar placed approximately during the tests in the same position, give both a negative systematic error and the tetronom presents a systematic error lesser than the ball bar and the gauge (in absolute value) as it covers a larger area of the AACMM working volume. On the other hand, the random error is more important when using a tetronom than when using the ball bar and the gauge.

The user needs to be able to identify which artifact to use for his on-site verification test, regarding the application he has to perform after. The test artifact should be placed in the same area where the items are going to be placed for the measurements. The user should also take into consideration the shape of the items he is going to measure. Moreover, it is the responsibility of the user to identify which of the positions of measurement shown in the Figure 5 need to be tested. For example, in the on-site verification test illustration presented in the paragraph §3.2.1, we have tested the position 3 and 4 where the stylus is vertical and tangent to the measured gauge plane (cf. position "V" in Figure 5) This position may be used in a real situation, if for example the item contains two planes very close to one another, so that the user can not measure them with the stylus being normal to the measured plan. If the user knows that the item that he is going to measure does not present this type of geometry, then it is not worth testing these configurations.

Finally, it is obvious that these artifacts are still going to be different from the measured item. Let us stress another time that the aim of the on-site verification tests is not providing an exact estimation of the uncertainty of measurement; it is rather giving an order of magnitude of the uncertainty in the site. The overall aim of these tests is to be able to detect if there are any important issues in the site and to evaluate if we are far from the required tolerance.

4 SCANNING MODE

The tests presented previously, either those recommended by ISO 10360-12:2016 or those proposed for on-site verification, allow the user to evaluate the uncertainty of the AACMM structure and the tactile probing system. However, as AACMMs are often used with scanners instead of probing systems, it is important to set up a methodology to assess AACMMs uncertainty while used with scanners. The standard ISO 10360-9 addresses [Erreur ! Source du renvoi introuvable.] partially this topic by specifying the tests for evaluating the performance of Coordinate Measuring Machines (CMMs) with optical sensors. We are working on the adaptation of the tests recommended by the standard to AACMMs and on the interference between the structure uncertainty and scanner uncertainty. All the tests presented in the paper are still interesting for scanner applications, as the scanner is attached to the AACMM structure and the uncertainties resulting from the structure are part of the uncertainties of the system {AACMM + Scanner}, but the probing system test (cf. §2.1.1) should be replaced by a proper test related to the scanner.

5 CONCLUSION

The use of Articulated armed measuring Machine (AACMM) is not yet fully understood. In the first part of this paper, we presented the tests recommended by the standard ISO 10360-12:2016, including acceptance tests and periodic verification tests. We discussed the utility of these tests and the information that can be extracted from them. In the second part of the paper, we addressed the on-site uncertainty assessment by proposing some on-site verification tests and illustrating their practical interest with tangible examples.

AACMMs are stagnant in terms of design but are expanding in terms of improving their performance through modifying the procedures of measurement and evaluation, which make it possible to take maximum account of external factors such as the effects of the user. Moreover, the accelerated software development in the recent years made the use of AACMMs much easier and more ergonomic than before. It is worth mentioning that there are software nowadays, such as Polyworks, which make it possible for the user to create an entire inspection plan. This procedure, in addition to its interest in facilitating and speeding up the process of inspection, has the advantage of defining previously the measurement points, so that the operator cannot intentionally avoid manufacturing defects while measuring.

6 ACKNOWLEDGMENTS

The work presented in this paper is carried out in collaboration with Kreon Technologies (manufacturer of AACMMs), CETIM (Technical Center for Mechanical Industries) and Abaqsys Ingénierie (measurement and finite element simulation expert). The project is subsidized by the region Bourgogne Franche Comté and the Feder.

REFERENCES

- [1] Aimes Products, 21 July 2017. [Online]. Available: <http://www.aimess-products.de/en/company/>.
- [2] ASME B89.4.22-2004, *Methods for performance evaluation of articulated arm coordinate measuring machines*, 2004.
- [3] PR NF EN ISO 10360-12:2016, *Geometrical product specifications (GPS) -- Acceptance and reverification tests for coordinate measuring systems (CMS) -- Part 12: Articulated arm coordinate measurement machines (CMM)*., 2016.
- [4] D. González-Madruga, E. Cuesta, H. Patiño, J. Barreiro et Martinez-Pellitero.S, «Evaluation of AACMM using the virtual circles method,» *Procedia Engineering*, vol. 63, pp. 243-251, 2013.
- [5] A. Piratelli-Filho et L.-G. Lesnau, «Virtual spheres gauge for coordinate measuring arms performance test,» *Measurement*, vol. 43, pp. 236-244, 2010.
- [6] R. Acero, J. Santolaria, A. Brau et M. Pueo, «Virtual Distances Methodology as Verification Technique for AACMMs with a Capacitive Sensor Based Indexed Metrology Platform.,» *Sensors*, 2016.
- [7] E. Cuesta, D. González-Madruga, B.-J. Alvarez et J. Barreiro, «A new concept of feature-based for coordinate measuring arm evaluation,» *Measurement science and technology*, vol. 25, n° 16, 2014.
- [8] J. Santolaria, J.-J. Aguilar, J. Yagüe et J. Pastor, «Kinematic parameter estimation technique for calibration and repeatability improvement of articulated arm coordinate measuring machines,» *Precision Engineering*, vol. 32, pp. 251-268, 2008.
- [9] G. Gao, H. Zhang, X. Wu et Y. Guo, «Structural Parameter Identification of Articulated Arm Coordinate Measuring Machines,» *Mathematical Problems in Engineering*, 2016.
- [10] J. Santolaria, A. C.-Majarena, D. Samper, A. Brau et J. Velázquez, «Articulated Arm Coordinate Measuring Machine Calibration by Laser Tracker Multilateration,» *The Scientific World Journal*, 2014.
- [11] JCGM 200:2012, *International vocabulary of metrology – Basic and general concepts and associated terms (VIM)*, BIPM, 2008.
- [12] F. Romdhani, G. M. Hennebelle, F., P. Juillion, R. Coquet et J.-F. Fontaine, «Methodology of the assessment of measuring uncertainties of articulated arm coordinate measuring machines.,» *Measurement Science and Technology*, vol. 25, n° 12, 2014.
- [13] S. Bell, *A Beginner's Guide to Uncertainty Measurement*, Teddington, Middlesex, United Kingdom.: National physical laboratory, 2001.

Notes

ⁱ Kinematic seats are presented in annex Appendix G of ASME B89.4.22.2004. It consists of an isostatic location of a sphere.

ⁱⁱ All the tests included in this paper and presented in the table below were realized in the conditions below.

- AACMM: ACE II of Kreon Technologies
- Temperature: $T = 17 \text{ to } 21 \text{ } ^\circ\text{C}$
- Software : Polyworks
- Fixation of the AACMM and the measured artifact on the same support table. The AACMM is fixed with magnets.

Test	paragraph	equipment	Approximate time
Repeatability with a kinematic seat without rest position	§3.1	-15 mm diameter probing system -kinematic seat with a magnet at the bottom	5 minutes
Repeatability with a kinematic seat with rest position	§3.1	-15 mm diameter probing system -kinematic seat with a magnet at the bottom	12 minutes
On-site verification test with a gauge	§3.2.1	-6 mm diameter probing system -Mitutoyo step gauge whose calibrated length is 609,9997 mm	15 minutes
On-site verification test with a ball bar	§3.2.2	-6 mm diameter probing system -Aimess ball bar whose calibrated length is 400,0710 mm	25 minutes
On-site verification test with the tetronom	§3.3.3	-6 mm diameter probing system - tetronom { 6 bars of nominal length $L = 400$ mm and 4 stainless matte balls of nominal diameter = 38,1 mm	40 minutes

ⁱⁱⁱ Bidirectional and unidirectional length measurement are detailed in the Annex B of ISO 10360-12:2016. In short, the length endpoints measurement directions are opposite for a bidirectional measurement, whereas they coincide in a unidirectional measurement.

^{iv} Difference between the average value of the measurements and the calibrated value

^v Maximal deviation between two measurements

^{vi} L is the measured length in mm. The error is in μm though

^{vii} Average of the differences between the measured lengths and the calibrated length

^{viii} Standard deviation of the differences between the measured lengths and the calibrated length

^{ix} Difference between the maximal and the minimal values of the differences between the measured lengths and the calibrated length