



HAL
open science

Analytical input filter design in DC distributed power systems approach taking stability and quality criteria into account

Sylvain Girinon, Hubert Piquet, Nicolas Roux, Bruno Sareni

► To cite this version:

Sylvain Girinon, Hubert Piquet, Nicolas Roux, Bruno Sareni. Analytical input filter design in DC distributed power systems approach taking stability and quality criteria into account. 13th European Conference on Power Electronics and Applications (EPE'09), Sep 2009, Barcelona, Spain. pp.1-10. ⟨hal-01984468⟩

HAL Id: hal-01984468

<https://hal.science/hal-01984468v1>

Submitted on 17 Jan 2019

HAL is a multi-disciplinary open access archive for the deposit and dissemination of scientific research documents, whether they are published or not. The documents may come from teaching and research institutions in France or abroad, or from public or private research centers.

L'archive ouverte pluridisciplinaire HAL, est destinée au dépôt et à la diffusion de documents scientifiques de niveau recherche, publiés ou non, émanant des établissements d'enseignement et de recherche français ou étrangers, des laboratoires publics ou privés.



HAL Authorization



Open Archive TOULOUSE Archive Ouverte (OATAO)

OATAO is an open access repository that collects the work of Toulouse researchers and makes it freely available over the web where possible.

This is an author-deposited version published in : <http://oatao.univ-toulouse.fr/>
Eprints ID : 9254

To link to this conference :

To cite this version : Girinon, Sylvain and Piquet, Hubert and Roux, Nicolas and Sareni, Bruno. *Analytical input filter design in DC distributed power systems approach taking stability and quality criteria into account*. (2009) In: 13th European Conference on Power Electronics and Applications (EPE'09), 8-10 Sep 2009, Barcelona, Spain.

Any correspondence concerning this service should be sent to the repository administrator: staff-oatao@listes-diff.inp-toulouse.fr

Analytical Input Filter Design in DC Distributed Power Systems Approach taking Stability and Quality criteria into account

Sylvain Girinon^{1,2}, Hubert Piquet^{1,2}, Nicolas Roux^{1,2}, Bruno Sareni^{1,2}

¹ Université de Toulouse; INPT, UPS;

LAPLACE (Laboratoire Plasma et Conversion d'Energie);

ENSEEIH, 2 rue Charles Camichel, BP 7122, F-31071 Toulouse cedex 7, France.

² CNRS; LAPLACE; F-31071 Toulouse, France.

Tel.: +33 / (0) – 561.58.82.08

Fax: +33 / (0) – 561.63.88.75

E-Mail: sylvain.girinon@laplace.univ-tlse.fr

URL: <http://www.laplace.univ-tlse.fr>

Keywords

« Passive filter », « Design », « HVDC », « Embarked networks », « Stability », « Quality »

Abstract

This article presents an automated method for the sizing of filter parameters taking into account stability and quality criteria. The analytical linearized model of the system is automatically built from a circuit description. System stability conditions are firstly assessed on this model with the Routh-Hurwitz criterion. Then, filtering and damping conditions are introduced. To complete the sizing, optimization algorithms are introduced in order to minimize the energy stored in inductive and capacitive components. Simulations are performed on an embedded HVDC (High Voltage Direct Current) network onboard an aircraft (HVDC network); it associates several loads with their input filters, to validate the results obtained with the proposed method.

Introduction

For the last two decades, Distributed Power Systems (DPS) have been developed as well in embedded applications as in renewable power generation units. Indeed, the trend towards High Voltage Direct Current (HVDC) networks in aeronautical field - typically 540V DC - with “more and more electrical” aircrafts can be mentioned, where pneumatic and hydraulic systems are gradually replaced by electric ones [1]; the context of aerospace applications has been selected for this study, but our approach is very general. DC networks are also very convenient in the field of renewable energies to allow long-range transmissions between sources and consumers without the significant losses encountered with standard power AC lines [2-3] (as example: Hydro-Quebec).

HVDC networks have many advantages as for instance an easier control of the desired power in either direction. Moreover, they do not generate reactive losses. Nevertheless, DC DPS have their own stability problems; with the integration of several subsystems, there is a high chance to cause system performance degradations or even instability. A typical example is the system instability caused by a constant power load, which dynamically behaves as a negative resistance [4].

In this framework, our study focuses on the design of the input filter which is associated with each equipment. While ensuring the whole system stability, this filter has to prevent converter harmonic pollution from being re-injected on the DC network. Furthermore, we propose to minimize the energy storage in the filter (this criterion is correlated to the mass of the components, which is a very important issue for aircraft applications). Stability studies about the implementation of an equipment (with its filter) in a DC network are commonly carried out using a criterion based on impedance ratio

study, introduced by Middlebrook in 1976 [5]; we propose here a solution using the Routh-Hurwitz criterion.

This paper presents a tool based on an analytical approach in order to help designers in filter sizing, taking into account both stability and quality criteria. First, we build a linearized model of the whole system, starting from a circuit description. Then, stability is highlighted using an absolute stability criterion, well appropriated to the form of our model. Quality criteria are added to finalize the filter design. For each stage, it is possible to check the obtained results by mean of time domain simulations. Subsequently, optimization algorithms are introduced. They allow the sizing of large sets of parameters while satisfying the previous mentioned criteria.

Studied system and modelling method

A DC DPS supplying several loads is considered; the latter are mainly electric drives. Due to their efficient control, they may absorb an almost constant power, which is a well known condition for destabilization of their input filter [4]. First, the case with one drive (Permanent Magnet Synchronous Machine (PMSM) with its associated inverter connected on a HVDC bus) is presented (Fig. 1).

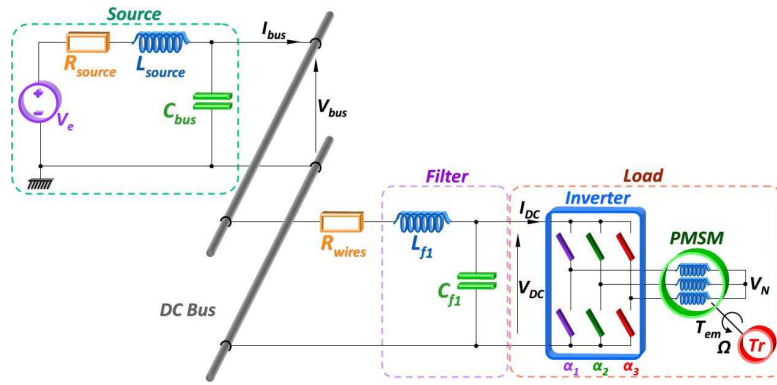

Fig. 1: First studied system

Introduction of used models for the different parts

Supply model

The voltage source is a three-phase variable frequency generator (typically $360\text{Hz} < f < 800\text{Hz}$) which supplies a DC bus through a rectifier unit. This set is modelled with an equivalent DC voltage source (V_e) in series with a resistor (R_{source}) and an inductor (L_{source}). R_{source} models any aspect of the wires (ohmic characteristic, skin and proximity effects [6]). It also figures the overlapping introduced by the rectifier [7]. If the AC/DC stage of the supply includes an auto-transformer unit, its actual characteristics are also taken into account with the R_{source} and L_{source} components. Finally, a capacitor (C_{bus}) is installed between bus terminals to smooth voltage.

Equivalent admittance modelling the frequency behaviour of the drive

PMSM electrical expressions are expressed in a Park frame (1). The mechanical speed is supposed constant because the inertia of the rotating parts is high.

$$\begin{cases} V_d(t) = R_s I_d(t) + L_d \frac{dI_d(t)}{dt} + e_d(t) \\ V_q(t) = R_s I_q(t) + L_q \frac{dI_q(t)}{dt} + e_q(t) \end{cases} \quad (1)$$

Then, the control system is associated to these equations, considering compensation loops. Indeed, the inverter is torque controlled using integral proportional regulators on (I_d) and (I_q). The analytical

expression of the load admittance is developed from the power balance between AC and DC sides of the inverter. After linearization around an operating point, equation (2) is obtained. The model has been validated comparing its Bode diagram with the one obtained with a circuit simulation software (*Saber*).

$$Y_{drive}(s) = \frac{\delta i_{DC}(s)}{\delta v_{DC}(s)} = \frac{\alpha_0 + \alpha_1 s + \alpha_2 s^2}{\beta_0 + \beta_1 s + \beta_2 s^2} \quad (2)$$

with:

$$\begin{aligned} \alpha_0 &= -GK_p V_{DC0} I_{DC0} & \beta_0 &= GK_p V_{DC0}^2 \\ \alpha_1 &= \tau_i \left[GR_s I_{q0} \left(V'_{q0} + N_p \Omega \sqrt{\frac{3}{2}} \phi_M \right) + G^2 V_{DC0} V_{q0}'^2 \right. \\ &\quad \left. - I_{DC0} (GK_p V_{DC0} + R_s) + G^2 V_{DC0} N_p \Omega \sqrt{\frac{3}{2}} \phi_M \right. \\ &\quad \left. \left(2V'_{q0} + N_p \Omega \sqrt{\frac{3}{2}} \phi_M \right) \right] & \beta_1 &= \tau_i (GK_p V_{DC0} + R_s) V_{DC0} \\ \alpha_2 &= \tau_i L_{dq} \left(GV'_{q0} I_{q0} + GN_p \Omega I_{q0} \sqrt{\frac{3}{2}} \phi_M - I_{DC0} \right) & \beta_2 &= \tau_i L_{dq} V_{DC0} \end{aligned}$$

This expression depends on the physical parameters of the PMSM (the statoric resistor (R_s), the statoric inductor (L_{dq}), the number of pole pairs (N_p) and the no load flux (ϕ_M), the regulator parameters (the proportional term (K_p) and the integral term (τ_i)) and the chosen operating point. The determination of Y_{drive} expression is detailed in [8].

Filter topologies

Two different topologies are considered in this paper. They are presented in the figures 1 and 8. The first one is a simple $L_f C_f$ filter. R_{wire} figures the ohmic characteristic of the wires between the DC bus and the input filter; the additional inductance is included in L_f . This filtering cell allows to remove the switching harmonics on the bus. The other filter topology adds a second cell for damping purpose composed by a resistor in series with a capacitor. This cell, connected in parallel, allows to compensate the PMSM negative equivalent resistance which is an instability source [4]. Moreover, this latter reduces resonance risk of the LC cell.

Automatic model building

Using the admittance model of the drive, the whole system analytical state equations are automatically derived from a circuit description of the network. A dedicated package (*Syrup* [9]), associated with the symbolic computational tool *Maple* is used for this purpose. This method proves to be very convenient as it allows to investigate any network architecture or filter topology, with a very fast model building.

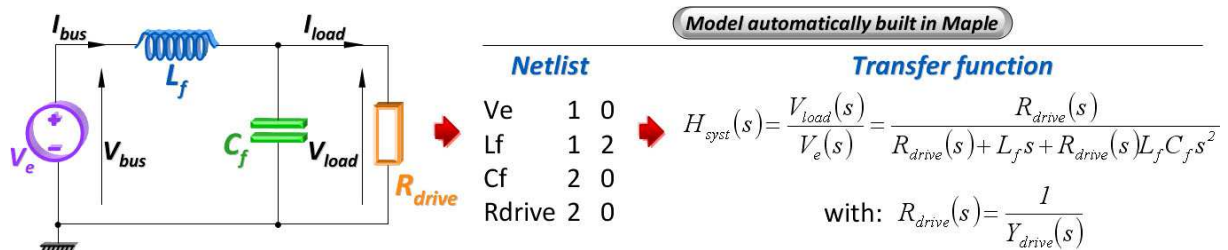

Fig. 2: Synoptic of the model building

Stability and quality criteria

Stability criterion

The main objective is to ensure the whole system stability. Therefore we apply the Routh-Hurwitz absolute stability criterion to the model established in the previous section. Stability is discussed according to L_{f1} and C_{f1} filter parameters (Fig.1). Several values are varied for both parameters and the Routh-Hurwitz criterion is applied on each point. In this case, the obtained result is presented in figure 3: two areas associated with stable and unstable conditions are separated by the stability limit. This result takes into account all the system elements. In order to check this abacus, time domain simulations (*Saber* software) are performed for different sizings, noted “1” and “2” (Fig.3).

The chosen pattern is the following: the system is initially placed in steady state condition computed in the case of a stable design. Then, a step is applied on the rectified generator voltage (V_g) from 540 to 550 Volts. The stability is evaluated by mean of the V_{DC} voltage. Waveforms on figure 4 are in accordance with the design points highlighted on the abacus.

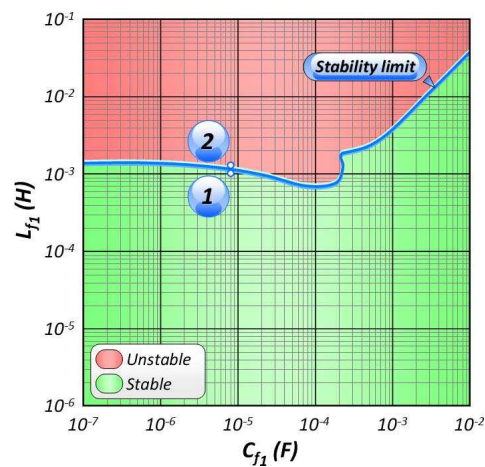

Fig. 3: Abacus with stability criterion

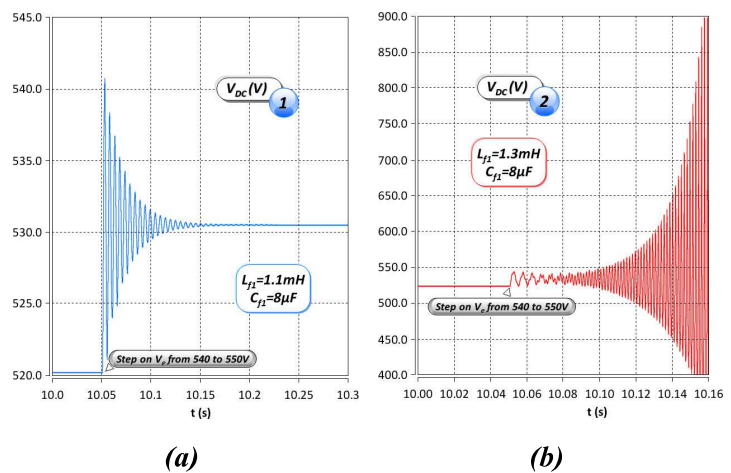

Fig. 4: V_{DC} voltage evolution
 (a) $L_{f1} = 1.1\text{mH}$ and $C_{f1} = 8\mu\text{F}$ (stable area)
 (b) $L_{f1} = 1.3\text{mH}$ and $C_{f1} = 8\mu\text{F}$ (unstable area)

Filter design

Stability criterion has reduced the design domain for L_{f1} and C_{f1} to the stable area plotted in figure 3. However, this result is not sufficient, as it is not taking into account the system dynamic. This is why quality criteria will now be introduced in order to finalize the filter sizing. They are illustrated on the simple case used previously (Fig.1). The LC filter design method has to abide by two criteria: the cut-off frequency and the damping factor.

Filtering criterion

For filtering purpose, we first consider the cut-off frequency of the filter. On the abacus (Fig.3), this quantity defines a straight line (logarithmic scales). It introduces a first relationship between the values of the inductor and capacitor parameters. In the example of figure 5, a value of $f_{\text{cut-off}} = f_{\text{switching}}/10$ is chosen.

Transient response

In a second step, we want to ensure a minimal damping of the V_{DC} voltage. Thus, LC filter parameters must be sized so that the dominant pole damping is equal to or even higher than the minimal chosen damping factor. The choice of this criterion is similar to quality standards used by aeronautic designers (MIL-STD 704). Indeed, to fulfil signal envelops defined in these standard is equivalent to specify a minimal damping.

Poles and their associated damping coefficients are numerically computed from the whole system model, for LC values of which points belong to the cut-off line. The starting point is taken from the intersection point between the stability limit and the cut-off line. Algorithm stops when filter parameter values fulfil our requirements. Abacus so completed is presented figure 5 for a minimal damping of 0.06.

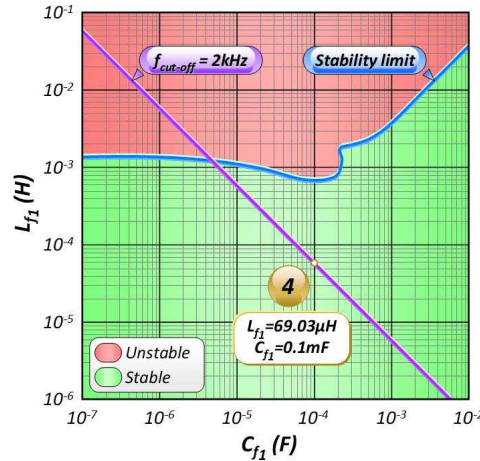

Fig. 5: Abacus with the cut-off frequency line ($f_{cut-off} = 2kHz$) and with filter parameter values for a damping factor equal to 0.06

Method Validation

Figure 6 presents the frequency analysis performed after time domain simulation; establishing the accuracy of the chosen harmonic softening. Moreover, voltage at the load terminals with figure 5 conditions is plotted figure 7: obtained damping validates our filter sizing.

To conclude on this part, the three developed criteria used simultaneously end up with a complete filter sizing. Nevertheless, abaci limit the number of dealt parameters: hence we have chosen to entrust this study to optimisation algorithms.

Optimisation algorithms

The previous method allows to automatically choose two parameters according to stability and quality criteria; the approach can be performed on a graphical basis, once the abacus is available. In order to increase the number of handled parameters, optimization algorithms are introduced.

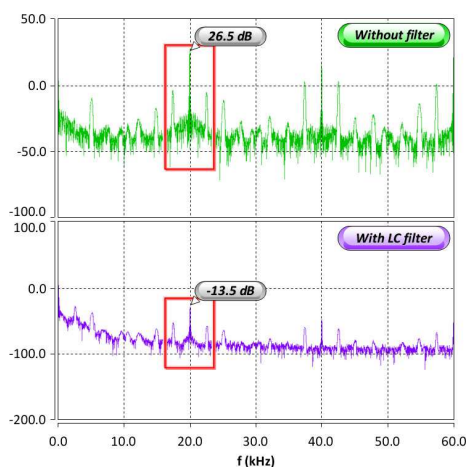

Fig. 6: Cut-off frequency allows to reduce switching fundamental harmonics of 40dB.

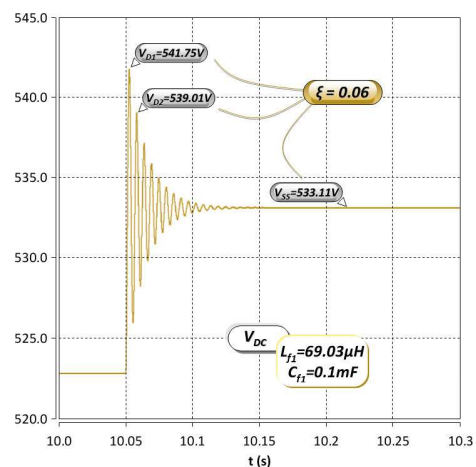
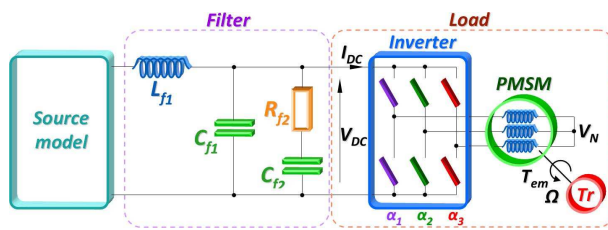

Fig. 7: V_{DC} voltage evolution with Fig.6 values: simulated damping factor is equal to 0.06

The criteria are translated into constraints; and the used convergence criterion is the minimization of storage energy in inductive and capacitive components. Two different kinds of algorithms have been used: the first is based on gradient convergence; the second one is a genetic algorithm (GA). In both cases, the obtained results from those algorithms are compared to the ones obtained from the abacus method, considering the system presented in figure 8.

The source model remains the same. The purpose is to size the first filter cell composed by an inductor (L_{f1}) and a capacitor (C_{f1}). Others filter parameters (R_{f2} and C_{f2}) are fixed according to the following requirements: R_{f2} is used to compensate the equivalent negative resistance of the drive and C_{f2} is used to reduce the resonance effect brought by the LC filtering cell. Thus, this branch behaves as a positive resistor at the filter cut-off frequency.

Applying the sizing tool with the stability and quality criteria defined previously, the abacus (Fig. 9) is plotted.



P	30kW	PMSM mechanical power
f_{sw}	20kHz	Switching frequency
Ω	3700.8 rad.s ⁻¹	Rated mechanical speed

Fig. 8: Second equipment considered in this study

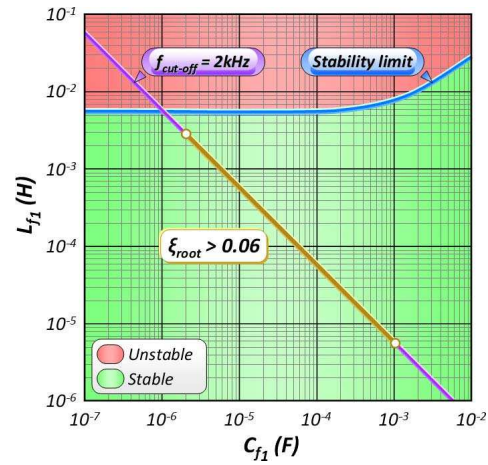

Fig. 9: Obtained abacus for the second equipment

A set of points, regrouped on the yellow line (thick line), fulfils the requirements. This study is now processed with algorithms.

Gradient algorithm

First, an algorithm based on the Hessian of the convergence criterion is used (Fig.10). The *Matlab* function “*fmincon*”, used for this purpose, attempts to find a constrained minimum of a scalar function of several variables starting at an initial estimate. It is possible to drive the algorithm toward different optima using additional weightings. These weightings allow to minimize more or less some parameters according to the wish of the designer. For example in figure 10, the optimum obtained with weightings minimizes more the inductance compared with the capacitance.

All the found optima belong to the line obtained with abacus method (Fig.9). So, the proposed values well respect the laid down constraints; in other words, this first kind of algorithm gives correct results. Nevertheless, only the optimum is returned by the algorithm; and consequently, the designer does not have any alternative. He cannot choose a solution less satisfactory according to the minimization criterion, but more interesting from a realization point of view, which is very difficult to quantify. This is the reason why GA are now introduced.

Genetic algorithm

Subsequently, a crowding based GA is used (Fig.11) [10]. This kind of GA has the distinctiveness to look for several solutions in the given excursion windows (within the bounds). The objective here is to widen the result spectrum in order to increase the possible choices for the designer.

We decide to use the Restricted Tournament Selection (RTS) algorithm, which adapts a tournament selection for multimodal optimization [11]. RTS initially selects two elements from the population to undergo crossover and mutation. After recombination, a random sample of w individuals is taken from the population. Following this way, each offspring competes with the closest sample element. The winners are inserted into the population. This procedure is repeated $N/2$ times per generation (N denoting the population size).

The objective function combines minimization criterion to constraints weighted with a coefficient (3).

$$f_{obj} = \sum_i P_i \left(\frac{X - X_{min}}{X_{max} - X_{min}} \right)^2 + 10^5 (\text{constraints}) \quad (3)$$

This function aims at the minimization of the vector X parameters, which are ranged from X_{min} to X_{max} . All its terms are normalized in order to avoid scaling problems. The multiplier coefficient (10^5) is chosen heavy, so that when one constraint is disregarded, f_{obj} becomes heavy too. In these conditions, the solution is very penalized and so, not kept by the algorithm.

RTS finds several solutions composing the domain represented with blue line (between points marked “4” and “7”) in the figure 11. To note that weightings used in this case are: 70% for L_{f1} and 30% for C_{f1} .

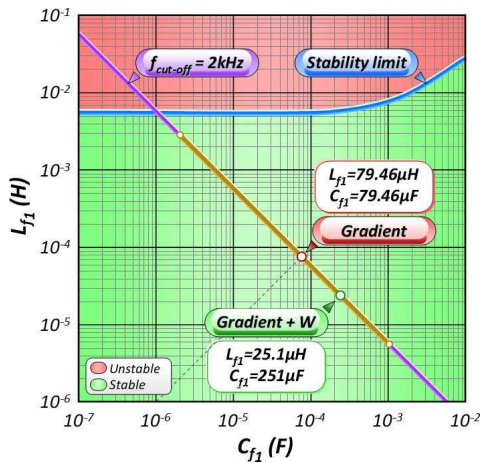

Fig. 10: Results obtained using **Gradient** algorithm

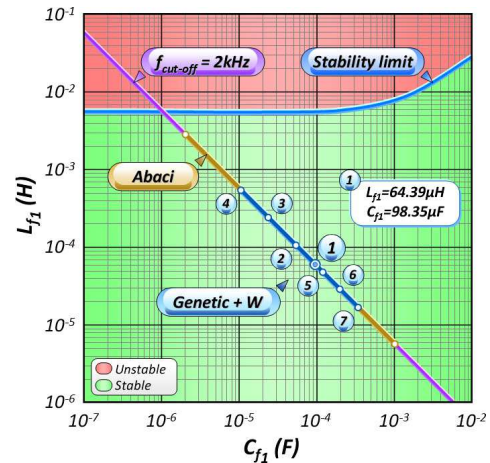

Fig. 11: Results obtained using **Genetic** algorithm

The value of the objective function is associated to each found solution. So, the designer can compare the obtained results, and fix the filter parameter values among the best possible combinations. In the table I, the f_{obj} values are given for the points marked from “1” to “7” on figure 11. They are also graphically represented in figure 12.

Those results well illustrate the possibilities of this algorithm, which gives a set of solution, quantified with the f_{obj} value.

Outcomes

In both case, found results are in accordance with the ones obtained from the previous method. Optimization algorithms allow the sizing of more than two parameters, associating the minimization of energy storage to the stability and quality constraints. Moreover, RTS GA returns several possible solutions which can be qualified according to the objective function value. It will be used in the following part on more complex systems.

Table I: f_{obj} values for points of the Fig.11

Point	L_{f1} (μH)	C_{f1} (μF)	f_{obj}
1	64.39	98.35	$- 5.789 \cdot 10^{-7}$
2	110.79	57.23	$- 9.556 \cdot 10^{-7}$
3	231.91	27.50	$- 3.784 \cdot 10^{-6}$
4	516.18	12.72	$- 1.865 \cdot 10^{-5}$
5	49.85	127.23	$- 6.582 \cdot 10^{-7}$
6	36.70	177.83	$- 1.041 \cdot 10^{-6}$
7	17.41	374.75	$- 4.232 \cdot 10^{-6}$

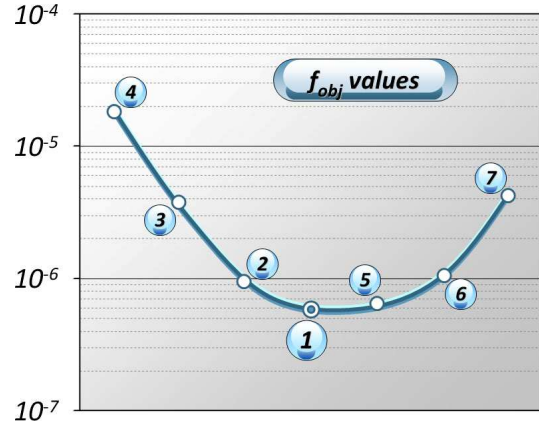
**Fig. 12:** Graphic representing the f_{obj} value according the chosen point

Study of more complex system, considering more than 2 parameters

Complete sizing of the second filter topology

First, we consider the previous system (Fig.8) where all filter parameters are unknown. Constraints are the following:

- System has to be stable;
- $f_{cut-off(LC)} \leq \frac{f_{switching}}{10}$;
- $f_{cut-off(RC)} \leq f_{cut-off(LC)}$;
- Dominant pole damping factor ≥ 0.06 .

The convergence criterion includes the minimization of L_{f1} , C_{f1} , C_{f2} and the maximization of R_{f2} . Inductance and capacitance range from 10^{-7} to 10^{-1} , and resistance from 10^{-4} to 10^{-2} . Usually, R_{f2} is sized considering the drive as an equivalent negative resistor (constant power load). This case corresponds to the worst conditions for stability point of view. In our case, Y_{drive} expression (2) includes all drive information (both the frequency behaviour and the equivalent negative resistor): so R_{f2} is more accurately sized. Weightings used in this case are: 50% for L_{f1} , 10% for C_{f1} , 20% for R_{f2} and 20% for C_{f2} .

RTS returns the results presented in Table II and time domain simulation gives the waveform plotted in figure 13.

Voltage evolution illustrates the stable behaviour of the system. Measured damping factors are equal to 0.184 (higher than the waited damping equal to 0.179). So, simulation results meet the chosen specifications.

Table II: Obtained results for the system of Fig.8

Solution found	Associated constraints
$L_{f1} = 53.22\mu H$ $C_{f1} = 118.98\mu F$ $R_{f2} = 100\Omega$ $C_{f2} = 1.061mF$	Highest pole real part = $-311.65 (<0)$ $f_{c1} = 2000Hz$ $f_{c2} = 1500Hz$ Damping of dominant pole = 0.179

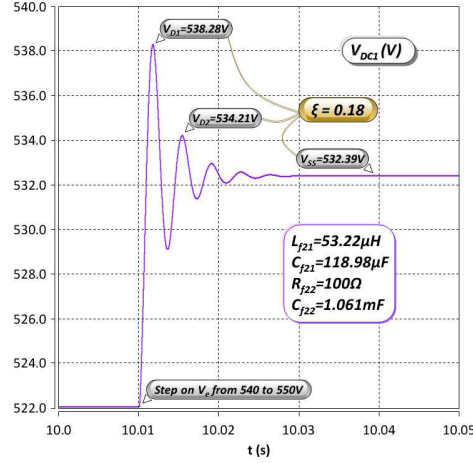

Fig. 13: V_{DC} voltage evolution with Table II values

Sizing of several filters in a network context

System presented in figure 15 is now considered. It consists of two equivalent loads connected on the same DC bus through two different filter topologies. The purpose is to automatically size these filters, with the same conditions than previously. The set of unknown parameter is $\{L_{f11}, C_{f11}, L_{f21}, C_{f21}, R_{f22}, C_{f22}\}$.

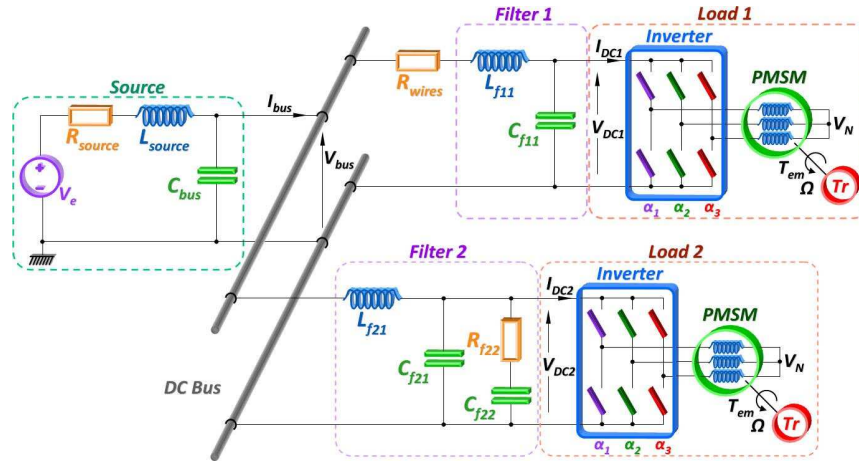

Fig.14: Studied network composed by two loads

After computation, we obtained the following results (Table III). Weightings used in this case are: 25% for L_{f11} , 10% for C_{f11} , 25% for L_{f21} , 10% for C_{f21} , 15% for R_{f22} and 15% for C_{f22} .

Table III: Obtained results for the system of Fig.14

Optimum found	Associated constraints
$L_{f11} = 61.53\mu H$ $C_{f11} = 102.94\mu F$	Highest pole real part = -267.36 (<0) Damping of dominant pole = 0.171
$L_{f21} = 64.80\mu H$ $C_{f21} = 97.75\mu F$ $R_{f22} = 100\Omega$ $C_{f22} = 1.416\mu F$	$f_{\text{cut-off LC1}} = 2000\text{Hz}$ $f_{\text{cut-off LC2}} = 2000\text{Hz}$ $f_{\text{cut-off RC2}} = 1124\text{Hz}$

Time domain simulation gives the waveforms plotted in figure 15. They represent the input voltage evolution of both drives: V_{DC1} and V_{DC2} (Fig.14), which are in agreement with the requirements; thus ensuring the validity of this method.

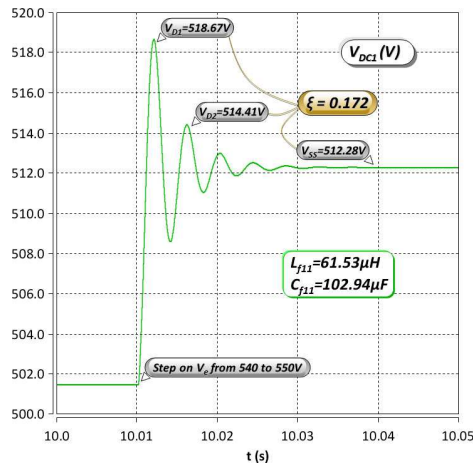

(a) Load n°1 + filter topology n°1 - V_{DC1}

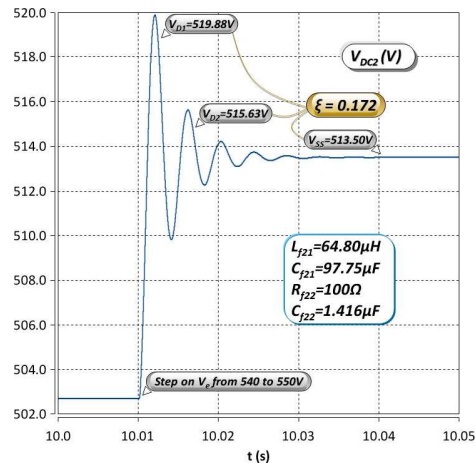

(b) Load n°2 + filter topology n°2 - V_{DC2}

Fig.15: Input voltage evolution after a step applied on V_e

Conclusion

To conclude, a tool allowing the filter sizing is presented. It attempts to minimize the energy storage in inductive and capacitive components while respecting stability and quality constraints. The first step is the automatic model building from a circuit description of the system. Then, the Routh-Hurwitz criterion is applied on the model to assess system stability. Quality criteria are finally introduced in order to complete the filter sizing. Thus, the filtering function through the cut-off frequency and the damping factor considering the dominant pole are highlighted. The use of RTS, a crowding based GA, gives several domains among the best solutions. The constraints linked to the realization and the convergence criterion value allows to guide the designer in the choice of its parameters.

This research is being conducted in the frame of the MOET project (More-Open Electrical Technologies), a FP6 European Integrated Project.

References

- [1] J.A. Weimer, "The role of electric machines and drives in the more electric aircraft", IEEE Machine and Drive Conference, 2003
- [2] A. Rufer, "Today's and Tomorrow's Meaning of Power Electronics within the Grid Interconnection", Keynote EPE 2007 Aalborg, n°957
- [3] F. Blaabjerg, Z. Chen, and S. B. Kjaer, "Power electronics as efficient interface in dispersed power generation systems," IEEE Trans. Power Electron., vol.19, no.5, pp.1184-1194, Sep. 2004.
- [4] J. Morren, S.W.H. de Haan, J.A. Ferreira, "(De-)Stabilising Effect of Power Electronic Interfaced DG Units in Distribution Networks", Proc. EPE 2005 Dresden.
- [5] X. G. Feng, J. J. Liu, and F. C. Lee, "Impedance specifications for stable dc distributed power systems," IEEE Trans. Power Electron., vol. 17, pp. 157-162, Mar. 2002.
- [6] P. L. Dowell, Effects of eddy currents in transformer windings. Proceedings IEE. (UK), August 1966, vol. 113, no. 8.
- [7] Paice, "Power electronics converters harmonics – multipulse methods for clean power," IEEE Press, 1996.
- [8] S. Girinon, C. Baumann, H. Piquet and N. Roux, "Analytical modeling of the input admittance of an electric drive for stability analysis purposes," Eur. Phys. J. Appl. Phys. 47, 11101 (2009)
- [9] Joseph Riel, <http://www.maplesoft.com/applications/view.aspx?SID=4680>
- [10] B. Sareni, L. Krähenbühl, "Fitness sharing and niching methods revisited", IEEE Trans. on Evolutionary Computation, Vol. 2, n°3, pp. 97-106, 1998
- [11] G. Harik, "Finding multimodal solutions using restricted tournament selection," in L.J. Eshelman (Ed.), Proceedings of the 6th International Conference on Genetic Algorithms (ICGA6), San Francisco, CA: Morgan Kaufmann, pp. 24-31, 1995.