



HAL
open science

Modeling hygrothermal recovery of wood in relation with locked-in strains during tree life

Sandrine Bardet, Joseph Gril

► **To cite this version:**

Sandrine Bardet, Joseph Gril. Modeling hygrothermal recovery of wood in relation with locked-in strains during tree life. 8th Plant Biomechanics International Conference, Nov 2015, Nagoya, Japan. . hal-01982483

HAL Id: hal-01982483

<https://hal.science/hal-01982483>

Submitted on 15 Jan 2019

HAL is a multi-disciplinary open access archive for the deposit and dissemination of scientific research documents, whether they are published or not. The documents may come from teaching and research institutions in France or abroad, or from public or private research centers.

L'archive ouverte pluridisciplinaire **HAL**, est destinée au dépôt et à la diffusion de documents scientifiques de niveau recherche, publiés ou non, émanant des établissements d'enseignement et de recherche français ou étrangers, des laboratoires publics ou privés.

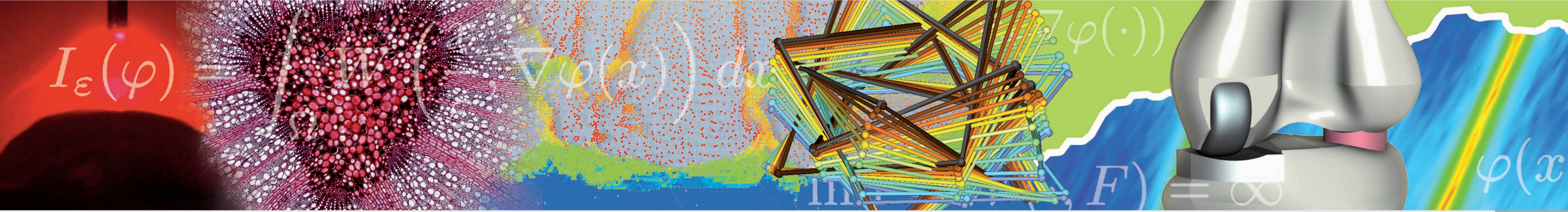

Modeling hygrothermal recovery of wood in relation with locked-in strains during tree life

Sandrine Bardet, Joseph Gril

Laboratoire de Mécanique et Génie Civil (LMGC), Université de Montpellier, CNRS, Montpellier, France

sandrine.bardet@umontpellier.fr

Where do locked-in strains come from ?

1. Cell maturation process

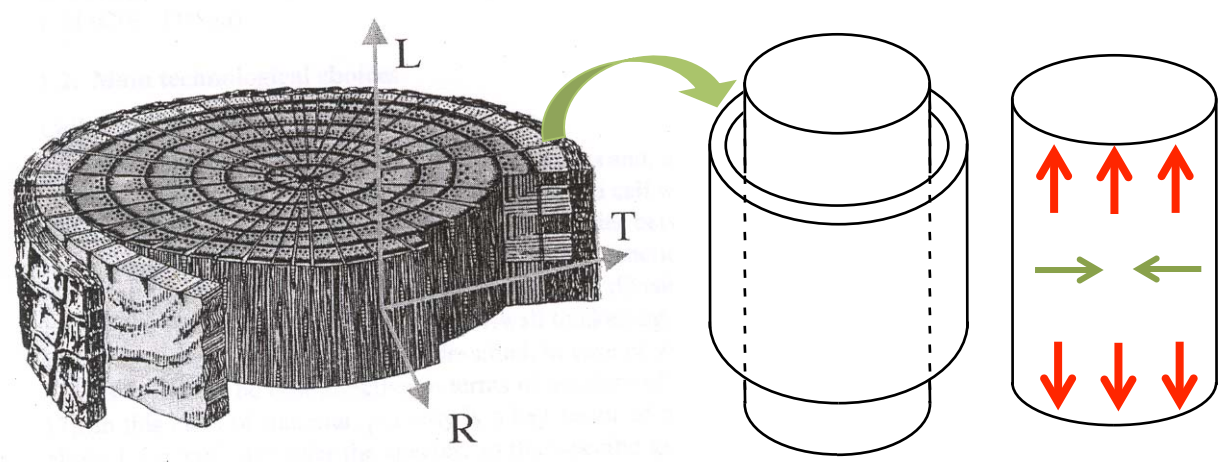

- last step of the genesis of a wood cell
- increase of rigidity
- tendency to shrink along the fibre and expand transversally
- deformations are prevented by previously formed layers

> longitudinal tension and tangential compression

+

2. Loading history during tree life

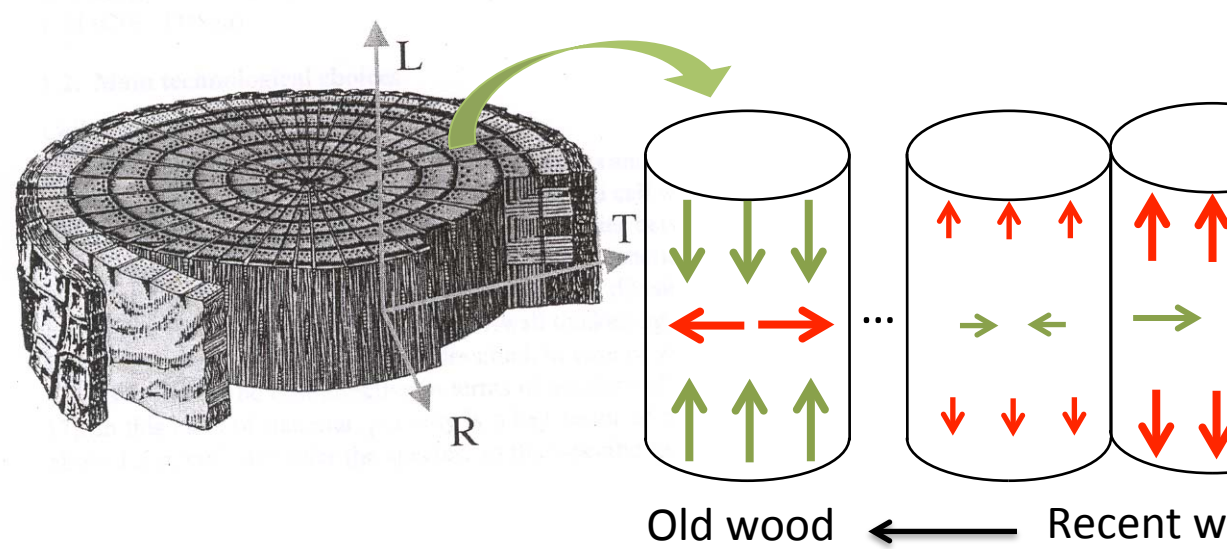

- formation of layers : redistribution of tangential stresses
 - successive disposition of concentric layers
 - growth stress depends on radial position
- inversion of stress (T: compression near the bark, tension near the pith)

> pre-stress level of the wood in the tree depends on the direction and the age of wood

How to release locked-in strains?

1. Elastic part = short-term viscous strains

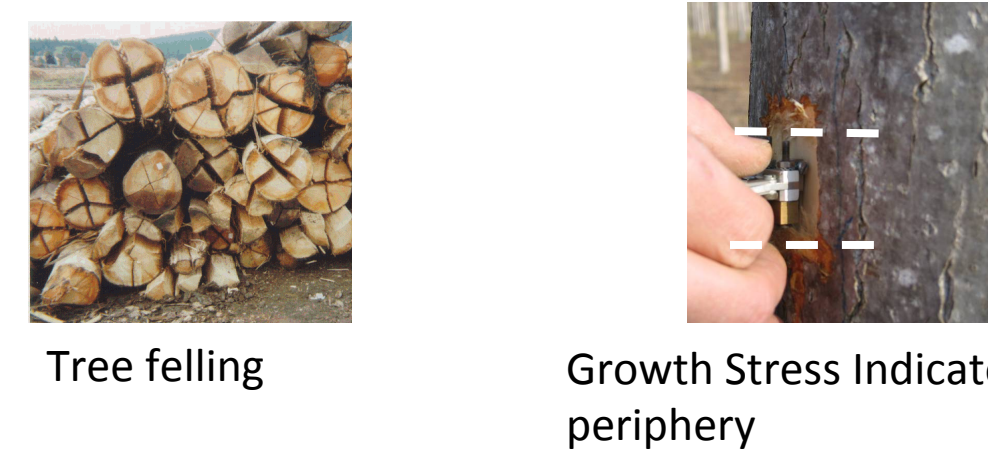

2. Viscous part = long-term viscous strains

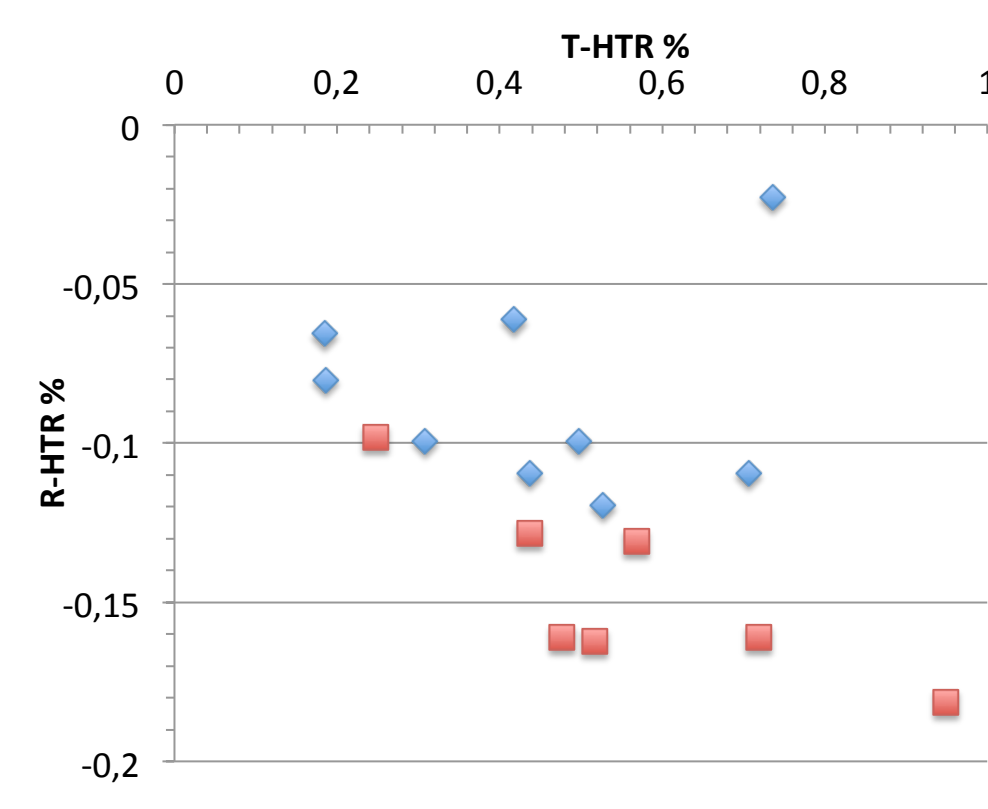
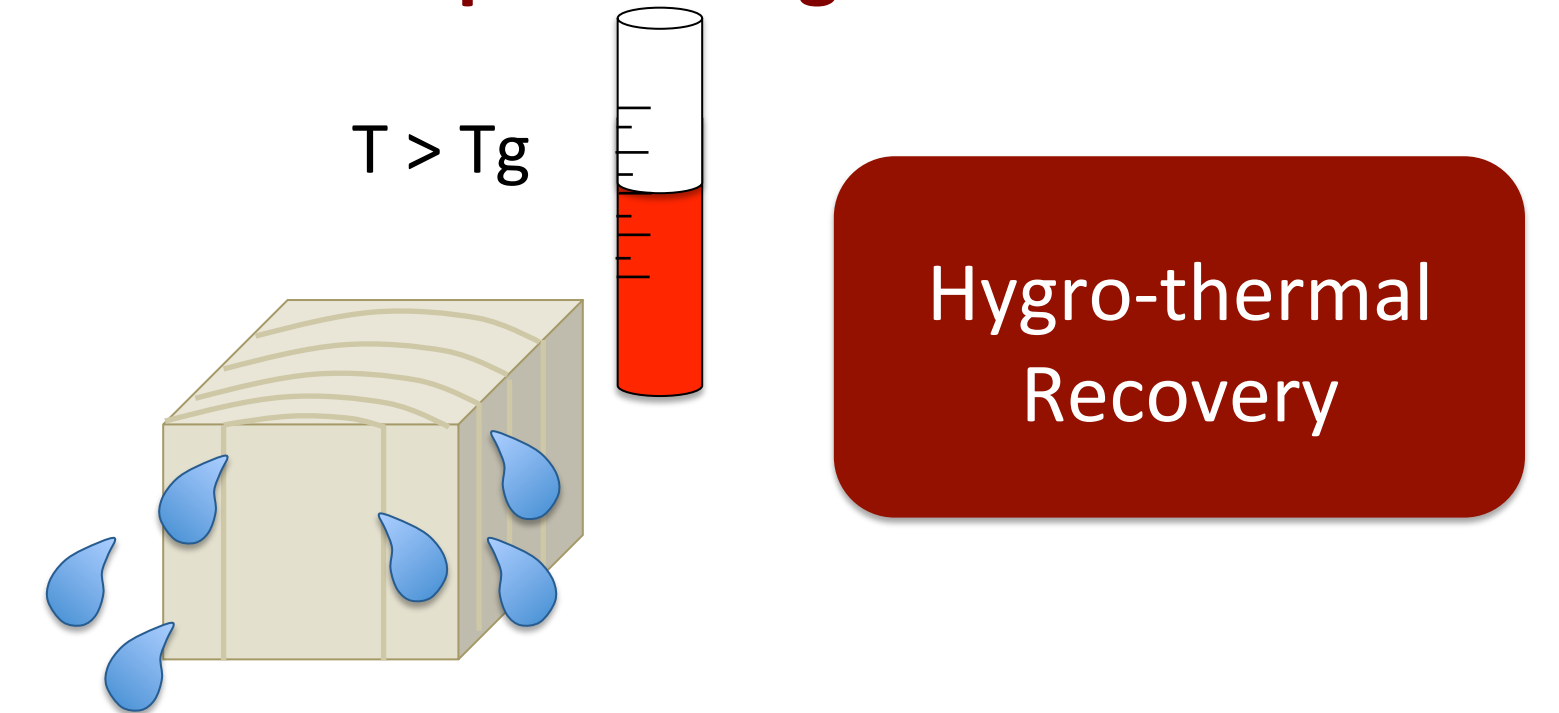

Radial HTR against tangential HTR from literature

HTR in T and R direction in the literature :

Reference	Duration (min)	T °C	Species
Koehler, 1933	1440	89	Pine, birch, oak
Mac Lean, 1952	30-45	99	Maple, beech, poplar, oak, hickory, douglas, fir, spruce,
Kubler, 1959	150	95	Beech
Grzeczynsky, 1962	60	100	Beech
Yokota and Tarkow, 1962	180	80	Sitka spruce
Sasaki and Okuyama, 1983	60	100	Sugi
Gril et al., 1983	60	90	Jujube tree

Radial and tangential HTR conditions from literature

Experimental study

Specimen : Hinoki (*Chamaecyparis obtusa*)

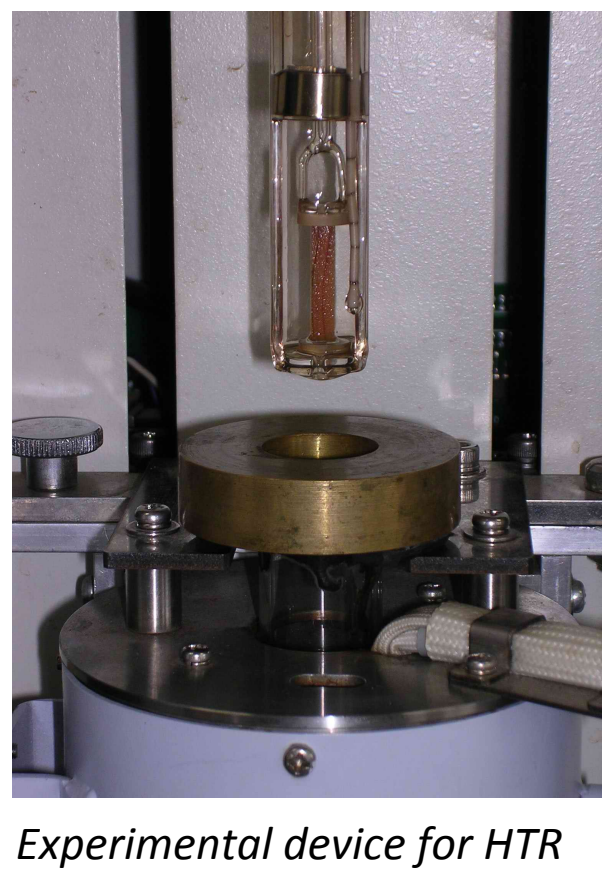
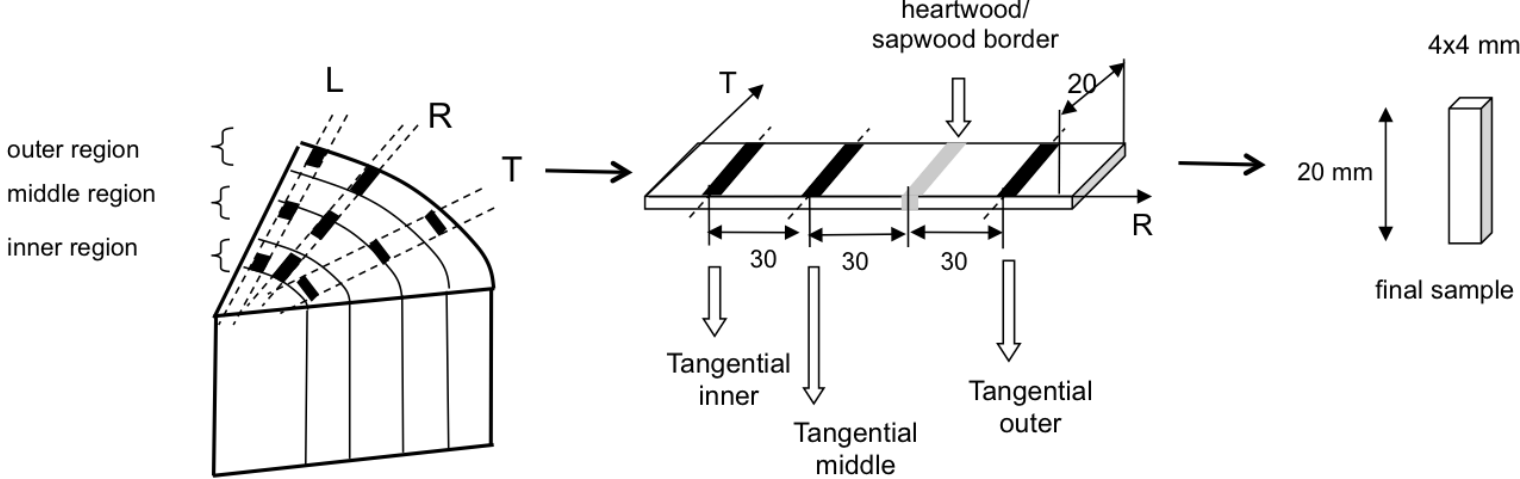

- TMA with compression attachment,
- slight initial compression stress (equivalent to 5g)
- sample immersed into water; temperature is increased to 90–95°C during 2 hours, then specimen is cooled down
- dimensions of the sample are recorded with an accuracy of 0,01 µm.

Heating of green wood involves a complex set of deformation processes :

- reversible deformation
 - standard thermal expansion
 - shrinkage due to a decrease of moisture content when temperature increases
- irreversible deformation (+0,5% to 1% in T direction)
 - viscoelastic recovery of growth stains generated after maturation
 - “true” HTR of maturation strain

Separating HTR from reversible deformation

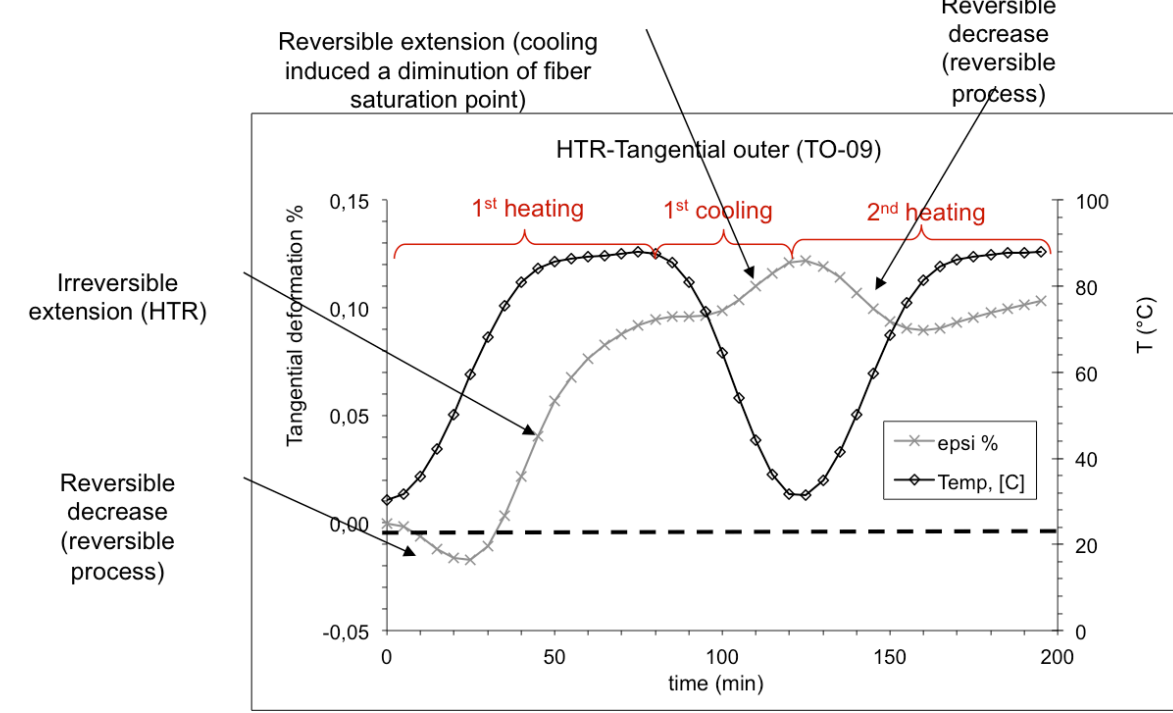

Evolution of tangential deformation against time

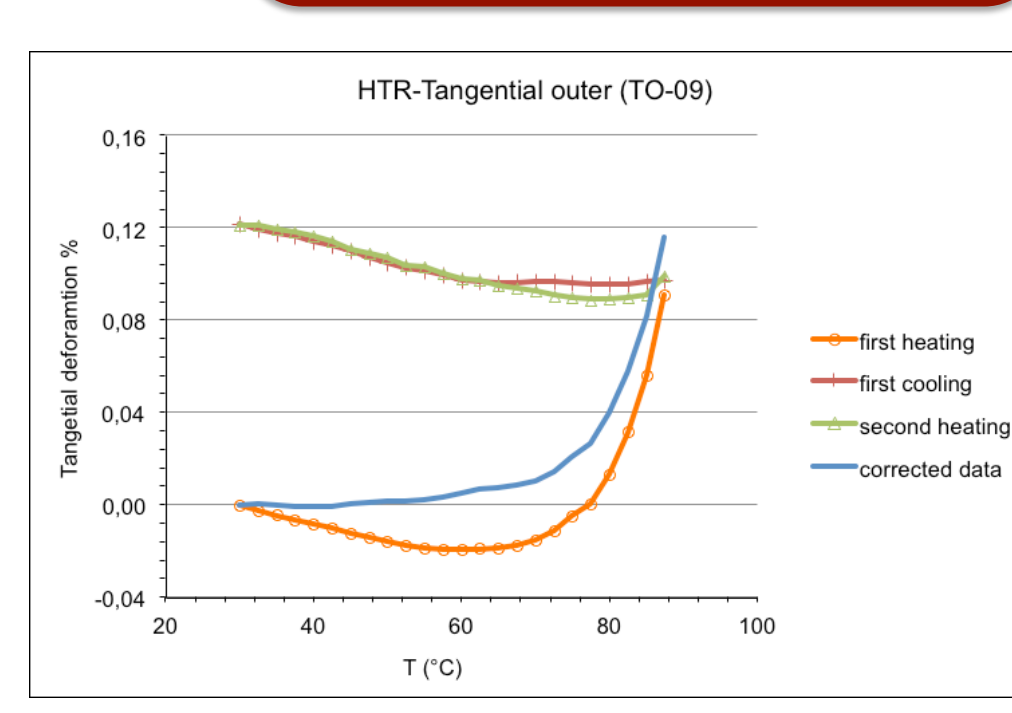

Evolution of tangential deformation against temperature : total strain, thermal reversible strain, corrected irreversible part

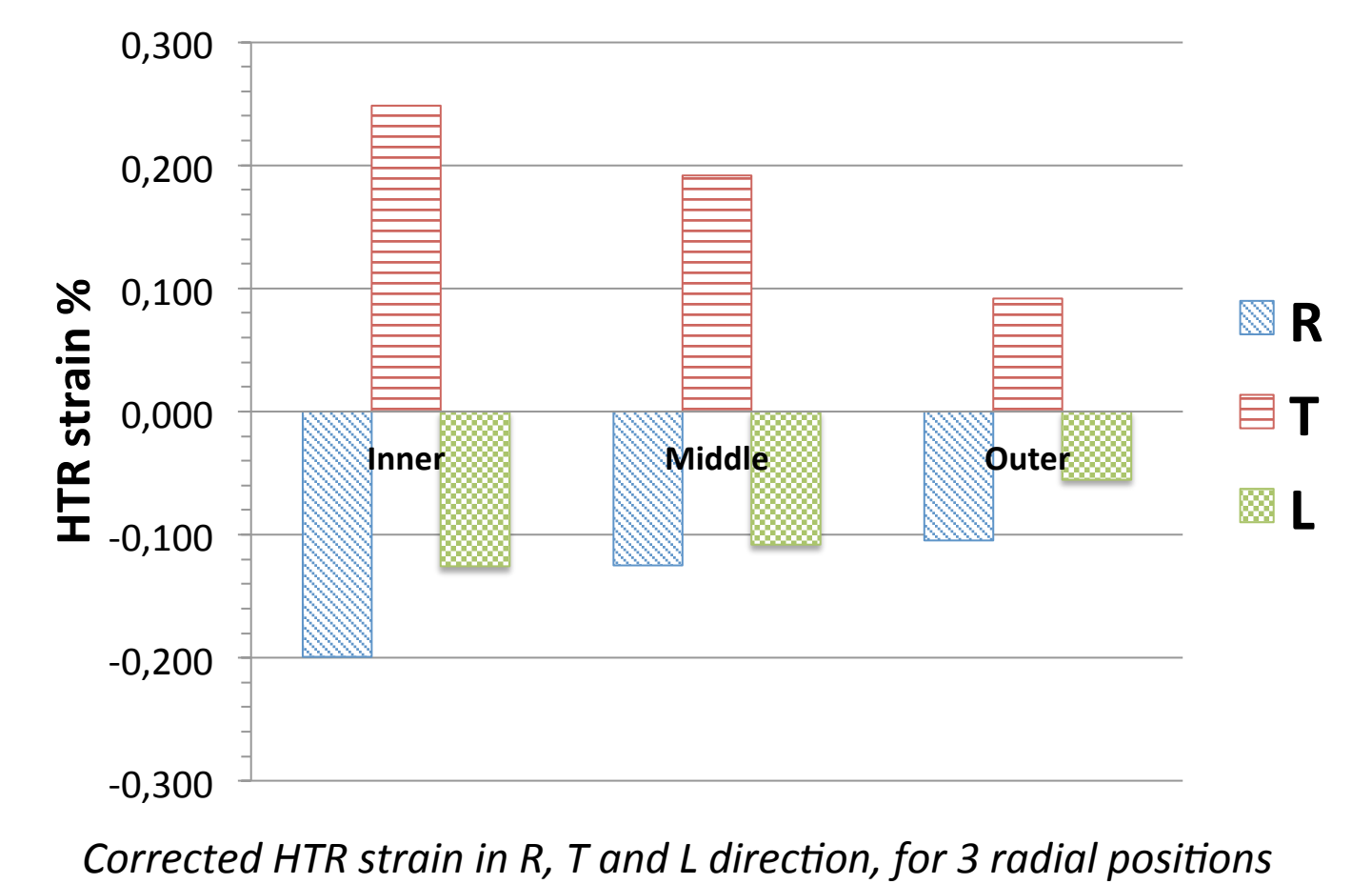

Corrected HTR strain in R, T and L direction, for 3 radial positions

The results are not consistent with the growth stress profile which is usually proposed. In T direction, we expect the older wood (near the pith) to be under tension!

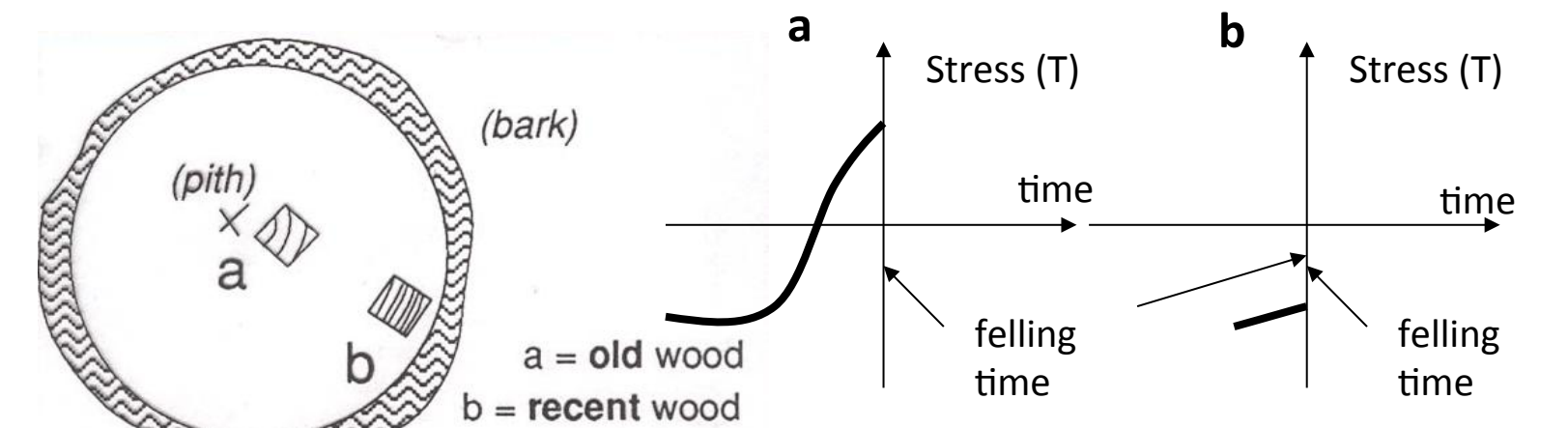

Growth stress profile for old and recent wood : inversion of stress with the age of wood

Modeling

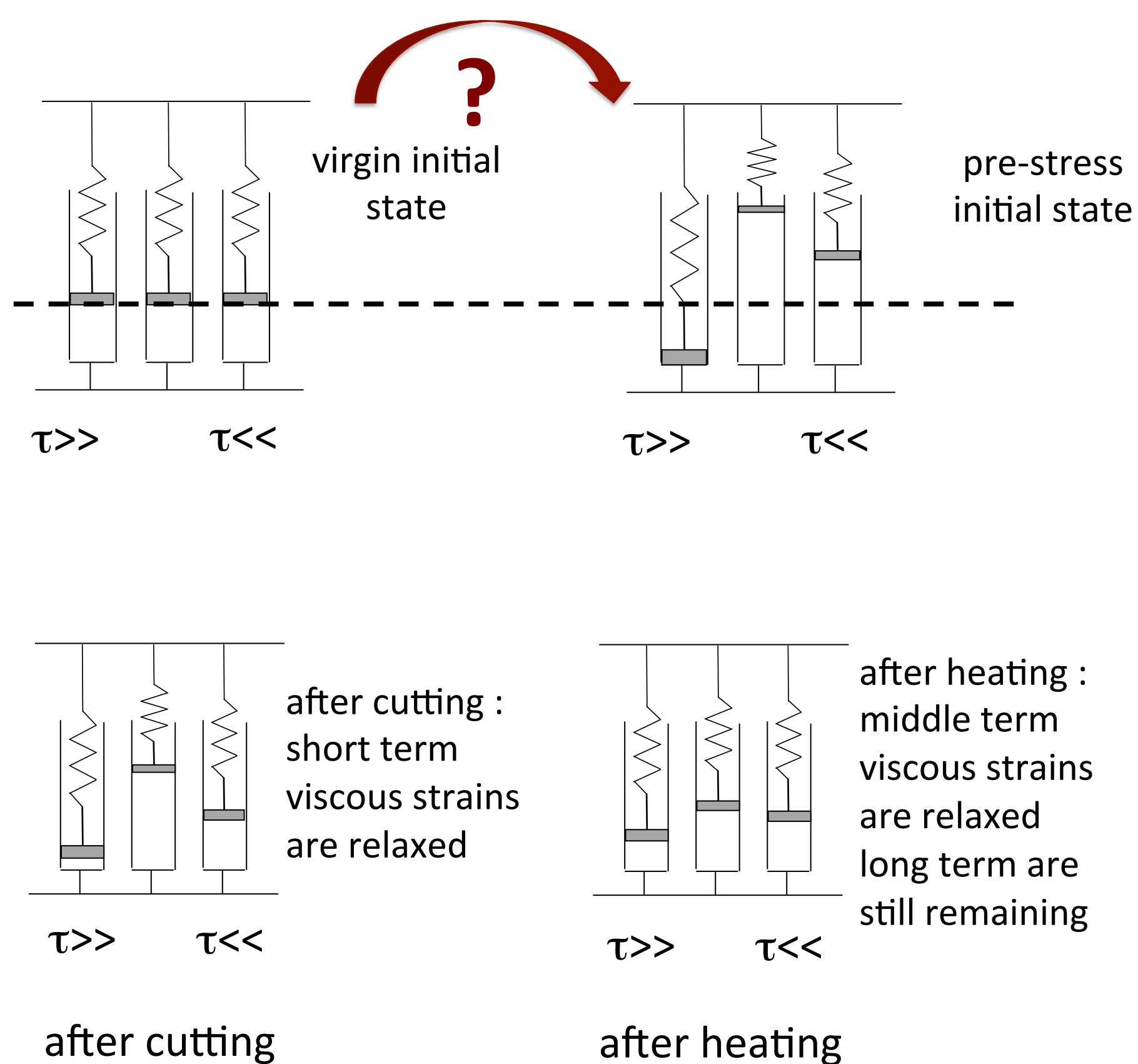

Hypothesis : rheological similarity between maturation and HTR

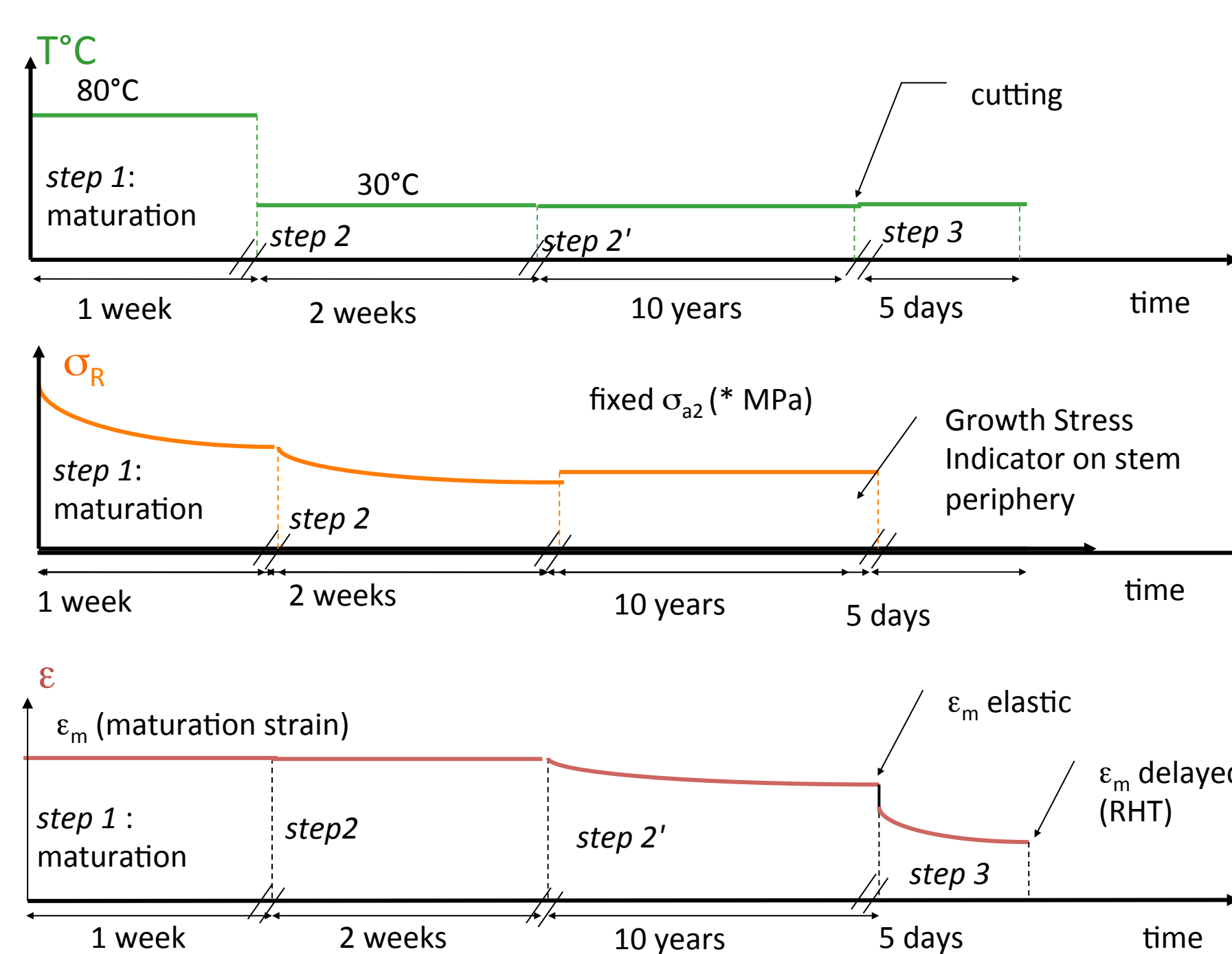

Different steps to simulate the mechanical loading of wood during tree life

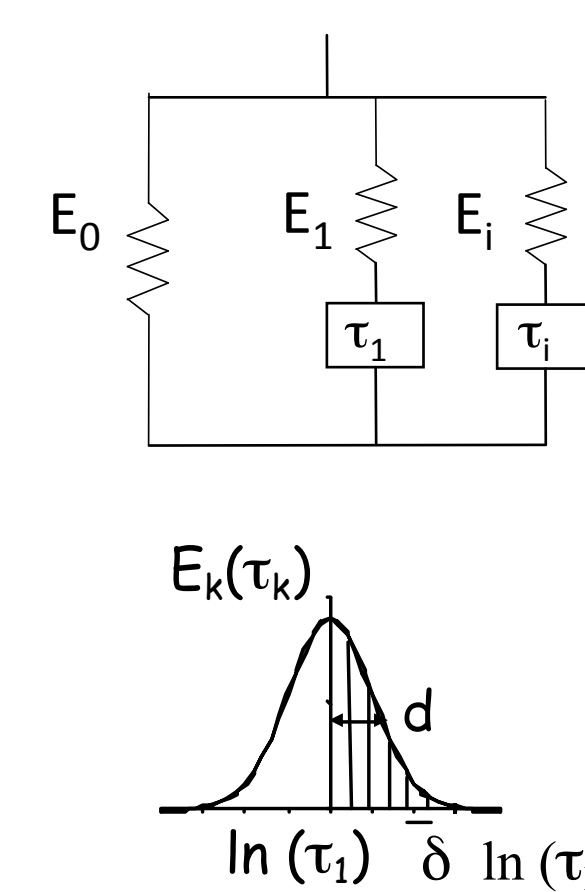

$$\sigma = \sigma_1 = \dots = \sigma_i$$

$$\epsilon = \epsilon_1 + \dots + \epsilon_i$$

$$\sigma_i = E_i (\epsilon_i - x_i)$$

$$\frac{dx_i}{dt} = \frac{\epsilon_i - x_i}{\tau_i}$$

pre-stressed model : $x_i \neq 0$ for $t=0$

Work in progress :

- Calculation of the strain in each viscous branch
- Simulation of a thermal treatment to simulate HTR

This work on HTR is the subject of an application for a DAIKO Foundation fellowship and a JSPS/CNRS fellowship for a scientific mission at Nagoya University in 2016.

