



HAL
open science

Numerical simulation of in - line mixers

Pascal Guiraud, Anne-Marie Billet, Laurence Etcheto, Joël Bertrand

► **To cite this version:**

Pascal Guiraud, Anne-Marie Billet, Laurence Etcheto, Joël Bertrand. Numerical simulation of in - line mixers. *Computers & Chemical Engineering*, 1993, 17, pp.S511-S516. 10.1016/0098-1354(93)80274-Q. hal-01980482

HAL Id: hal-01980482

<https://hal.science/hal-01980482>

Submitted on 14 Jan 2019

HAL is a multi-disciplinary open access archive for the deposit and dissemination of scientific research documents, whether they are published or not. The documents may come from teaching and research institutions in France or abroad, or from public or private research centers.

L'archive ouverte pluridisciplinaire **HAL**, est destinée au dépôt et à la diffusion de documents scientifiques de niveau recherche, publiés ou non, émanant des établissements d'enseignement et de recherche français ou étrangers, des laboratoires publics ou privés.







Open Archive Toulouse Archive Ouverte

OATAO is an open access repository that collects the work of Toulouse researchers and makes it freely available over the web where possible

This is an author's version published in: <http://oatao.univ-toulouse.fr/21531>

Official URL: [https://doi.org/10.1016/0098-1354\(93\)80274-Q](https://doi.org/10.1016/0098-1354(93)80274-Q)

To cite this version:

Guiraud, Pascal  and Billet, Anne-Marie  and Etcheto, Laurence  and Bertrand, Joël  *Numerical simulation of in — line mixers.*(1993) *Computers & Chemical Engineering*, 17. S511-S516. ISSN 0098-1354

Any correspondence concerning this service should be sent to the repository administrator: tech-oatao@listes-diff.inp-toulouse.fr

NUMERICAL SIMULATION OF IN - LINE MIXERS

P. GUIRAUD, A.M. DUQUENNE, L. ETCHETO and J. BERTRAND

LGC (URA CNRS 192), E.N.S.I.G.C., chemin de la Loge,
F-31078 Toulouse Cedex, France.

ABSTRACT

Simulations of 3D fluid flows and mixing have been performed inside in-line mixers (a tee mixer and an axisymmetric mixer), for a single phase flow, in turbulent conditions. The 3D velocity fields are used to calculate the mixing phenomena inside of this mixers and the driving forces of mixing are brought to the fore. The mean concentration fields are presented. Emphasis is put on the great importance of the post processing, because the raw results are impossible to examine in the case of a 3D calculation.

KEYWORDS

Mixing : In-line mixers ; Turbulence : Simulation of complex fluid flows ; Post-processing

INTRODUCTION

Mixing is often a necessary step in the processes of material transformation. It can be considered as a full Chemical Engineering unit operation, and also, it is the first stage of chemical reactions. Rate and selectivity of some reactions closely depend upon the carrying out of mixing, especially when the characteristic reaction time is smaller than the characteristic diffusion time. More generally, mixing allows contacts to be performed in transfer phenomena.

Mixing consists in bringing two fluids initially stored apart (in two tanks or two pipes for instance), in a "mixture" inside of which each elementary volume holds the same proportion of each fluid. In turbulent conditions, the mixing process is composed of convection, turbulent diffusion and molecular diffusion. The movements of the greater scales cut out the fluid elements and disperse them. Then, the small vortices of the turbulence stretch and roll up these elements. The last step of mixing, the molecular diffusion expands while these deformations are going on, because the area between the fluid elements is increasing, and also, because the concentration gradients are intensified by the thinning down of the fluid layers.

Turbulent mixing is very complex to simulate because of the diversity of the phenomena involved at different scales. However, its influence upon rate and selectivity of chemical reactions, and also economical requirements gave rise to numerous models of mixers. They are of great importance for they enable optimization procedures including physical and/or geometrical parameters such as viscosity and density of the fluids, or shape and size of the vessel. Such procedures reduce greatly time and cost in scale-up problems.

There are many mixing models, and it is interesting to try to classify them. Patterson (1981) suggests two types of models :

- the first ones, using lagrangian concepts, study the evolution of fluid particles

inside the mixer, the geometry of which is not taken into account (the reactor is treated as a "black box"). The inner fluids are discretized into aggregates or "drops", the courses of which inside the mixer are simulated by D.T.S. or D.A.I. (see for instance Nauman, 1981). The mixer is cut out in different areas, ones considered as perfectly mixed, the others considered as segregated. The different areas (and/or the different aggregates or drops) can exchange matter ones with each others. These exchanges are simulated by different laws of transfer.

- the second ones, using eulerian concepts, are concerned with the variations of mixing quantities (e.g. velocities, concentrations, ...) at fixed points in the mixer. This one is cut out into real volumes upon which the local quantities are calculated by mass and momentum balances taking into account the convection and the diffusion. When the volumes are infinitely small, these balances lead to the classical mass and momentum conservation equations, which have to be solved by finite differences or finite elements techniques.

In this work, the eulerian approach is chosen, because the aim is first of all to understand the flow phenomenon occurring in the device with the help of simulation, and then to use the code to improve the efficiency of the device.

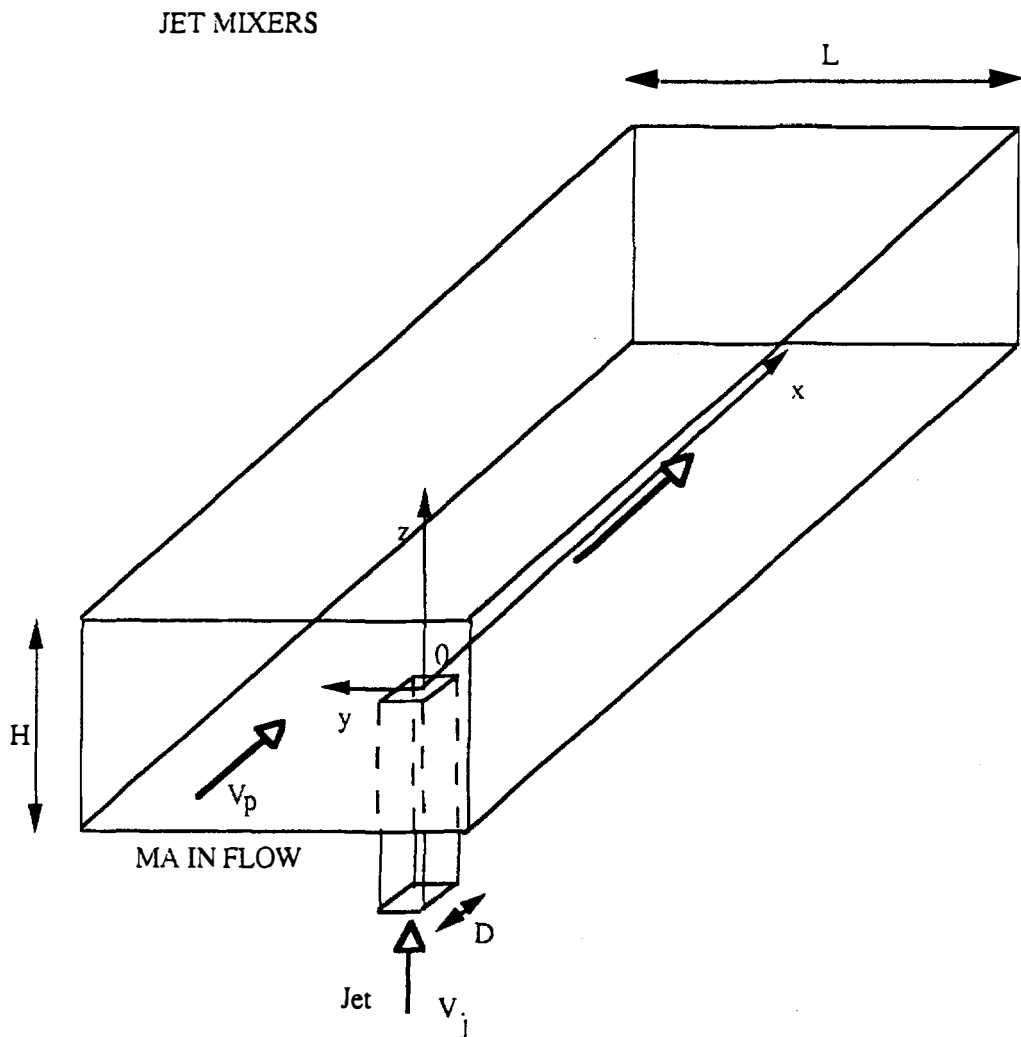

Fig. 1. The tee mixer.

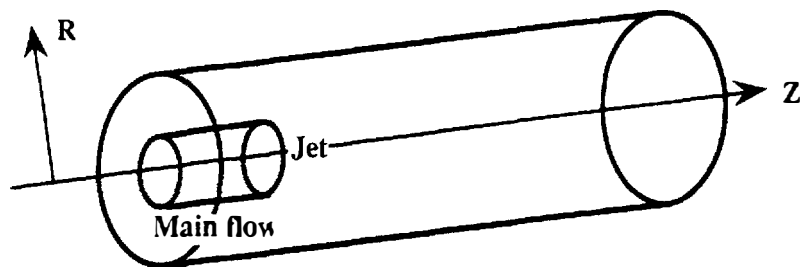

Fig. 2. The axisymmetric mixer.

The results reported here deal with jet-mixers. For a few years, the notion of "jet-mixing" has been seeing increasing application in the chemical process industries as an alternative to the more traditional methods such as stirred tanks, owing to the lower capital costs and bulk than jet-mixers offer. These ones are interesting for in-line mixing in view of their simplicity and efficiency.

Two kinds of geometry are particularly used : tee mixers (Fig.1) and axisymmetric mixers (Fig.2).

THE COMPUTER PROCEDURES

In this contribution, the results of two different computer codes are presented. In both procedures, the k,ϵ two-equations model of turbulence is used to predict the turbulent eddy viscosity variation in the reactor. The transport equations for k and ϵ are solved simultaneously with those of the velocity components and for the pressure. When the velocity field is obtained, the transport equations for the mean concentration and the segregation are solved over the field. The equations solved are well known and can be found in Patterson (1981) for instance.

The first code is a 3D numerical procedure developed in the laboratory to model the mixing in tee mixers. The solution method is a finite-difference procedure in primitive variables (U, V, W, P). The discretisation technique is a control-volume one, largely detailed by Patankar (1980). The computer code, specially written to solve tee-mixer problems, handles a staggered grid in cartesian coordinates, non-uniform spacing, so that grid nodes are grouped in regions where rapid variations are expected. The combined convection-diffusion influence is treated by the Power-Law formulation. The solution of the finite-difference equations set is obtained by the Line by Line method and the interlinkage between the velocity and pressure is handled by the SIMPLER algorithm (Semi Implicit Method for Pressure Linked Equations Revised). A graphic post-processor has been developed based upon the Graphic Kernel System (GKS). It allows 2D representations of the velocity field by arrows and of the scalar fields by isovalues.

The second code is the ESTET one (Lacroix, 1991), developed by EDF (Electricité de France) and SIMULOG. This code is combined with a pre-processing procedure named CEZANNE that can be used to create the mesh and with a post-processing code named PABLO that allows 3D representations of both velocity and scalar fields. Calculations are performed here for the axisymmetric jet mixer.

RESULTS

Tee mixer

This part describes the concentration field generated by a square turbulent jet containing a tracer deflected in a square duct by a main stream normal to the jet axis. The physical situation

considered is shown on Fig.1 : V_j and V_p refer respectively to the side stream and main stream velocity. The computations are performed for the rectangular box-shaped domain around the jet. As the side stream enters the main stream exactly at the center, the flow field is symmetrical about the plane $y=0$ passing through the central plane of the jet . The Reynolds number of the flow is 27300. The diameter ratio between the jet and the main channel is 0.2. One of the main parameters of the mixing phenomenon in this case is the velocity ratio between the jet and the main flow.

Two different situations may occur if the jet impinge the opposite wall or not, and the effect on mixing is very important. Fig. 3. and Fig. 4. shows iso-values of concentration on a plane near the symmetry plane of the mixer, in the cases of inlet velocity ratio of 1 and 5 respectively.

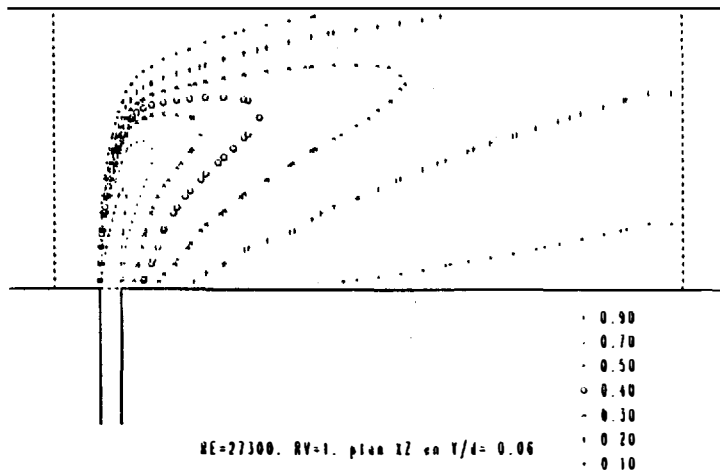

Fig. 3. Iso values of concentration on the symmetry plane of the tee-mixer in non impinging conditions.

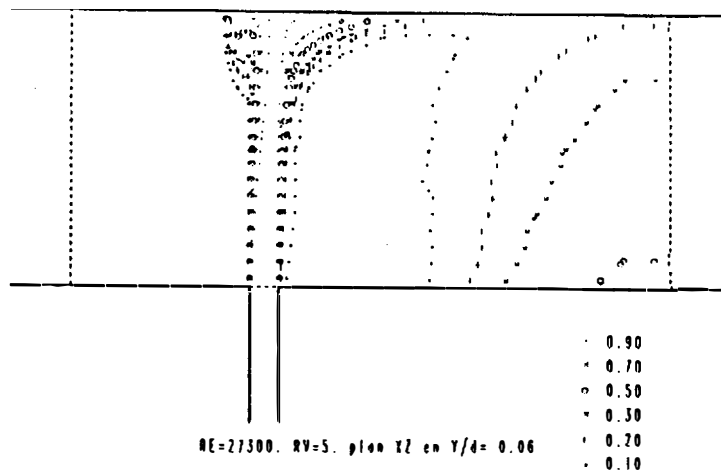

Fig. 4. Iso values of concentration on the symmetry plane of the tee-mixer in impinging conditions.

On the first figure, the jet is not impinging on the opposite wall, it is thus deflected by the main stream. Mixing occurs in the high turbulent flow field created by the jet. On Fig.4, the jet is not deflected by the main stream. It creates a thin layer at high concentration near the opposite wall and the mixing seems to be more difficult. A dead zone with a very low concentration can be observed just past the jet.

Fig. 5. and Fig. 6. show also iso - values of concentration in an orthogonal section of the main square duct, at a similar distance from the exit of the jet (4.50 and 4.92 diameter of the jet respectively), in the case of not-impinging and impinging jet respectively.

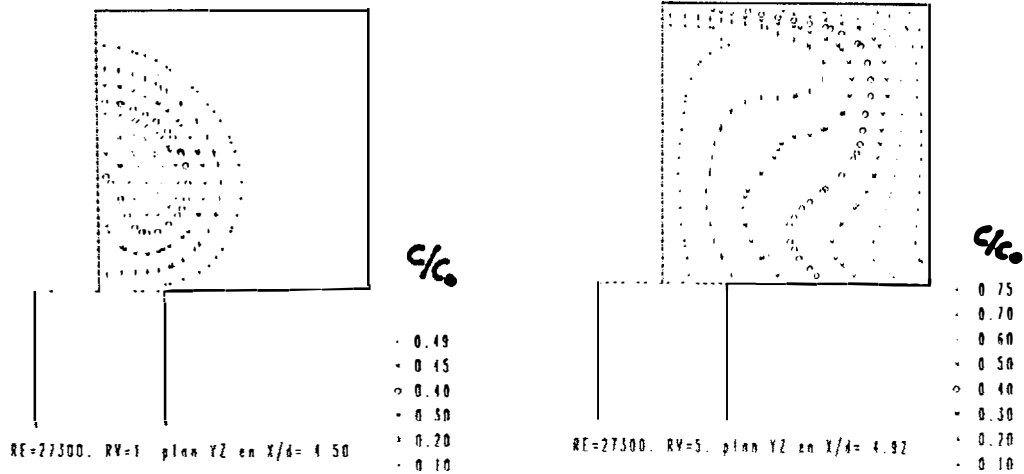

Fig. 5. Iso - values of concentration on a section of the tee-mixer in non-impinging conditions.

Fig. 6. Iso - values of concentration on a section of the tee-mixer in impinging conditions.

Also on these two figures, the differences between the two mixing regimes can be well observed. In the first case, the highest concentration is near the symmetry plane of the duct. The lateral part of the duct is not concerned by mixing, the concentration is very low in this area. On the contrary, in the second case, the higher concentration is near the lateral wall and the lower on the symmetry plane of the duct.

Axisymmetrical jet mixer

This part describes the concentration field generated by an axisymmetrical jet containing the tracer issuing in a tubular channel with a parallel main flow without tracer. The physical situation considered is shown on Fig. 2. The computations are performed for one plane because of the axisymmetry of the flow. The Reynolds number of the jet is 40000. The velocity ratio between the jet and the main flow is 17.4. The diameter ratio is 0.2.

Fig. 7. shows the isovalues of the concentration in the first part of the mixer. Mixing is performed in this case by the turbulence generated by the high velocity gradients between the jet and the main flow.

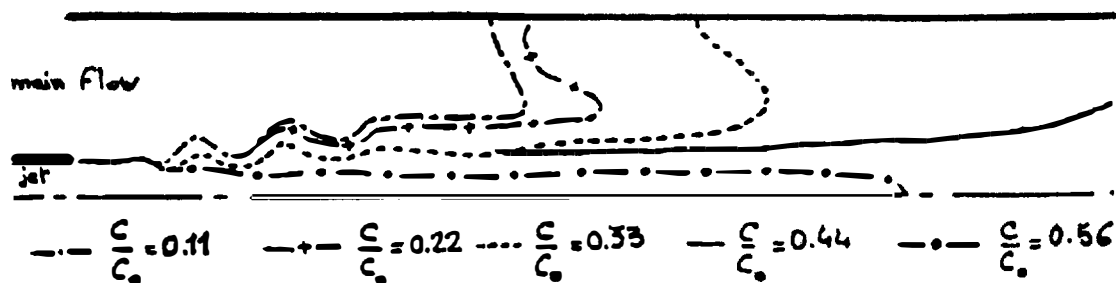

Fig. 7. Iso - values of concentration in the axisymmetric jet-mixer.

CONCLUSIONS

With these basic examples, the usefulness of simulation of complex fluid flows to investigate mixing is obvious. The development of such codes is very long and difficult, but after this phase, it is easy to investigate the influence of any parameter of the system, thus to try to optimize mixing. However, the codes give a great amount of data: three velocity components, pressure, kinetic energy of turbulence, dissipation rate, mean concentration and segregation at each calculated point of the 3D domain. All these raw informations are impossible to be used, that is why a post-processor is necessary to quickly present the results of the simulation. Of course, black and white 2D figures (such as Fig.3. to Fig.7.) are quite poor in comparison with high resolution colour 3D figures that can be obtained now on computer screens with post processors like PABLO for instance.

REFERENCES

- Lacroix, C. (1991). Development and use of a computational fluid dynamics code for aeronautical analysis. Journées Convex, Technology trends in aerospace, Octobre 1991, Toulouse, France.
- Nauman, E., B. (1981). Residence time distribution and micromixing. *Chem. Eng. Comm.*, 8, 53-131.
- Patankar, S., V. (1980). *Numerical heat transfer and fluid flow*. Hemisphere Publishing Company, Washington.
- Patterson, G., K. (1980). Application of turbulence fundamentals to reactor modelling and scale-up. *Chem. Eng. Comm.*, 8, 25-52.