



HAL
open science

Bronze objects for Atlantic Elites in France (13th-8th century BC)

Pierre-Yves Milcent

► **To cite this version:**

Pierre-Yves Milcent. Bronze objects for Atlantic Elites in France (13th-8th century BC). Hunter Fraser; Ralston Ian. Scotland in Later Prehistoric Europe, Society of Antiquaries of Scotland, pp.19-46, 2015, 978-1-90833-206-6. <hal-01979057>

HAL Id: hal-01979057

<https://hal.science/hal-01979057v1>

Submitted on 12 Jan 2019

HAL is a multi-disciplinary open access archive for the deposit and dissemination of scientific research documents, whether they are published or not. The documents may come from teaching and research institutions in France or abroad, or from public or private research centers.

L'archive ouverte pluridisciplinaire **HAL**, est destinée au dépôt et à la diffusion de documents scientifiques de niveau recherche, publiés ou non, émanant des établissements d'enseignement et de recherche français ou étrangers, des laboratoires publics ou privés.



HAL Authorization

Scotland in Later Prehistoric Europe

Edited by

FRASER HUNTER and IAN RALSTON



Jacket photography by Neil Mclean; © Trustees of National Museums Scotland

Published in 2015 in Great Britain by the Society of Antiquaries of Scotland

Society of Antiquaries of Scotland
National Museum of Scotland
Chambers Street
Edinburgh EH1 1JF
Tel: 0131 247 4115
Fax: 0131 247 4163
Email: administration@socantscot.org
Website: www.socantscot.org

The Society of Antiquaries of Scotland is a registered Scottish charity No SC010440.

ISBN 978 1 90833 206 6

British Library Cataloguing-in-Publication Data

A catalogue record for this book is available from the British Library.

Copyright © contributors 2015

All rights reserved.

The authors and the Society of Antiquaries of Scotland gratefully acknowledge funding towards the publication of this volume from the Marc Fitch Fund, the Robert Kiln Trust and National Museums Scotland.



Design and production by Lawrie Law and Alison Rae
Typesetting by Waverley Typesetters, Warham, Norfolk
Manufactured in Spain

Contents

<i>Acknowledgements</i>	vii
<i>List of contributors</i>	ix
<i>List of illustrations</i>	xi
1 Introduction <i>Fraser Hunter</i>	1
2 Facing the Northern Ocean: the British Late Bronze and Iron Ages in their continental perspective <i>Barry Cunliffe</i>	5
3 Bronze objects for Atlantic elites in France and beyond (thirteenth–eighth century BC) <i>Pierre-Yves Milcent</i>	19
4 The Later Bronze Age and Early Iron Age in the southern Low Countries: where East meets West <i>Eugène Warmenbol</i>	47
5 Changes in iconography, votive practices and burial rites at 500 BC in southern Scandinavia <i>Flemming Kaul</i>	85
6 ‘I have not been able to discover anything of interest in the peat’: landscapes and environments in the Later Bronze and Iron Ages in Scotland <i>Richard Tipping</i>	103
7 Keeping up with the neighbours? Changing perceptions of later prehistoric societies in central Britain <i>Colin Haselgrove</i>	119
8 The contribution of contract archaeology to Iron Age research in Scotland <i>Andrew Dunwell</i>	139
9 Bronze Age architectural traditions: dates and landscapes <i>Rachel Pope</i>	159
10 Within these walls: household and society in Iron Age Scotland and Ireland <i>Ian Armit</i>	185
11 The hillforts and enclosed settlements of Scotland: an overview <i>Ian Ralston</i>	201
12 Belief and ritual(isation) in later prehistoric Scotland <i>Martin Goldberg</i>	211

13	Craft in context: artefact production in later prehistoric Scotland <i>Fraser Hunter</i>	225
14	It's pretty, but is it Celtic art? North British decorative metalwork in its European context <i>J V S Megaw & M Ruth Megaw</i>	247
15	Scotland in Europe <i>Stratford P Halliday</i>	281
	<i>Index</i>	295

Acknowledgements

The papers in this volume were delivered at a conference held by the Society in Edinburgh on 19–21 September 2008. The conference was organised by a sub-committee of the Society's Research Committee, chaired by its convenor, the late Ian Shepherd, and comprising Dr David Clarke, Dr Simon Gilmour, Dr Fraser Hunter, Dr Brendan O'Connor and Professor Ian Ralston. For tremendous assistance in the practical aspects of organising what was a memorable and well-attended conference, thanks are due to the Society's Director, Dr Simon Gilmour, and its staff, especially Jacqui Clabby and Jan Paterson.

The editors were invited to take the proceedings of the conference forward for publication – a process which has proved more protracted than we intended owing to pressures of other work, but we feel the resulting papers are worth the wait. The conference was supported by Aberdeenshire Council, Historic Scotland, National Galleries of Scotland, National Museums Scotland, RCAHMS and the University of Glasgow. The publication has been grant-aided by the Marc Fitch Fund, Robert Kiln Trust and National Museums Scotland.

List of contributors

IAN ARMIT
University of Bradford

BARRY CUNLIFFE
University of Oxford

ANDREW DUNWELL
CFA Archaeology, Musselburgh

MARTIN GOLDBERG
National Museum of Scotland, Edinburgh

STRATFORD P HALLIDAY
University of Edinburgh

COLIN HASELGROVE
University of Leicester

FRASER HUNTER
National Museum of Scotland, Edinburgh

FLEMMING KAUL
National Museum of Denmark, Copenhagen

J V S MEGAW and M RUTH MEGAW †
Flinders University, Adelaide

PIERRE-YVES MILCENT
Université de Toulouse 2

RACHEL POPE
University of Liverpool

IAN RALSTON
University of Edinburgh

RICHARD TIPPING
University of Stirling

EUGÈNE WARMENBOL
Université Libre de Bruxelles

CHAPTER 3

Bronze objects for Atlantic elites in France and beyond (thirteenth to eighth century BC)

PIERRE-YVES MILCENT

This paper is a first attempt to re-examine synthetically the Late Bronze Age (LBA) and Early Iron Age (EIA) in Atlantic France. It owes a large tribute to previous studies, especially those of British and German scholars such as Colin Burgess, Brendan O'Connor, Stuart Needham, Sabine Gerloff and Albrecht Jockenhövel. The objective is to study the Atlantic cultural complex in France through the metallic material culture of the elites. Indeed, these metallic objects, the craftsmen who made them, the traders who spread them and the elite who owned and used them are still the main source for identification of the LBA Atlantic complex.

The subject of this article is Atlantic France, which could be seen as too far away for a conference about Scotland. However, western and northern France played a pivotal role in the large-scale elite Atlantic networks during the LBA, and Britain was open to the objects, ideas and people coming from continental Europe. Thus, the working, organisation and evolution of the Atlantic elite in France have many things to do with the history of elites in northern Britain. Secondly, Atlantic France is important not only for the numerous bronze finds (around 20,000 fragments or objects are known), but for their variety. Indeed, it has long been observed that the distribution of objects in the Atlantic regions is not uniform. Archaeological visibility mostly depends on regional hoarding customs. A good example is given by bronze defensive weapons during the LBA: bronze shields are well represented in Britain and Ireland, but none has been found in Atlantic France (illus 3.1). Helmets show an opposite situation: many come from northern France, but no fragment that I can verify comes from Great Britain or Ireland.¹ The making of a shield and a helmet both require similar bronze sheet-working technologies and we could assume that most LBA elite warriors wore similar panoplies on both sides of the Channel. The richest panoplies should include a bronze helmet,

a shield and possibly a bronze cuirass and greaves, although such cuirasses and greaves are unknown in Atlantic Europe apart from a few examples in France and Belgium (Clausing 2002, 158–9).

Another example of the advantages from working at a large scale when considering LBA elites is the distribution of cauldrons and buckets (illus 3.2). In Ireland, northern and western Britain, vessels were found mostly complete because the majority were put in bogs, lakes and rivers. They have also been found in south-eastern England, Atlantic France and western Iberia but there, without exceptions, only fragments survived in dry-land hoards (Gerloff 2004, 128). Before hoarding, the cauldrons and buckets were destroyed and reduced to little pieces of sheet. Therefore, in Atlantic France, the recognition of these kinds of large objects is more difficult than elsewhere. For this reason, some archaeologists thought the Atlantic cauldrons were produced and probably invented in Ireland (Coffyn 1985, 57). However, a new find in Brittany, at Saint-Igeaux (Fily 2004), highlights a prototype class A cauldron dating to the beginning of the LBA (around the thirteenth century BC) and suggests that Atlantic cauldrons were in use very early on the continent, before the Irish series (Gerloff 2004, 126).

In sum, we should be very careful with the interpretation of distribution maps: clusters only show the regions where LBA and EIA customs and behaviour make the archaeological remains visible. They are not necessarily regions of invention, production, or great consumption for bronzes. New finds like the cauldron of Saint-Igeaux will probably modify again our view of the beginnings of Atlantic LBA elite material culture. In other words, with this problem of archaeological visibility/invisibility, this elite material culture is an international puzzle, and we should always look at different regions to complete the range of data and understand what happened. Therefore Atlantic France

SCOTLAND IN LATER PREHISTORIC EUROPE

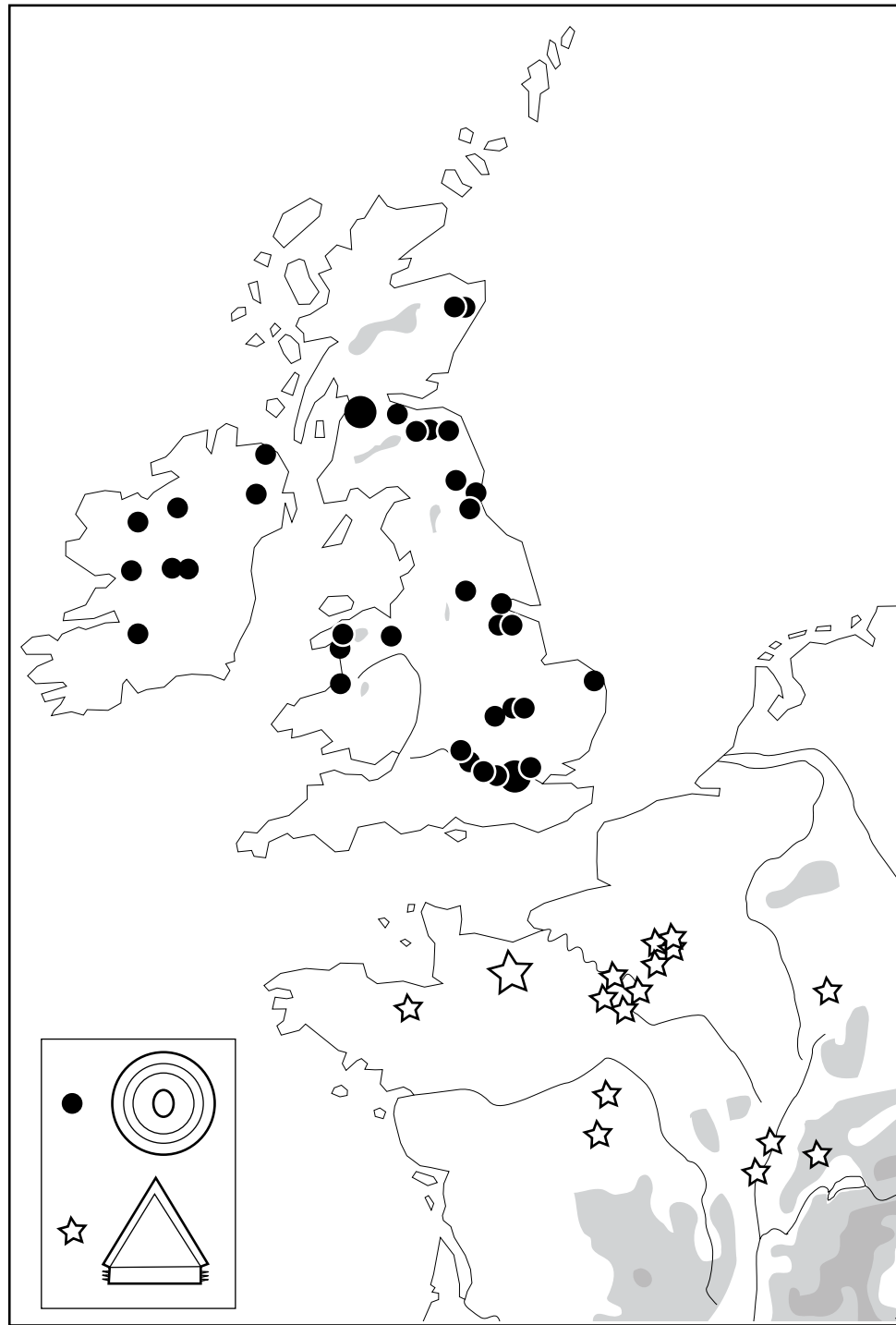

Illustration 3.1

Late Bronze Age bronze shields and crested helmets in the British Isles and Atlantic France (after Schauer 2003, fig 5.2 and Coffyn 1985, map 27, with additions and corrections)

BRONZE OBJECTS FOR ATLANTIC ELITES IN FRANCE AND BEYOND

is an interesting way to further the understanding of the Scottish LBA and EIA.

After these preliminary remarks, we will first pay attention to the concept of the Atlantic Bronze Age in France, and, more precisely, to the question of the definition and chronology of elite equipment. It will be necessary afterwards to look at the available documentation and to give an idea of the number of objects known, their contexts and location of discoveries; the aim is to have a better idea of cycles of hoarding. Next, we will propose a brief history of elite gear in Atlantic France. In conclusion, we would like to give an overview of the Atlantic LBA and the beginnings of the EIA in a broader perspective.

Atlantic LBA and EIA from France

I would like first to examine an essential point: the concept of the Atlantic Bronze and Iron Age in French studies. In fact, there are several different ways to define or to consider this concept and it is impossible to give a precise definition of this notion in time and space (illus 3.3).

In France, the idea appears slowly at the beginning of the twentieth century. Abbé Henri Breuil (1900) and Joseph Déchelette (1910, chapter 1) were conscious of the close connections between north-western France and the British Isles during the LBA. Abbé Breuil saw south-eastern England and the northern Paris Basin as the same metalworking province which he called '*province britanno-séquanienne*'. But Pierre-Roland Giot and above all Jacques Briard, two Bretons who knew British studies well, were the first in France to share the recognition of an Atlantic LBA (Giot 1963; Briard 1965). Since the end of the 1980s, there has been a revival of work on the French Atlantic LBA, particularly in Picardy and Normandy, and not only due to rescue excavations. Sadly, many results are still unpublished or little known abroad.

Today, especially due to the works of André Coffyn (1985), many French archaeologists think that the Atlantic Bronze Age began with the end of the Chalcolithic and spread in France from the Pyrenees to Belgium. In this point of view, Atlantic France is supposed to belong to a large western cultural complex including the British Isles, a part of Benelux, and during the LBA (or before, for some scholars) northern and western Iberia. The definition

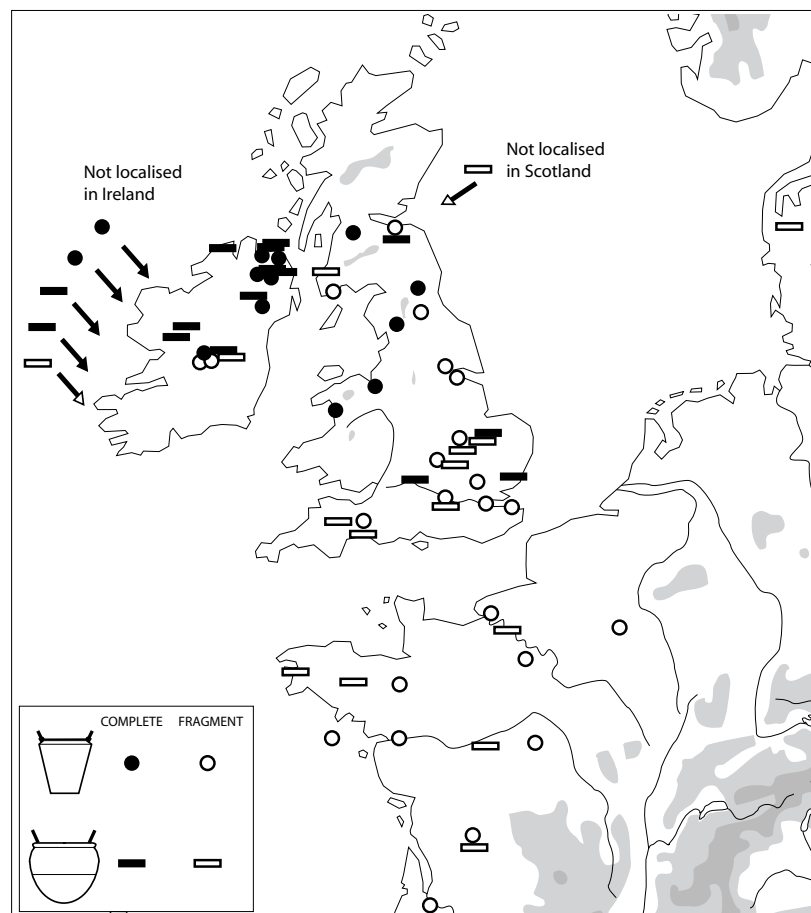
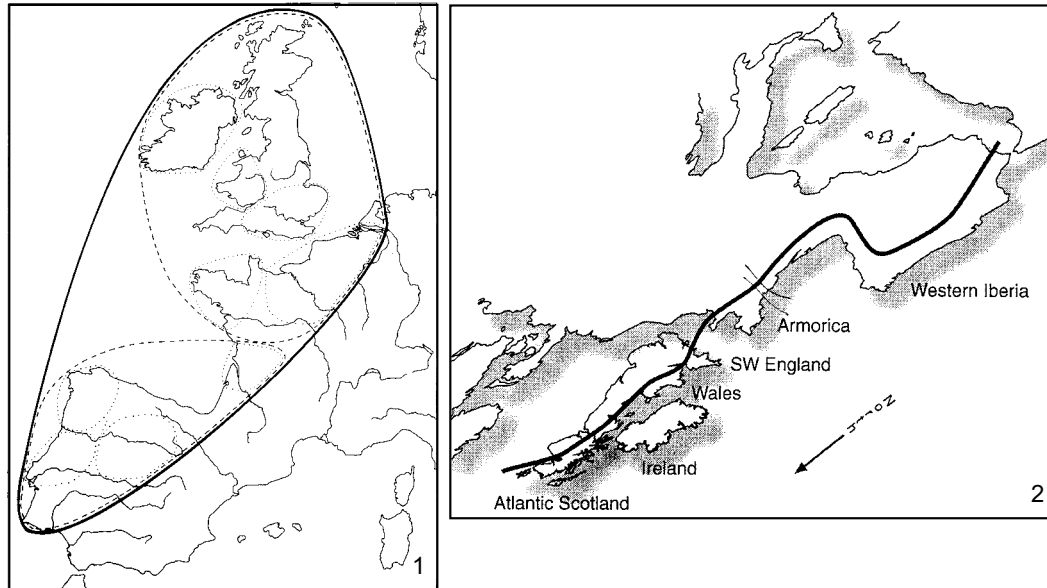

Illustration 3.2

Distribution of Late Bronze Age buckets and cauldrons in the British Isles and Atlantic France according to the mode of deposition (from Gerloff 1986 and 2004, with additions for France)

is mostly based upon the distribution of certain bronze artefacts and the absence of north Alpine features such as cremations deposited in urns or richly decorated pottery in settlements during the LBA. Recent works point to the existence of some roundhouses in northern France (Dechezleprêtre & Ginoux 2005; Milcent forthcoming), but it is not yet clear if this

SCOTLAND IN LATER PREHISTORIC EUROPE



Rising Sun

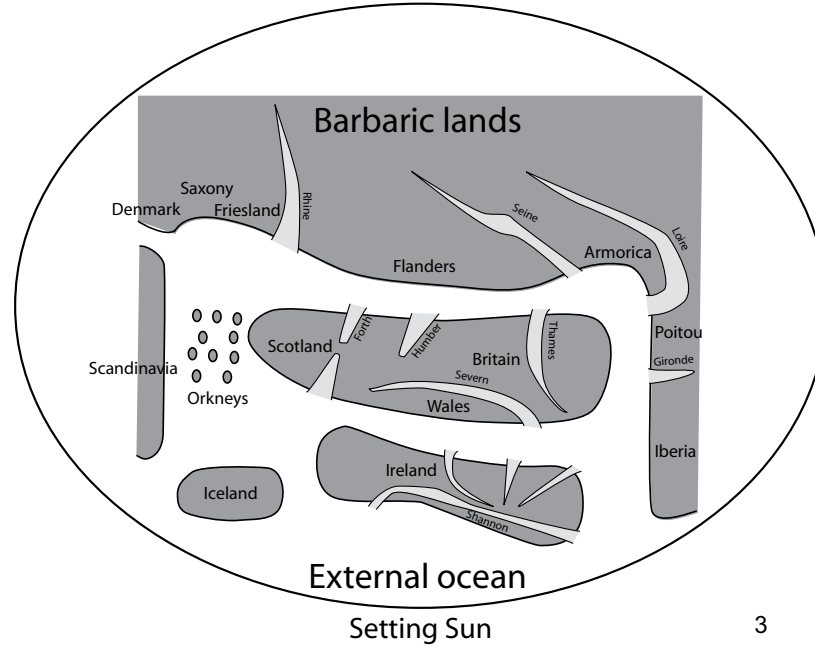

3

Illustration 3.3

Examples of maps showing different visions of the Atlantic Bronze Age and Iron Age. 1 Atlantic complex during LBA 3 according to Brun (1991, fig 4); 2 Atlantic Europe in the Iron Age according to Henderson (2007, fig 1.1); 3 conjectural reconstruction of the vision of western Europe by the local people during protohistory (inspired by the map given by Giraldu Cambresis in the *Topographia Hibernae* at the end of the twelfth century AD)

BRONZE OBJECTS FOR ATLANTIC ELITES IN FRANCE AND BEYOND

kind of architecture is common or not. Furthermore, Atlantic France is supposed to end with the EIA and the numerous hoards which contain Armorican axes. In fact, there is no synthetic work about northern and western France during the EIA and these

regions are seen as a peripheral western border of the Hallstatt and Early La Tène cultures, with very few exceptions.

My conception is a bit different for several reasons.

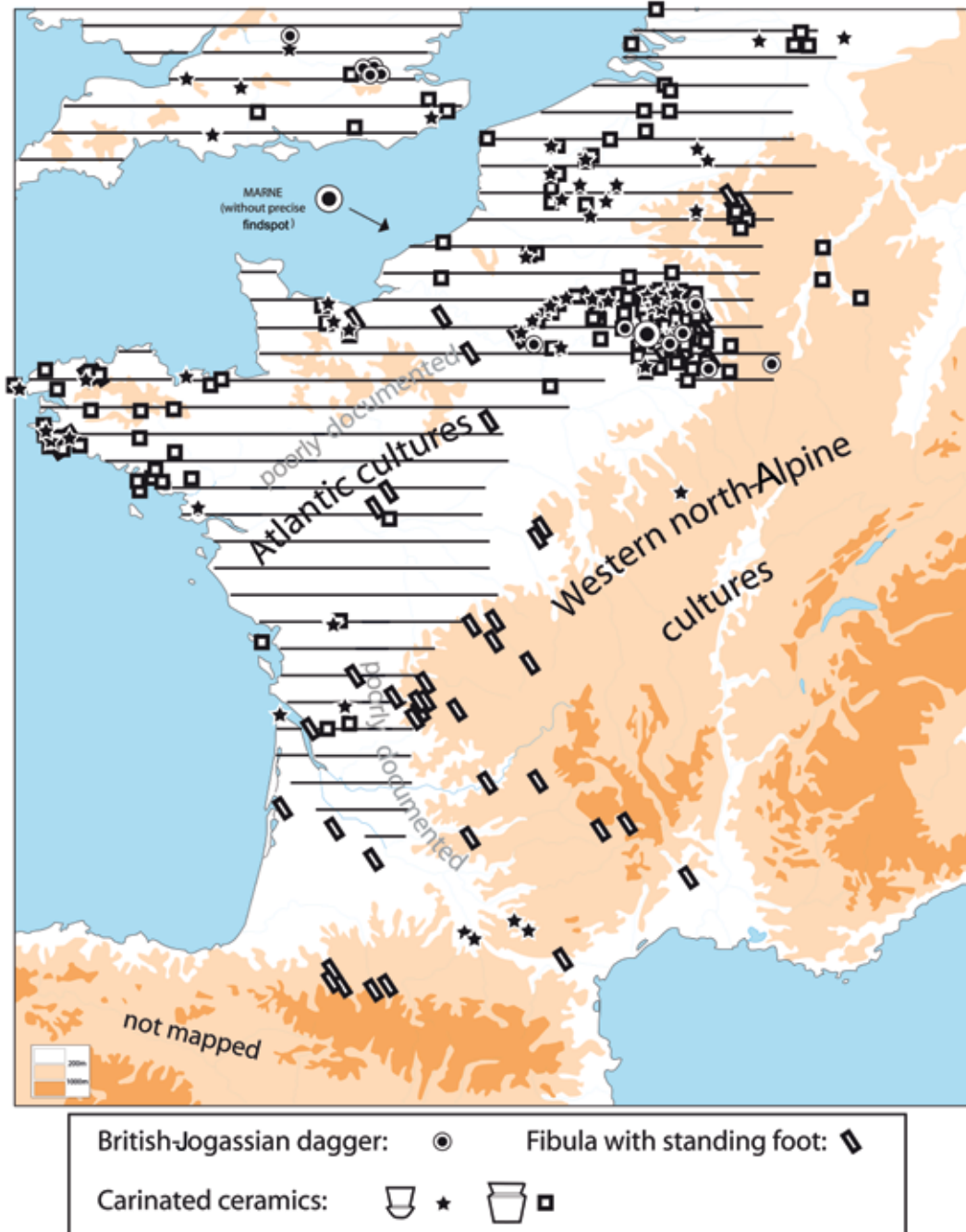

Illustration 3.4

Western objects and the extent of northern Atlantic cultures in France at the end of the Early Iron Age (525–425 BC) (Milcent 2006, fig 4, 10)

SCOTLAND IN LATER PREHISTORIC EUROPE

- Most of Aquitaine (the zone south of Gironde and the lower Garonne) could not be seen certainly as a part of the Atlantic cultural complex because few bronzes come from there and there are no recognised LBA hoards. Settlements or pottery are also very poorly known. Therefore, the cultural features of this region are not clear for the Bronze Age.
- Links between western France and Iberia are restricted essentially to Aquitaine until the LBA; the huge Atlantic cultural complex deals only with the end of the Bronze Age (LBA 2 and 3).²
- I support the existence of an Atlantic EIA in France; for example, I would include Champagne in Atlantic France and see it as an Atlantic culture influenced by western Hallstatt cultures (Milcent 2006). The spatial extent of Atlantic France during the EIA does not differ very much compared with its LBA extent (illus 3.4). In contrast to the vision defended recently by some British scholars (Henderson 2007), there is no decisive argument for limiting the Atlantic EIA to western Brittany and the western British Isles. This point of view has important consequences for understanding the beginning of La Tène cultures and the substantial contribution of Atlantic cultures to this process (Milcent 2006; 2009; forthcoming).
- Finally, the identification of the Atlantic LBA and EIA is correct only if we consider the distribution of certain specific metallic objects (such as cauldrons or flesh-hooks), most belonging exclusively to or exchanged by an elite. From western Andalusia to Scotland, apart from elite gear and eventually some fortified settlements, the material culture shows no real unity: for example, ceramics and decorative patterns, forms of houses and funeral practices were often different, even within Atlantic France. In France, from west to east, the transition from one group of ceramics to another is gradual and there is no true limit between the Atlantic and north Alpine areas from this point of view. We could also highlight the case of ceramics which were made in the Atlantic region from the Venat hoard in Charente: most of these ceramics and their decoration are very similar to the

products coming from the Bourget Lake in the French Alps (Kerouanton 2002). Apart from elite material culture, it is quite impossible to see clear distinctions between north Alpine and Atlantic France: a large band of territories with mixed cultural features can be identified which show some geographical variation in each period.

In other words, what we identify as a cultural complex is rather the materialisation of a strong network linking an elite who exchanged raw materials (such as copper, tin, gold, amber and salt) and metallic objects, often prestigious; an elite who shared more or less the same cosmology, heroic values and behaviour, and probably spoke linked (Celtic?) dialects. Craftsmen, slaves, warriors and adventurers, members of the elite themselves, contributed to the circulation of goods and shared identities in common. All these circulations inside the elite network had an impact on the rest of material culture. This could explain common features across long distances observed in some provinces of the Atlantic complex. However, many imports from other cultural complexes show important interconnections with the rest of Europe, and we could not consider the Atlantic LBA and EIA in terms of true cultural unity. The Atlantic elite groups forged or reinforced a shared identity, not with an ethnic sense, but rather with ethical, social, political and economic dimensions, in a manner which could be compared more or less with the Mediterranean aristocrats during the archaic period who shared many heroic values, a similar system of exchange and the same orientalising prestige goods.

Elite gear and chronology

Before presenting the data, we should briefly go into two important points: the list of objects which were probably under elite control, and the Atlantic chronology of the LBA and beginning of the EIA.

Concerning Atlantic elite gear, the objects most cited among archaeological publications (illus 3.5) are:

- large golden jewellery;
- defensive weapons such as shields and helmets;
- cauldrons and buckets;
- other feasting gear, notably flesh-hooks and rotary spits.

I do not mention offensive weapons such as spears and swords because in the full LBA these weapons

BRONZE OBJECTS FOR ATLANTIC ELITES IN FRANCE AND BEYOND

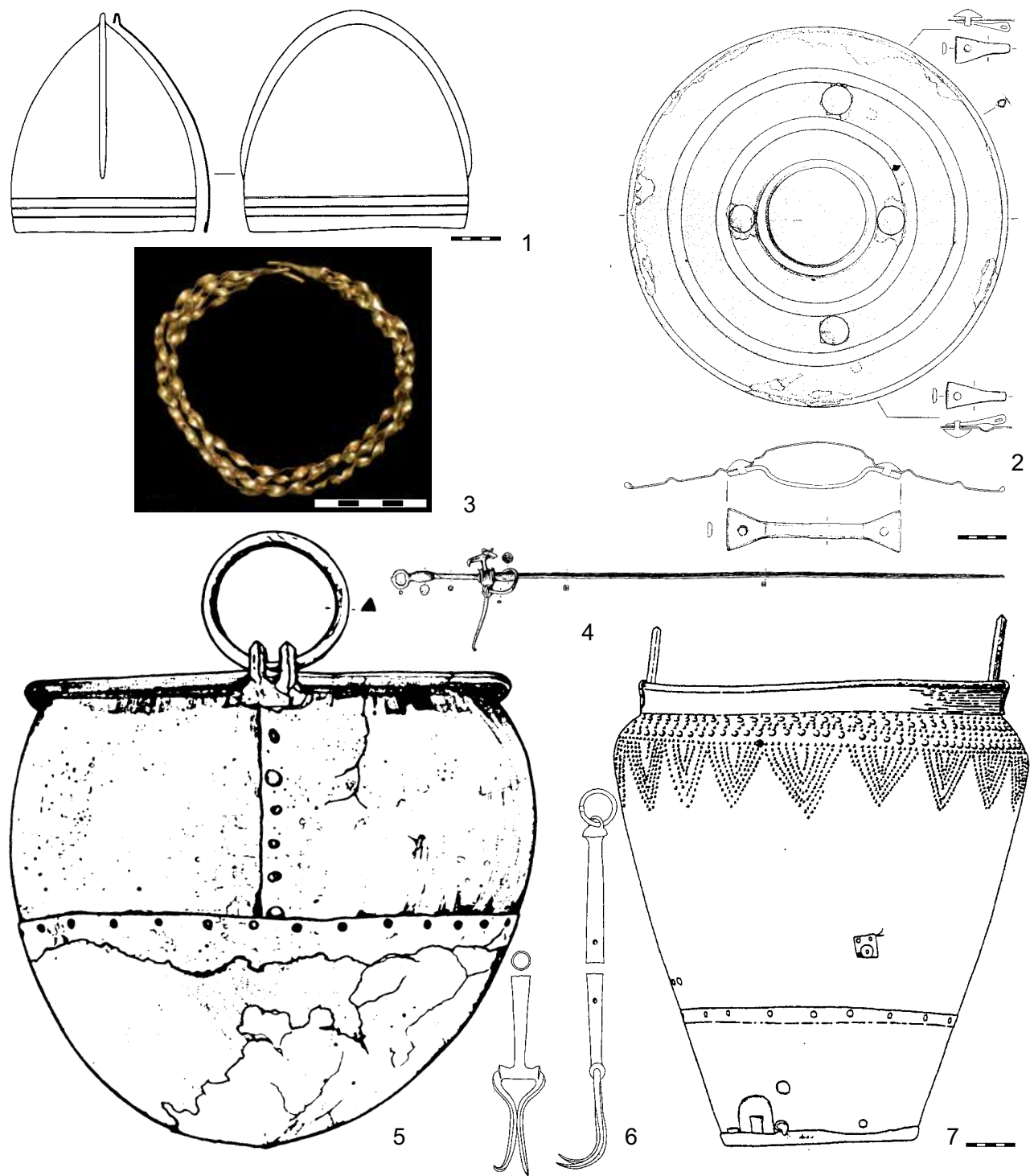

Illustration 3.5

Conventional Atlantic elite gear during the Late Bronze Age (swords are excluded). 1 helmet from Mantes-la-Jolie (Yvelines) (after Mohen 1977, fig 503); 2 shield from Long Wittenham (Oxfordshire) (Needham 1979, fig 2); 3 gold twisted bracelet from near Quimper (Finistère) (courtesy Musée Dobrée, Nantes); 4 rotary spit from Port-Sainte-Foy (Dordogne) (Chevillot 1989, pl 324); 5 cauldron from Colchester (Essex) (Gerloff 1986, fig 6 i); 6 flesh-hook from Inveraray Estates (Coles 1960, fig 3); 7 bucket from Cape Castle (Co Antrim) (Gerloff 2004, fig 17.3 no 4)

SCOTLAND IN LATER PREHISTORIC EUROPE

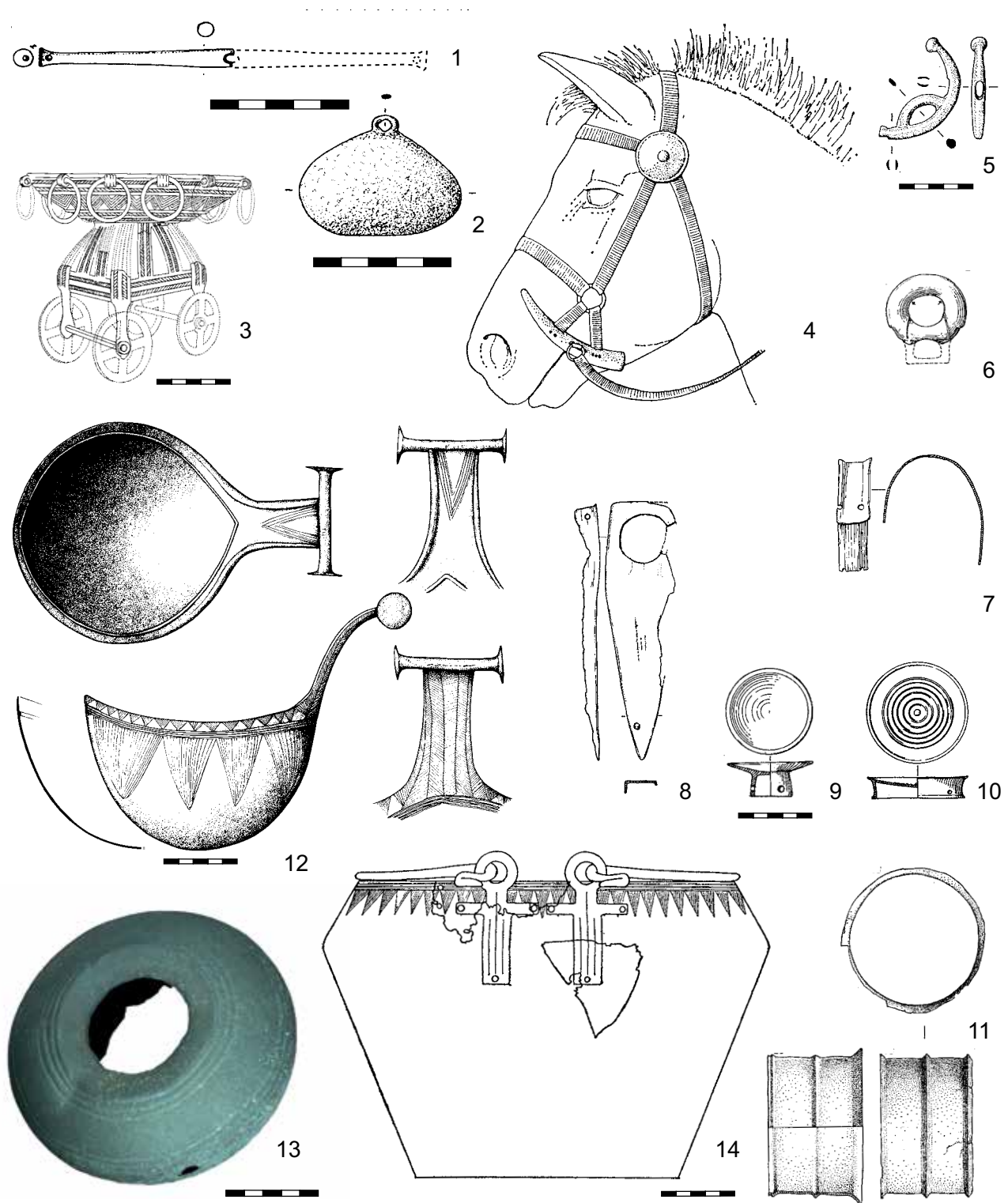

Illustration 3.6

Other Atlantic elite gear during the Late Bronze Age. 1 scale-beam from Sorel-Moussel (Eure-et-Loir) (Bailloud & Mohen 1987, pl 85 no 8); 2 weight from Saint-Léonard-des-Bois (Sarthe) (Charnier et al 1999, fig 5 no 35); 3 miniature wagon from Baiões (Silva 1986, pl 96); 4 conjectural reconstruction of bridle with antler cheek pieces (Britnell 1976, fig 3A); 5 cheekpiece from Isleham (Cambridgeshire) (Britnell 1976, fig 3B); 6–10 harness fitting and wagon fittings from Horsehope Craig (Peeblesshire) (Piggott 1955, fig 2 no 15, fig 1 nos 2, 3, 8, 7); 11 wagon naves from Heathery Burn Cave (Durham) (Britton & Longworth 1968, pl 10(3) nos 56–7); 12 ladle from Corrymuckloch (Perthshire) (Cowie et al 1996, ill 4); 13 musical instrument from Avranches (Manche); 14 Central European cauldron from Adabrock (Isle of Lewis) (Coles 1960, fig 5)

BRONZE OBJECTS FOR ATLANTIC ELITES IN FRANCE AND BEYOND

were probably not an elite preserve since they are too numerous: we know of thousands from Atlantic France, compared with the dozens of true prestige goods cited above. Swords, for example, were frequent enough during LBA 3 to be the focus of a huge recycling operation, particularly to produce hog-back knives (Boutouille & Milcent 2006). Nevertheless, offensive weapons provide good clues for the influences received or created by the Atlantic elite (Milcent 2012).

For Atlantic France, this elite gear inventory should be completed (illus 3.6) with:

- precision weights and beams from scales;
- model wagons;
- horse gear;
- wagon fittings;
- musical instruments;
- exotica.

Exotica are a more speculative category of elite goods because, unlike the other bronze objects, their value comes primarily from their distant origin and not necessarily from an expensive or rare material, or an exceptional quality of fabrication. For example, some very simple British axes could possibly be seen as valuable exotica in France.

With the circulation of objects and standardisation of production over long distances in elite networks, these elite goods give great opportunities to establish a precise chronology, sometimes with a stage resolution of around a century. This is a unique opportunity if we consider the difficulties in dating many settlements of the same period, and we could expect an even better resolution in the future.

Chronological systems between France and the British Isles can be linked in outline, but it becomes more difficult when we consider the details of absolute chronology. In France, the chronological system derives from Briard's chronology (1965, 299), with three main stages during the LBA and another one for the beginning of the EIA. Over the last twenty years, new research upon regions outside Atlantic France has given opportunities to modify the chronological system. First, new chronological and typological horizons were identified: for example, ten years ago, following Christopher Pare (1991; 1998; 1999), we proposed a new typology, chronology and origin for the so-called 'Hallstatt swords' and their chapes (Milcent 1998; 2004, 78–113);³ Ian Colquhoun and Stuart

Needham, brought to light a transitional metalwork assemblage in southern Britain called Blackmoor (Colquhoun 1979; Needham 1996; Needham et al 1997); while Dirk Brandherm and Colin Burgess have recently clarified the typology and chronology of the carp's-tongue sword family (Brandherm 2007; Brandherm & Burgess 2008). With Sabine Gerloff (1981; 2007) and Brendan O'Connor (1980; 2007), these authors brought to light many elements that clarify the British and French chronological sequence. It is possible therefore to propose a new and more detailed relative chronology (illus 3.7; Milcent 2012). Secondly, the absolute chronology of the metalwork assemblages have become more precise – in Britain through a targeted programme of radiocarbon dating (Needham et al 1997), in south Germany and the Swiss lakes region with the support of cross-dating and dendrochronology. Given the position of France, it is possible to correlate the French Atlantic sequence to the British and north Alpine relative chronologies (illus 3.7), but some problems remain in the details, such as the correlation of the Blackmoor stage. In fact, the biggest problem concerns absolute chronology, which is fixed in regions outside Atlantic France: the compatibility between British and German-Swiss absolute chronologies is problematic for the early and full LBA. This question highlights the need for establishing an independent absolute chronology in Atlantic France.

The recognition of the Blackmoor stage, dated roughly of the end of eleventh century and first half of the tenth century BC as we will see, is particularly relevant for understanding the synchronisation problems of the different chronological systems.

Contexts of discoveries and evolution of hoarding

There are, as in the British Isles and Iberia, very few tombs with elite gear in Atlantic France. We could mention only some cremation burials with gold rings from LBA 2 (Toupet 1983; Billand & Talon 2007) and cremations with horse gear in EIA 1 such as Saulces-Champenoises (Ardennes) (Flouest & Stead 1981). Settlements often produce metallic objects, but generally in small quantities and very few of them yield elite goods apart from some hillforts such as Fort Harrouard in Eure-et-Loir (Bailloud & Mohen 1987) or the fortified sites in the lower Oise basin (Blanchet 1984, 353–8). In fact, many elite objects are isolated finds, often from dredging in rivers, and it is often a

SCOTLAND IN LATER PREHISTORIC EUROPE

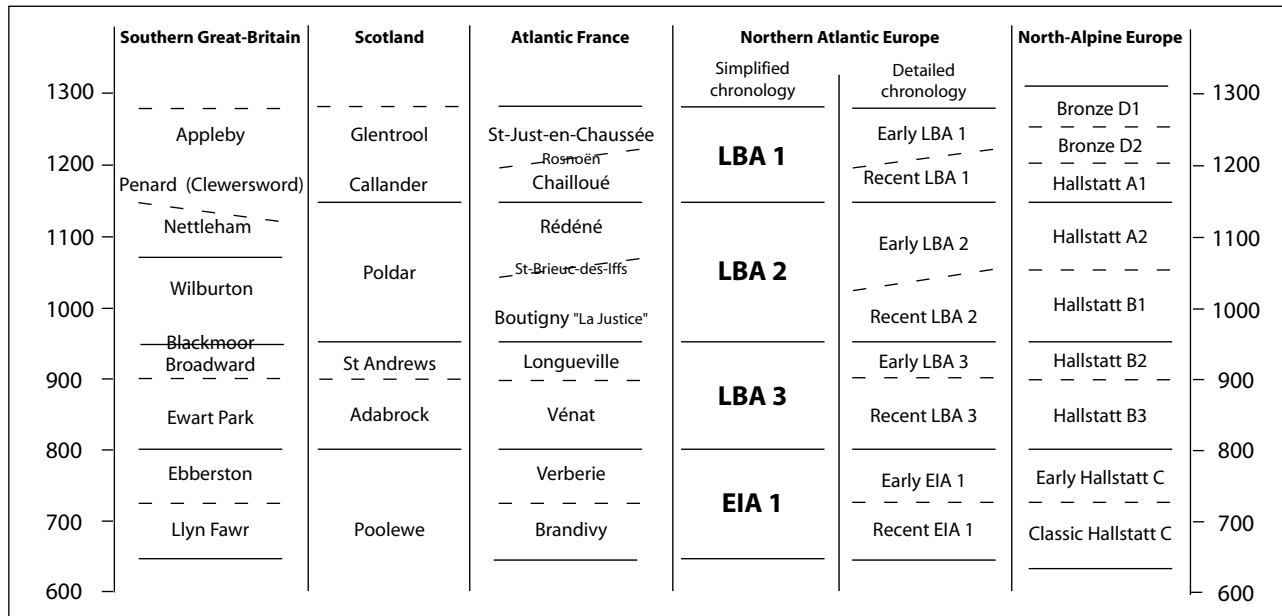

Illustration 3.7

The metalworking assemblage chronology of the Late Bronze Age and the beginning of the Early Iron Age from west to east (after Brandherm 2007, 9–20; Coles 1960; David-Elbiali 2000; Needham et al 1997; Milcent 2010)

problem to date them with precision. However, the majority of elite objects belong to hoards coming from dry and wet land. It is very important therefore to have a precise view of the phenomenon of hoarding in Atlantic France.

At present, 342 LBA and earliest Iron Age⁴ hoards are known, with at least 18,587 bronze fragments or objects, many lost and not or poorly described. Only 10,800 of the bronzes have been published. It is important to note the different distributions of objects and hoards in time and space (illus 3.8).

For LBA 1, fifty-eight hoards contain more than 1,015 metallic elements, or more than seventeen pieces per hoard on average. They are more or less in the interior of the country with no true concentration except in central Brittany and perhaps in southern Lower Normandy (illus 3.9).

With LBA 2, sixty-six hoards contain over 2,685 metallic elements, or more than forty pieces per hoard on average, but the objects are more often broken than previously. Hoards are also more spread than before and they are sometimes represented on the coasts or in major river valleys. Two main concentrations can be seen: in the surroundings of Gironde and lower Dordogne, around Bordeaux, and in the central Paris Basin, from the River Oise to the River Essonne (illus 3.10).

For LBA 3, 212 hoards contain more than 14,761 metallic elements or more than sixty-nine pieces per hoard on average; most are broken, but a very few fragments could be joined to one another. The distribution is extensive, except for the region of Bordeaux. Concentrations can be noted along the maritime coasts, like south Brittany, along the mouths of the biggest rivers and in major river confluences, as around Nantes and Tours on the River Loire, around Paris and Compiègne on the Rivers Seine and Oise, and around Amiens on the River Somme (illus 3.11).

During the earliest Iron Age, the hoarding phenomenon almost disappears: only six hoards have been recorded for the eighth century BC and the first half of the seventh century BC. It shows a big break until the end of the seventh century and the sixth century, which represent a new peak of hoarding in western France – the period of Armorican square-socketed axes.

To sum up, during the LBA, hoarding increases (illus 3.12.1–2) and tends to focus on key points on the major rivers and maritime coasts. This attraction for places where it is easier to control long-distance traffic is probably not a coincidence: we propose to link it with the quick growth of the elite networks. However, the process is probably not as simple and

BRONZE OBJECTS FOR ATLANTIC ELITES IN FRANCE AND BEYOND

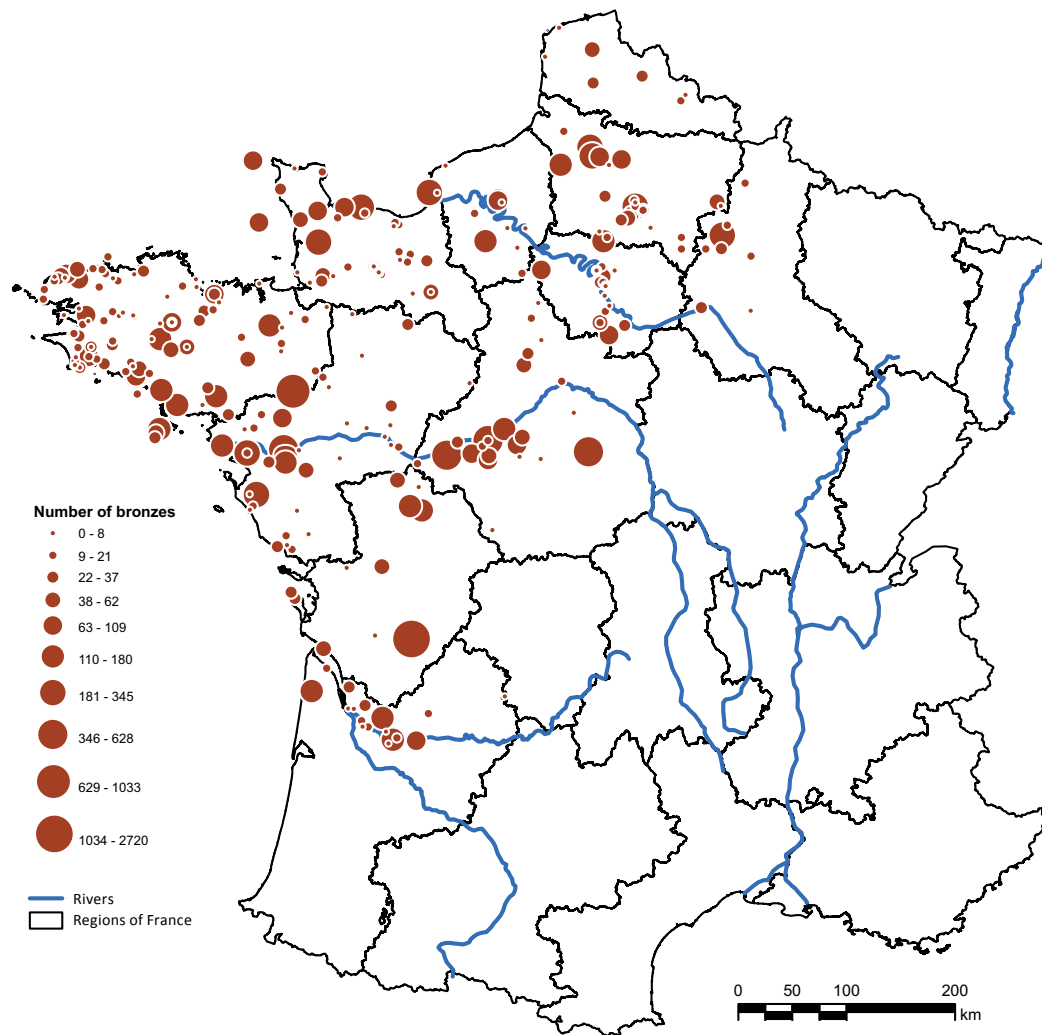

Illustration 3.8

Atlantic hoards dating from the Late Bronze Age in France (342 hoards corresponding to more than 18,000 bronze elements (fragments and complete objects) or fifty-four pieces per hoard on average). Bronzes from rivers are excluded

continuous as usually believed. In contrast to the usual model inherited from the nineteenth century (illus 3.13.1), I think there was no continuous growth of hoarding from the Middle Bronze Age to the beginning of the Iron Age: indeed, two important depressions in hoarding could be observed (illus 3.12.3–4) which are not compensated for with river deposits. We have talked of the first, dating from the eighth century BC, but there is a second one during the middle and later tenth century BC. Unlike Britain, with late Blackmoor and Broadward stages, it is very difficult to identify hoards for this period (the Longueville stage) corresponding to the beginning of LBA 3. This is why it is so easy

to distinguish the classic carp's-tongue hoards from the previous ones of the St-Brieuc-des-Iffs group. This lack of hoards explains some of the problems of chronological correlation mentioned above. In contrast, a very homogeneous and big group such as the classic carp's-tongue hoards from the Vénat stage supposes a brief period of massive depositions, perhaps at the end of LBA 3. Therefore, we should envisage a very irregular curve for the evolution of hoarding (illus 3.13.2).

In conclusion, it is clear that the pattern of hoarding in Atlantic France is not homogeneous and differs, sometimes strongly, from that observed in the British Isles and Iberia. There are also differences

SCOTLAND IN LATER PREHISTORIC EUROPE

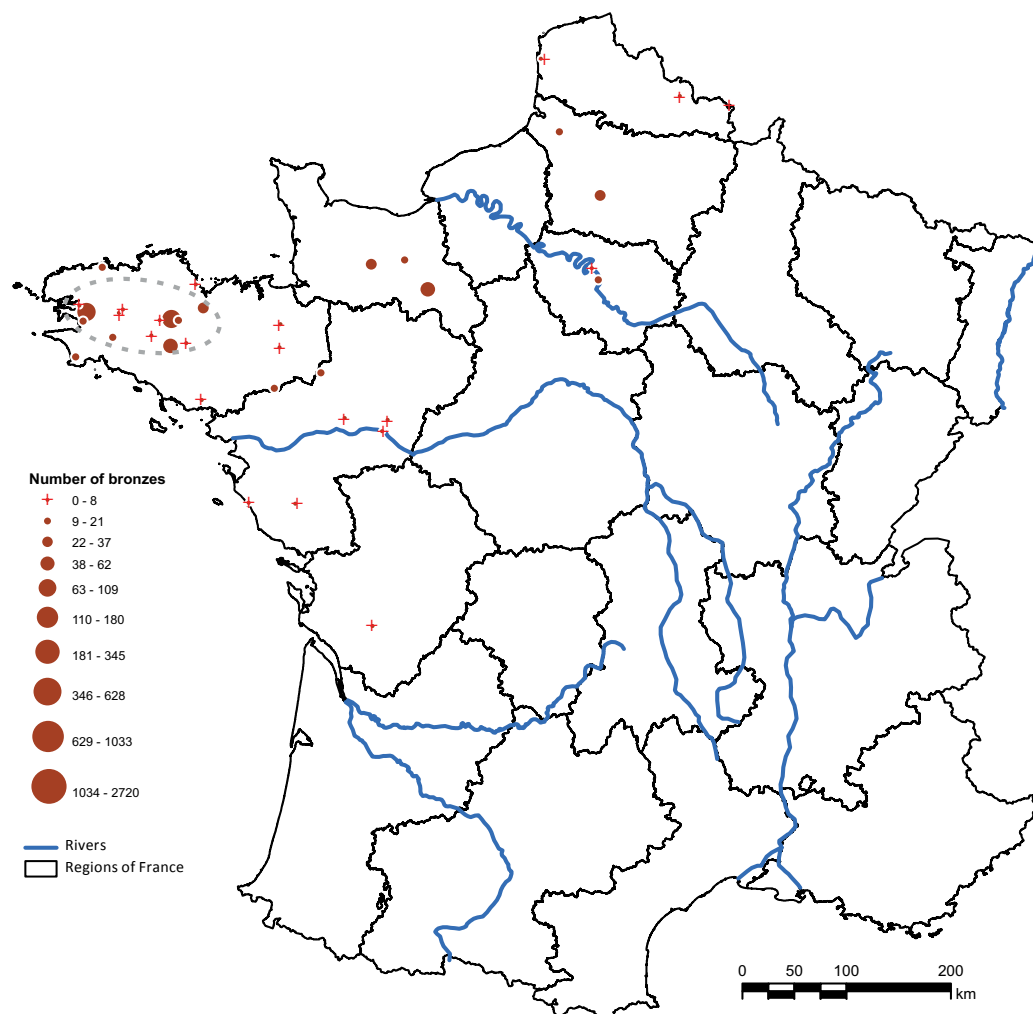

Illustration 3.9

Atlantic hoards dating from LBA 1 in France (fifty-eight hoards corresponding to more than 1,015 bronze elements). Bronzes from rivers and isolated finds are excluded

from region to region in France: for example, the area around Bordeaux is almost the only one to produce hoards during LBA 2. Therefore, if we want to understand the history of Atlantic elite gear in France, we should keep in mind the lack of data for some periods or regions. To avoid misunderstanding, we should also pay attention to elite objects coming from all of the Atlantic area. As examples, the small number and the uniformity of hoards dating from LBA 1 and EIA 1 are a real problem for identifying the origins or the end of many important types of elite gear. Too often, there is a false impression that everything appears during LBA 2 and disappears totally after LBA 3.

History of elite gear

For the rest of this paper I would like to discuss the history of elite gear in Atlantic France and the evolution of Atlantic elites themselves. Of course it is impossible to look at all categories of objects in detail, and I will focus on new things and the problem of the origin of the bronzes: are they imported, imitated, inspired by exotica, or a local invention in the Atlantic context? For this, I will examine the elite gear categorised by different activities (table 3.1).

In the sphere of bodily appearance and beauty, especially during ceremonies, there were probably changes, but these were not extensive. Big gold

BRONZE OBJECTS FOR ATLANTIC ELITES IN FRANCE AND BEYOND

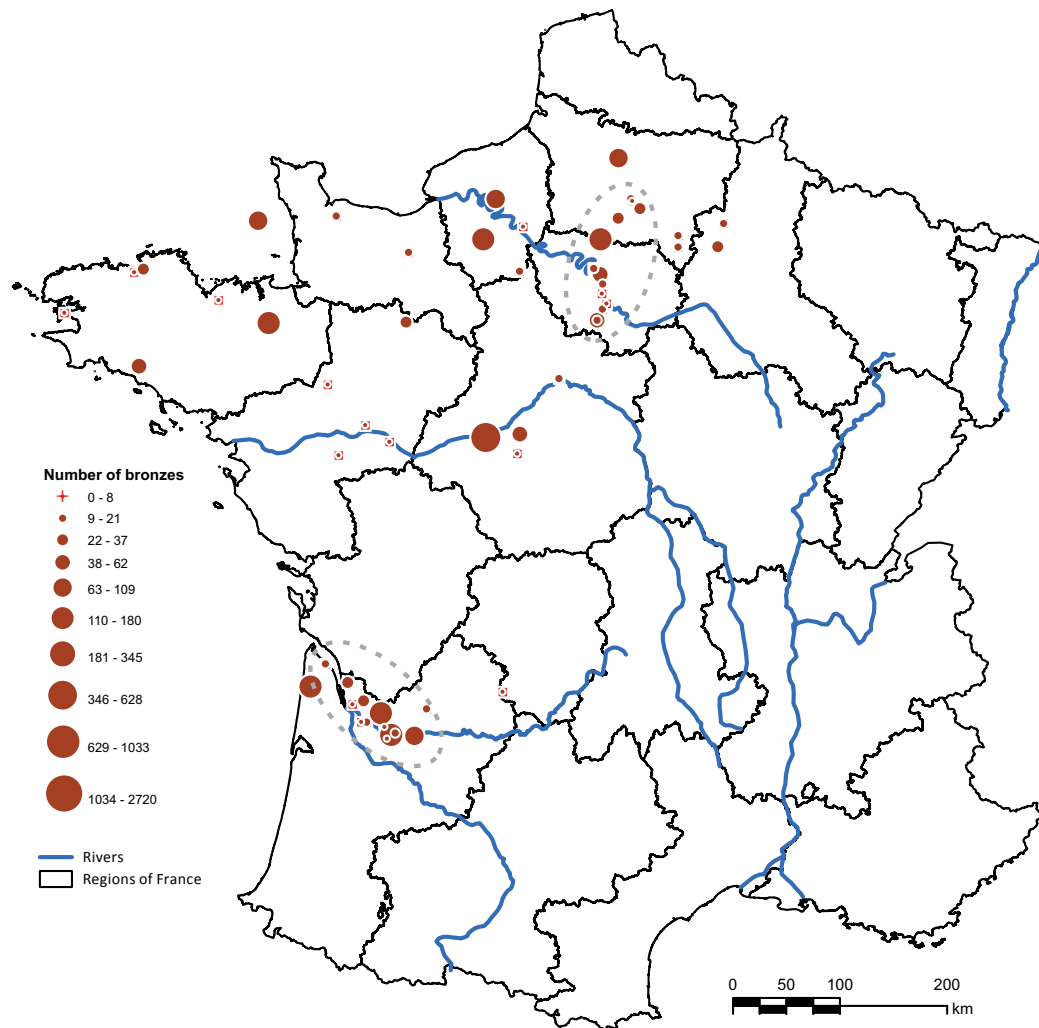

Illustration 3.10

Atlantic hoards dating from LBA 2 in France (sixty-six hoards corresponding to more than 2,685 bronze elements). Bronzes from rivers and isolated finds are excluded

jewellery inspired by the products of the Middle Bronze Age seems to disappear after LBA 1. Smaller objects such as bracelets and rings, sometimes only covered by golden sheet, replace them. For men, there is no true change in razors until the EIA. We note only a new form coming at the very end of LBA 3: the crescent-shaped razors.

Warfare covers a range of activities well known from many types of objects, but the emblematic weapons of the Atlantic elites, the bronze defensive weapons, are mostly lacking in Atlantic France. Apart from imported LBA 2 and LBA 3 objects (Clausing 2002), there are no greaves and cuirasses in Atlantic France, but they were probably known and perhaps

manufactured there because some were found on the fringe of Atlantic France in LBA 1 (a greave in the Cannes-Ecluse hoard II in Seine-et-Marne, for example: Gaucher & Robert 1967, 205, figs 46–8). There are no bronze shields either, but the British and Irish examples let us think that they existed, and the shield's use is attested in Atlantic France by a piece of bronze which covered the central boss of an organic shield (Bangor 'Keriéro', Belle-Île, Morbihan: Boulud 2008, fig 2). We should also mention some possible miniature round shields from Han-sur-Lesse in Belgium, near the French frontier (Warmenbol 2001, 614, pl 1 nos A63–213, A64–207). However, in contrast to the British Isles,

SCOTLAND IN LATER PREHISTORIC EUROPE

Activities	Objects	LBA 1	LBA 2	LBA 3	EIA 1
appearance and beauty	razor	LOCAL	LOCAL	LOCAL	LOCAL
	golden torc	LOCAL			
	golden arm- and leg-ring	LOCAL	LOCAL	LOCAL	
	small golden ring		LOCAL	LOCAL?	
warfare	bronze greave	?	IMPORT		
	bronze cuirass		?	IMPORT?	
	bronze helmet	LOCAL?	LOCAL	LOCAL	
	organic shield with bronze boss			LOCAL	
feasting and sacrifices	cauldron	LOCAL?	LOCAL?	LOCAL	LOCAL
	flesh hook	?	LOCAL	LOCAL	
	rotary spit		LOCAL?	LOCAL	
	bucket		LOCAL?	LOCAL	
	miniature wagon		LOCAL	LOCAL	
	musical instrument			LOCAL	
horse riding and wagon driving	antler cheek piece	?	LOCAL	LOCAL	LOCAL
	metallic cheek piece			LOCAL	LOCAL
	phalera		LOCAL	LOCAL	LOCAL
	rein knob and harness fitting		LOCAL	LOCAL	LOCAL
	wheel fitting	?	IMPORT?	LOCAL	?
	wagon box decoration	?	LOCAL	LOCAL	
	bronze wheel	?	LOCAL?	LOCAL	
	axle-cap		LOCAL?	LOCAL	
	wagon box spool fitting		LOCAL	LOCAL	
	pole axle-cap		LOCAL	LOCAL	
	nailed knob		LOCAL	LOCAL	
	nail and rod		LOCAL?	LOCAL	
	linchpin			LOCAL	
	rein ring		?	LOCAL	LOCAL
	yoke rosette			LOCAL	LOCAL
	yoke rectangular plate			LOCAL	LOCAL
trading	weight	LOCAL	LOCAL		
	beam scale	LOCAL	LOCAL	LOCAL	
long-distance connections	British Isles				
	western north-Alpine complex				
	south Alps/north Italy/Slovenia				
	central/eastern Europe				
	northern Europe				
	Iberia				
	southern France	?	?		
southern Italy/Sicily/Sardinia	?	?			

Table 3.1

Atlantic elite objects in France: synthetic table of the archaeological visibility by sphere of activities. Background colour: white = no evidence; pale blue = limited evidence; dark blue = good evidence

BRONZE OBJECTS FOR ATLANTIC ELITES IN FRANCE AND BEYOND

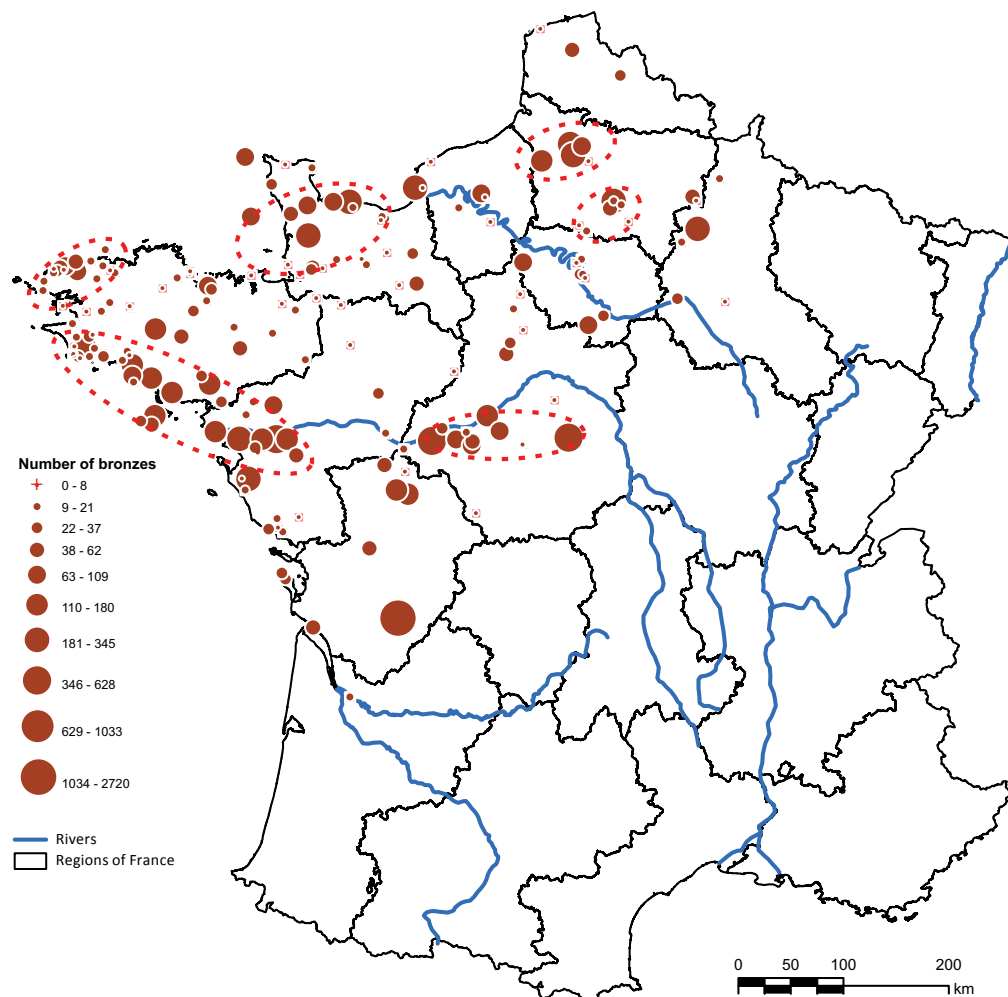

Illustration 3.11

Atlantic hoards dating from LBA 3 in France (212 hoards corresponding to more than 14,761 bronze elements). Bronzes from rivers and isolated finds are excluded

bronze helmets are well represented. Most of them are LBA 2 or early LBA 3, but there is an earlier one-piece example (without studs), probably dating from LBA 1, from the Seine at Mantes-la-Jolie (illus 3.14.1). This should be one of the prototypes for the Atlantic crested helmet series with projecting studs (illus 3.14.2–3).

In fact, despite their large scale, defensive weapons are difficult to identify when they are broken into small pieces: many fragments of bronze sheet could belong to this kind of object. We cannot be certain, but Atlantic bronze defensive weapons were probably in use as early as the beginning of the LBA. A central European or eastern Mediterranean origin for them has long been claimed, but there is no clear evidence

this was the case, except perhaps for the first crested helmets (Schauer 2003). We do not know what happened to these defensive weapons after the Early LBA 3.

Feasting items are well represented. The cooking and serving of meat during feasts is known from flesh-hooks and rotary spits. The former are known from LBA 2 (three examples) and are numerous during LBA 3 (twenty-seven examples), but the oldest flesh-hooks from Ireland and England (Bowman & Needham 2007) provide an argument for their possible use in Atlantic France since LBA 1. Moreover, a LBA 1 flesh-hook comes from the fringe of Atlantic France, although it is a north Alpine form (Cannes-Ecluse I: Gaucher & Robert 1967, 201). These objects

SCOTLAND IN LATER PREHISTORIC EUROPE

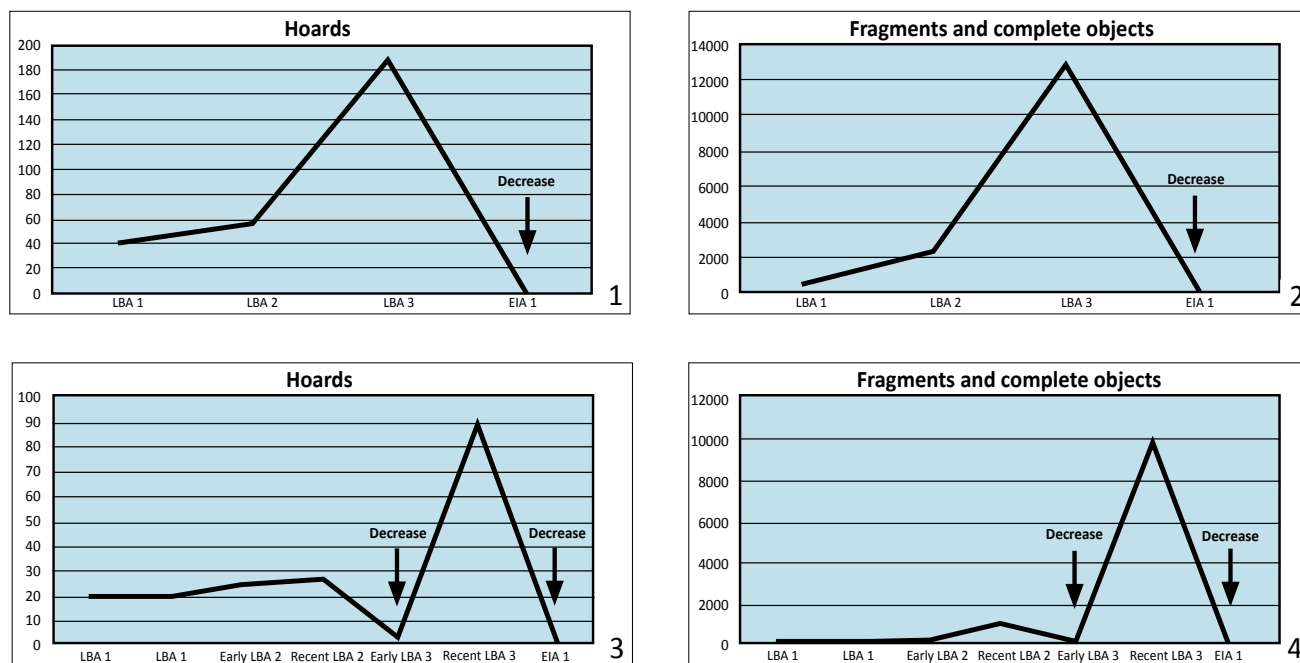

Illustration 3.12

Numbers of hoards and bronze objects in hoards known in Atlantic France for LBA and EIA 1 (bronzes from rivers are excluded). The distributions are based on the traditional chronology (1 and 2) and on a detailed chronology (3 and 4). On graphs 3 and 4, the numbers correspond only to the well-dated hoards: therefore, they are probably underestimated for early LBA 3 and overestimated for later LBA 3

were in use long before in the eastern Mediterranean and probably spread from there. However, their route to the Atlantic complex is not clear: by central Europe or by Sicily? Concerning rotary spits, eight are known in Atlantic France and Jersey (Burgess & O'Connor 2004; personal observations), with one probable fragment dating from LBA 2. With rotary spits a new aesthetic is introduced, with the schematic representation of animals such as birds and quadrupeds. Such rotary spits with their new decoration appear after the flesh-hooks and seem to come from south. We rather agree with Burgess & O'Connor (2004, 194–5) for a western Iberian invention under Sardinian influences.

Furthermore, preparation of meat and especially of alcohol involved cauldrons and buckets. At least nine or ten cauldrons are known (Gerloff 2010; personal observations), but often in the form of fragments, as we have seen. The oldest, from the Rosnoën hoard in Saint-Igeaux, dates from LBA 1 and seems to differ a little from the earliest British cauldrons. Due to their number and the large chronological span, the French Atlantic cauldrons could be local products rather than imports from the British Isles. Concerning the

origins of the earliest Atlantic cauldrons, an eastern Mediterranean origin relayed by central European influences is supported by Sabine Gerloff (1986, 107; 2004, 126). However, with the early dates associated with the Atlantic cauldrons of Saint-Igeaux and Feltwell (Norfolk),⁵ the question is still open because the so-called prototypes or ancestors in central Europe and Mycenaean Greece are not, for the moment, very much earlier.

The buckets are badly known for the same reason as cauldrons. Fragments of eight or nine buckets are recorded and dated from LBA 3 (perhaps, for one fragment, from LBA 2). Like the cauldrons, the buckets could be a local Atlantic production in France influenced by earlier central European and Mycenaean vessels if we follow Gerloff's interpretation (2004, 126).

A final category of feasting gear is perhaps the most important in terms of sacred or magical use: model wagons which probably carried a symbolic small vase. Fragments of at least three are recorded, and belong to LBA 2 and 3 (Chevillot & Gomez 1979). These bronze objects are exceptional because very few are known outside the Mediterranean world. They come from

BRONZE OBJECTS FOR ATLANTIC ELITES IN FRANCE AND BEYOND

northern, central and eastern Europe and are often older than the French examples (Pare 1992, chapter 12). The French model wagons were probably inspired by central European prototypes, but another kind of influence linked to the central Mediterranean, perhaps via Portugal, cannot be totally rejected. Fragments of such objects were discovered in the Baiões castro (Silva 1986, pl 96), probably dating from later LBA 2 (Burgess & O'Connor 2004, 194) or early LBA 3.

In summary, the development of Atlantic feasting gear shows two steps in France. The first, at the beginning of LBA 1, sees the adoption of both cauldrons and flesh-hooks (and buckets?). During a second step, dated to LBA 2, buckets(?), model wagons and rotary spits were adopted. The concept and use of most of these objects came from the eastern Mediterranean sea, but the influence is indirect and took different routes. Central Europe perhaps played a major role, notably during the first step. Western Iberia (and the isles of the central Mediterranean?) could also have played an important role in diffusion, as we have seen with model wagons and rotary spits, but later.

Horse riding and wagon driving were perhaps the most emblematic activities for the LBA elites. Some horse gear predates the LBA in France, as in Britain (Balkwill 1973), but these are made of bone or antler,

and we have to wait until LBA 2 to have some cheek pieces and horse-bits in bronze. These objects are not numerous, even in LBA 3, but many other bronzes, such as most of the buttons and phalerae, belong probably to horse gear. All these products, particularly

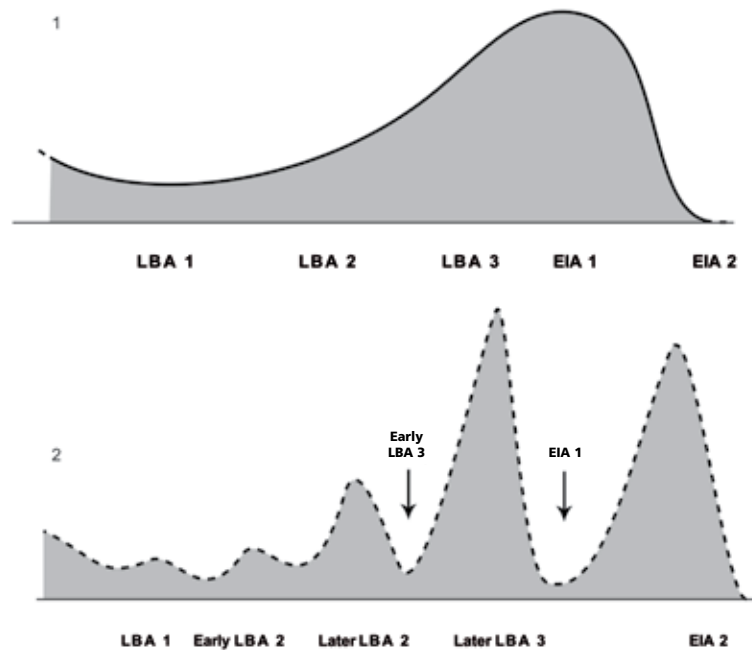

Illustration 3.13

Interpretative curves of hoarding in Atlantic France for LBA and EIA 1 and 2 (c 1300 to c 255 BC). 1 traditional supposed curve based on the traditional chronology; 2 more probable curve based on a detailed chronology (the peak of EIA 2 essentially corresponds to the hoarding of Armorican axes). Bronzes in rivers and graves would give different curves but could not fill the depressions

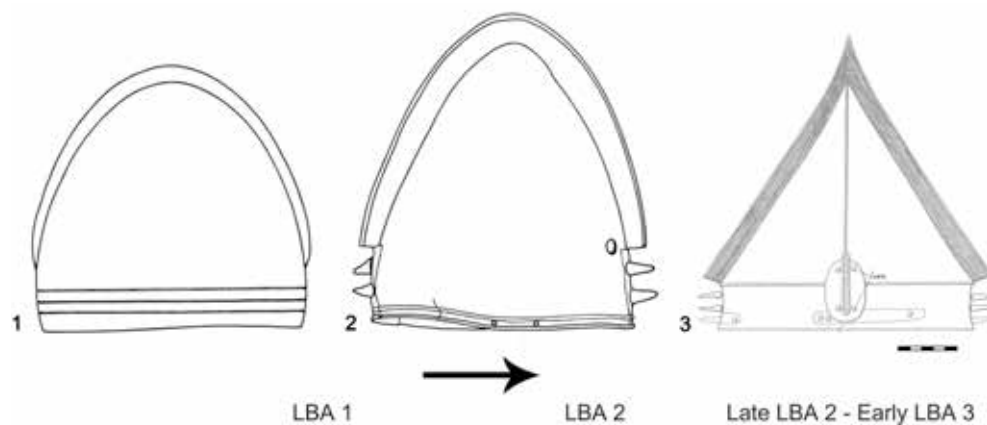

Illustration 3.14

Chronological evolution of helmets discovered in Atlantic France. 1 Mantes-la-Jolie (Yvelines) (after Mohen 1977, fig 503); 2 Paris (after Mohen 1977, fig 502); 3 Falaise (Calvados) (Hencken 1971, fig 41C)

SCOTLAND IN LATER PREHISTORIC EUROPE

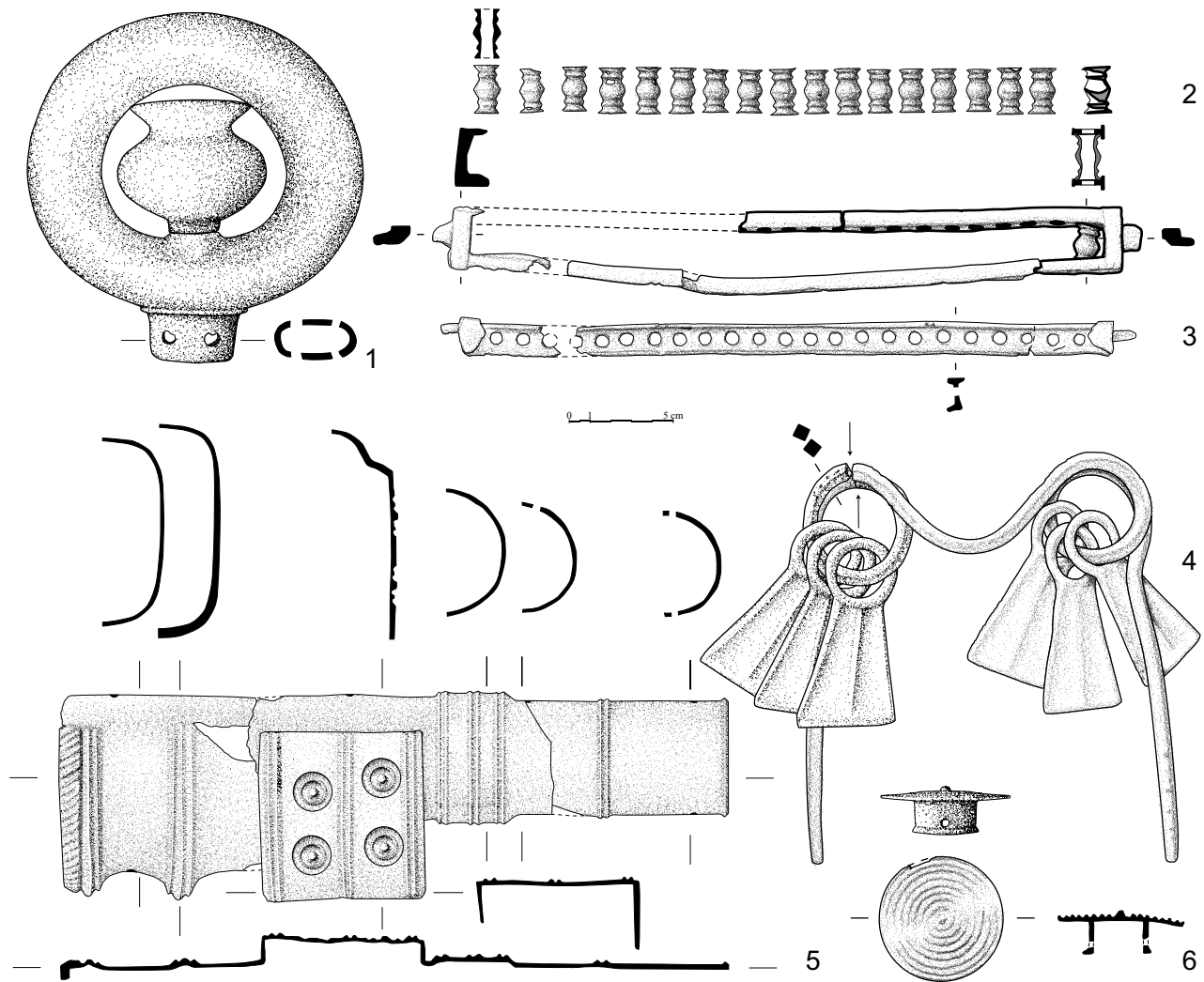

Illustration 3.15
Some objects from an Atlantic wagon fittings hoard: Onzain (Loir-et-Cher). Drawing: Nathalie Gomes

the oldest, often show a clear resemblance to the north Alpine horse gear tradition.

The use of wagons is well recorded for the same stages (LBA 2 and 3; Gomez de Soto 1984; Milcent & Leroy 2003; Pare 2004), but we should remember that we are talking only about wagons constructed or decorated with metallic pieces (most were probably war chariots or ceremonial wagons); indeed, some vehicles made only of wood are older in Atlantic Europe. The Atlantic bronze pieces dating from LBA 2 are clearly and strongly inspired by north Alpine products,⁶ essentially the Hart an der Alz group defined by Christopher Pare (1992, 23–8). But with LBA 3 we can observe new forms of pieces, as in

the exceptional hoard discovered in Onzain, Loir-et-Cher, which contained ninety-eight pieces of an Atlantic four-wheeled wagon (Milcent & Leroy 2003; illus 3.15). At this stage, the number of wagon fittings coming from hoards is very impressive. To give an idea, about 160 wheel fragments or elements are recorded for LBA 2 and LBA 3 in Atlantic France. This is a real difference from other Atlantic regions where wagons are few, as in Scotland,⁷ or unknown, as in western Iberia (excepting depictions on stelae in Extremadura and beyond). Some of these objects, belonging to the Bad-Homburg/Onzain group, were still in use during the earliest Iron Age in Atlantic regions, but seem to spread also to eastern France,

BRONZE OBJECTS FOR ATLANTIC ELITES IN FRANCE AND BEYOND

south Germany (Wehringen, for example) and Denmark (Voldtofte, for instance) (Milcent & Leroy 2003; Pare 2004).

Elite exchanges, travels and long distance contacts are documented by a few finds of weights, beam scales and, above all, by a great quantity of exotica. If the weights and beam scales are currently only well attested during LBA 2 and 3 (Peake et al 1999),⁸ the exotica are very well represented throughout the LBA; more than five hundred objects are recorded so far. The biggest proportion of imports are north Alpine and British axes (illus 3.16). Swords and bracelets, mostly north Alpine, are also well represented. As can be seen on table 3.1, long-distance exchanges developed as early as LBA 1, but the diversification of the exchanges, especially in the direction of southern Europe, becomes visible only with LBA 2. LBA 3 is an important period because we can see objects coming

from all of western Europe. However, north Alpine and British imports continue to be the predominant exotica. The situation is probably changing with the EIA 1, but we do not have enough objects for this period in Atlantic France to know what happened. Nevertheless, some Atlantic exports in eastern France and south Germany, such as axes, swords, chapes, razors and wagons, show that long-distance exchanges did not collapse totally.

To finish, we would like to sum up the situation, stage by stage. As can be seen for different periods, especially LBA 1 and 2, our conclusions are more or less in agreement with some of Colin Burgess' hypothesis about the emergence of the Atlantic LBA (Burgess 1991; Burgess & O'Connor 2004).

For LBA 1, despite the small numbers of discoveries, every sphere of elite activities seems to be represented by a few artefacts in Atlantic France,

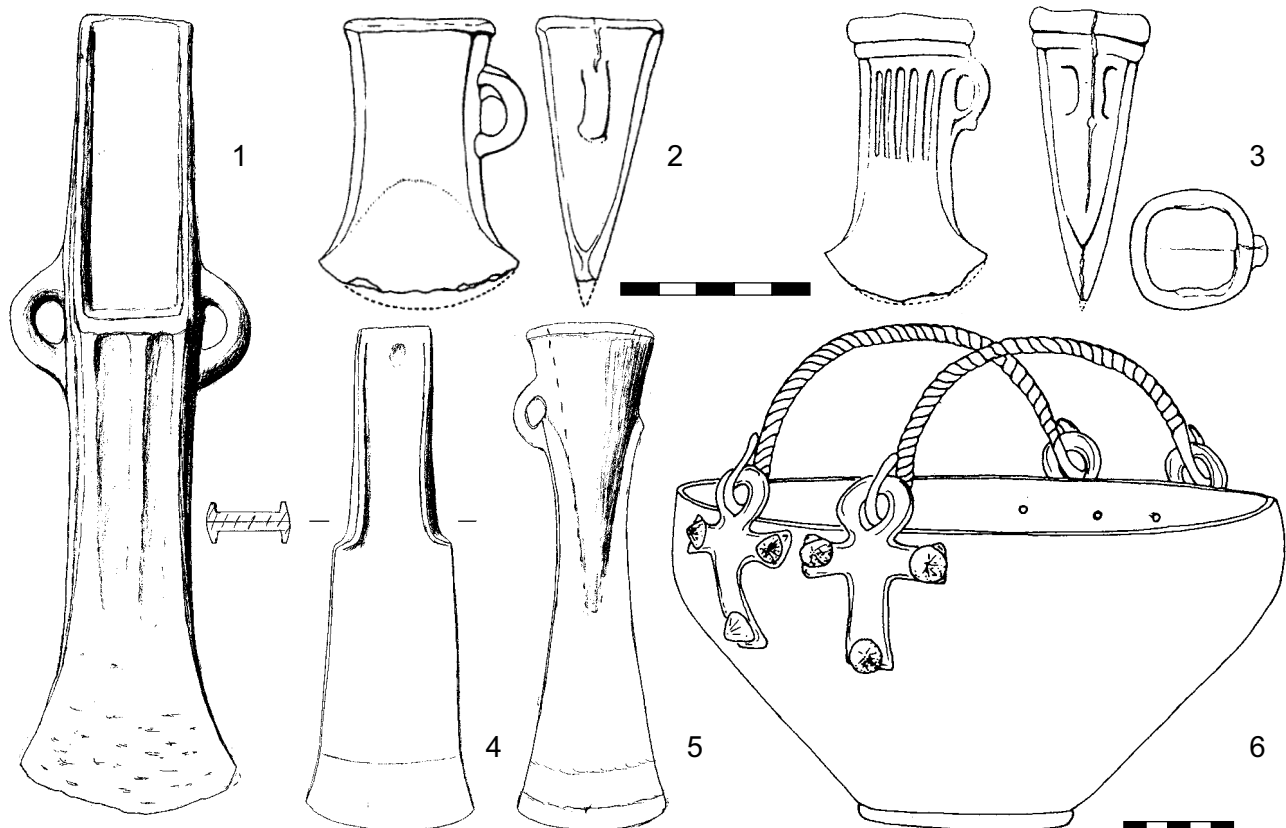

Illustration 3.16

Examples of exotica dating from LBA 3 in Atlantic France, coming from north-western Iberia (1), northern and eastern Great Britain (2–3), Italy (4), Poland (5) and central Europe (6). 1 Le Folgoët (Finistère); 2–3 Juvincourt-et-Damary (Aisne) (Jöckenhövel & Smolla 1975, fig 3); 4 Amboise (Indre-et-Loire); 5 Luynes (Indre-et-Loire); 6 Vieux-Moulin (Oise) (Blanchet 1984, fig 218)

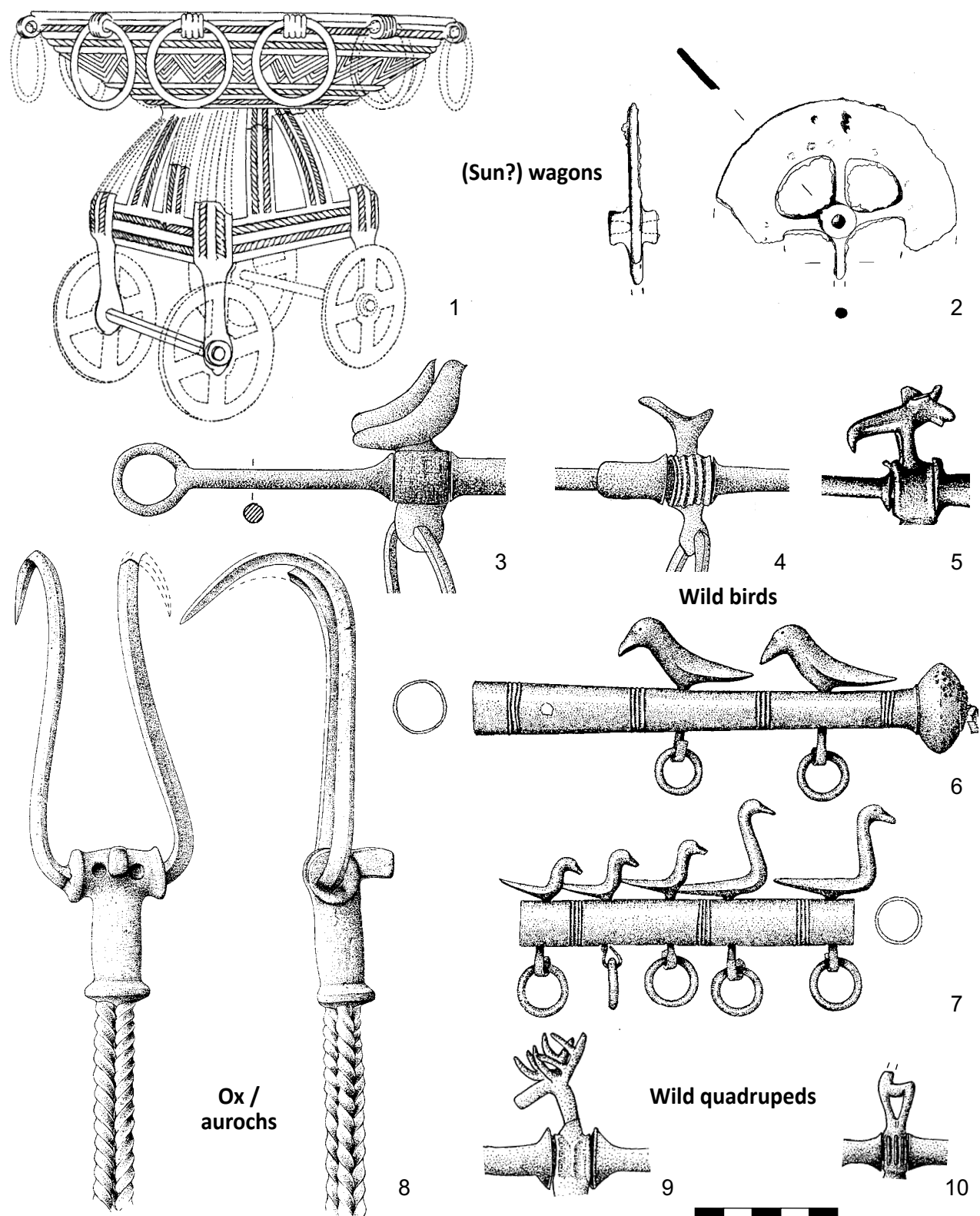

Illustration 3.17

Depictions on elite gear from the whole Atlantic cultural complex. 1–2 miniature wagons from Baiões (Viseu) (Silva 1986, pl 96) and Saint-Yrieix 'Vénat' (Charente); 3–5 rotary spits from Serra de Alvaiázere (Extremadura) (Coffyn 1985, fig 22 no 1), Forêt de Compiègne (Oise) (Coffyn 1985, fig 22 no 2, after Mohen) and Port-Sainte-Foy (Dordogne) (Chevillot 1989, pl 324); 6–8 flesh hooks from Dunaverney (Co Antrim) (Bowman & Needham 2007, figs 10–11) and Cantabrana (Burgos) (Delibes de Castro et al 1999, no 99); 9–10 rotary spits from Challans (Vendée) (Coffyn 1985, fig 51 no 2, after Mohen) and Mirebeau (Vienne) (Coffyn 1985, fig 51 no 4, after Mohen)

BRONZE OBJECTS FOR ATLANTIC ELITES IN FRANCE AND BEYOND

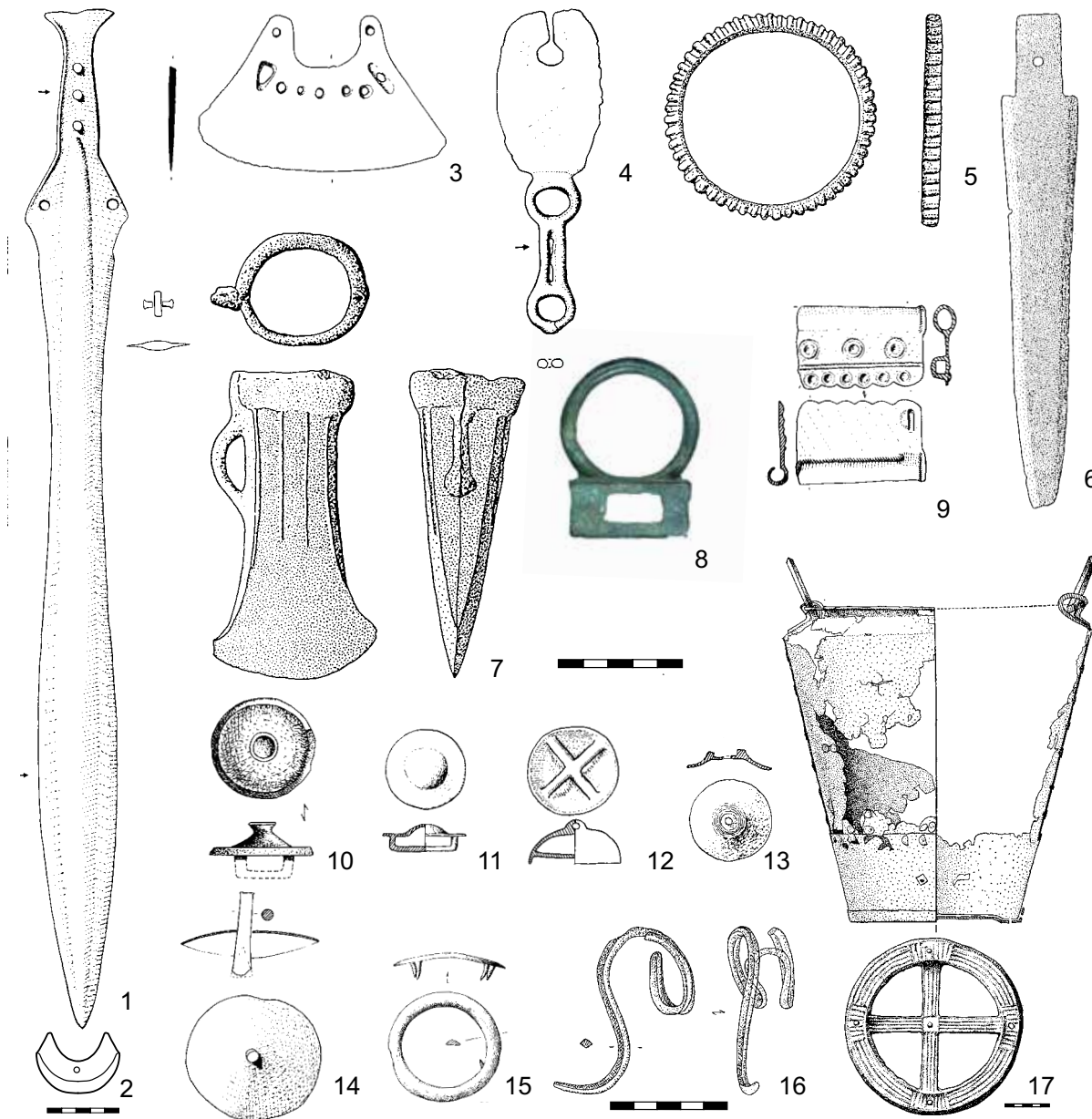

Illustration 3.18

Classical Atlantic elite gear of LBA 3 discovered in Atlantic France (with one exception). 1 Paris (after Mohen 1977, no 189); 2, 9, 11–14 Saint-Yrieix (Charente) 'Vénat' (after Coffyn et al 1981); 3 Landéda (Finistère); 4 Corbeil (Essonne) (Mohen 1977, no 178); 5–7 Mougou (Deux-Sèvres) (Pautreau et al 1984); 8 Déville-lès-Rouen (Seine-Maritime); 10 Nantes (Loire-Atlantique) 'Prairie de Mauves' (Briard 1966, pl 18); 15 Neuvy-sur-Barangeon (Cher) (Cordier 1996); 16 Langoëlan (Finistère) (Briard 1991, fig 6 no 12); 17 Heathy Burn Cave (Durham) (Britton & Longworth 1968, pl 10(4) no 58)

except perhaps ceremonial wagon use. LBA 1 is the period of introduction or invention of defensive bronze weapons (notably earlier crested helmets) and of the feasting set composed by cauldrons, buckets(?) and flesh-hooks. Long-distance exchanges are well documented. Many influences seem to come from

the north Alpine area, but some objects may also have been developed regionally and independently in the Atlantic cultural complex (shields and cauldrons for instance?). In this context, northern Atlantic France must have played an important role in the spread of these new objects.

SCOTLAND IN LATER PREHISTORIC EUROPE

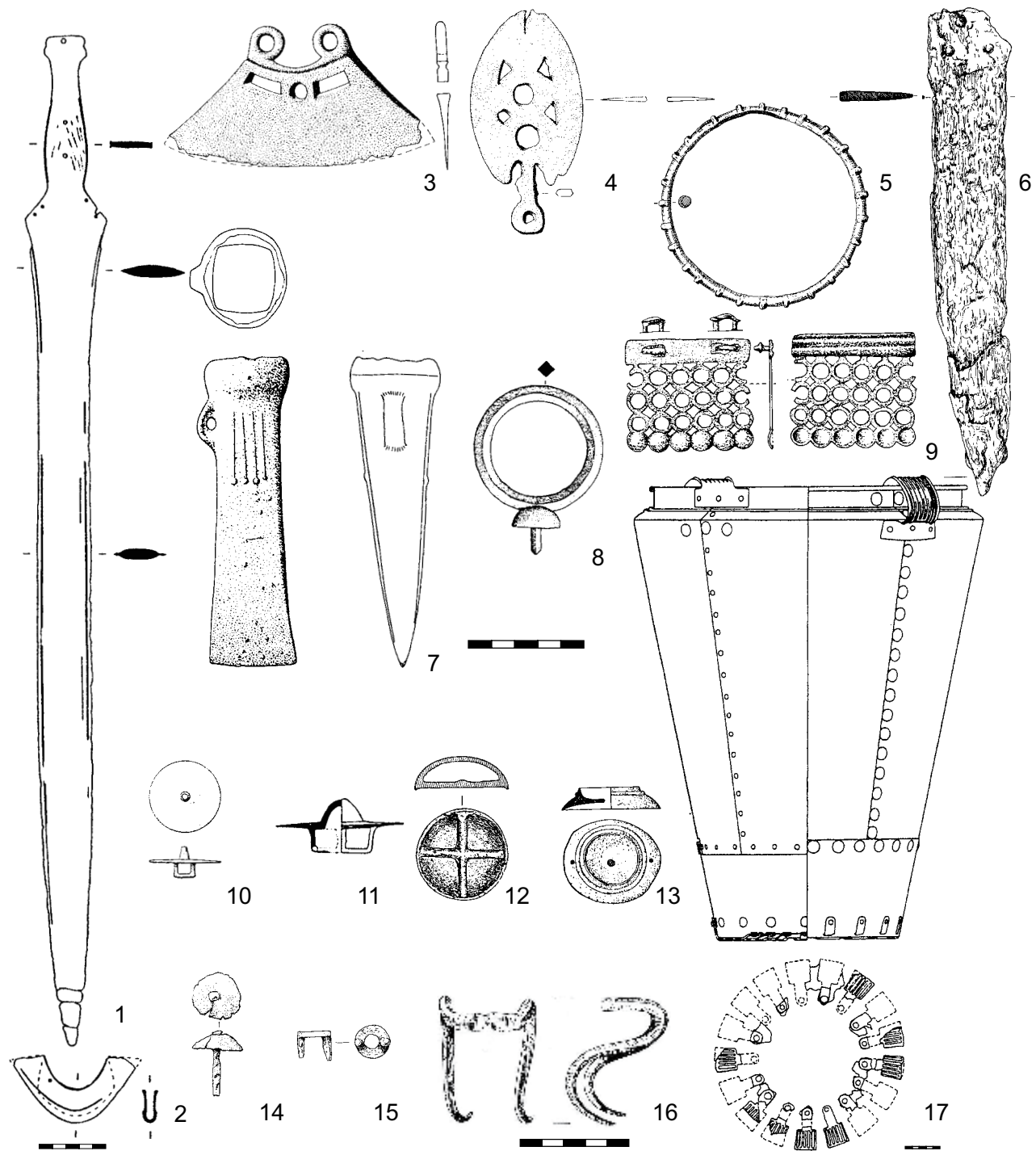

Illustration 3.19

The Atlantic components of western Hallstatt C elite gear: Hallstatt C objects discovered mostly in eastern France and southern Germany which seem to be imported from Atlantic regions or imitate Atlantic Late Bronze Age productions. 1–2 Villement (Indre) ‘Saint-Aoustrille’ T.6 S.1 (Milcent 2004, pl 69); 3 Feldkirch-Hartheim (Baden-Württemberg) ‘Retthammer’ S.1 (Jockenhövel 1971, pl 38 no 573); 4 Wiesloch (Baden-Württemberg) S.3 (Jockenhövel 1971, pl 28 no 364); 5 Esslingen (Württemberg) (Zürn 1987, pl 78); 6, 9 Großleibstadt (Unterfranken) S.1 (Kossack 1970); 7 Bingen (Rheinland-Pfalz) (Pare 1999, pl VII); 8 Breisach-am-Rhein (Bade) ‘Zwölferbuck’ (Pare 1992, pl 32); 10 Nymburk-Habeš (Bohemia) (Pare 1992, pl 120); 11 Rvenice (Bohemia) S.1966 (Pare 1999, fig 102); 12 Frankfurt Stadtwald (Hesse) S.12 (Fischer 1979); 13 Thalmäding (Mittelfranken) (Kossack 1959, fig 23); 14 Poláky (Bohemia) S.21 (Pare 1992, pl 122); 15 Hohenstein-Oberstetten (Württemberg) (Zürn 1987, pl 242); 16 Hallstatt (Salzkammergut) S.263 (Kromer 1959); 17 La Côte-Saint-André (Isère) (Gerloff 2004)

BRONZE OBJECTS FOR ATLANTIC ELITES IN FRANCE AND BEYOND

During LBA 2, two processes are notable. Firstly, there is the growth of original products which are typically Atlantic but developed from prototypes dating from LBA 1. Among them we should mention precision weights and scales, advanced crested helmets, multi-sheet vessels with ribbed tubular attachments, and sophisticated flesh-hooks. We could see also a trend of standardisation at the scale of the Atlantic complex. Secondly, there is a second wave of adoption of elite

sets of bronzes, such as rotary spits, model wagons, and perhaps horses and wagon gear. This process is accompanied by the introduction of a new aesthetic, with small-scale reproductions of objects like wagons and vessels, and depictions of animals (illus 3.17). If some of these new things are coming through the north Alpine complex (such as wagon models and ceremonial wagons), some are also coming through Iberia. It is the result of a real integration of western Iberia to the

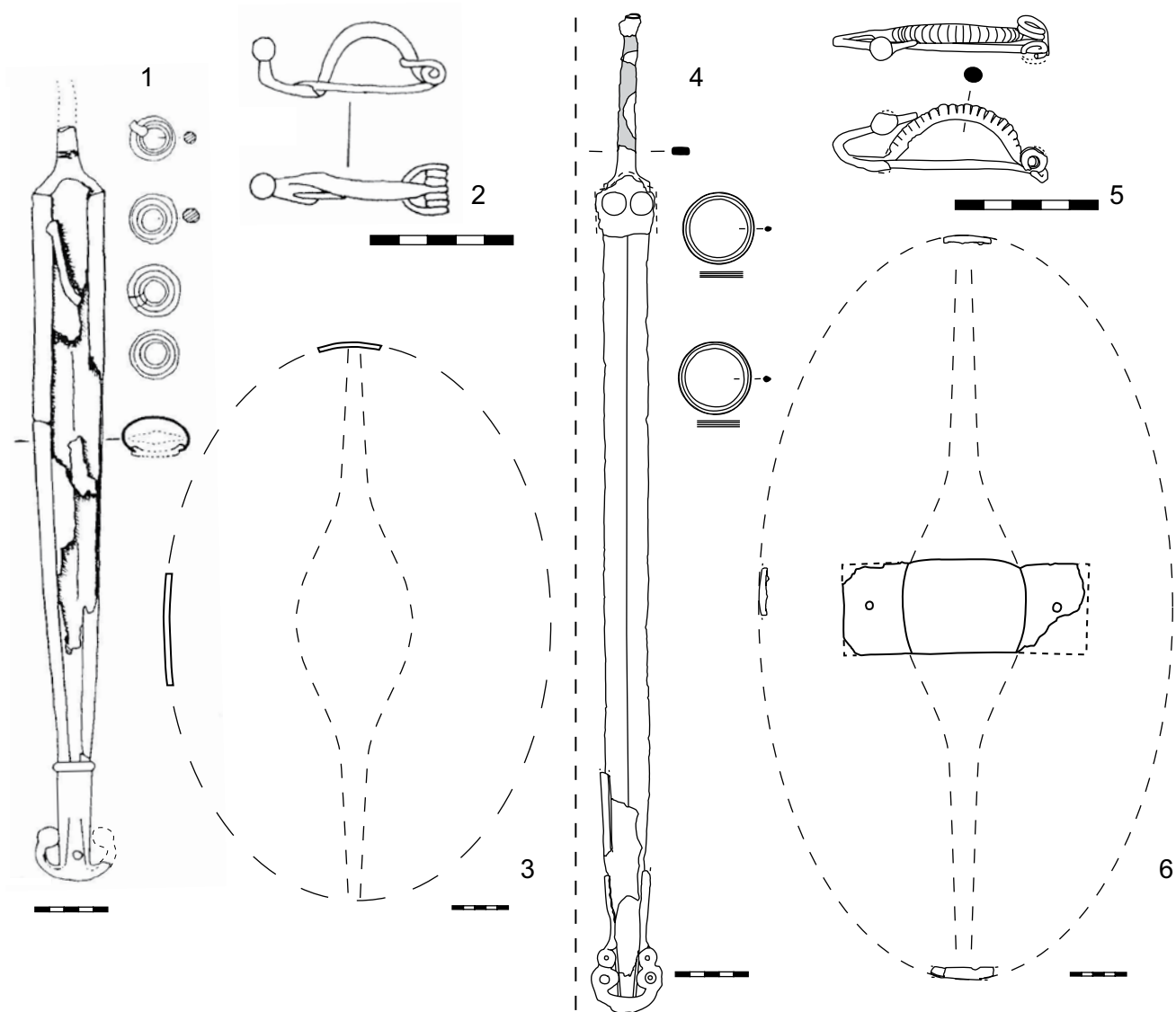

Illustration 3.20

Atlantic components in La Tène artefacts. La Tène B-C1 objects from central France (fourth–third century BC) (4–6) and their probable early prototypes in the Atlantic late EIA (second half of sixth century BC) (1–3). 1 Saint-Gibrien (Marne) (Charpy 1995); 2 Chouilly (Marne) « Les Jogasses » S.145 (Hatt & Roualet 1976); 3 Chaillon (Meuse) S.1018 (inspired by Landolt 2005); 4 Moulin-sur-Yèvre (Cher) « Maubranches » S.2; 5 Bourges (Cher) « Chemin de Gionne » S.8; 6 Moulin-sur-Yèvre (Cher) « Maubranches » S.1

SCOTLAND IN LATER PREHISTORIC EUROPE

Atlantic elite networks, as the spread of early carp's-tongue swords shows.⁹ This gave the opportunity to connect more directly the Atlantic cultural complex with western and central Mediterranean.

With LBA 3, there is no more important borrowing, albeit long-distance exchanges seem to reach a peak. LBA 3 was a period of achievement for the elaboration of a specific Atlantic elite set and the difference with north Alpine elite gear becomes important (illus 3.18).

EIA 1 is certainly a period of break, for example with the eclipse of hoarding or the real start of iron metallurgy. However there is a paradox with Atlantic elite objects because they are in true continuity with the products of LBA 3. The very big change for the elite gear is in fact visible outside of the Atlantic complex. In the western part of the north Alpine complex, for the first time the elites abandoned most of their emblematic objects and seem to adopt a kind of Atlantic way of life: they probably imported more Atlantic elite objects than before and, above all, their workshops quickly imitated, then modified, some Atlantic products. Indeed, many of the western Hallstatt elite gears, such as flange-hilted swords and bag chapes, trapezoidal and oval razors,¹⁰ buckets with tabbed rectangular base-plates,¹¹ wagons and horse fittings close to the Bad-Homburg/Onzain group, battle or ceremonial socketed axes, ribbed bracelets (perhaps also cauldrons, class 1 flesh-hooks and some types of knives with riveted flat hilts) have their models or some features of inspiration in Atlantic LBA 3 (Milcent 1998, chapter 1; 2004, 108–12; 2009; illus 3.18–19).

Conclusion

In France, even today, the Atlantic cultural complex is often still seen as a periphery of ancient Europe, lagging behind culturally and with no real contacts with the Mediterranean or south-eastern Europe before the Late Iron Age. Innovations and changes are mostly attributed to contacts with or through the north Alpine complex. Too often the Atlantic LBA in France is supposed to be a period with a more or less simple social and economic organisation, simpler than in the Iron Ages, with a gradual evolution in the direction of technical progress and more complexity. However, this diffusionist and evolutionist point of view is attacked by many facts. We should not deny the strong influences coming from central Europe, but this is only true for a limited period (LBA 1 and

perhaps the beginning of LBA 2), and central Europe did not have a monopoly. Northern Europe, Iberia, central Mediterranean and probably southern France also had many connections with Atlantic France.

Moreover, the earliest Iron Age clearly shows an inversion of the supposed traditional positions: we could see a strong influence of the north Atlantic complex on the western north Alpine regions. A large part of the so-called Hallstatt elite gear has in fact an Atlantic origin or source of inspiration. This phenomenon is not exceptional or isolated: we have pointed recently to the important Atlantic contribution to the elaboration of the first La Tène elite material culture during the fifth century BC (Milcent 2006; 2009; illus 3.20; see also Cunliffe, this volume).

To conclude, it seems clear that some of the features generally associated with the Iron Age are in fact represented in Atlantic LBA societies, even if not at the same scale: we could mention in particular the production of very complex objects such as ceremonial wagons, big feasting gear, the adoption of small plastic figurines, the import of southern objects, the strong influence of the elite's way of life from the eastern Mediterranean, and the construction of an elaborated and original elite society on a wide geographic scale.

Notes

- ¹ Rods were identified as parts of helmet rivets at Flag Fen Power Station and the Nottingham Hill hoard (Coombs 1992, 509), but comparison with continental finds is not convincing.
- ² See also Brun 1991, 16.
- ³ The conclusion of this study was first published (Milcent 1997) and then developed in a PhD more than ten years ago (Milcent 1998), but only published in detail in 2004.
- ⁴ The hoards with classical Armorican axes are excluded from the study and inventory because they are later than the eighth century BC.
- ⁵ The hoard of Feltwell is dated to 3013 ± 36 BP, calibrating with 95% probability to 1390–1120 cal BC (Bronk Ramsey et al 2002, 41).
- ⁶ Wagon pieces coming from the hoard of Canteleu (Seine-Maritime) 'Biessard' for example (Verron 1971, no 35; O'Connor 1980, fig. 49C no 3).
- ⁷ See the hoards of St Andrews (Cowie et al 1991) and especially Horsehope Craig (Piggott 1953).
- ⁸ But there is probably an example of a beam scale in Charente dating from the end of the Middle Bronze Age (Peake et al 1999).
- ⁹ For the chronology, diffusion and question of the origins of carp's-tongue swords, see Brandherm & Burgess 2008. The authors support the idea of a diffusion as early as the end of the eleventh or beginning of the tenth century from Iberia.

BRONZE OBJECTS FOR ATLANTIC ELITES IN FRANCE AND BEYOND

- ¹⁰ Albrecht Jockenhövel (1980, 175) has seen before us the western concentration and origin of some trapezoidal Hallstatt C razors (Feldkirch/Bernissart type), but we think that an Atlantic origin or inspiration is probable for many of the Hallstatt C razors spread in western central Europe.
- ¹¹ For the Atlantic influences upon the Iron Age buckets coming from Italy and the north Alpine complex, see Gerloff 2004, 138–41.

References

- Bailloud, G & Mohen, J P 1987 *La vie quotidienne. Les fouilles du Fort-Harrouard*. Paris: Picard (=L'âge du Bronze en France 4).
- Balkwill, C J 1973 'The earliest horse-bits of western Europe', *Proceedings of the Prehistoric Society* 39, 425–52.
- Billand, G & Talon, M 2007 'Apport du Bronze Age Studies Group au vieillissement des "hair-rings" dans le Nord de la France', in Burgess et al (eds), 342–51.
- Blanchet, J-C 1984 *Les premiers métallurgistes en Picardie et dans le nord de la France: chalcolithique, âge du Bronze et début du premier âge du Fer*. Paris: Société Préhistorique Française (=Mémoire 17).
- Boulud, S 2008 'Deux dépôts de l'horizon de l'épée en langue de carpe découverts récemment à Belle-Île (Morbihan): présentation liminaire', *Bulletin de l'Association pour la Promotion des Recherches sur l'Âge du Bronze* 5, 6–8.
- Boutoille, L & Milcent, P-Y 2006 'De l'épée du guerrier au racloir: l'outillage de seconde intention dans les dépôts métalliques du Bronze final atlantique trouvés en France', in Astruc L, Bon, F, Lea, L, Philibert, S & Milcent, P-Y (eds) *Normes techniques et pratiques sociales. De la simplicité des outillages pré- et protohistoriques. Actes des XXVF rencontres internationales d'archéologie et d'histoire d'Antibes, 20–22 octobre 2005*, 297–311. Antibes: APDCA.
- Bowman, S & Needham, S 2007 'The Dunaverney and Little Thetford flesh-hooks: history, technology and their position within the Later Bronze Age Atlantic zone feasting complex', *Antiquaries Journal* 87, 53–108.
- Brandherm, D 2007 *Las Espadas del Bronce Final en la Península Ibérica y Baleares*. Stuttgart: Franz Steiner Verlag (=Prähistorische Bronzefunde IV, 16).
- Brandherm, D & Burgess, C 2008 'Carp's-tongue problems', in von Verse, F, Knoche, B, Graefe, J et al (eds) *Durch die Zeiten. Festschrift für Albrecht Jockenhövel zum 65. Geburtstag*, 133–68. Rahden/Westfalen: Verlag Marie Leidorf (=Internationale Archäologie, Studia honoraria 28).
- Breuil, H 1900 'L'âge du bronze dans le bassin de Paris. I. – Les épées et dagues du bassin de la Somme', *L'Anthropologie* 11, 503–34.
- Briard, J 1965 *Les dépôts bretons et l'âge du Bronze atlantique*. Thèse de Sciences naturelles, Université de Rennes.
- Briard, J 1966 *Dépôts de l'âge du Bronze en Bretagne: La Prairie de Mauves à Nantes*. Rennes: Laboratoire d'anthropologie préhistorique.
- Briard, J 1991 'Le groupe de l'épée en langue de carpe en Armorique: une révision', in Chevillot & Coffyn (eds), 125–44.
- Britnell, W J 1976 'Antler cheekpieces of the British Late Bronze Age', *Antiquaries Journal* 56, 24–34.
- Britton, D & Longworth, I H 1968 *Late Bronze Age Finds in the Heathery Burn Cave, Co Durham*. London: British Museum (=Inventaria Archaeologica, Great Britain, ninth set, GB.55).
- Bronk Ramsey, C, Higham, T F G, Owen, D C, Pike, A W G & Hedges, R E M 2002 'Radiocarbon dates from the Oxford AMS System: Archaeometry datelist 31', *Archaeometry* 44/3, supplement 1, 1–149.
- Brun, P 1991 'Le Bronze atlantique et ses subdivisions culturelles: essai de définition', in Chevillot & Coffyn (eds), 11–24.
- Burgess, C 1991 'The east and the west: Mediterranean influence in the Atlantic world in the later Bronze Age, c1500–700 BC', in Chevillot & Coffyn (eds), 25–45.
- Burgess, C & O'Connor, B 2004 'Bronze Age rotary spits: finds old and new, some false, some true', in Roche et al (eds), 184–99.
- Burgess, C, Topping, P & Lynch, F (ed) 2007 *Beyond Stonehenge. Essays on the Bronze Age in Honour of Colin Burgess*. Oxford: Oxbow Books.
- Charnier, J F, Briard, J, Bouvet, J P, Bourhis, J R & Poulain, H 1999 'Le dépôt de Saint-Léonard-des-Bois, «Grand Champ du Veau d'Or» (Sarthe). Un nouveau témoignage des relations atlantique/continent au Bronze final', *Bulletin de la Société Préhistorique Française* 96/4, 569–79.
- Charpy, J J 1995 'The late Hallstatt burial at Saint-Lumier-La-Populeuse (Marne) and the problem of Jogassian daggers', in Raftery, B, Megaw, V & Rigby, V (eds) *Sites and Sights of the Iron Age. Essays on Fieldwork and Museum Research presented to Ian Mathieson Stead*, 13–30. Oxford: Oxbow Books.
- Chevillot, C 1989 *Sites et cultures de l'âge du Bronze en Périgord*. Périgueux: Vesuna.
- Chevillot, C & Coffyn, A (eds) 1991 *L'âge du Bronze atlantique, ses faciès, de l'Ecosse à l'Andalousie et leurs relations avec le Bronze continental et la Méditerranée. Actes du 1er colloque de Beynac, 10–14 sept. 1990*. Beynac: Association des Musées du Sarladais.
- Chevillot, C & Gomez, J 1979 'Roues de char et statuettes en terre cuite de Chalucet (Saint-Jean-Ligoure, Haute-Vienne). Leur signification culturelle', *Bulletin de la Société Préhistorique Française* 76/10–12, 434–44.
- Clausing, C 2002 'Geschmürte Beinschienen der späten Bronze- und älteren Eisenzeit', *Jahrbuch des Römisch-Germanischen Zentralmuseums*, Mainz 49, 149–87.
- Coffyn, A 1985 *Le bronze final atlantique dans la péninsule ibérique*. Paris: De Boccard.
- Coffyn, A, Gomez, J & Mohen J P 1981 *L'apogée du Bronze atlantique: le dépôt de Vénat*. Paris: Picard (=du Bronze en France 1).

SCOTLAND IN LATER PREHISTORIC EUROPE

- Coles, J 1960 'Scottish Late Bronze Age metalwork: typology, distributions and chronology', *Proceedings of the Society of Antiquaries of Scotland* 93 (1959–60), 16–134.
- Colquhoun, I A 1979 'The Late Bronze Age hoard from Blackmoor, Hampshire', in Burgess, C B & Coombs, D (eds) *Bronze Age Hoards. Some Finds Old and New*, 99–115. Oxford: British Archaeological Reports (=British Series 67).
- Coombs, D 1992 'Flag Fen platform and Fengate Power Station post alignment – the metalwork', *Antiquity* 66, 504–17.
- Cordier, G 1996 *Le dépôt de l'âge du Bronze final du Petit-Villatte à Neuvy-sur-Barangeon (Cher) et son contexte régional*. Joué-lès-Tours: G Cordier.
- Cowie, T, O'Connor, B & Proudfoot, E 1991 'A Late Bronze Age hoard from St Andrews, Fife, Scotland: a preliminary report', in Chevillot & Coffyn (eds), 49–58.
- Cowie, T, Hall, M, O'Connor, B & Tipping, R 1996 'The Late Bronze Age hoard from Corrymuckloch, near Amulree, Perthshire: an interim report', *Tayside & Fife Archaeological Journal* 2, 60–9.
- David-Elbiali, M 2000 *La Suisse occidentale au IIe millénaire av J-C*. Lausanne: Cahiers d'archéologie romande (no 80).
- Déchelette, J 1910 *Manuel d'archéologie préhistorique, celtique et gallo-romaine. II Archéologie celtique ou protohistorique. Première partie: âge du Bronze*. Paris: Picard.
- Dechezleprêtre, T & Ginoux, N 2005 'Les constructions circulaires de la moitié nord de la France: état de la question', in Buchsenschutz, O & Mordant, C (eds) *Architectures protohistoriques en Europe occidentale du Néolithique final à l'âge du Fer. Actes du 127^e congrès du CTHS, 15–20 avril 2002, Nancy*, 77–87. Paris: Editions du Comité des Travaux Historiques et Scientifiques.
- Delibes de Castro, G, Fernandez Manzano J & Fontaneda Pérez Rovira Llorens, S 1999 *Metalurgia de la Edad del Bronce en el piedemonte meridional de la Cordillera Cantábrica. La Colección Fontaneda*. León: Junta de Castilla y León (=Arqueología en Castilla y León, Monografías 3).
- Fily, M 2004 'Le Bronze final I en Bretagne: le site à dépôts de Saint-Ygeaux dans les Côtes-d'Armor (Bretagne). Opérations réalisées en 2002', *Bulletin de l'Association pour la Promotion des Recherches sur l'Âge du Bronze* 1, 4–5.
- Fischer, U 1979 *Ein Grabhügel der Bronze- und Eisenzeit im Frankfurter Stadtwald*. Frankfurt: Waldmar Kramer (=Frankfurter Museums für Vor- und Frühgeschichte Schriften IV).
- Flouest, J L & Stead, I M 1981 *Iron Age Cemeteries in Champagne. The Third Interim Report*. London: British Museum (=Occasional Paper 6).
- Gaucher, G & Robert, Y 1967 'Les dépôts de bronze de Cannes-Ecluse (Seine-et-Marne)', *Gallia Préhistoire* 10/1, 169–224.
- Gerloff, S 1981 'Westeuropäische Griffzungenschwerter in Berlin. Zu Chronologischen Problemen der britischen Spätbronzezeit', *Acta Praehistorica Archaeologia* 11/12, 183–217.
- Gerloff, S 1986 'Bronze Age class A cauldrons: typology, origins and chronology', *Journal of the Royal Society of Antiquaries of Ireland* 116, 84–115.
- Gerloff, S 2004 'Hallstatt fascination: "Hallstatt" buckets, swords and chapes from Britain and Ireland', in Roche et al (eds), 124–54.
- Gerloff, S 2007 'Reinecke's ABC and the chronology of the British Bronze Age', in Burgess et al (eds), 117–61.
- Gerloff, S 2010 *Atlantic Cauldrons and Buckets of the Late Bronze Age and Early Iron Ages in Western Europe*. Stuttgart: Franz Steiner Verlag (=Prähistorische Bronzefunde II.18).
- Giot, P-R 1963 'Ouverture du Colloque Atlantique', *Les civilisations atlantiques du Néolithique à l'âge du Fer (Actes du 1er Colloque Atlantique, Brest 1961)*, 3–4. Rennes: Laboratoire d'Anthropologie Préhistorique de la Faculté des Sciences de Rennes.
- Gomez de Soto, J 1984 'Chars funéraires, chars rituels ou chars de combat? De la nature du pouvoir dans les sociétés du Bronze Final en France et dans l'aire de la culture des Champs-d'urnes d'Allemagne du Sud et d'Europe centrale', *Éléments de pré et protohistoire européenne. Hommages à Jacques-Pierre Millotte*, 605–15. Paris: Université de Besançon (=Annales Littéraires de l'Université de Besançon, 299, Série archéologique 32).
- Hatt, J J & Roualet, P 1976 'Le cimetière des Jogasses en Champagne et les origines de la civilisation de La Tène', *Revue Archéologique de l'Est* 27, 421–48.
- Hencken, H 1971 *The Earliest European Helmets. Bronze Age and Early Iron Age*. Cambridge (Massachusetts): Harvard University, Peabody Museum of Archaeology and Ethnology (=American School of Prehistoric Research 28).
- Henderson, J C 2007 *The Atlantic Iron Age. Settlement and Identity in the First Millennium BC*. London: Routledge.
- Jockenhövel, A 1971 *Die Rasiermesser in Mitteleuropa (Süddeutschland, Tschechoslowakei, Österreich, Schweiz)*. München: C H Beck (=Prähistorische Bronzefunde VIII, 1).
- Jockenhövel, A 1980 *Die Rasiermesser in Westeuropa*. München: C H Beck (=Prähistorische Bronzefunde VIII, 3).
- Jockenhövel, A & Smolla, G 1975 'Le dépôt de Juvincourt-Damary (Aisne)', *Gallia Préhistoire* 18/2, 289–313.
- Kerouanton, I 2002 'Le lac du Bourget (Savoie) à l'âge du Bronze final: les groupes culturels et la question du groupe du Bourget', *Bulletin de la Société Préhistorique Française* 99/3, 521–61.
- Kossack, G 1959 *Südbayern während der Hallstattzeit*. Berlin: W De Gruyter.
- Kossack, G 1970 *Gräberfelder der Hallstattzeit an Main und Fränkischer Saale*. Kallmünz: M Lassleben (=Materialhefte zur Bayerischen Vorgeschichte 24).
- Kromer, K 1959 *Das Gräberfeld von Hallstatt*. Florence: Sansoni.

BRONZE OBJECTS FOR ATLANTIC ELITES IN FRANCE AND BEYOND

- Landolt, M 2005 'La nécropole hallstattienne de Chaillon (Meuse)', *Bulletin de l'Association Française pour l'Étude de l'Âge du Fer* 23, 41–3.
- Milcent, P-Y 1997 'De l'âge du Bronze à l'âge du Fer', *Princes et paysans de l'âge du Bronze en Berry*, 77–80. Saint Marcel: Musée d'Argentomagus.
- Milcent, P-Y 1998 *Recherches sur le premier âge du Fer en France centrale*. Thèse de doctorat, Université de Paris I – Panthéon-Sorbonne, Préhistoire-Anthropologie-Ethnologie.
- Milcent, P-Y 2004 *Le premier âge du Fer en France centrale*. Paris: Société Préhistorique Française (= Mémoire 34).
- Milcent, P-Y 2006 'Premier âge du Fer médio-atlantique et genèse multipolaire des cultures matérielles laténiennes', in Vitali, D (ed) *Celtes et Gaulois, l'archéologie face à l'histoire, 2: la préhistoire des Celtes. Actes de la table ronde de Bologne-Monterenzio, 28–29 mai 2005*, 81–105. Glux-en-Glenne: Bibracte.
- Milcent, P-Y 2009 'A l'est rien de nouveau. Chronologie des armes de poing du premier âge du Fer médio-atlantique et genèse des standards matériels élitaires hallstattiens et laténiens', in Lehoërf, A (ed) *Construire le temps. Histoire et méthodes des chronologies et calendriers des derniers millénaires avant notre ère en Europe occidentale. Actes du XXXe colloque international de Halma-Ipel, UMR 8164, 7–9 décembre 2006*, Lille, 137–56. Glux-en-Glenne: Bibracte.
- Milcent, P-Y 2010 *Le temps des élites en Gaule atlantique (XIIIe–VIIe s. av. J.-C.)*. Mémoire de recherche d'Habilitation à Diriger des Recherches, Ecole Pratique des Hautes Etudes.
- Milcent, P-Y 2012 *Le temps des élites en Gaule atlantique. Chronologie des mobiliers et rythmes de constitution des dépôts métalliques dans le contexte européen (XIIIe–VIIe s. av. J.-C.)*. Rennes: Presses Universitaires de Rennes.
- Milcent, P-Y (ed) forthcoming *Le 1er âge du Fer atlantique en Gaule. Actes du colloque tenu à Boulogne en octobre 2012*.
- Milcent, P-Y & Leroy, D 2003 'Le dépôt à éléments de char du Bronze final d'Onzain (Loir-et-Cher, Centre, France): présentation préliminaire', *Jahrbuch des Römisch-Germanischen Zentralmuseums Mainz* 50, 207–30.
- Mohen, J P 1977 *L'Age du Bronze dans la région de Paris*. Paris: Musées Nationaux.
- Needham, S P 1979 'Two recent British shield finds and their Continental parallels', *Proceedings of the Prehistoric Society* 45, 111–34.
- Needham, S P 1996 'Chronology and periodisation in the British Bronze Age', in Randsborg, K (ed) *Absolute Chronology. Archaeological Europe 2500–500 BC*, 121–40. Munksgaard: Acta Archaeologica (Supplementa 1).
- Needham, S P, Bronk Ramsey, C, Coombs, D, Cartwright, C & Petit, P 1997 'An independent chronology for British Bronze Age metalwork: the results of the Oxford radiocarbon accelerator programme', *Archaeological Journal* 154, 55–107.
- O'Connor, B 1980 *Cross-Channel Relations in the Later Bronze Age. Relations between Britain, North-Eastern France and the Low Countries during the Later Bronze Age and the Early Iron Age, with Particular Reference to the Metalwork*. Oxford: British Archaeological Reports (= International Series 91).
- O'Connor, B 2007 'Llyn Fawr metalwork in Britain: a review', in Haselgrove, C & Pope, R (eds) *The Earlier Iron Age in Britain and the Near Continent*, 64–79. Oxford: Oxbow Books.
- Pare, C F E 1991 *Swords, Wagon-graves, and the Beginning of the Early Iron Age in Central Europe*. Marburg: Vorgeschichtlichen Seminar der Philipps-Universität Marburg (= Kleine Schriften 37).
- Pare, C F E 1992 *Wagons and Wagons-Graves of the Early Iron Age in Central Europe*. Oxford: Oxford University Committee for Archaeology.
- Pare, C F E 1998 'Beiträge zum Übergang von der Bronze zur Eisenzeit in Mitteleuropa. Teil I: Grundzüge der Chronologie im östlichen Mitteleuropa (11.–8. Jahrhundert v Chr)', *Jahrbuch des Römisch-Germanischen Zentralmuseums Mainz* 45, 293–433.
- Pare, C F E 1999 'Beiträge zum Übergang von der Bronze zur Eisenzeit in Mitteleuropa. Teil II: Grundzüge der Chronologie im westlichen Mitteleuropa (11.–8. Jahrhundert v. Chr.)', *Jahrbuch des Römisch-Germanischen Zentralmuseums Mainz* 46, 175–315.
- Pare, C F E 2004 'Die Wagen der Bronzezeit in Mitteleuropa', in Burmeister, S & Fansa, M (eds) *Rad und Wagen. Der Ursprung einer Innovation Wagen im Vorderen Orient und Europa*, 355–72. Mainz: Philipp von Zabern (= Beiheft der Archäologische Mitteilungen aus Nordwestdeutschland 40).
- Pautreau, J P, Gendron, C & Bourhis, J R 1984 *L'Age du Bronze en Deux-Sèvres (2500–800 avant J-C). La cachette de Triou. Niort: Musée de Niort*.
- Peake, R, Seguié, J M & Gomez de Soto, J 1999 'Trois exemples de fléaux de balances en os de l'âge du Bronze', *Bulletin de la Société Préhistorique Française* 96/4, 643–4.
- Piggott, S 1953 'A Late Bronze Age hoard from Peeblesshire', *Proceedings of the Society of Antiquaries of Scotland* 87 (1952–3), 175–86.
- Roche, H, Grogan, E, Bradley, J, Coles, J & Raftery, B (eds) 2004 *From Megaliths to Metal. Essays in Honour of George Eogan*. Oxford: Oxbow Books.
- Schauer, P 2003 'Zur Zeitstellung der vermeintlich ältesten Bronzekammhelme in Mitteleuropa', *Archäologisches Korrespondenzblatt* 33, 193–203.
- Silva, A C F da 1986 *A cultura castreja no Noroeste de Portugal. Paços de Ferreira: Museu da Citania de Sanfins/Câmara Municipal de Paços de Ferreira*.
- Toupet, C 1983 'Mode et rite funéraires de la nécropole Hallstatt B/C de Longuesse (Val-d'Oise). Groupe de Longuesse – contexte européen', *Endos funéraires et structures d'habitat en Europe du Nord-Ouest. Actes de la Table ronde CNRS-Université de Rennes I, 24–27 septembre 1981, Rennes*, 243–61. Rennes: Laboratoire d'Anthropologie.

SCOTLAND IN LATER PREHISTORIC EUROPE

Verron, G 1971 *Antiquités préhistoriques et protohistoriques*. Rouen: Musée Départemental des Antiquités de la Seine-Maritime.

Warmenbol, E 2001 'Bronze Age miniatures – a small contribution', in Metz, W H, Van Beek, B L & Steegstra, H

(eds) *Patina. Essays Presented to Jay Jordan Butler on the Occasion of his 80th Birthday*, 610–19. Groningen/Amsterdam: privately published.

Zürn, H 1987 *Hallstattzeitliche Grabfunde in Württemberg und Hohenzollern*. Stuttgart: Theiss.