



**HAL**  
open science

## Hausdorff distance: A new target localization using single hydrophone

Pedro Martins de Magalhães, Xavier Cristol, Cornel Ioana, Jerome I. Mars

### ► To cite this version:

Pedro Martins de Magalhães, Xavier Cristol, Cornel Ioana, Jerome I. Mars. Hausdorff distance: A new target localization using single hydrophone. GRETSI 2017 - XXVIème Colloque francophone de traitement du signal et des images, Sep 2017, Juan-Les-Pins, France. hal-01965621

**HAL Id: hal-01965621**

**<https://hal.science/hal-01965621v1>**

Submitted on 26 Dec 2018

**HAL** is a multi-disciplinary open access archive for the deposit and dissemination of scientific research documents, whether they are published or not. The documents may come from teaching and research institutions in France or abroad, or from public or private research centers.

L'archive ouverte pluridisciplinaire **HAL**, est destinée au dépôt et à la diffusion de documents scientifiques de niveau recherche, publiés ou non, émanant des établissements d'enseignement et de recherche français ou étrangers, des laboratoires publics ou privés.

# Hausdorff distance: A new target localization using single hydrophone.

PEDRO MAGALHÃES<sup>1,2</sup>, XAVIER CRISTOL<sup>1</sup>, CORNEL IOANA<sup>2</sup>, JEROME MARS<sup>2</sup>

1 : Thales Underwater Systems, 525 route des Dolines BP 157 , 06903 Sophia Antipolis, France

2 : Université Grenoble-Alpes, CNRS, Grenoble-INP, GIPSA-lab, F-38000 Grenoble, France

pedro-eugenio.martins-de-magalhaes@fr.thalesgroup.com, xavier.cristol@fr.thalesgroup.com, cornel.ioana@gipsa-lab.fr,  
jerome.mars@gipsa-lab.fr

**Résumé** - Cet article traite du problème de la localisation de source avec un seul capteur en acoustique sous marine. Une nouvelle mesure de distance appelée Hausdorff Distance (HD) est introduite pour comparer différents ensemble de TDOA (Time difference of Arrival) simulés (TDOAs) aux TDOA reçus (TDOAr). Cette méthode utilisée en traitement d'image pour mesurer le degré de similitude entre deux objets est adaptée et appliquée ici dans un contexte complètement nouveau. Deux extensions (la distance maximum de Hausdorff et la distance médiane de Hausdorff) sont présentées sur un cas réel pour trouver la position correcte, (en portée et en profondeur) d'une cible. Les résultats en termes de localisation, de précision sont montrés dans une expérience réelle en cuve.

**Abstract:** This paper addresses the problem of source localization with only one sensor. A new metric called Hausdorff Distance (HD) for an optimal matching, is used for TDOAs best matching between simulations (TDOAs) and real data (TDOAr). To obtain the simulated impulse response, we drive an acoustic ray path propagation method. So we compare these simulated data with TDOA estimated after matched filtering considering a known transmitted signal. Two derivated techniques from HD are presented to find correct position, in range and depth, 1) the Maximum Hausdorff distance and 2) the Median Hausdorff distance. Results in terms of the localization, accuracy are shown in a real tank experiment.

## 1 Introduction

In this paper, we investigate the problem of underwater source detection (target localization) and 2D localization, in range and deep, using a matching technique based on a new metric called Hausdorff Distance. Localization of acoustic sources is classically done by measurement of the time difference of arrival (TDOA) [1]. Nowadays several solutions exist, based on cross correlation processing [2], Bartlett estimator [3] as well as modal propagation.

The new metric Hausdorff Distance was very briefly used recently (2016) in underwater domain by Mours et al. [4]. In our work, we show that, with only one sensor, it is possible to detect and give position based on TDOA analysis. In order to obtain these TDOA, we first estimate the time delay from cross correlation between received signal and transmitted signal, and; then, by finding the best match between real data and simulated data, it is possible to give target position in range and deep.

The second section gives a basic understanding of underwater propagation in order to express the context (Ray path propagation). In Sec. 3, we present the experimental facility (tank) developed at GIPSA-LAB, and we explain how the experimental data have been recorded to search the target position. In Sec. 4, we will provide the description of Hausdorff Distance Technique and its extensions and the way it can be used for localization purpose. Finally in Sec. 5 we show the experiments results and the conclusion.

## 2 Underwater Propagation

Firstly, it is necessary to express the underwater propagation. Classically, propagation models can be classified into two groups [5]:

First one is Range dependent model, where variation of environmental parameters (speed of sound and bathymetry) is considered not only as a function of depth, but also in terms of the range and azimuth,

Second one is Range independent model, where horizontal stratification of the oceans is assumed, and then variation of environmental parameters is only a function of depth. In these geometries, because only one propagation path is considered, called one-way, there is no oceanographic characteristics that cause the way back (incoming wave) and therefore the solution is based only on the divergent wave (outgoing wave).

In this work, we ignore the way back (incoming wave) and we consider a range independent propagation because the variation of environmental parameters are disregarded.

### 2.1 Ray propagation

Now, we must define briefly the Raypath propagation model. Since early 1960s, it is used commonly for high frequencies and deep water, because it is only valid if the magnitude distances order involved are much greater than the wavelength [6]. The ray propagation theory is

mainly described in [7]. Figure 1 shows the variation of the Munk's sound speed profile for small variations of the ray's curvature, according to Snell's law. The received signal is composed of several arrivals that are time shifted and attenuated versions of the emitted signal. In this case, we will consider three different groups only, which differ by the reflection number at the bottom (figure 2). The limit to 3 is due to high attenuation caused by those reflections at the bottom principally. On the first group - zero bottom reflection, second group - one bottom reflection and third group - two bottom reflections.

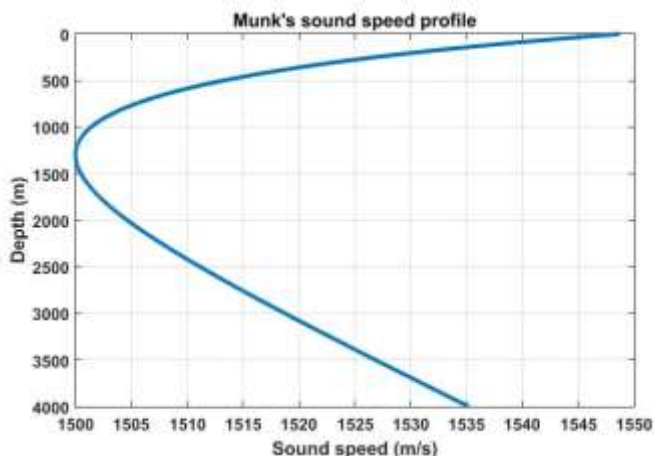

Figure 1 - Munk's sound speed profile

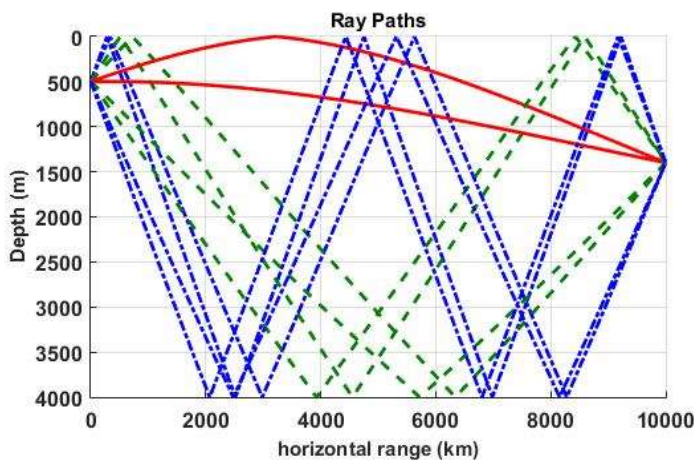

Figure 2 Composition of the 3 groups, which differ by the reflection number at the bottom.

For the first simulation (a 13 km range), it can be shown in the figure 3, a total of 10 multipaths : 2 for the first group (red color at 1 km range), 4 for the second (green color at 1 km range) and 4 for the third group (blue color at 1 km range). After 1km, only 8 multipaths are still presented due to the fact that the direct path does not appear anymore due to the ray curvature. It can be noted that, each variation in distance results in different TDOA, and the latter reduces with increasing distance. Another conclusion is that, for distance localization, the TDOA intergroup information are more significant, (being the reason whereby they have been used for localization in range). After this presentation, we give the objective of this paper: the TDOA of the received signal is compared

with the set of simulated one via the Hausdorff Distance and through this process, we can identify the distance of the target (range and depth) with only one sensor.

For the second simulation, the figure 4 shows the total of 10 multipaths for all depths, 2 for the first group (red color at 1 km range), 4 for the second (light blue color at 1 km range) and third (dark blue color at 1 km range) group each. It can be noted that with increasing depth the TDOA intragroup become more significant due to the dispersion, being TDOA intragroup the reason whereby they have been used for depth localization.

The table 1 shows how the simulations were done and which parameters have considered for each case.

Table 1 – Set of simulations.

	First Simulation	Second Simulation
Type	Arrival time with distance variation	Arrival time with depth variation
Focus	estimate the distance	estimate the depth
TX depth	500 m	500 m
RX depth	1700 m	100-3500 m
Distance	1-35 km	2 km
Bottom	flat at 4000 m	flat at 4000 m

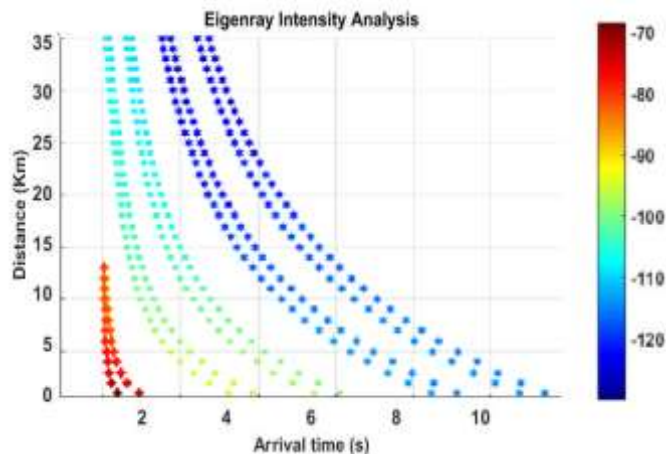

Figure 3 – Arrival time with distance variation.

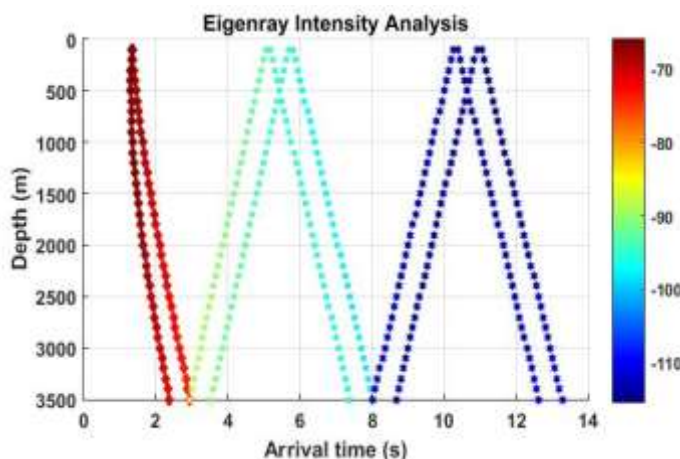

Figure 4 - Arrival time with depth variation.

### 3 Experiment in the Tank (GIPSA-LAB)

To prove and give information on this new localization technique, a set of experiments have been conducted in the experimental facility of GIPSA-LAB at University of Grenoble Alpes. It is composed by a water tank whose size is 1.5 meters length by 1 meter width by 1 meter height, (shown in Figure 5 - 6). In our experiment, the signal was sampled at 25MHz with a resolution of 16 bits, and we considered the medium as homogeneous, used for approximation of the linear wave equation. The Doppler effect has not been considered. The sensors, either the transmitter, Tx, and the receiver, Rx, shown at "Fig 1", have 7 degrees' beam spread at 1MHz for 0.5-inch diameter. This allows us to disregard the tank's side considering a narrow beam spread.

The assembled system was static with 3 different distances, and same depths. We chose fixed distance and depth in order to show the localization results.

For the transmission, the sensor was located at 0.1 m deep. For the reception, the sensor was located at 0.3 m deep and 0.7 m range, centered horizontally in the tank (figure 5).

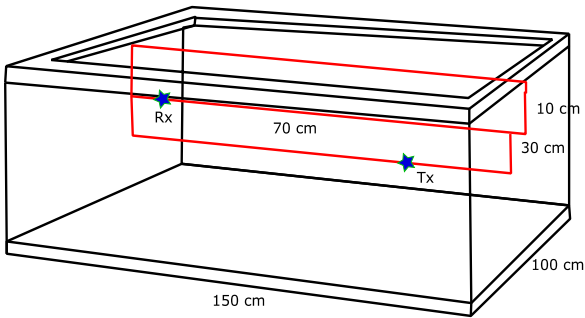

Figure 5 – Measurement setup.

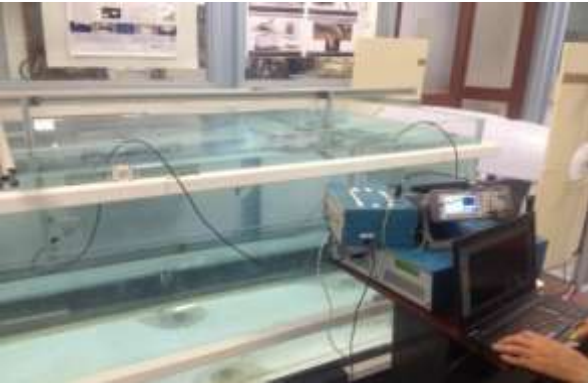

Figure 6 – Experimental facility.

The table 2 expresses the signal transmitted in this experiment. We were interested to obtain the impulse response from the channel.

Table 2 – Transmitted signal.

Transmitted signal		
type	Time (s)	Frequency (Hz)
Chirp	100μs	500KHz-1.5MHz

### 4 Hausdorff Distance Technique

#### 4.1 Maximum Hausdorff Distance

As expressed, the comparison of TDOA was done by using the Hausdorff distance (HD), proposed by Huttenlocher [8]. This technique is quiet popular in image processing to measure the degree of similarity among different objects, giving an interesting measure of their mutual proximity. Our merit is to prove that matching technique performed through the minimization of the algorithm between two sets of point is efficient in underwater source localization.

Let consider two sets of points, first being the received TDOA  $R_T = \{r_1, r_2, r_3, \dots, r_x\}$ , second the simulated TDOA  $S_T = \{s_1, s_2, s_3, \dots, s_y\}$ , the Maximum Hausdorff distance between them is defined as:

$$H(R_T, S_T) = \max \{h(R_T, S_T), h(S_T, R_T)\} \quad (1)$$

where:

$$h(R_T, S_T) = \max_{r \in R} [\min(\|r_i - s\|)] \quad i = \{1, 2, 3, \dots, x\} \quad (2)$$

$$h(S_T, R_T) = \max_{s \in S} [\min(\|s_j - r\|)] \quad j = \{1, 2, 3, \dots, y\} \quad (3)$$

Maximum Hausdorff Distance is small when every point in one of the sets is near to some point in the other. The Euclidean distance function was used to evaluate the norm  $\| \cdot \|$ , and selects the farthest which is the largest discrepancy between the two sets of points or maximal distance.

#### 4.2 Mean Hausdorff Distance

An extended version of the technique was done by Dubuisson, in 1994, called Modified Hausdorff Distance (MHD) with the Mean Hausdorff Distance [9]. The main difference is that, all points contribute to measure the average of the distance, which ensures that more measurement points closely resemble the model. In other words this can soften the problems with false alarm or fake point at the received. MHD is given by:

$$\bar{h}(R_T, S_T) = \frac{1}{X} \sum_{i=1}^X [\min_{r \in R} (\|r_i - s\|)] \quad i = \{1, 2, 3, \dots, x\} \quad (4)$$

$$\bar{h}(S_T, R_T) = \frac{1}{Y} \sum_{j=1}^Y [\min_{s \in S} (\|s_j - r\|)] \quad j = \{1, 2, 3, \dots, y\} \quad (5)$$

### 5 Results and Conclusion

In our experimental case, the final received signal is the combination of different signals with different take-off angle for each ray path. This means that for each ray, we need to mechanically rotate the sensors and align with the correct angle in order to record the high energy of the transmitted signal, due to the high directivity of the sensor. The received package contains 9 different take off angles, shown at figure 7. The amplitude of the received signal for each ray was combined with the 2 amplifiers (TX and RX). The synchronization of the different

signals recorded, with different take off angles, was done by with transmitted signal.

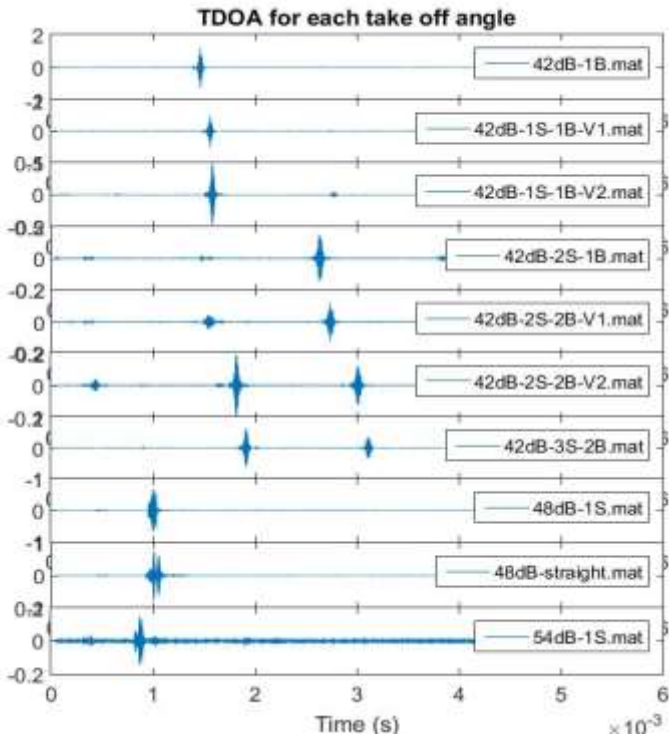

Figure 7 – TDOA recorded for 9 take off angles.

Once the signal for each ray is recorded, we estimate the TDOA for each path. We first apply the sum in time domain of the signal (figure 7) and after we cross-correlate it with the transmitted signal. The maximum local value for each ray is then estimated (figure 8). The arrival time for each ray (TDOAr) is compared with the TDOAs simulated using the ray path propagation simulator. We use the Hausdorff techniques to find the best matching in order to find the correct position. The signal noise ratio for this measurement is 23.69dB.

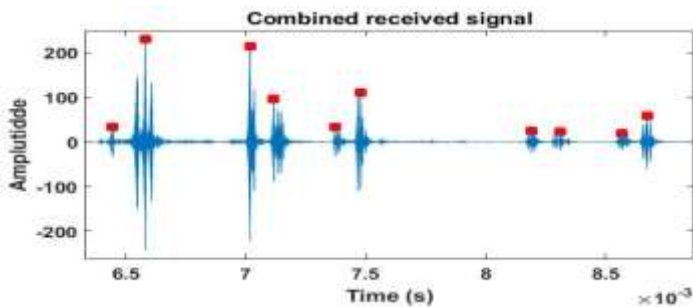

Figure 8 – Received signal from sum of different take off angles.

In order to validate the results, we present, in figure 9 and 10, the HD and MHD results (normalized and with the same color mapping in order to direct compare both images in term of accuracy). The dark blue value is the minimum value. It can be considered as the real position of the target. In both measurements, we can well locate the target (dark blue). In our experiment, we can also notice that the Mean Hausdorff Distance is more accurate, due to its small dark blue area, which is related to its variance of error, compared with the Maximum Hausdorff Distance. The target is located in the red line intersection, at 0.3 m deep and 0.7 m range.

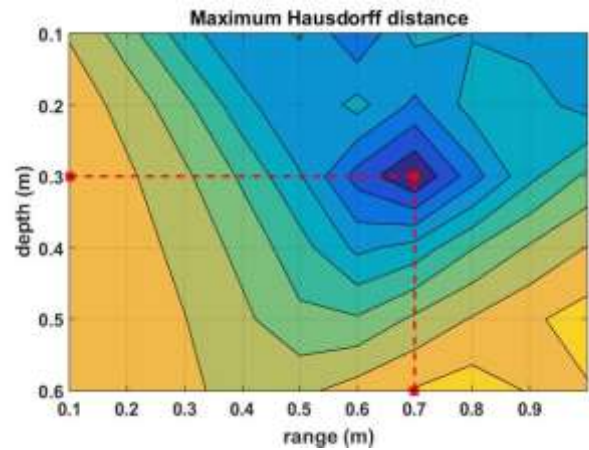

Figure 9 – Error of Maximum Hausdorff Distance

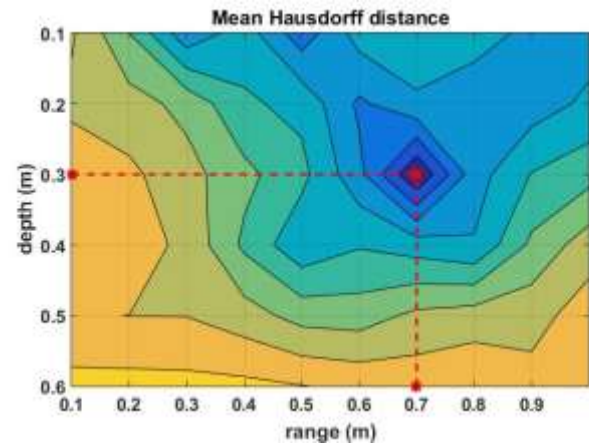

Figure 10 - Error of Median Hausdorff Distance.

To conclude, we prove on this work, that it is possible localize target, with a good precision, using a Hausdorff approach (Classical or Mean) with only one sensor at the receiver. Both techniques have shown to be very robust for underwater localization. The different experimental setup made in a tank proved that is possible to localize real signals with good accuracy.

#### REFERENCES

- [1] A. Sayed, A. TARIGHAT and N. KHAJEHNOURI, "Network-based wireless location: challenges faced in developing techniques for accurate wireless location information," *IEEE Signal Proc. Mag.*, pp. 24-40, 2005.
- [2] M. B. Porter, Y. Stephan, X. Demoulin, S. Jesus and E. Coelho, "Shallow-water tracking in the Sea of Nazare," in *Proceedings of 1998 Intern. Symp. on Underwater Technology*, Tokyo, 1998.
- [3] G. Le Touze, J. Torras, B. Nicolas and J. Mars, "Source localization on a single hydrophone," in *OCEANS 2008*, Quebec.
- [4] A. Mours, C. Ioana, J. Mars, N. Josso and Y. Doisy, "Target-depth estimation in active sonar: Cramer-Rao bounds for a bilinear sound-speed profile," *JASA*, 2016, Vol 140, 3, 1771-1782.
- [5] P. Etter, *Underwater Acoustic Modeling and Simulation*. 3th ed, New York: Spon Press, 2002.
- [6] L. Brekhovskikh, *Fundamentals of Ocean Acoustics*, 3th ed, New York: AIP PRESS, Springer, 2003.
- [7] J. Kuperman, M. B. Porter and H. Schmidt, *Computational Acoustics*, 2nd ed, New York: Springer, 2011.
- [8] D. Huttenlocher, G. Klanderman and W. Rucklidge, "Comparing images using the Hausdorff distance," *IEEE Trans. on Pattern Analysis and Machine Intelligence.*, pp. 850-863, 1993
- [9] M. Dubuisson and A. K. Jain, "A modified Hausdorff distance for object matching," in *Proceedings of 12th Inter. Conf. on Pattern Recognition*, Jerusalem, 1994.