



HAL
open science

On the use of a pulsed-laser source in laboratory seismic experiments

Chengyi Shen, Daniel Brito, Julien Diaz, Deyuan Zhang, Clarisse Bordes,
Florian Faucher, Stéphane Garambois

► **To cite this version:**

Chengyi Shen, Daniel Brito, Julien Diaz, Deyuan Zhang, Clarisse Bordes, et al.. On the use of a pulsed-laser source in laboratory seismic experiments. AGU meeting 2018, Dec 2018, Washington, United States. hal-01957147

HAL Id: hal-01957147

<https://hal.science/hal-01957147>

Submitted on 17 Dec 2018

HAL is a multi-disciplinary open access archive for the deposit and dissemination of scientific research documents, whether they are published or not. The documents may come from teaching and research institutions in France or abroad, or from public or private research centers.

L'archive ouverte pluridisciplinaire **HAL**, est destinée au dépôt et à la diffusion de documents scientifiques de niveau recherche, publiés ou non, émanant des établissements d'enseignement et de recherche français ou étrangers, des laboratoires publics ou privés.

On the use of a pulsed-laser source in laboratory seismic experiments

C. SHEN^{1,3}, D. BRITO^{1,3}, J. DIAZ^{2,3}, D. ZHANG¹, C. BORDES¹, F. FAUCHER^{2,3}, S. GARAMBOIS⁴

- 1) CNRS/ TOTAL / Univ Pau & Pays Adour/E2S UPPA, Laboratoire des Fluides Complexes et leurs Réservoirs – IPRA, UMR5150, 64000, Pau, FRANCE
- 2) Univ Pau & Pays Adour/CNRS, Laboratoire de Mathématiques et de leurs Applications, UMR5142, 64000, Pau, FRANCE
- 3) Project Team Magique-3D, Inria Bordeaux-Sud-Ouest, 64013 Pau, France
- 4) Univ. Grenoble Alpes, Univ. Savoie Mont Blanc, CNRS, IRD, IFSTTAR, ISTERre, UMR5275, 38000 Grenoble, France

Research context & objectives

Reproduction of large-scale seismic exploration at laboratory-scale with controllable sources is a promising approach that could not only be applied to study small-scale physical properties of the medium, but also contribute to significant progress in wave-propagation understanding and complex media imaging at exploration scale via upscaling methods. We seek to characterize the properties of a laser-generated seismic source for new geophysical experiments at laboratory scale. This consists in generating seismic waves by pulsed-laser impacts and measuring the displacement wavefield by laser vibrometry. Parallel 2D/3D simulations using Discontinuous Galerkin discretization method and analytic predictions have been done to match the experimental data.

Pulsed-laser source : General

Lab set-up for pulsed-laser source characterization

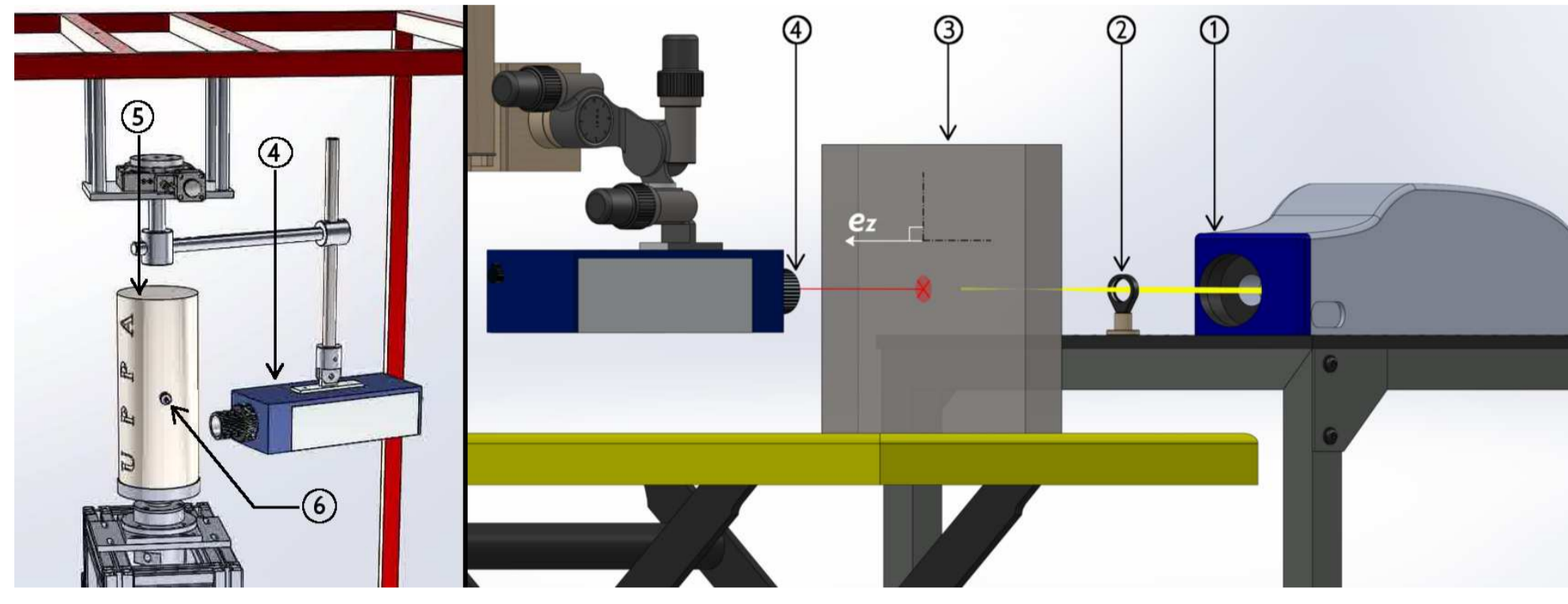

Two different experimental tools were mounted to investigate in Cartesian coordinates or in cylinder coordinates. ① : Q-Switched laser generator; ② : convergent lens; ③ : Aluminium cuboid samples of various thickness (10, 50, 100 mm), $V_p \approx 6350$ m/s, $V_s \approx V_p/2$; ④ : single point Laser Doppler Vibrometer (LDV); ⑤ : core sample; ⑥ : piezoelectric source.

Theoretical and analytical signals

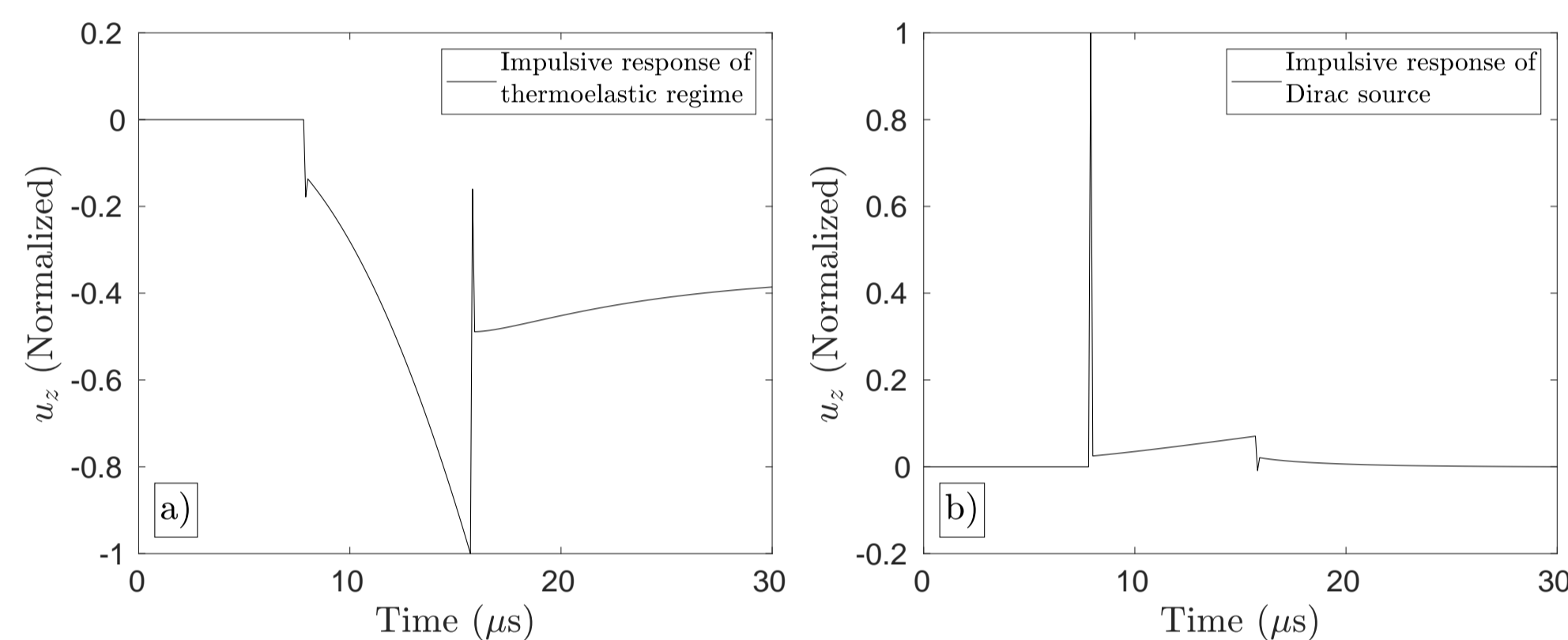

a) : laser-generated seismic source under thermoelastic regime with displacements computed by combining the wave equation and the thermoelastic equations [2, 3, 5]. b) : laser-generated seismic source under ablation regime which is modelled as a point-source [1, 2].

Zoom on the measured ablation-regime pulse

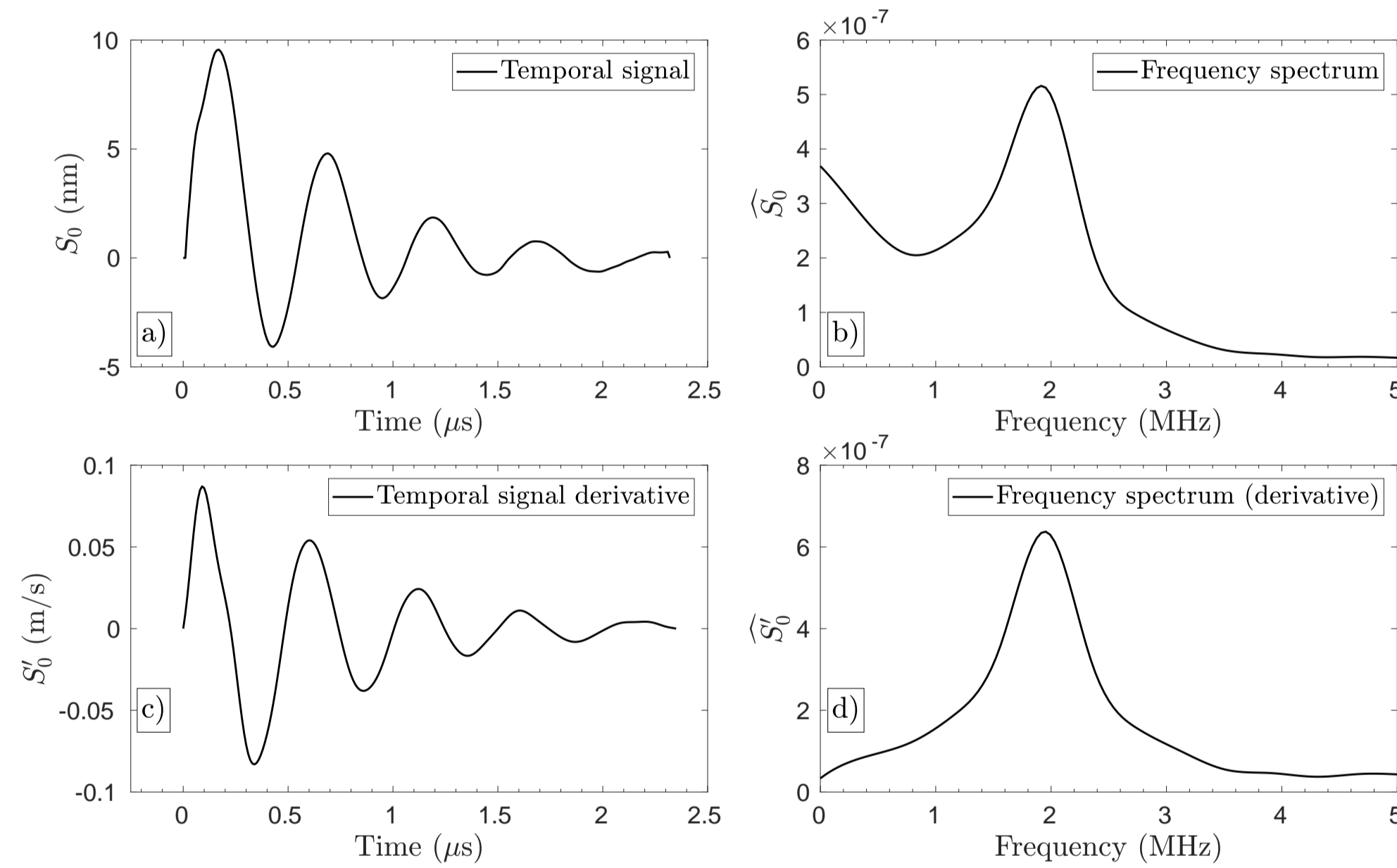

a) : Temporal laser-generated source S_0 retrieved from a record on the 50 mm thick aluminum block. b) : Frequency spectrum \tilde{S}_0 of the same source. c) First order derivative of S_0 , thus showing the surface vibration velocities. d) Frequency spectrum of S_0' .

Source stability and reproducibility

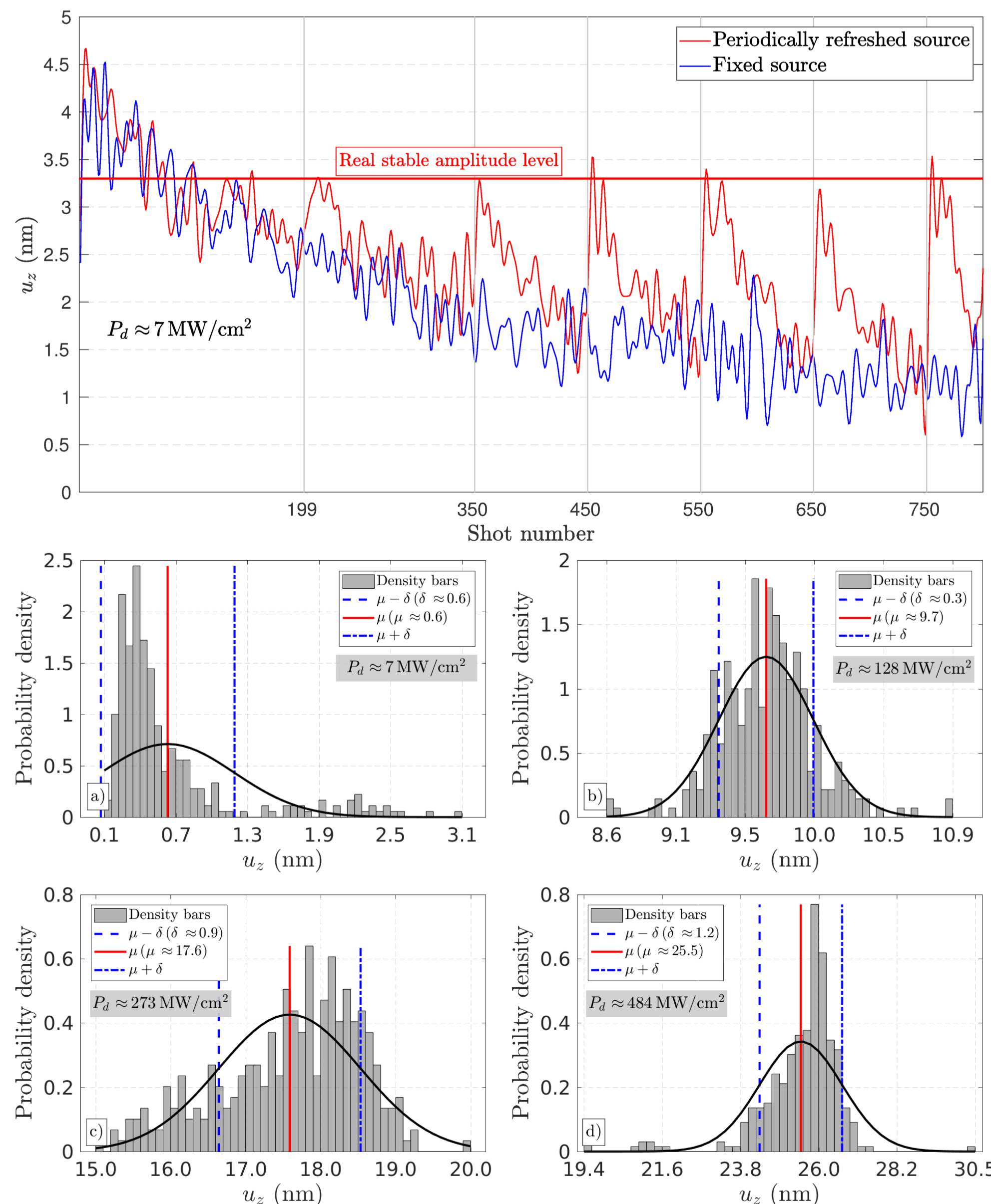

Distribution of first arrival seismic wave amplitudes u_z measured by LDV at the epicenter of the 10 mm thick aluminum block. P_d denotes the incident power density.

Pulsed-laser source : Seismogram

All regime

Two major parameters control the regime :

- 1) The incident energy;
- 2) The laser spot size

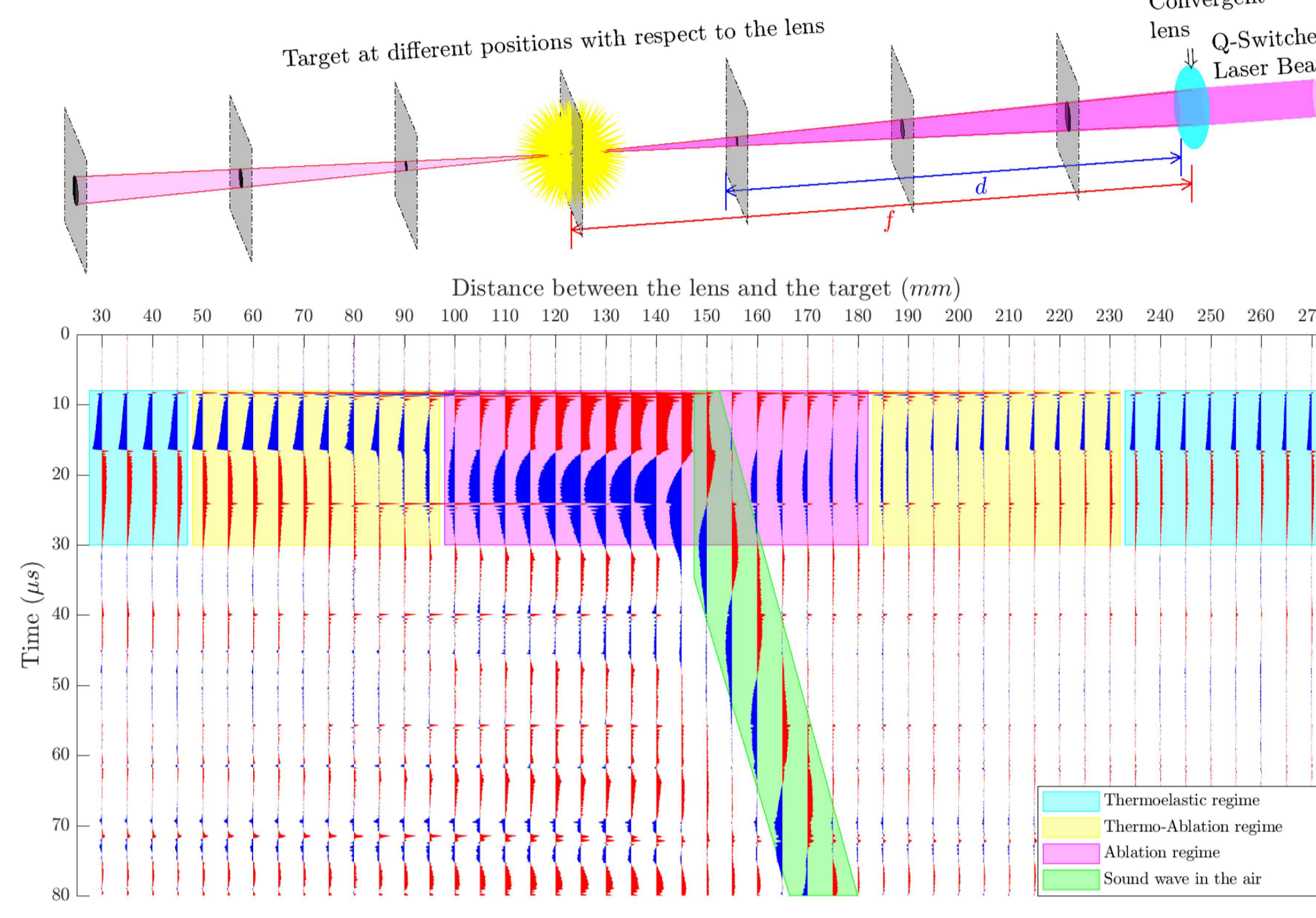

Regime evolution with d under constant input energy. Since the spot size depends on d , P_d varies. However, the observable regime cannot be determined unilaterally by P_d .

Seismogram and radiation patterns

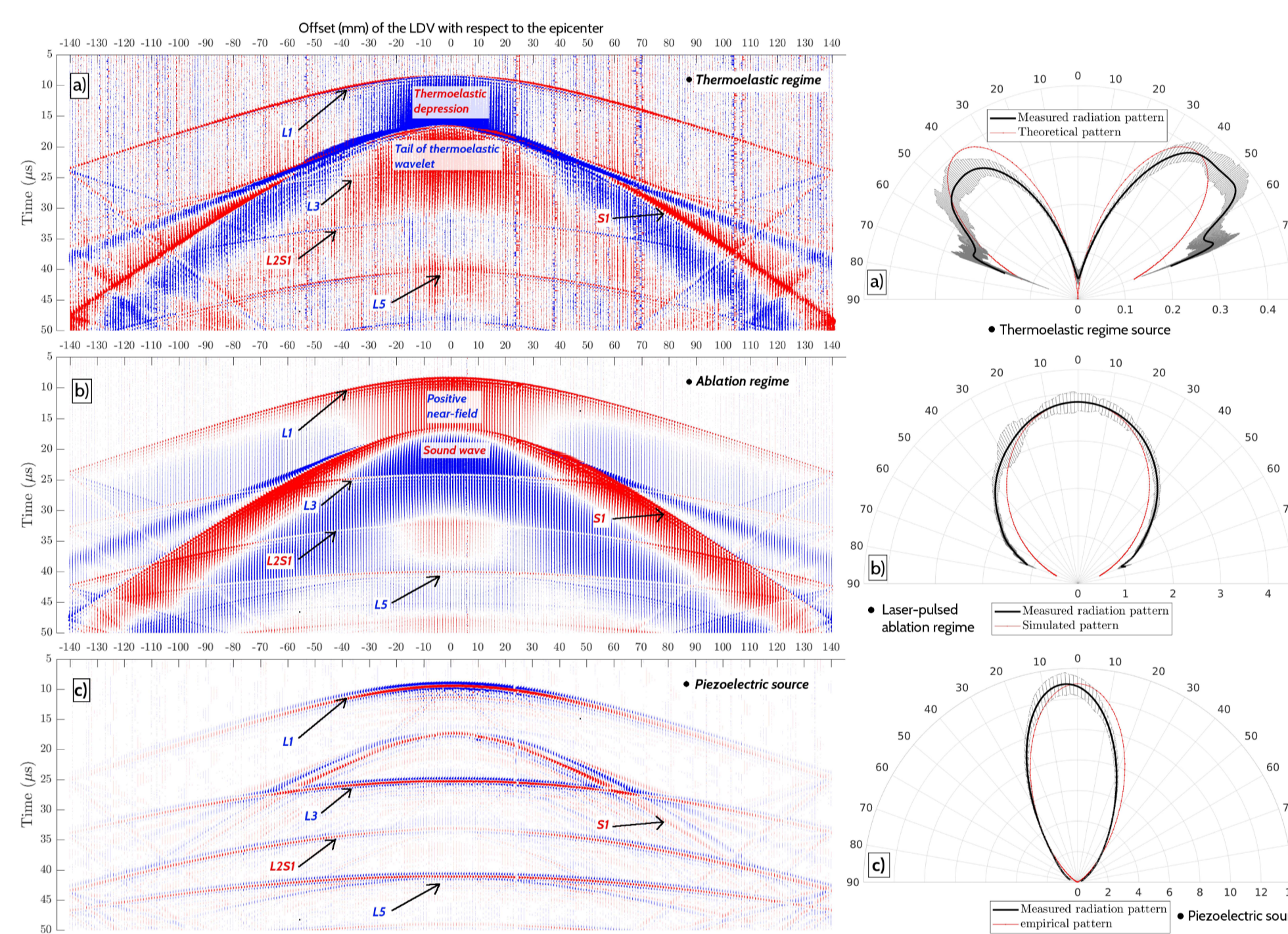

Seismogram measured along linear receivers on the 50 mm thick aluminum block with different sources, accompanied by simulated/modelled radiation patterns. a) : radiation pattern of a point source (laser ablation); b) : radiation pattern of a piezoelectric source ($\Phi \approx 10$ mm); c) : radiation pattern of a typical thermoelastic source [4] under laser irradiation.

Epicentral records under the ablation regime

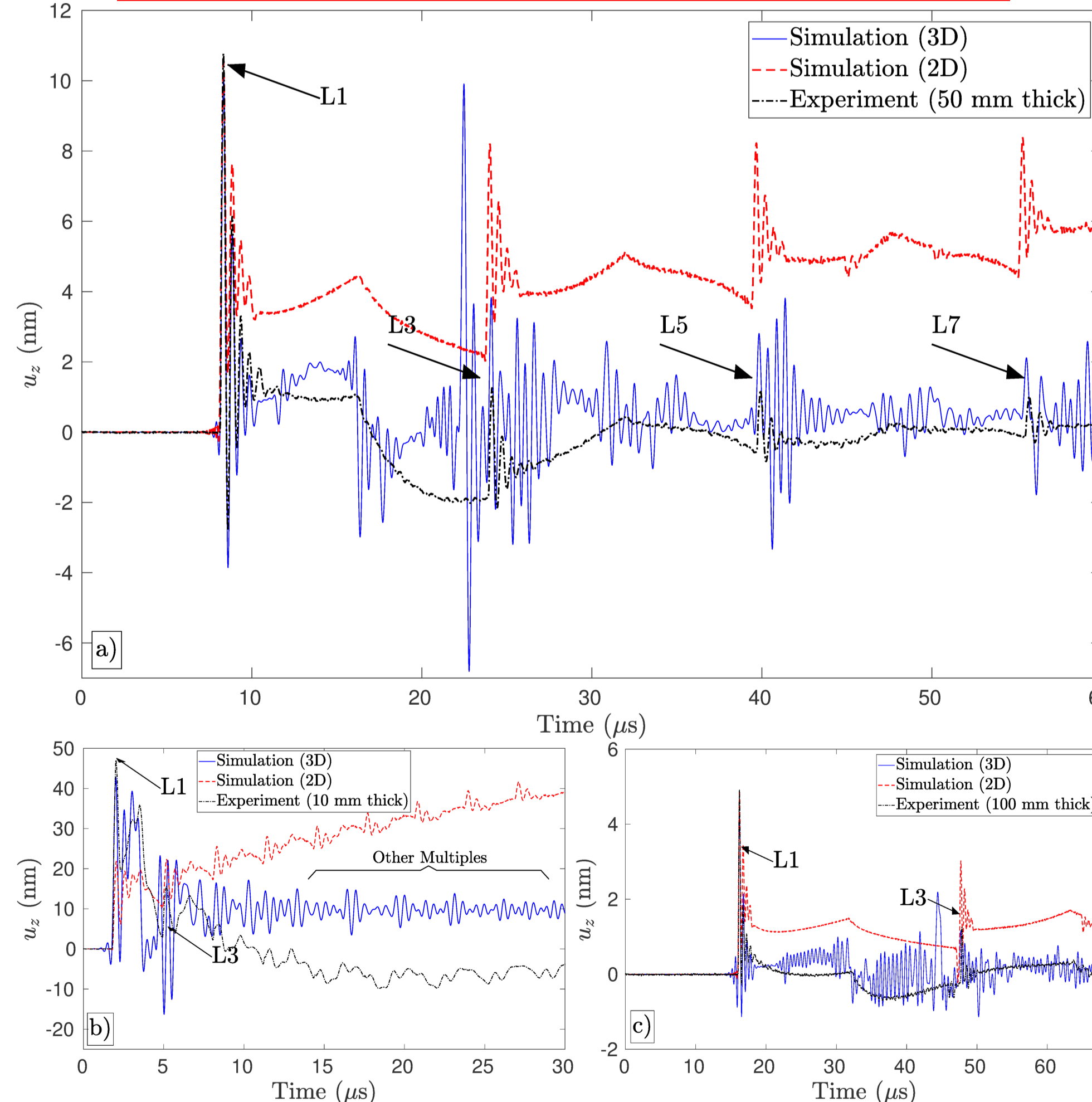

Overview on single experimental/simulated seismic traces (normal components). 2D/3D simulations are done by FE schemes featuring Discontinuous Galerkin (DG) with Interior Penalty (IP).

References

- [1] K. AKI AND P. G. RICHARDS, *Quantitative seismology*, 2002.
- [2] B. AUDON, C. BESCOND, AND M. DESCHAMPS, Measurement of stiffness coefficients of anisotropic materials from pointlike generation and detection of acoustic waves, *Journal of applied physics*, 80 (1996), pp. 3760–3771.
- [3] J. AUSSEL, A. LE EBRI, AND J. BABOUC, Generating acoustic waves by laser : theoretical and experimental study of the emission source, *Ultrasonics*, 26 (1988), pp. 245–255.
- [4] J. R. BERNSTEIN AND J. B. SPICER, Line source representation for laser-generated ultrasound in aluminum, *The Journal of the Acoustical Society of America*, 107 (2000), pp. 1352–1357.
- [5] R. DEWURST, D. HUTCHINS, S. PALMER, AND C. SCRUBY, Quantitative measurements of laser-generated acoustic waveforms, *Journal of Applied Physics*, 53 (1982), pp. 4064–4071.
- [6] B. DUPUY, S. GARAMBOIS, A. ASNAASHARI, H. M. BALHARETH, M. LANDRO, A. STOVAS, AND J. VIRIEUX, Estimation of rock physics properties from seismic attributes part 2 : Applications, *Geophysics*, 81 (2016), pp. M55–M69.
- [7] F. FAUCHER, Contributions to seismic full waveform inversion for time harmonic wave equations : stability estimates, convergence analysis, numerical experiments involving large-scale optimization algorithms, PhD thesis, Université de Pau et Pays de l'Adour, 2017.
- [8] C. SCRUBY AND B. MOSS, Non-contact ultrasonic measurements on steel at elevated temperatures, *NDT & E International*, 26 (1993), pp. 177–188.
- [9] A. TARANTOLA, Inversion of seismic reflection data in the acoustic approximation, *Geophysics*, 49 (1984), pp. 1259–1266.
- [10] J. VIRIEUX AND S. OPIKTO, An overview of full-waveform inversion in exploration geophysics, *Geophysics*, 74 (2009), pp. WCC1–WCC26.

Pulsed-laser source : Application

Tomography on a carbonate core

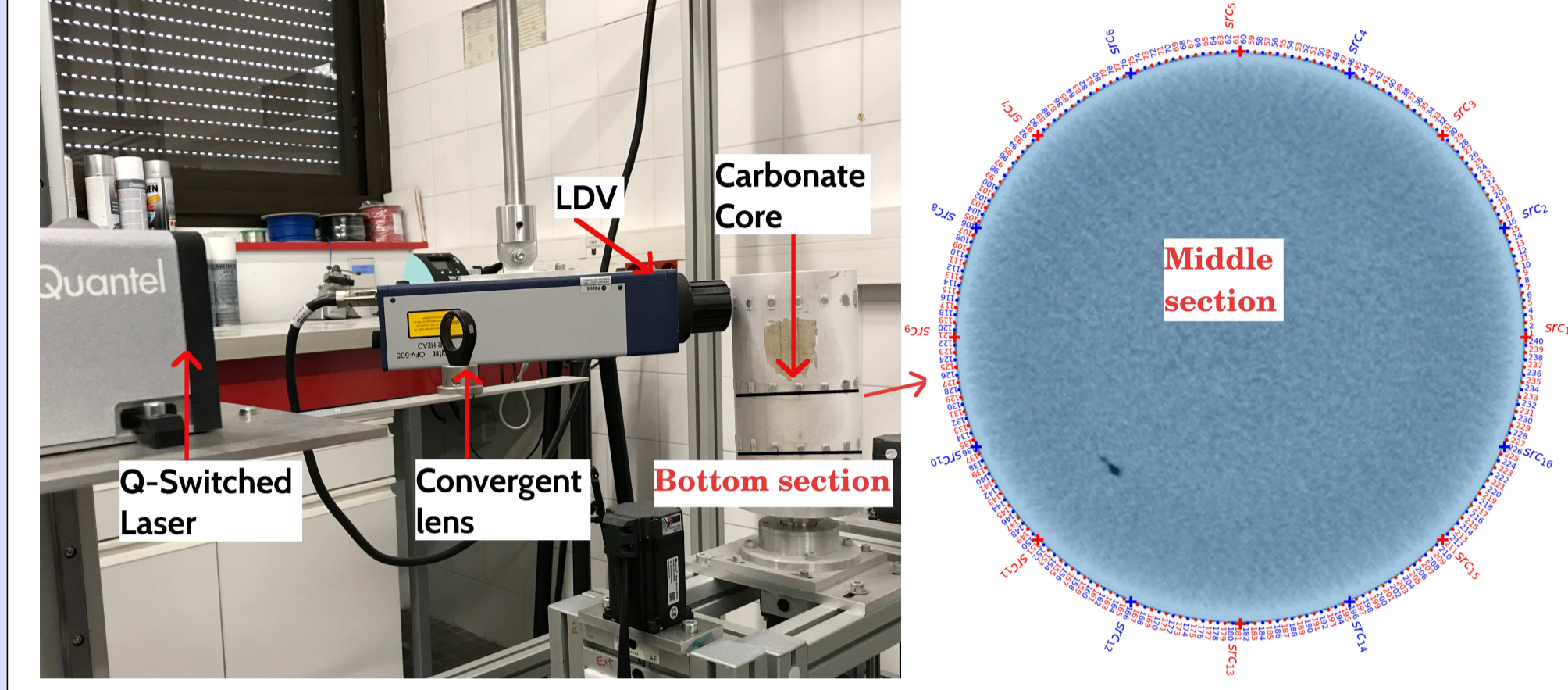

Application of the pulsed-laser ablation source on a carbonate core ($\Phi \approx 120$ mm). We used the point-source point-receiver setup. 16 sources (aluminum flakes) are uniformly distributed along the circumference of each normal section. Each source covers 300° (101 receivers @ 3°) in a symmetric manner. Thousands of shots are received by each source flake due to averaging recording.

First arrival time base tomography

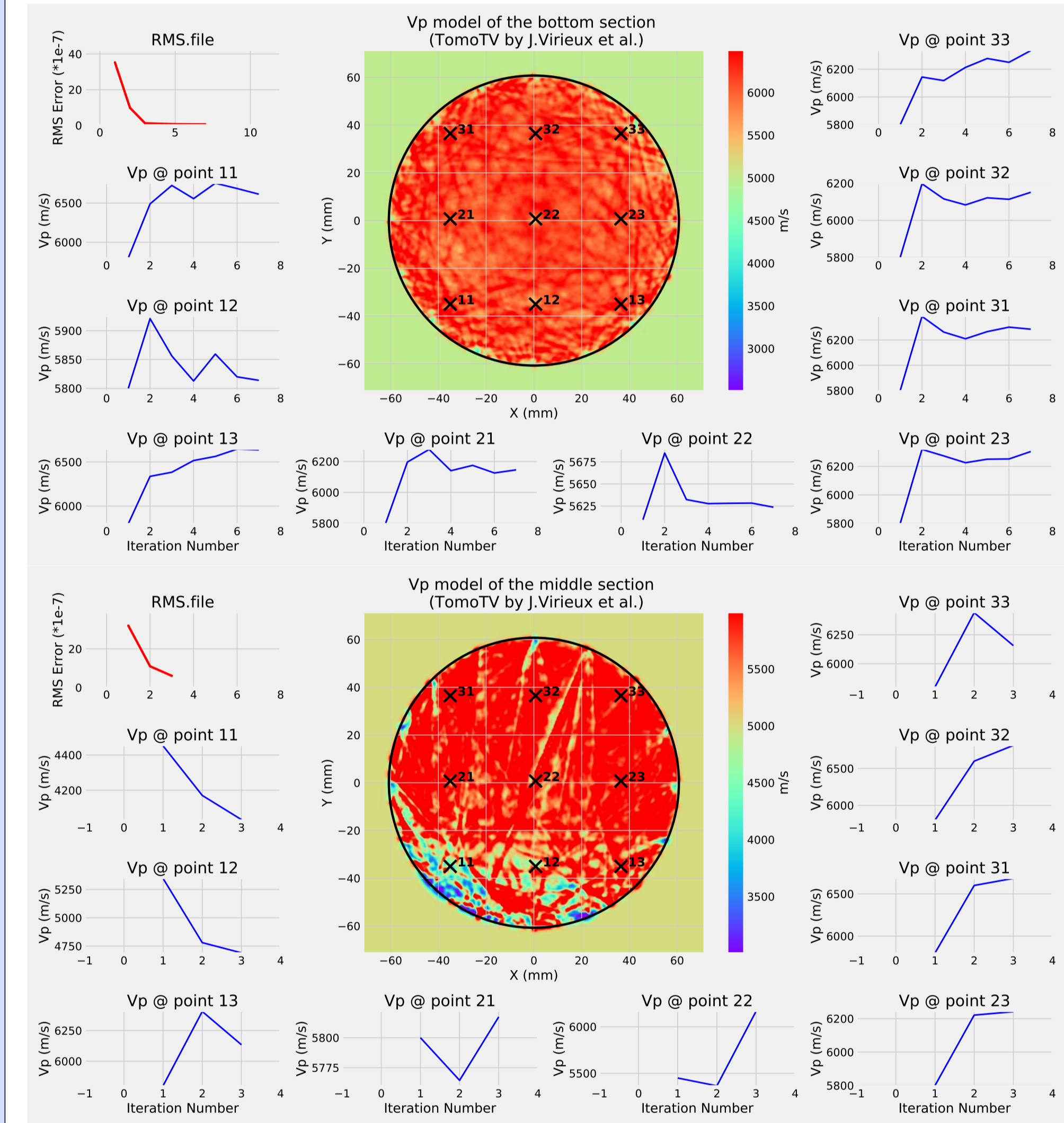

Considerable diffractions caused by the cavity disturbs heavily the first arrival time (2^{nd} Tomo). The first break based inversion algorithm doesn't take into account this complicated phenomenon, leading to noisy, unstable and hardly convergent results.

Toward Full Waveform Inversion (FWI) ?

The idea of Full Waveform Inversion (FWI) is to perform a quantitative reconstruction of the physical parameters, [9, 10]. It is based on an iterative minimization of the residuals, defined as the difference between the observations and simulations, in order to recover the medium parameters (i.e. velocity, density). The problem writes as

$$\min_m \mathcal{J}(m) = \frac{1}{2} \|d - F(m)\|^2, \quad (1)$$

where \mathcal{J} is the cost function, d the observed seismogram and $F(m)$ are simulations using an initial model m . We wish to employ the code that has been developed in [7], in particular starting with an initial model obtained from tomography. We illustrate in the figure below the observed and simulated traces for a single source. The deployment of iterative minimization would increase the accuracy of the velocity reconstruction, and allow a more precise characterization of the core interior.

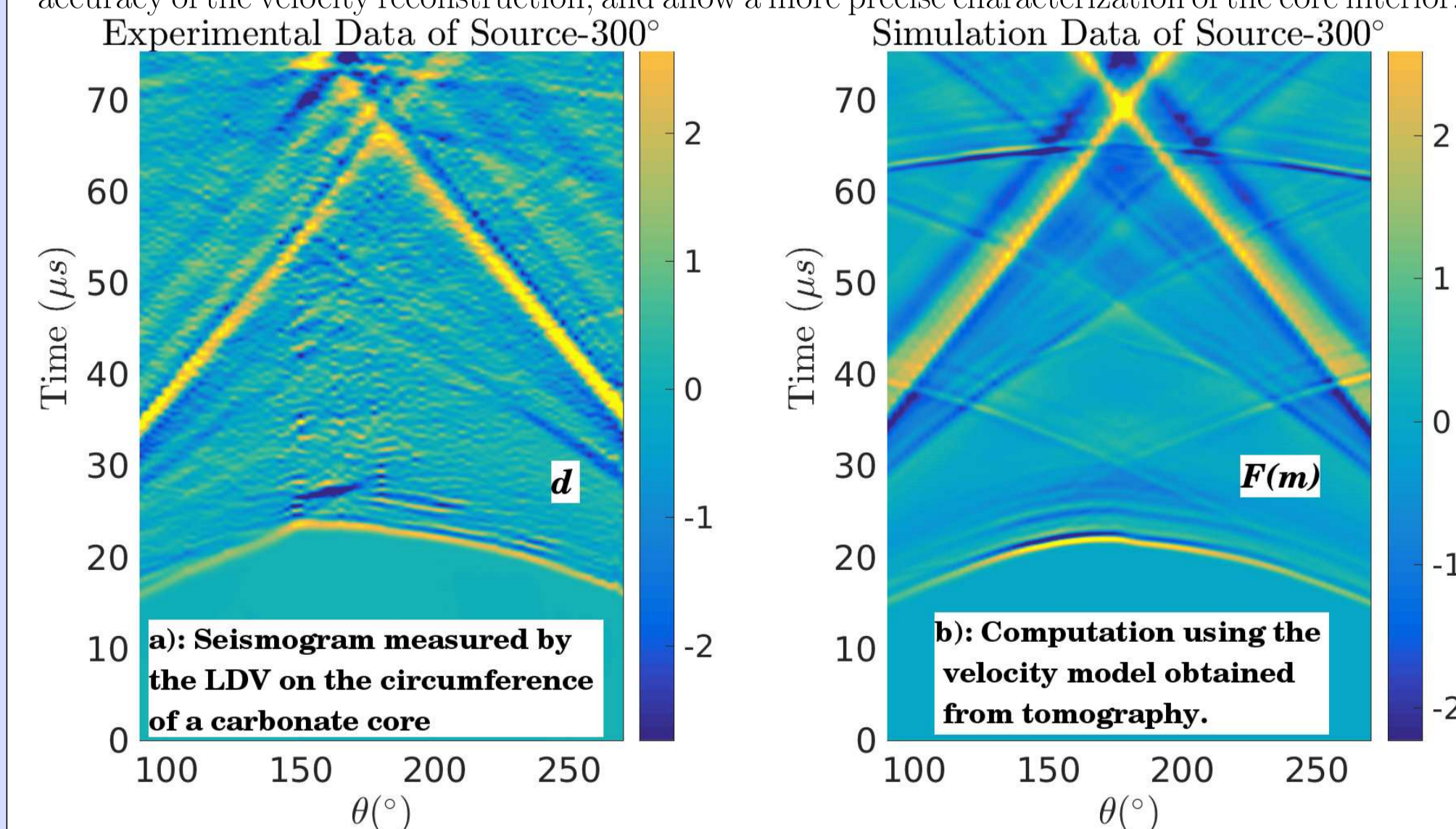

Conclusion :

This laser-generated seismic source opens new perspectives on various applications such as precise **Non-Destructive Test** on metals under high temperatures[8], micro-seismic exploration on small and intermediate scale samples of **random shapes** in the laboratory etc. We are especially interested in its eventual **geophysical applications** in rock mechanics [6], rocks or digital rocks imaging for geological reservoirs explorations. The laser-impulsed source appears to be well **controllable, flexible and reproducible** under some precautions. The combination of the pulsed-laser source and the LDV is particularly adapted to generate **broadband seismic full wavefields** in heterogeneous natural rocks. The punctual feature of the source makes it convenient to model and implement into numerical schemes. We aim at performing FWI with these data and further more, doing amplitude/frequency related analyses for anisotropy[2], attenuation and poroelasticity etc.