



HAL
open science

Fatigue safety verification of a steel railway bridge using short term monitoring data

Bartlomiej Sawicki, Eugen Brühwiler, Mariia Nesterova

► To cite this version:

Bartlomiej Sawicki, Eugen Brühwiler, Mariia Nesterova. Fatigue safety verification of a steel railway bridge using short term monitoring data. IALCCE 2018, 6th International Symposium on Life-Cycle Civil Engineering, Oct 2018, Ghent, Belgium. 8 p. hal-01955868v2

HAL Id: hal-01955868

<https://hal.science/hal-01955868v2>

Submitted on 13 Apr 2021

HAL is a multi-disciplinary open access archive for the deposit and dissemination of scientific research documents, whether they are published or not. The documents may come from teaching and research institutions in France or abroad, or from public or private research centers.

L'archive ouverte pluridisciplinaire **HAL**, est destinée au dépôt et à la diffusion de documents scientifiques de niveau recherche, publiés ou non, émanant des établissements d'enseignement et de recherche français ou étrangers, des laboratoires publics ou privés.

Fatigue safety verification of a steel railway bridge using short term monitoring data

B. Sawicki & E. Brühwiler

Laboratory of Maintenance and Safety of Structures (MCS), École Polytechnique Fédérale de Lausanne (EPFL), 1015, Lausanne, Switzerland

M. Nesterova

Laboratoire Expérimentation et modélisation pour le génie civil et urbain (EMGCU), The French institute of science and technology for transport, development and networks (Ifsttar), 77420, Champs-sur-Marne, France

ABSTRACT: The case study of the fatigue safety examination of the 120 years old steel riveted bridge carrying a single railway track on two main girders is presented. The overall assessment according to the Swiss Standard SIA 269 for existing structures indicated sufficient resistance at Ultimate Limit State but not at Fatigue Limit State, and the replacement of girders was recommended. To challenge this, the detailed examination was performed using data obtained from short term monitoring by the system installed on the main girders of one span over a period of four weeks. Fatigue stress histograms were constructed, and it was shown that measured stress ranges are smaller than the fatigue endurance limit, indicating a theoretically infinite fatigue life. No structural intervention is thus necessary. This case study shows that a simple short term monitoring is very useful for the fatigue examination of bridges allowing for reducing or avoiding (costly) interventions on structures.

1 INTRODUCTION

A riveted steel bridge located in Switzerland was built in 1897 and is composed of an arch of 48m span and approach viaducts. Columns support girders approximately every 10m over a total bridge length of 79.1m. The girders carry a single normal gauge railway open track (sleepers are directly fixed on the steel structure) for bi-directional passenger trains (Fig. 1).



Figure 1 The railway bridge with the scaffolding for installation of monitoring.

The superstructure consists of two girders built-up as double T girders from plates and L-shaped elements riveted together. The girder-to-girder connection is a butt joint formed of L-angles over the web height only, while the flanges are discontinuous. The structural and fatigue safety of the bridge was initially evaluated by “re-calculation” using the Swiss standards SIA 269 for existing structures. While sufficient structural safety at ULS resistance was found, the fatigue safety was evaluated to be insufficient. Consequently, intervention was recommended.

It is well known that fatigue safety assessment of existing bridges based on “re-calculation” using current code provisions are over-conservative, usually resulting in calculated insufficient fatigue safety triggering, sometimes, invasive interventions. This unsatisfactory situation is a theoretical, pseudo-scientific “problem on paper” and does not reflect the real performance of the existing bridge.

Subsequently, it was decided to conduct a monitoring campaign in order to measure effective fatigue stresses in fatigue relevant details. This paper reports on the results.

2 MONITORING SET-UP

The aim of monitoring was to measure the stress variation at specific locations of the girders and to estimate the structural response under the train loading action. The first span from the abutment was se-

lected for the monitoring since the expected bending moments were highest, and for the sake of accessibility.

Both girders were instrumented using electrical strain gauges. Two cross-sections were instrumented with three strain gauges each (Fig. 2). Cross section 1 was located at mid-span of the girder, while Cross-

section 2 was - as close to support as possible but outside of the joint area.

Strains were measured with a frequency of 300 Hz, and the measurement duration was 17 s per train. During the 4 weeks of monitoring, the strain histories of about 2'200 trains were recorded.

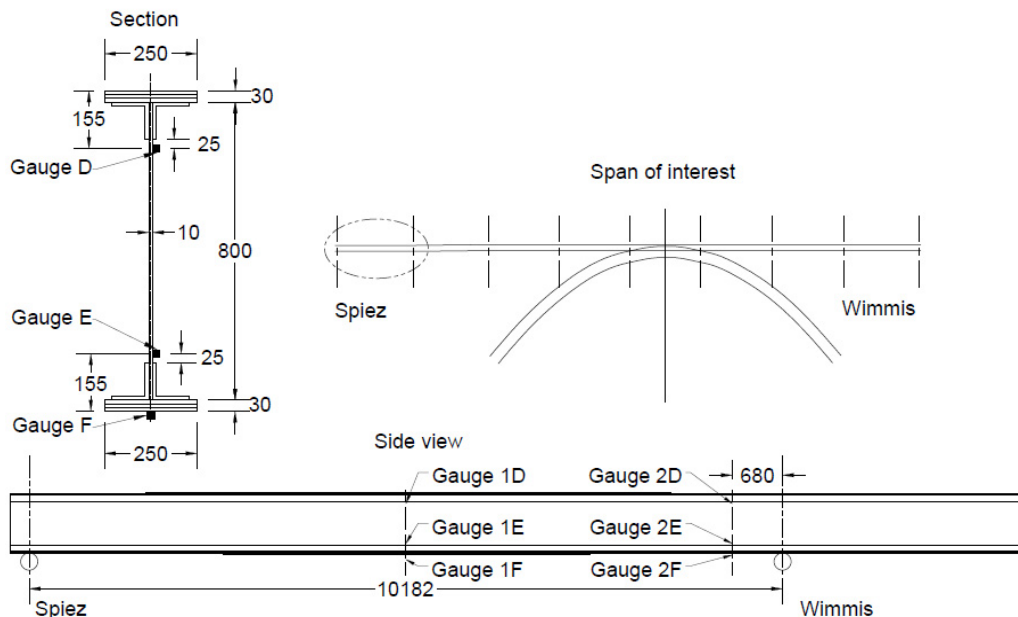

Figure 2 The scheme of monitoring. Dimensions in mm.

3 MEASURED ACTION EFFECTS

3.1 Data treatment

From the measured signals, the effects of train traffic were extracted by using the signal from the unloaded structure as zero value. In the present case, strain amplitudes due to temperature variation were not considered because of the short measurement dura-

tion of each train passage. Also, they do not contribute to fatigue damage (Treacy, 2014).

3.2 Nature of traffic on the bridge

The entire set of recorded signals due to train passages, transformed into stress values using a modulus of elasticity of 210GPa, is presented in Figure 3 where the maximum value for each train is marked.

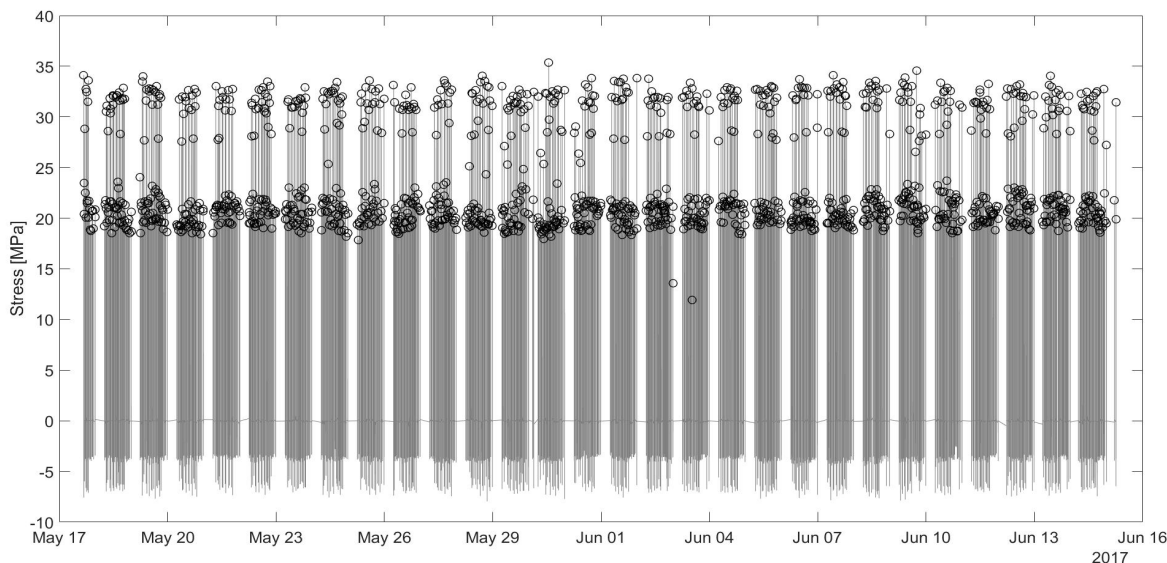

Figure 3 Stresses as obtained from all recorded trains during the monitoring. The marks show the maximum value per train.

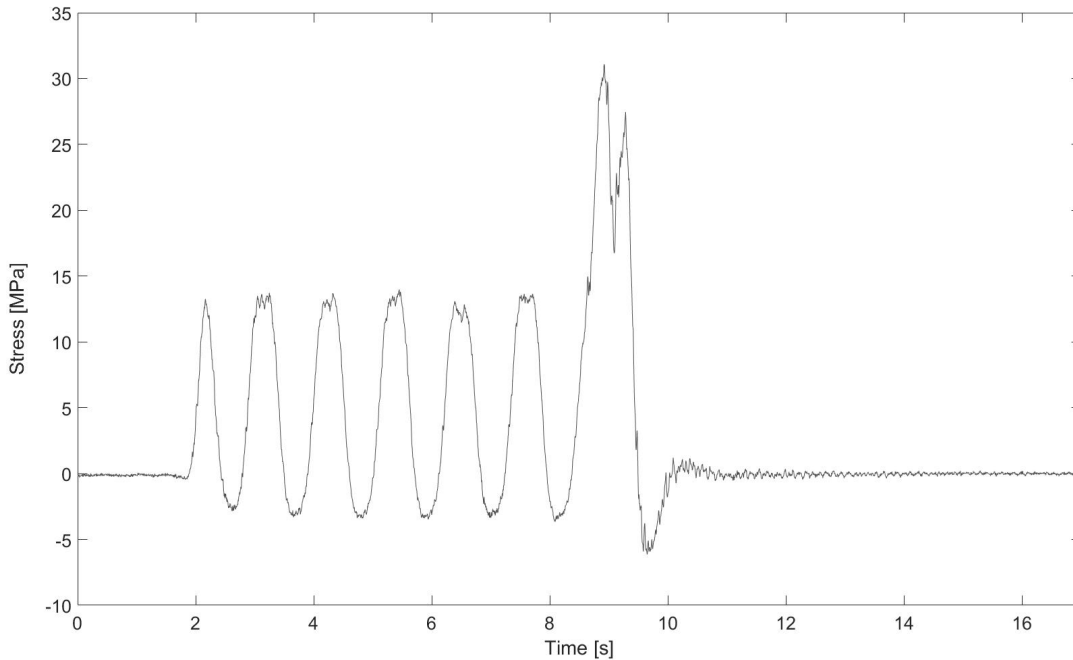

Figure 4 Stresses obtained from strains registered by gauge 1F during passage of train composed of the locomotive (pushing) and 5 cars.

Counting the peaks of each recorded strain history allowed determining the number of axles per train and thus the train type. The identified train types are given in Figure 5 showing the distribution of the rolling stock operating as follows:

- 4 cars, i.e. four module trains, further referred to as A-type
- 4+4 (4+3) cars, i.e. train composed of two four-module or three- and four-module A-type trains
- Locomotive + 5 cars, i.e. train composed of the locomotive and 5 cars

- Locomotive, i.e. locomotive without cars
- Long train, i.e. train that could not be classified to any of above, probably with more passenger cars than 5.

When the histogram of extremes per train is plotted with distinction between train types (Fig. 5), the clear difference can be found between the Type A trains and the ones hauled by a locomotive. This is because of the much higher weight of the power car.

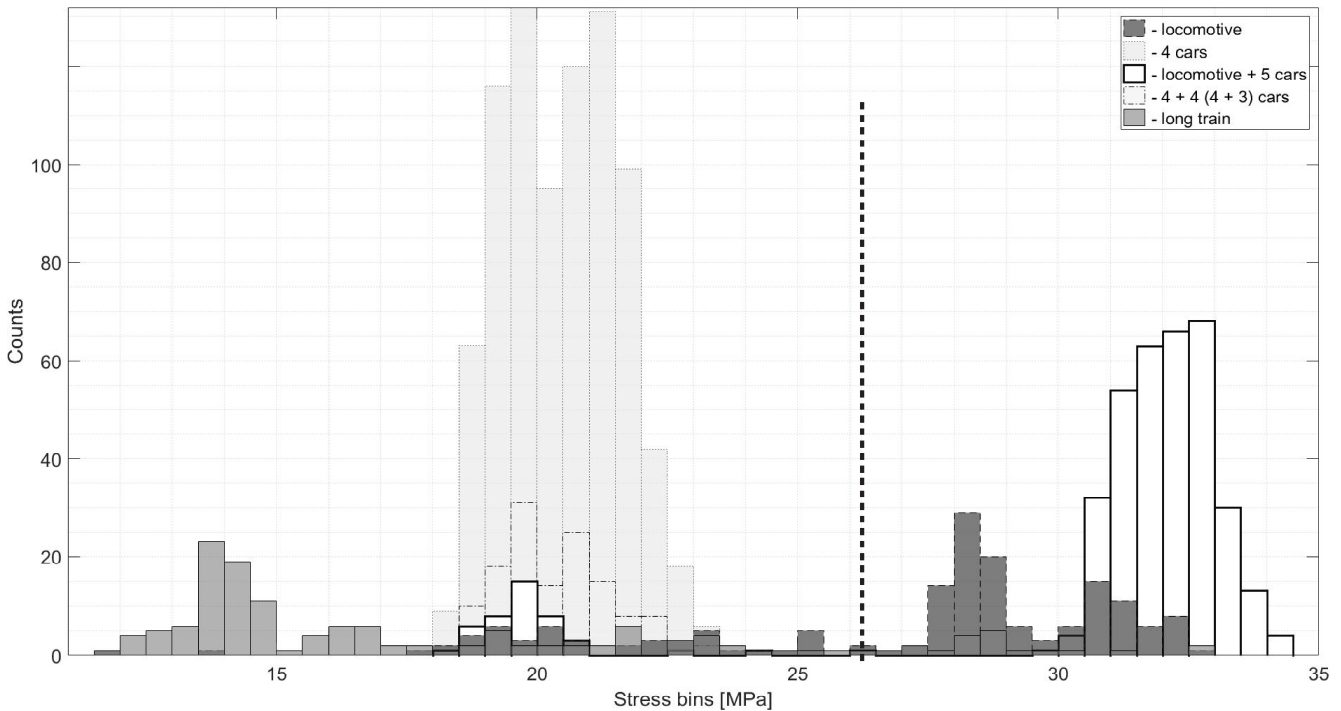

Figure 5 Histogram with division into train types. The border between two types of trains is marked with dashed line.

3.3 Verification of monitoring duration

To verify whether the monitoring duration of 4 weeks was long enough to obtain reliable results, evaluation using an Extreme Value Theory (EVT) was conducted.

Given that a clear border exists between light multiple unit A-type trains (with recorded stresses below 27.5 MPa) and trains with locomotives (with stresses higher than 27.5 MPa), the two data sets were treated separately.

The threshold for tail fitting was chosen using Mean Residual Life plot. It was set to 21.5 MPa for first group and 32.5 MPa for the second one.

It was found that the return levels for the return period were close to the measured values (Fig. 6). This was expected, as the railway traffic is highly consistent and repetitive. Also, there was no isolated extreme event as can often be observed for road bridges (Treacy, 2014). This confirms also that the monitoring campaign was sufficiently long

3.4 Dynamic amplification

The dynamic amplification effects are largely over-estimated in existing codes (Ludescher, 2003). For the investigated span (10.4m) the amplification factor according to European Standards is equal to 1.30, understood as an increase in vertical forces of 30%.

The amplification of loads due to dynamic effects of moving trains depends not only on the length of the span, but also on the velocity and weights of the trains. When comparing the recorded strain histories

of same types of trains travelling at different times (thus possibly with different velocities), similar structural responses were found. Furthermore, the peak stresses due to passages of the subsequent axles of the same train were similar (Fig. 4).

Consequently, no amplification due to dynamic interaction between the moving trains and the bridge structure was found, despite the fact that the railway track is opened. The continuous rails of good rolling quality may explain this favourable result.

The above leads to the conclusion that the dynamic amplification effects are negligible and, as such, are included in the monitoring results. No further consideration of dynamic effects is needed.

3.5 Structural response

During the “re-calculation”, it was assumed that each span acts as a simply supported beam and the girder-to-girder joint is a hinge.

The measurements revealed compressive strains at Gauge 2F (bottom of the beam, Fig. 2), indicating that a hogging moment exists near the supports. Figure 7 shows exemplary strain profiles over the height of the sections due to a random train passage. The measured strains are indicated with dots and the linear strain distribution is extrapolated over the entire height. A hogging moment for the section closer to the support is evident.

This means that the girder system acts similar to a continuous beam system. Consequently, the degree of fixity of connection was investigated

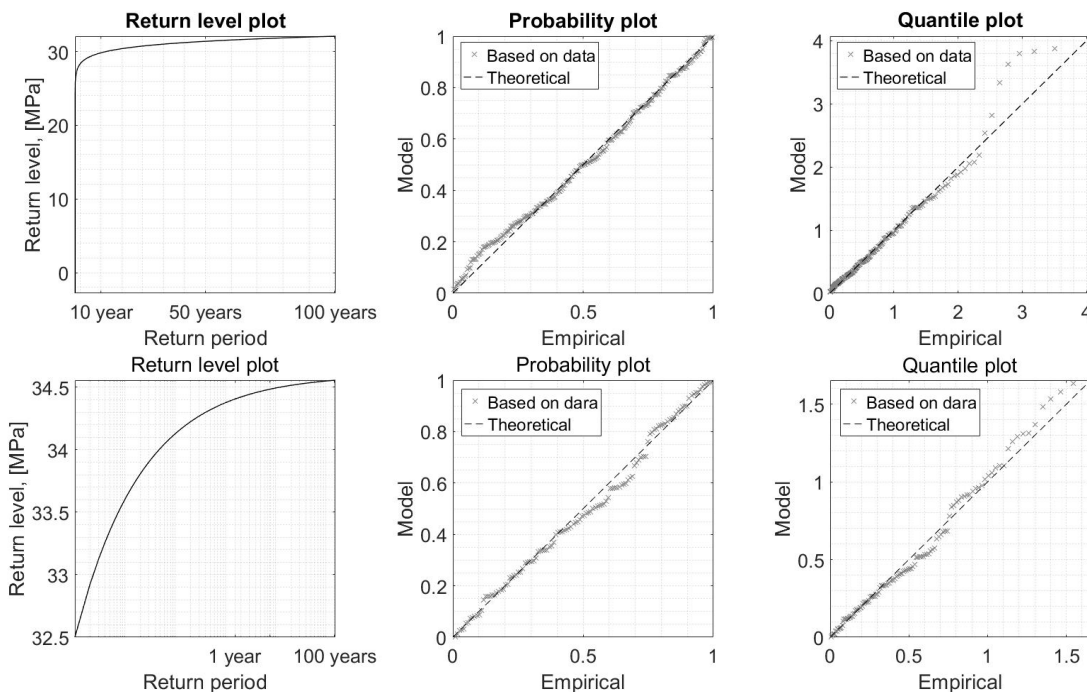

Figure 6 Return levels plots and goodness of fit for two sets of trains (27.5 MPa threshold).

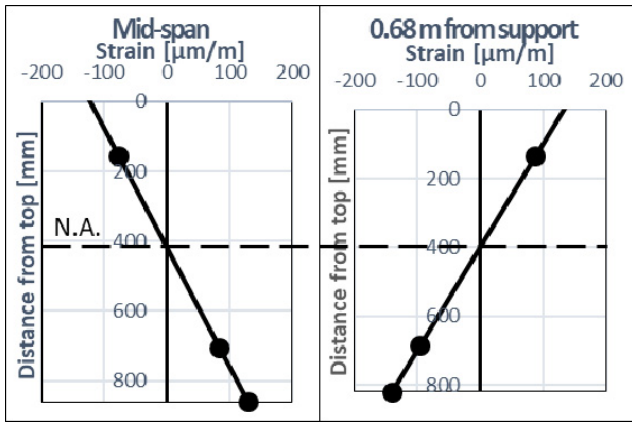

Figure 7 Strain distribution in cross-section due to train passage. Values measured by gauges are marked.

Since the joint between two adjacent girders has some fixity, the loading on each span produces responses in the other. To compare the measured stresses with the results of structural analysis, the direction of train passage had to be considered. Passages of the trains coming from the abutment on the bridge were selected. Stresses were identified at the exact instant when the first boogie of the train was above the mid-span, providing the maximum stress there. Next, the ratio between stresses at the bottom of the girder were compared in the two monitored sections (gauges 1F and 2F). This ratio is depending mostly on the degree of fixity of the connection, and in average was equal to $R=-0.25$. The ratio is negative because the moment is changing from sagging to hogging.

3.6 Beam model

One girder of the monitored span was modelled by means of the ROBOT® Structural Analysis software using beam elements. At one end, a pinned support was modelled, and at the other end a vertical support and rotating spring. The rotating spring was simulating the fixity due to the girder-to-girder connection.

Because the stress variation due to train passage was measured, only the train loading was modelled. The first boogie of the Type A train was used, since this is the most common train on this line. Then, the rotating spring was tuned such as to obtain the same response as the measured one. Stiffness from 0, i.e. pinned support, up to infinity, i.e. clamped or full fixity, was used. The determined variation of stress ratio depending on spring stiffness is given in Table 1 with the best fit value in bold. The physical meaning of the numbers in terms of structural response is analyzed below.

Table 1. Stress ratio depending on spring stiffness.

Spring stiffness kNm/deg	Spring stiffness	Stress ratio
	MNm/rad	
0	0	0.29
1800	103	-0.18
2200	126	-0.25
2500	143	-0.30
Infinity	Infinity	-2.11

3.7 Modelling of the girder-to-girder connection

The girder-to-girder connection was modelled using the commercial FEM package Idea StatiCa® connection module. All plates and elements were modelled with shell elements. The transfer of forces due to contact was enabled and the rivets were modelled as pre-tensioned bolts. The sectional forces found from the beam model were applied, i.e. $M = 59$ kNm and $V = 53$ kN.

In opened-deck railway bridges, continuous rails contribute to the structural behaviour (Herwig, 2008). To model this contribution, the slip and stiffness of sleepers and connectors need to be known. As no precise information was available, this contribution was estimated by modelling the rail being attached with C-shaped steel profiles to the girder, as shown in Figure 8. The results are presented in Table 2.

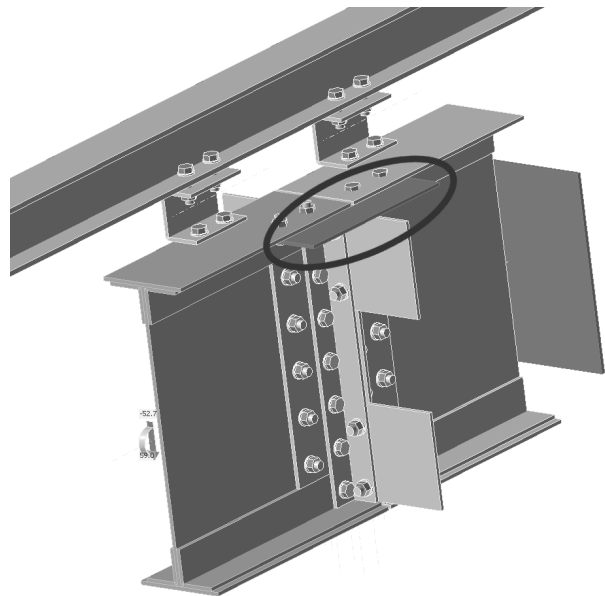

Figure 8 FEM of the connection with the transversal truss connecting plater marked.

Table 2. Stiffness of modelled joint.

Connection	$S_{j,ini}$ (initial stiffness)	$S_{j,s}$ (secant stiffness)
	MNm/rad	MNm/rad
No rail	38.4	41.5
With cont. rail	67.2	87.1

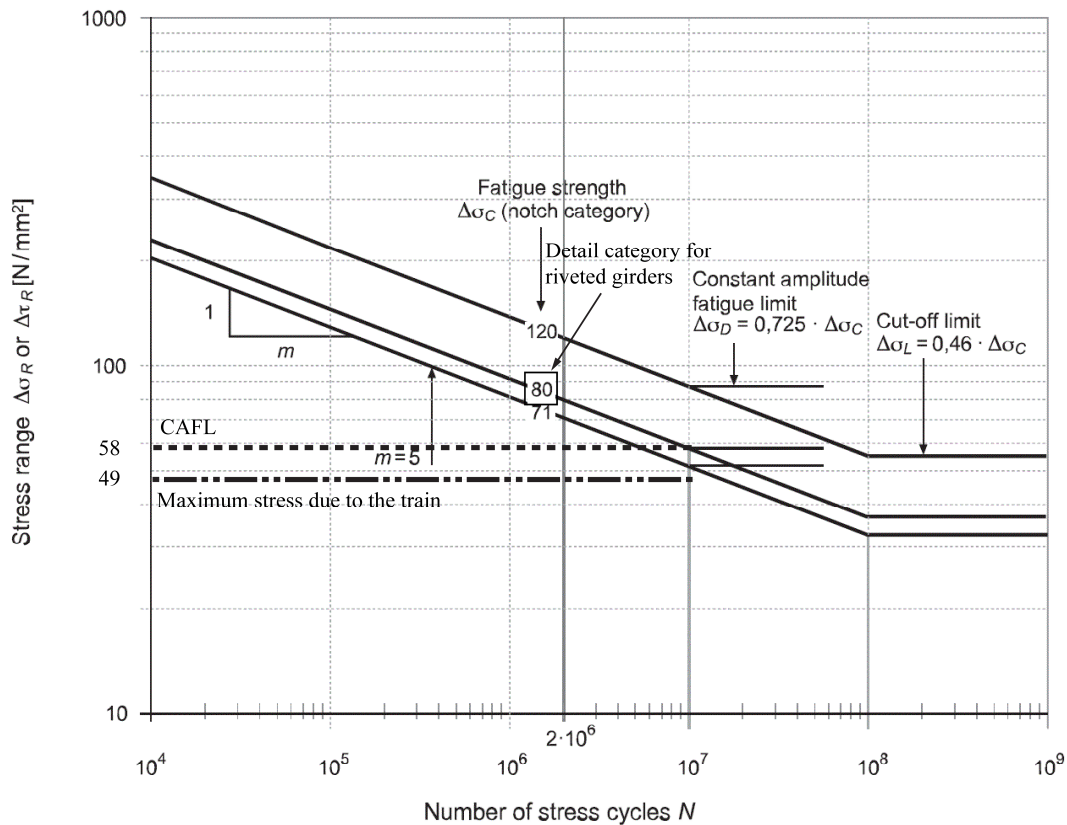

Figure 9 S-N curve from SIA 269 for riveted details with stress range in girder.

In the model, only one rail to girder connection was used for each span, which is significantly increasing the stiffness. When using stiffer connectors or a higher number of those, like in the structure, the stiffness found from the beam model could be easily obtained. Such modelling was however not performed since no information on the connector's stiffness was available. Still, the model of connection allowed for the verification of the beam model's results.

3.8 Findings from the stiffness modelling

The partial fixity of the girder was proven, and thus the assumption taken during the "re-calculation" was not correct. The distribution of moments along the girders shows significantly smaller bending moments at mid-span than the initially "re-calculated" ones.

Table 3 gives the comparison of bending moment distributions along the girder with different degrees of fixity. The following cases are considered:

- Discontinuous, i.e. no connection with adjacent span, simply supported bridge
- Monitored bridge, i.e. with same degree of fixity as in the bridge, stiffness from model found above

- 3 point continuous, i.e. multispan beam with point load in the middle
- 4 point continuous, i.e. multispan beam with two point loads spaced at 1/3 span
- Fixed, i.e. beam clamped over the support.

The loading due to Type A train's first boogie was used, and positive moments are sagging.

The results indicate that the fixity is partial, and the static scheme of the girder is between the two cases: simply supported and continuous beam. Therefore, the bending moment at mid-span is 16% smaller for the real static scheme comparing to the simply supported beam.

Table 3. Moment distribution for different static schemes.

Case	Moment mid-span kNm	Moment over support kNm	Moment ratio -
Discontinuous	185	0	0
Monitored bridge	156	-59	-0.38
3 point continuous	169	-156	-0.92
4 point continuous	118	-138	-1.17
Fixed	114	-143	-1.25

4 FATIGUE SAFETY OF THE BRIDGE

4.1 Methodology

According to the more than 30 years old approach in the domain of fatigue safety, several levels of verification are performed with the objective to verify sufficient fatigue safety and to avoid construction interventions.

Level 1 verification with respect to the fatigue limit, is the simplest and most difficult verification. If Level 1 verification fails, Level 2 has to be performed.

Level 2 is more complex as it includes the determination of an equivalent fatigue stress (considering fatigue stress spectra) that is compared to the fatigue strength (fatigue detail category).

Level 3 verification includes explicit fatigue damage accumulation using Palmgren-Miner Rule.

Level 4 verification is based on Linear Elastic Fracture Mechanics to calculate fatigue crack propagation due to fatigue stresses and comprises explicit consideration of inspection methods (to detect fatigue cracks) and their intervals.

Construction interventions like strengthening or replacement of fatigue critical elements are only conducted if the fatigue verification at the highest Level is not fulfilled. Consequently, if the fatigue safety verification at a lower level is fulfilled, no higher level verification is needed.

This methodology is prescribed in the Swiss Standards SIA 269 for Existing Structures and was applied in the present case.

4.2 Fatigue safety verification on Level 1

On Level 1, the fatigue action effect is described by the maximum fatigue stress range that is compared with the Constant Amplitude Fatigue Limit (CAFL) describing the fatigue resistance.

Fatigue action effects:

Using the measured stresses histories, histograms were produced using the Rainflow counting method. The histogram for the bottom of the girder at mid-span (gauge 1F), showing the highest stress values, is presented in Figure 10.

The cumulative histograms after each week of measurements remained consistent, thus indicating that one week of monitoring would have been sufficient to obtain reliable results from the present regular passenger train traffic. The first bin, from 0 to 5 MPa, contains mostly measurement noise and was disregarded.

Since the monitored span was the longest of the entire bridge and the first span, the highest stress variations could be expected.

Because the girder does not act as a simply supported beam, the maximum moment is not located at

the mid-span. From the beam model it could be deduced that the maximum stress ranges were about 5% higher than the measured ones at mid-span, so this increase has to be taken into account.

For the determination of fatigue relevant stresses in riveted members, the net section stress outside the riveted detail must be considered (i.e., no “hot spot” stress must be determined !). The gauges were thus intentionally not aligned with rivets in order to measure uniform gross section stresses. For the fatigue safety verification, the measured stresses are increased by 10% to account for net section stresses. However, the change of stress from gross to net section is not immediate, so this increase is quite conservative.

The standard SIA 269 allows for disregarding fatigue actions applied historically before year 1940 as historic train loads were smaller. The owner assured that cargo trains that can lead to stresses higher than measured are not operated on the line. However, the isolated event of a heavy train is not relevant in terms of fatigue loading.

The induced maximum fatigue stress range is $\Delta\sigma_{\max} = 42.5 \text{ MPa} \times 1.05 \times 1.10 = 49 \text{ MPa}$.

Fatigue resistance:

The constant amplitude fatigue limit (CAFL) is used in the present case. According to SIA 269/3 the detail category is 80MPa for riveted girders. As the girder can be inspected, the partial factor $\gamma_{Mf,act} = 1.0$; leading to the CAFL: $\Delta\sigma_{D,80} = 58 \text{ MPa}$.

Fatigue safety verification:

Thus, the highest fatigue stress range in the girder is below the CAFL (Fig. 9) and no further verification is needed. The fatigue safety is verified and no intervention is justified.

4.3 Comment regarding the connection:

The girder-to-girder connection was shown to act as a semi-rigid connection. Consequently, stresses due to the train loading are transferred through the joint formed by the plate connecting the transversal truss to the girder (marked in Figure 8 with an oval), the vertical angle profiles forming the butt-joint and the continuous rail. Refined structural analysis indicated rather high fatigue stresses locally. However, local fatigue damage leading to failure of the joint is acceptable as it would only lead to a change in the static system to the (initially assumed) isostatic system. Such a change should be detected by inspection.

Previous inspections did not reveal any indication of a fatigue damage in these details. In addition, it is planned to add a lamella to realize a continuous upper flange that will effectively strengthen the girder-to-girder connection.

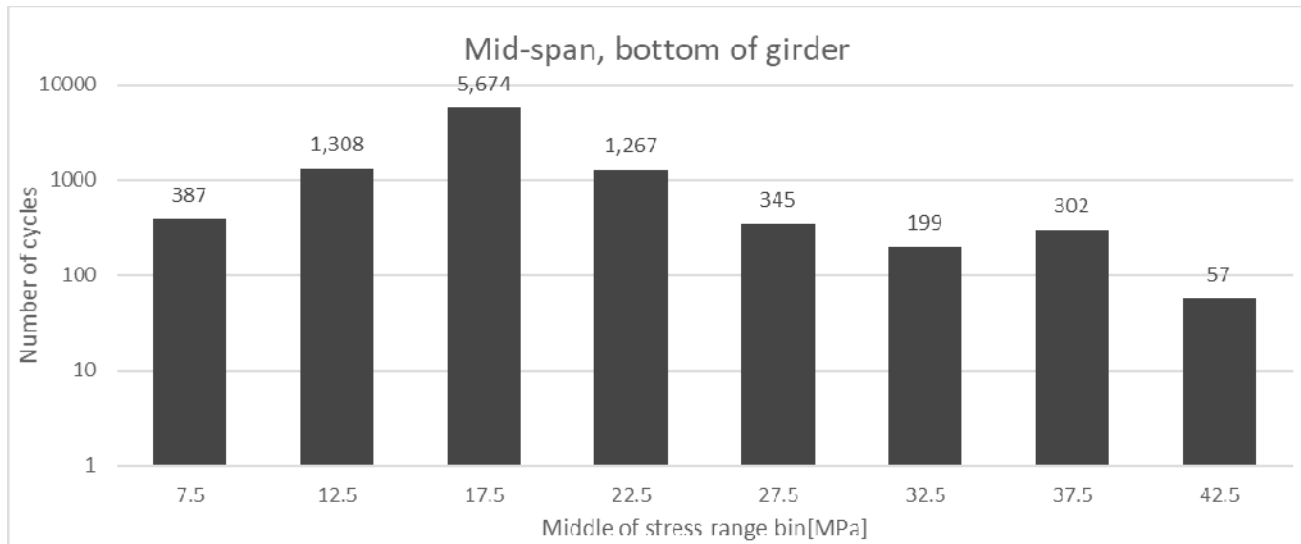

Figure 10 Stress variation histogram, 28 days of monitoring, gauge 1F.

5 CONCLUSIONS

Data from short term monitoring was used to examine the fatigue safety of fatigue critical details of a riveted steel railway bridge. The following conclusions are obtained:

1. The monitoring allowed to determine real structural behaviour and realistic fatigue relevant stresses. It also eliminated the need for application of codified load models which are not appropriate for realistic fatigue safety verification.
2. In addition, uncertainty in structural behaviour could be reduced and refined numerical structural models could be calibrated to account for real structural behaviour. Monitoring thus allows to gain more precise and realistic information than “re-calculation”.
3. The utilized simple monitoring set-up turned out to be relatively easy to install and robust, leading to reliable readings.
4. Overall, examination by means of data from monitoring is economic since sufficient fatigue safety could be proven, and thus no intervention is needed, while conventional “assessment” by “re-calculation” recommended strengthening.

6 REFERENCES

- Herwig, A. 2008. Reinforced concrete bridges under increased railway traffic loads. Doctoral thesis. École Polytechnique Fédérale de Lausanne
- Ludescher, H. 2003. Berücksichtigung von dynamischen Verkehrslasten beim Tragsicherheitsnachweis von Strassenbrücken (in German). Doctoral thesis. École Polytechnique Fédérale de Lausanne
- Treacy, M.A. 2014. The use of monitored data in the verification of structural and fatigue safety of existing post-

tensioned concrete highway bridges. Doctoral thesis. École Polytechnique Fédérale de Lausanne

7 ACKNOWLEDGEMENT

This project has received funding from the European Union’s Horizon 2020 research and innovation program under the Marie Skłodowska-Curie grant agreement No 676139.